

## TABLE OF CONTENTS

<b>CHAPTER 5 DESIGN ELEMENTS</b>	<b>5-1</b>
<b>5.1 GEOMETRIC DESIGN OF SUBDIVISION STREETS</b>	<b>5-1</b>
5.1.1 Geometric Design of Subdivision Streets - General	5-1
5.1.2 Geometric Design of Subdivision Streets - Design Criteria	5-2
5.1.3 Geometric Design of Subdivision Streets - Intersection Design	5-2
5.1.4 Geometric Design of Subdivision Streets - Parking Provisions	5-6
5.1.5 Geometric Design of Subdivision Streets - Dead End Streets	5-6
5.1.5.1 Permanent Dead End Streets	5-6
5.1.5.2 Temporary Dead End Streets	5-7
5.1.6 Geometric Design of Subdivision Streets - Traffic Calming	5-11
<b>5.2 SUBDIVISION AND COMMERCIAL ENTRANCE DESIGN GUIDELINES</b>	<b>5-11</b>
5.2.1 Subdivision and Commercial Entrance Design Guidelines – Process	5-13
5.2.2 Subdivision and Commercial Entrance Design Guidelines – Entrance Location	5-14
5.2.3 Subdivision and Commercial Entrance Design Guidelines – Design Vehicle	5-16
5.2.4 Subdivision and Commercial Entrance Design Guidelines – Entrance Width	5-17
5.2.5 Subdivision and Commercial Entrance Design Guidelines – Intersection Corner Radii	5-19
5.2.5.1 Simple Curve Radius	5-22
5.2.5.2 Simple Curve Radius with Taper	5-25
5.2.5.3 Three Centered Compound Curves	5-27
5.2.5.4 Turning Roadways	5-29
5.2.5.5 Channelizing Islands	5-35
5.2.5.6 Turning Movement Diagrams	5-37
5.2.6 Subdivision and Commercial Entrance Design Guidelines – Entrance Length	5-38
5.2.7 Subdivision and Commercial Entrance Design Guidelines – Horizontal Alignment	5-40
5.2.8 Subdivision and Commercial Entrance Design Guidelines – Vertical Alignment	5-41
5.2.9 Subdivision and Commercial Entrance Design Guidelines – Auxiliary Lanes	5-44
5.2.9.1 Right-Turn Lane	5-44
5.2.9.2 Bypass Lane	5-46
5.2.9.3 Left-Turn Lane	5-51
5.2.9.4 Crossover	5-56
5.2.10 Subdivision and Commercial Entrance Design Guidelines – Bike Lanes	5-61
<b>5.3 PEDESTRIAN FACILITIES</b>	<b>5-61</b>
5.3.1 Pedestrian Facilities - Sidewalks	5-61
5.3.1.1 Placement	5-61
5.3.1.2 Material	5-62
5.3.1.3 Ramps	5-62
5.3.2 Pedestrian Facilities - Shared Use Path	5-64
5.3.2.1 Design Criteria	5-64
5.3.2.2 Intersections	5-64
5.3.3 Transit Stop Design	5-65
<b>5.4 SIGHT DISTANCE</b>	<b>5-65</b>
<b>5.5 TYPICAL SECTIONS</b>	<b>5-67</b>
5.5.1 Typical Sections - Pavement Widths	5-67
5.5.2 Typical Sections - Curbs	5-68
5.5.3 Typical Sections - Ditches and Sideslopes	5-73

## TABLE OF CONTENTS

5.5.4	Typical Sections - Underdrains.....	5-73
5.5.5	Typical Sections - Clear Zone .....	5-74
5.5.6	Typical Sections – Lateral Offset.....	5-74
<b>5.6</b>	<b>PAVEMENT SECTIONS .....</b>	<b>5-77</b>
5.6.1	Pavement Sections - Subdivision Streets .....	5-78
5.6.2	Pavement Sections - Entrances .....	5-80
5.6.3	Pavement Sections Industrial Streets / Entrances .....	5-81
5.6.4	Pavement widening .....	5-81
<b>5.7</b>	<b>SUBDIVISION DRAINAGE DESIGN .....</b>	<b>5-83</b>
5.7.1	Subdivision Drainage Design - General.....	5-83
5.7.2	Subdivision Drainage Design - Drainage Criteria .....	5-83
5.7.2.1	Open Channels .....	5-83
5.7.2.2	Culverts.....	5-83
5.7.2.3	Storm Sewers.....	5-84
5.7.2.4	Inlet Design .....	5-85
5.7.2.5	Pipe Cover .....	5-85
5.7.2.6	Drainage Easements .....	5-86
5.7.2.7	Drainage Design Report.....	5-87
5.7.2.8	Safety Grate for Pipe Inlet.....	5-88
5.7.3	Subdivision Drainage Design - Hydrology .....	5-88
5.7.4	Subdivision Drainage Design - Hydraulics.....	5-88
<b>5.8</b>	<b>STORMWATER MANAGEMENT.....</b>	<b>5-89</b>
<b>5.9</b>	<b>EROSION AND SEDIMENT CONTROL .....</b>	<b>5-90</b>
<b>5.10</b>	<b>STRUCTURAL DESIGN.....</b>	<b>5-90</b>
<b>5.11</b>	<b>SIGNING AND PAVEMENT MARKING DESIGN.....</b>	<b>5-91</b>
5.11.1	Signing and Pavement Marking Design-Signing .....	5-91
5.11.1.1	Placement of Signs .....	5-91
5.11.1.2	Specifications .....	5-91
5.11.1.3	Signs Required in Residential Development.....	5-91
5.11.2	Signing and Pavement Marking Design - Pavement Markings .....	5-93
<b>5.12</b>	<b>MAINTENANCE OF TRAFFIC.....</b>	<b>5-93</b>
<b>5.13</b>	<b>SIGNAL DESIGN.....</b>	<b>5-94</b>
<b>5.14</b>	<b>UTILITY DESIGN.....</b>	<b>5-95</b>
<b>5.15</b>	<b>LIGHTING DESIGN.....</b>	<b>5-96</b>

## TABLE OF CONTENTS

### LIST OF FIGURES

Figure 5.1.2-a Design Criteria for Subdivision Streets .....	5-2
Figure 5.1.3-a Intersection Design Radii .....	5-3
Figure 5.1.3-b Maintaining Major Street Crown through Intersection .....	5-3
Figure 5.1.3-c Vertical Alignment Guidelines .....	5-4
Figure 5.1.3-d Intersection Cross Slope Transition Example.....	5-5
Figure 5.1.4-a Subdivision Street Parking Provisions.....	5-6
Figure 5.1.5.1-a Design Radii for Cul-de-Sacs .....	5-7
Figure 5.1.5.2-a Design Alternatives in lieu of Cul-de-Sacs in Reduced Right-of-Way .....	5-9
Figure 5.1.5.2-b Stub Street Sign Detail.....	5-10
Figure 5.2-a Entrance and Intersection Design Elements.....	5-12
Figure 5.2.1-a Subdivision and Commercial Entrance Plan Decision Flow Chart .....	5-13
Figure 5.2.2-a Corner Clearance .....	5-15
Figure 5.2.2-b Avoiding Entrance Jog Maneuvers.....	5-15
Figure 5.2.2-c Desirable Offsets on Undivided Highways .....	5-16
Figure 5.2.3-a Design Vehicle Selection.....	5-17
Figure 5.2.4-a Poorly Designed Entrance Widths.....	5-18
Figure 5.2.4-b Entrance Pavement Widths .....	5-18
Figure 5.2.4-c Commercial Entrance Lane Width Example .....	5-19
Figure 5.2.4-d Separate Left and Right-Turn Exiting Lanes .....	5-19
Figure 5.2.5-a Typical Lane Encroachment by Design Vehicle .....	5-21
Figure 5.2.5-b Methods for Pavement Corner Design.....	5-22
Figure 5.2.5.1-a Effective Pavement Width Examples.....	5-23
Figure 5.2.5.1-b Simple Curve Radius with Effective Widths .....	5-24
Figure 5.2.5.1-c Simple Curve Radius Example for a SU-30 .....	5-25
Figure 5.2.5.2-a Simple Curve Radius and Taper .....	5-26
Figure 5.2.5.2-b Simple Curve Radius and Taper Example for a SU-30.....	5-27
Figure 5.2.5.3-a Three Centered Compound Curves.....	5-28
Figure 5.2.5.3-b Three Centered Compound Curves Example for a SU-30.....	5-29
Figure 5.2.5.4-a Turning Roadways and Island .....	5-29
Figure 5.2.5.4-b Sample Turning Roadway Design for Passenger Cars and Occasional SU-30's.....	5-31
Figure 5.2.5.4-c Sample Turning Roadway Design for WB-40's .....	5-32
Figure 5.2.5.4-d Turning Roadways .....	5-33
Figure 5.2.5.4-e Turning Roadway Design for Passenger Car and Occasional SU-30.....	5-34
Figure 5.2.5.4-f Turning Roadway Design for SU-30 and Occasional WB-62 .....	5-34
Figure 5.2.5.4-g Turning Roadway Design for WB-62.....	5-35
Figure 5.2.5.5-a Island Sizes without Pedestrians Facilities.....	5-35
Figure 5.2.5.5-b Island Sizes with Pedestrians Facilities.....	5-36
Figure 5.2.5.5-c Triangular Island Offsets .....	5-36
Figure 5.2.5.6-a Turning Movement Offsets.....	5-38
Figure 5.2.6-a Entrance Length Example.....	5-39
Figure 5.2.6-b Recommended Minimum Entrance Lengths.....	5-39
Figure 5.2.6-c Recommended Drive-thru Queue Distances .....	5-40
Figure 5.2.7-a Angle of Driveway.....	5-41
Figure 5.2.8-a Vertical Alignment at an Entrance.....	5-41
Figure 5.2.8-b Entrance Drive Tie-in to Frontage Road.....	5-43
Figure 5.2.9.1-a Right Turn Lane Warrants ( $R < 50'$ ).....	5-45

## TABLE OF CONTENTS

Figure 5.2.9.1-b Right Turn Lane Warrants ( $R > 50'$ ).....	5-46
Figure 5.2.9.2-a Bypass Lane Warrants.....	5-48
Figure 5.2.9.2-b Typical Entrance Diagram with Bypass Lane.....	5-50
Figure 5.2.9.3-a Left-Turn Lane Warrants at Unsignalized Intersections.....	5-53
Figure 5.2.9.3-b Typical Entrance Diagram with Left-Turn Lane.....	5-55
Figure 5.2.9.4-a Directional Median Crossover for WB-40 D.V. – Median Width $>4'$ to $<18'$ .....	5-57
Figure 5.2.9.4-b Directional Median Crossover for WB-62 D.V. – Median Width $>4'$ to $<18'$ .....	5-58
Figure 5.2.9.4-c Directional Median Crossover for WB-40 D.V. – Median Width $>18'$ .....	5-59
Figure 5.2.9.4-d Directional Median Crossover for WB-62 D.V. – Median Width $>18'$ .....	5-60
Figure 5.3.1.3-a Intersection Curb Ramp Detail.....	5-63
Figure 5.3.1.3-b Maximum Difference in Grade for all Curb Ramp Types.....	5-63
Figure 5.3.2.2-a Cross Section – Two Way Shared Use Path.....	5-65
Figure 5.4-a Sight Distance Triangles.....	5-67
Figure 5.5.2-a Subdivision Street Typical Section (With Curb) - Types I and II.....	5-69
Figure 5.5.2-b Subdivision Street Typical Section (With Curb) - Type III.....	5-70
Figure 5.5.2-c Subdivision Street Typical Section (Without Curb).....	5-71
Figure 5.5.2-d Industrial Streets Typical Section (With and Without Curb).....	5-72
Figure 5.5.6-a Lateral Offset Widths.....	5-75
Figure 5.5.6-b Lateral Offsets at Merge Points.....	5-76
Figure 5.5.6-c Lateral Offsets at Entrances.....	5-77
Figure 5.6-a Material Properties.....	5-78
Figure 5.6.1-a Pavement Design Chart for Internal Subdivision Streets.....	5-80
Figure 5.6.2-a Pavement Design Chart for Entrances.....	5-81
Figure 5.6.4-a Pavement Tie-in Detail.....	5-82
Figure 5.6.4-b Lane Widening/Restoration Detail.....	5-82
Figure 5.7.2.5-a Material Based Pipe Cover Requirements (Standard Installation).....	5-86
Figure 5.7.2.5-b Existing Pavement Shallow Pipe Cover Details.....	5-86
Figure 5.7.2.6-a Drainage Easement Requirements.....	5-87
Figure 5.7.2.7-a Subdivision Streets Drainage Criteria.....	5-88
Figure 5.11.1.3-a Street Name Sign Location.....	5-93
Figure 5.13-a Signal Design Flow Chart.....	5-95

---

## **CHAPTER 5    DESIGN ELEMENTS**

---

### **5.1    GEOMETRIC DESIGN OF SUBDIVISION STREETS**

#### **5.1.1    Geometric Design of Subdivision Streets - General**

The design of subdivision streets is required to be in accordance with applicable guidelines and standards, such as those listed in Section P.9.1 of this manual, which include but are not limited to: Manuals, Guidelines and Policies published by the *American Association of State Highway and Transportation Officials* (AASHTO); DelDOT's *Road Design Manual (RDM)*; DelDOT's *Bridge Design Manual*; DelDOT's *Design Guidance Memorandums (DGM)*; DE MUTCD; other **Nationally Accepted Standards (NAS)** and DelDOT's *Development Coordination Manual*. Where conflicts exist, DelDOT's *Development Coordination Manual* shall take precedence for subdivision streets.

In instances where the engineer determines that it is not in the best interest of the traveling public to comply with these standards, the engineer shall provide to DelDOT a written justification and rationale for their decision. DelDOT shall have the final authority on any process modifications, design exceptions, or design deviations.

The street layout of a subdivision has the following elements that must be considered by the developer and engineer:

- A. Horizontal and vertical alignment
- B. Intersection design
- C. Sight distance
- D. Typical sections designed to support the traffic volumes anticipated for each road segment
- E. Connectivity of both vehicular, bicycle and pedestrian traffic along with transit accessibility
- F. Traffic calming
- G. Stormwater management
- H. Drainage

### 5.1.2 Geometric Design of Subdivision Streets - Design Criteria

The design criteria for subdivision streets shall be in accordance with Figure 5.1.2-a.

**Figure 5.1.2-a Design Criteria for Subdivision Streets**

Type of Subdivision Street	Design Speed	Sight Distance*	Maximum Grades**	Minimum Horizontal Radii	Minimum K-Value	
					Sag	Crest
Type I (< 500 ADT)	25 mph	155 feet	10%	150 feet	26	12
Type II (501 – 3000 ADT)	30 mph	200 feet	8%	300 feet	37	19
Type III (> 3000 ADT)	35 mph	250 feet	7%	500 feet	49	29
Industrial Streets	35 mph	250 feet	7%	500 feet	49	29

\* For upgrades and downgrades 3% or greater, refer to the AASHTO Green Book, A Policy on Geometric Design of Highways and Streets ( Table 3-2 of the 2011 Edition), or other NAS for adjusted values. Sufficient right-of-way dedicated to the State of Delaware shall be provided to maintain the required line- of-sight.

\*\* Maximum street grades can be waived on an individual basis subject to DelDOT's engineering judgment with respect to the severity of the topography. Minimum street grades should be 0.5%.

Notes:

1. Vertical curves will be required on streets with an algebraic grade difference greater than one percent (1%).
2. Deviations from these criteria shall only be considered if presented in writing and if it has been proven to the satisfaction of DelDOT that the required criteria cannot be met.

### 5.1.3 Geometric Design of Subdivision Streets - Intersection Design

The intersection design of subdivision streets shall be in accordance with the following:

- A. 90° intersections are preferred. Intersection angles less than 70° are not permitted.
- B. The edge of pavement radii of internal subdivision streets shall meet the requirements of Figure 5.1.3-a. The use of larger radii may be considered if there is a need to accommodate larger vehicles. Any entrance for a new subdivision shall meet or exceed the requirements of Section 5.2.
- C. The profiles of intersecting subdivision streets influence the vertical alignment of an intersection, especially when different types of streets intersect such as Type I and Type II streets. When this occurs, the major street type retains a crown through the intersection as shown in Figure 5.1.3-b. The intersection approach grade in the uphill direction affects the acceleration of motor vehicles from a stopped condition, and therefore can have an impact on vehicular delay at the intersection. The intersection approach grade in the downhill direction affects the stopping sight distance of approaching motor vehicles. The length of vertical curves between the non-intersection grade and the intersection approach grades are governed by the 'K' values listed in Figure 5.1.2-a. See Figure 5.1.3-c for additional design guidance.

**Figure 5.1.3-a Intersection Design Radii**

Intersecting Subdivision Street Types		Corner Radii (@ edge of pavement)
Type I	Type I	15 feet
Type I	Type II	20 feet
Type II	Type II	25 feet
Type II	Type III	25 feet
Type III	Type III	Set to meet design vehicle

**Figure 5.1.3-b Maintaining Major Street Crown through Intersection**

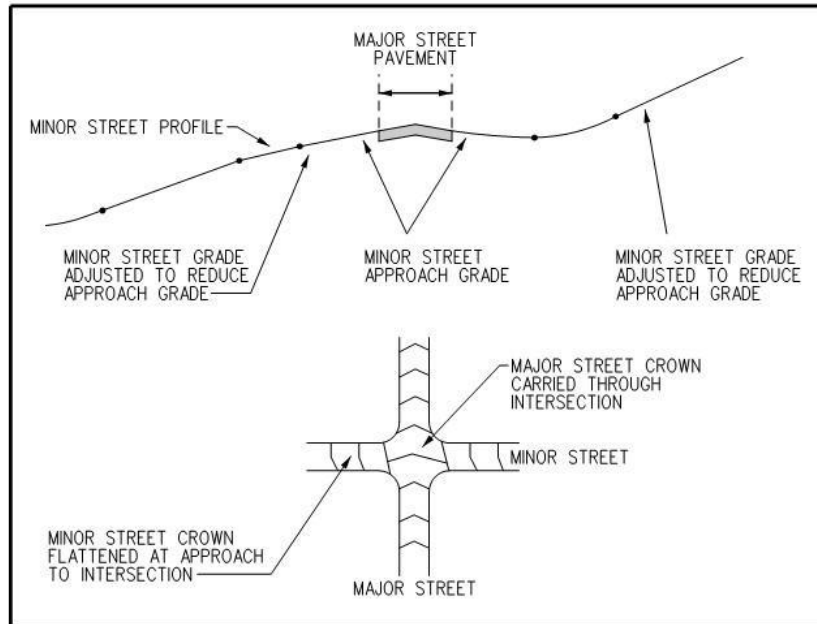
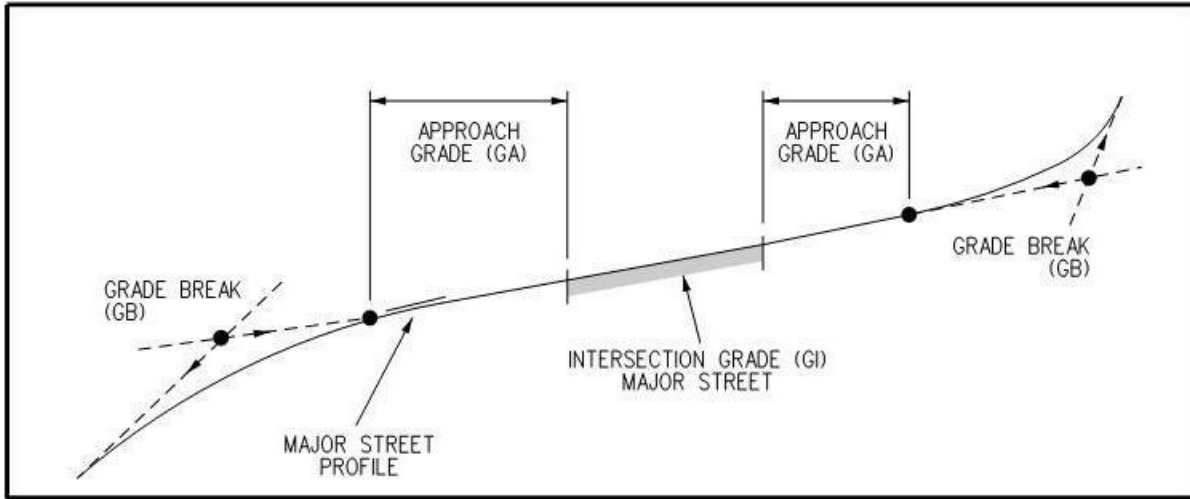


Figure 5.1.3-c Vertical Alignment Guidelines



Subdivision Street Type	Design Speed (mph)	Maximum Intersection Grade (GI, %)	Maximum Grade Break (GB, %)	Minimum Length of Approach Grade (GA, ft)
I	25	5	4	40
II	30	5	3	60
III	35	5	2	60

- D. The distance required to remove the roadway crown of a minor street at an intersection is to be established using a maximum relative longitudinal slope between the profiles of the edge of pavement and centerline. A relative gradient (G) of 0.666 percent between the centerline profile grade and edge of traveled way should be used.

$$G (\%) = 1/RS \times 100$$

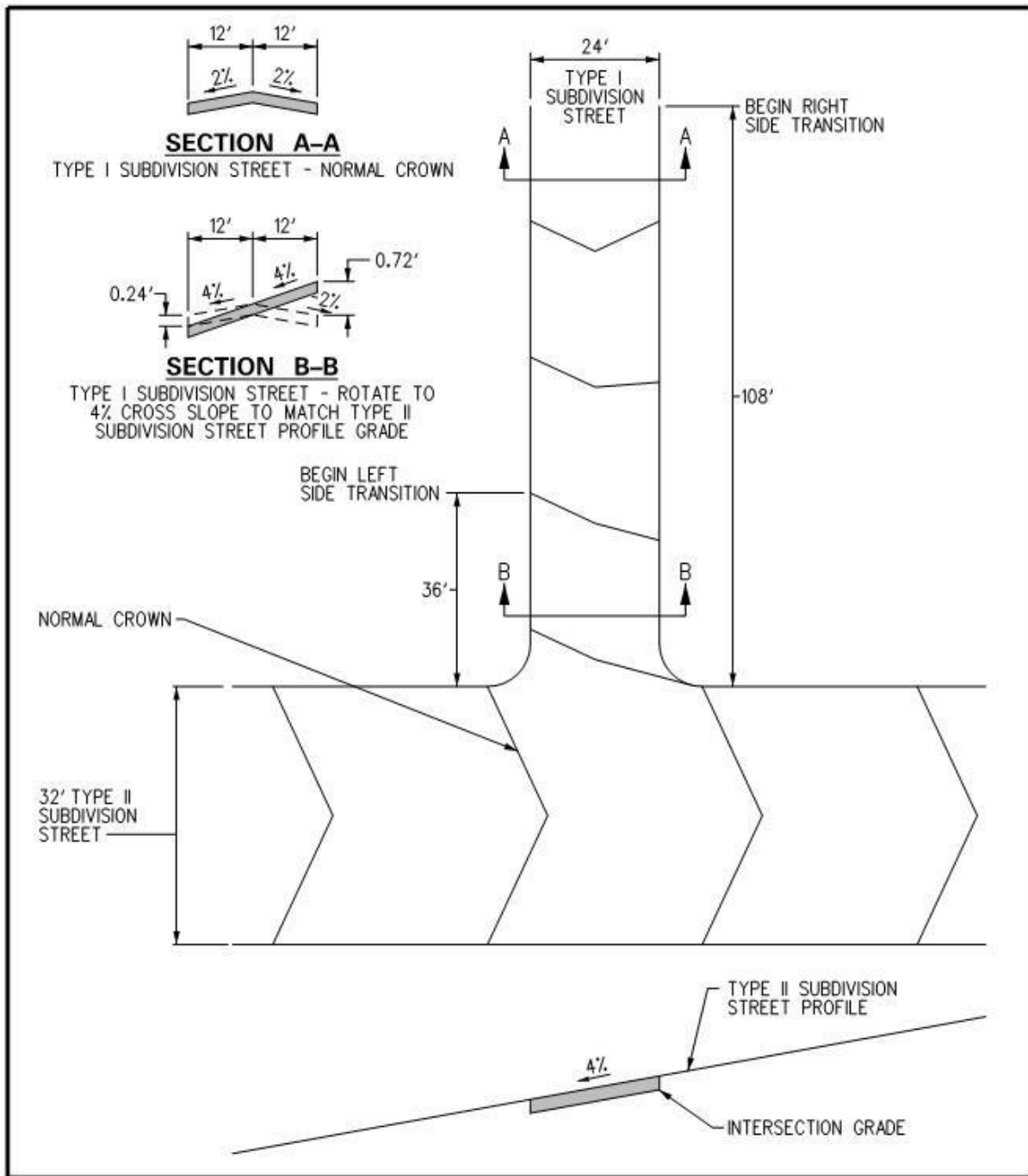
RS = 150 or reciprocal of relative longitudinal slope between the profile grade and outside edge of pavement of a two-lane street

The roadway crown of the major street is to be maintained.

An example as shown in Figure 5.1.3-d is a Type 1 subdivision street intersecting a Type II subdivision street having a 4% grade as shown below. The right outside edge of the Type 1 subdivision street must rotate from a -2% C.S. to a 4% C.S. or 0.72' and the left outside edge of the Type 1 subdivision street must rotate from a -2% C.S. to a -4% C.S. or 0.24'. Dividing 0.72' by G or 0.666% results in a transition length of 108' on the right outside edge of the Type 1 subdivision street. Dividing 0.24' by 0.666% results in a transition length of 36' on the left outside edge of the Type 1 subdivision street.



Figure 5.1.3-d Intersection Cross Slope Transition Example



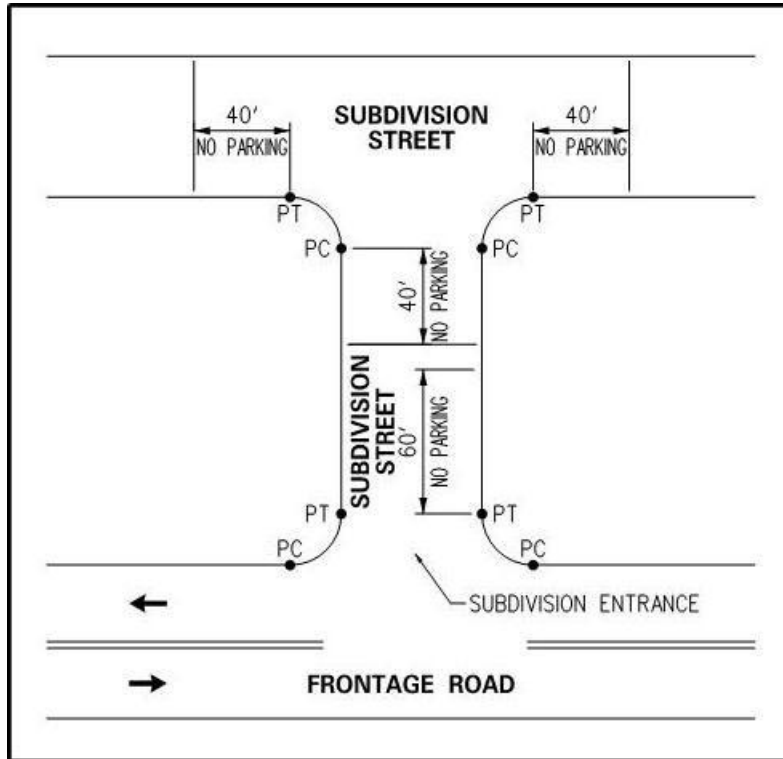
- E. Signing and striping shall be in accordance with the DE MUTCD, latest edition.
- F. Roundabouts may be used for intersection design within subdivisions. The design shall conform to applicable guidelines and standards such as: DeIDOT's Guidelines on Roundabouts, DeIDOT's Design Guidance Memorandum (DGM) 1-26 for Roundabouts or other **NAS**. At a minimum, the roundabouts shall include a center island, truck apron, splitter islands on all approaches, and appropriate pedestrian signs and markings.

### 5.1.4 Geometric Design of Subdivision Streets - Parking Provisions

Parking is not allowed on turnarounds and cul-de-sacs within subdivisions.

No driveways or parking bays shall be located in subdivisions within 40 feet from the edge of the radius return for the connecting street. This distance shall increase to 60 feet at the entrance to the subdivision.

Figure 5.1.4-a Subdivision Street Parking Provisions



In order to restrict parking in areas within a subdivision street that can accommodate overflow on-street parking, the DelDOT Traffic Section must receive a petition signed by 75% of the owners indicating their support for “Stopping, Standing, and Parking Restriction.” DelDOT will determine whether to restrict on-street parking within subdivision streets considering the petition and engineering study performed by DelDOT.

### 5.1.5 Geometric Design of Subdivision Streets - Dead End Streets

#### 5.1.5.1 Permanent Dead End Streets

The use of cul-de-sac and other closed end street design is to be limited to those situations where the developer’s engineer meets the connectivity requirements of Section 3.5 or can justify that full street extensions are not possible based on topography, pre-existing development or environmental constraints.

Cul-de-sacs must be incorporated in the design of all permanent dead end streets except those eligible to be constructed within a reduced right-of-way. The minimum design criteria for cul-de-sacs are:

- A. Design radii shall be in accordance with Figure 5.1.5.1-a.
- B. Graded aggregate base course material for cul-de-sacs is to extend a minimum of two feet beyond the edge of paving when an open drainage design is utilized (no curbs).
- C. The maximum tangent length as measured from the corner radii of the intersecting street to the cul-de-sac radius for a permanent dead end street is 200 feet.

**Figure 5.1.5.1-a Design Radii for Cul-de-Sacs**

Radius*	Cul-de-sacs	Cul-de-sacs with Center Islands
Right-of-Way	50 feet	60 feet
Outside Edge of Pavement	38 feet	46 feet
Center Island	N/A	24 feet

*\* Measured to the face of curb.*

Developers planning streets with reduced right-of-way should select one of the turn-around designs shown in Figure 5.1.5.2-a in lieu of the standard cul-de-sac. Any alternative design must have prior approval of DelDOT.

**5.1.5.2 Temporary Dead End Streets**

Temporary dead end streets shall be constructed to the property line of the development in order to provide for future development of adjacent lands. A temporary turn around must be provided when the length of a temporary dead end street exceeds 200 feet. The additional right-of-way needed to accommodate a temporary turn around can be provided through a temporary easement which must be clearly labeled on the site plan. If the street segment is accepted for State maintenance, DelDOT will maintain the temporary dead end street in accordance with Chapter 6.

If the temporary dead end street shall ultimately provide connectivity to the adjacent property, the following shall apply:

- A. For all projects with planned connectivity, a note stating “Future Connection to Adjoining Property” shall be prominently displayed on the Record Subdivision Plan.
- B. For all projects where the connection stub street is constructed abutting the adjacent property, a sign stating “Street Connection to Future Development” shall be installed by the developer at the end of the stub street prior to the first Certificate of Occupancy being issued. Maintenance of the sign shall be the responsibility of the developer until DelDOT accepts the streets into the State maintenance system.

For projects where the connection is internal, but will not be constructed until future phases, stub streets shall be constructed to extend to the end of the radii at the intersection with the future street. A sign stating “Future Internal Street and Connection to Future Development” and barricade, as shown in DelDOT’s Standard Construction Details, shall be installed by the developer at the end of the stub street.

*DelDOT Development Coordination Manual*

The sign shall be placed immediately after the placement of the base paving course. At DelDOT's discretion, the barricade requirement may be waived. Maintenance of the sign and barricade shall be the responsibility of the developer until DelDOT accepts the streets into the State maintenance system. Upon acceptance of the streets, the development's maintenance association assumes maintenance responsibility of sign. Refer to Figures 5.1.5.2-a and 5.1.5.2-b for stub street sign details.

Figure 5.1.5.2-a Design Alternatives in lieu of Cul-de-Sacs in Reduced Right-of-Way  
(Not to Scale)

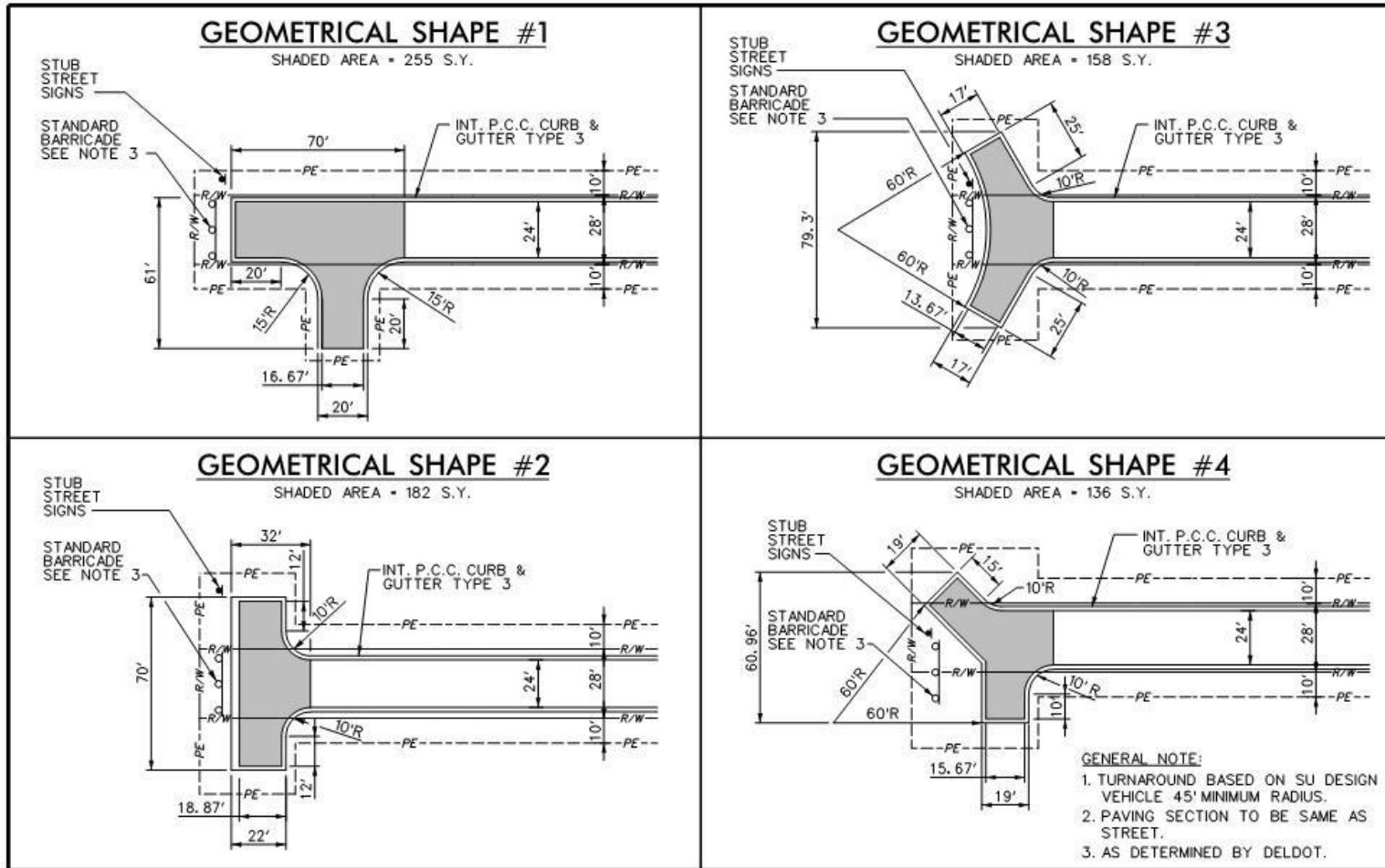
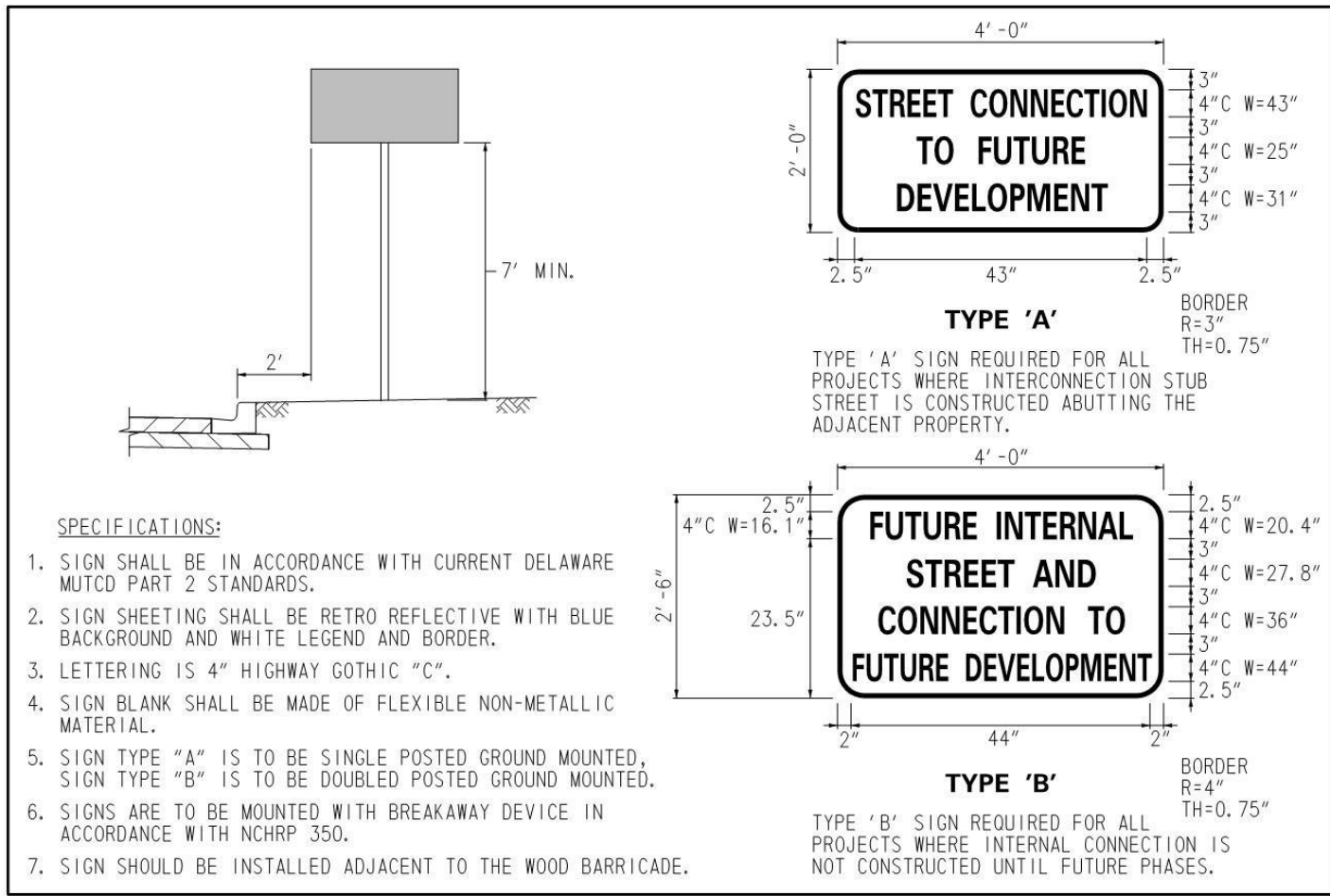


Figure 5.1.5.2-b Stub Street Sign Detail

(Not to Scale)



### **5.1.6 Geometric Design of Subdivision Streets - Traffic Calming**

The DeIDOT *Traffic Calming Design Manual* (TCDM) provides detailed guidance regarding the appropriate use, design, signing and marking of traffic calming measures approved for use in Delaware. Even if the TCDM is not used for subdivision design, site design should be done in a manner so as to reduce the need for speed control devices after subdivision construction.

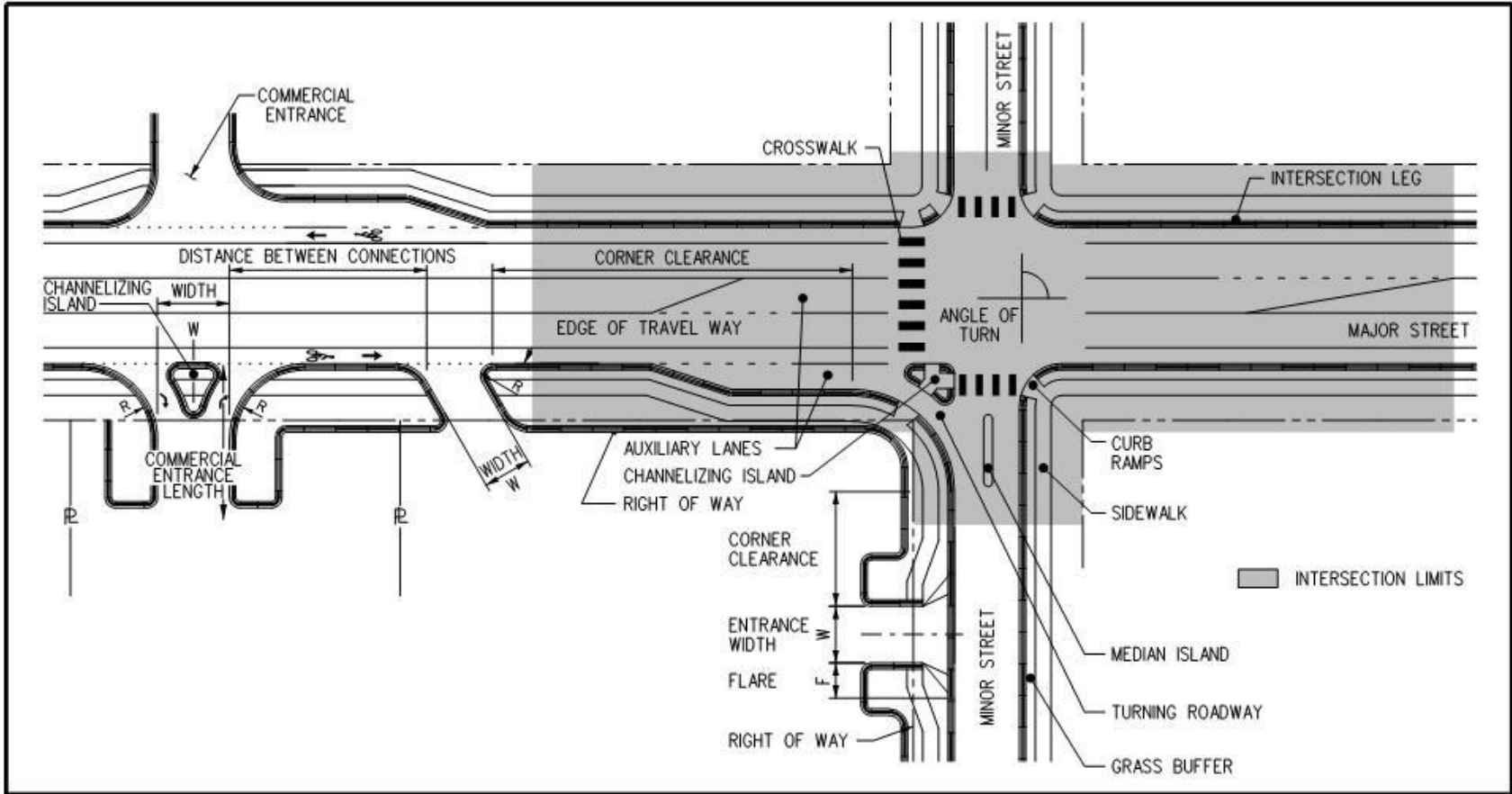
## **5.2 SUBDIVISION AND COMMERCIAL ENTRANCE DESIGN GUIDELINES**

DeIDOT has adopted policies with regard to subdivision and commercial entrances that create public intersections which warrant special consideration with respect to location and design.

- A. Entrance design should consider a range of objectives that include:
  - 1. Maintaining the safe and efficient operations of the intersecting roadway
  - 2. Providing reasonable access to the property
  - 3. Providing sight distance between vehicles and pedestrians as well as efficient travel for sidewalk users
  - 4. Incorporating ADA requirements for pedestrians with disabilities
  - 5. Accommodating bicycle lanes or paths
  - 6. Maintaining or providing public transportation locations
  
- B. In order to achieve the objectives mentioned above, entrances need to be properly designed with respect to:
  - 1. Location, among existing and planned intersections within the vicinity
  - 2. Design vehicle selection
  - 3. Entrance width, number of lanes, and lane configuration
  - 4. Horizontal alignment
  - 5. Vertical alignment
  - 6. Auxiliary lane provisions
  - 7. Channelization
  - 8. Pedestrian, bike, and transit considerations

Detailed guidance on each of the design controls mentioned above are discussed in subsequent sections of this Chapter. Figure 5.2-a illustrates the basic elements and design controls associated with entrance design. Detailed definitions for those elements described are included in the Definitions.

Figure 5.2-a Entrance and Intersection Design Elements

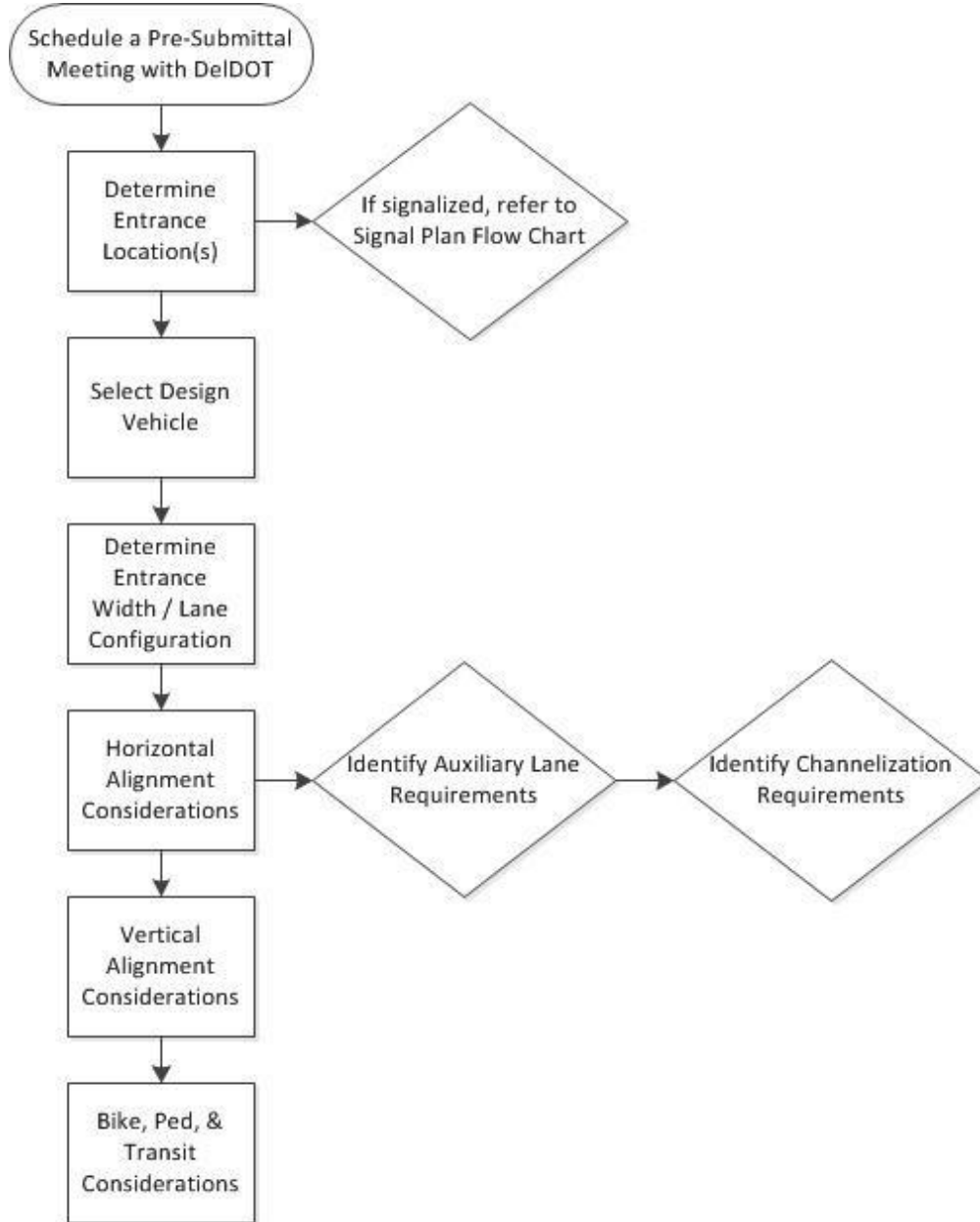




**5.2.1 Subdivision and Commercial Entrance Design Guidelines –Process**

Proper entrance design requires consideration of many design controls in the context of surrounding intersections, entrances, roadways, and their users (e.g. vehicles, pedestrians, bicycles, transit). Figure 5.2.1-a provides an outline for successfully planning and designing a commercial site entrance. It is recommended that the design engineer schedule a Pre-Submittal meeting with DeIDOT staff early in the design process in order to confirm consensus on critical design controls. The design engineer assumes full responsibility for design performed without first confirming design controls with DeIDOT.

*Figure 5.2.1-a Subdivision and Commercial Entrance Plan Decision Flow Chart*



## **5.2.2 Subdivision and Commercial Entrance Design Guidelines – Entrance Location**

As entrances are introduced to an existing roadway, additional vehicle-to-vehicle conflict points are created, which has the direct impact of reducing safety along the roadway. Insufficient spacing between nearby entrances and intersections compound these adverse effects. While no access management program can completely eliminate safety concerns associated with entrances, there are guidelines to selecting an entrance location that can reduce these impacts.

When deciding on the location of a proposed entrance, one of the most important factors is its distance to nearby intersections. According to AASHTO, entrances should ideally be located outside the functional area of an intersection or adjacent driveway. The functional area extends both upstream and downstream from the physical intersection area and includes the longitudinal limits of auxiliary lanes. This allows for the best operations with respect to traffic exiting the site and positioning itself at the intersection approach and reduces the chance that queues from the downstream intersection will block the entrance.

Ideally, spacing between entrances should be provided as equal to the stopping sight distance on the abutting roadway. This allows drivers on the roadway to take notice and be prepared for entering or exiting vehicles at each individual access point. When spacing is shorter than this distance, the driver experiences overlapping attention demands and attention is diverted from other driving tasks.

In cases of urban infill and redevelopment, ideal spacing of entrances cannot always be provided. With that in mind, the following general guidelines should be followed when selecting an entrance location.

- A. When possible, entrances should not be located within the functional area of a nearby intersection or driveway. Entrances close to a major intersection result in motorists negotiating conflicts close to an area designed to manage large volumes of traffic, which may lead to unsafe and bad operational conditions as shown in Figure 5.2.2-a.
- B. When possible, provide spacing between successive entrances equal to the stopping distance of the adjacent roadway.
- C. When a parcel of land is being developed that fronts on a major and a minor roadway, the access to this parcel should be from the minor roadway and not the major roadway. Exceptions may be considered by the Subdivision Engineer.
- D. Where feasible, an entrance should be located directly across from an entrance on the opposite side of the roadway. If this is not possible, entrances should be located a sufficient distance from nearby entrances to avoid the “jog maneuvers” shown in Figure 5.2.2-b. Desirable offset distances are given in Figure 5.2.2-c.
- E. In the case of corner lot development and redevelopment, entrances should be placed as far away from the adjacent intersection as the property limits allow.
- F. The minimum distance between the entrance radius and the property line shall be 5 feet.

Figure 5.2.2-a Corner Clearance

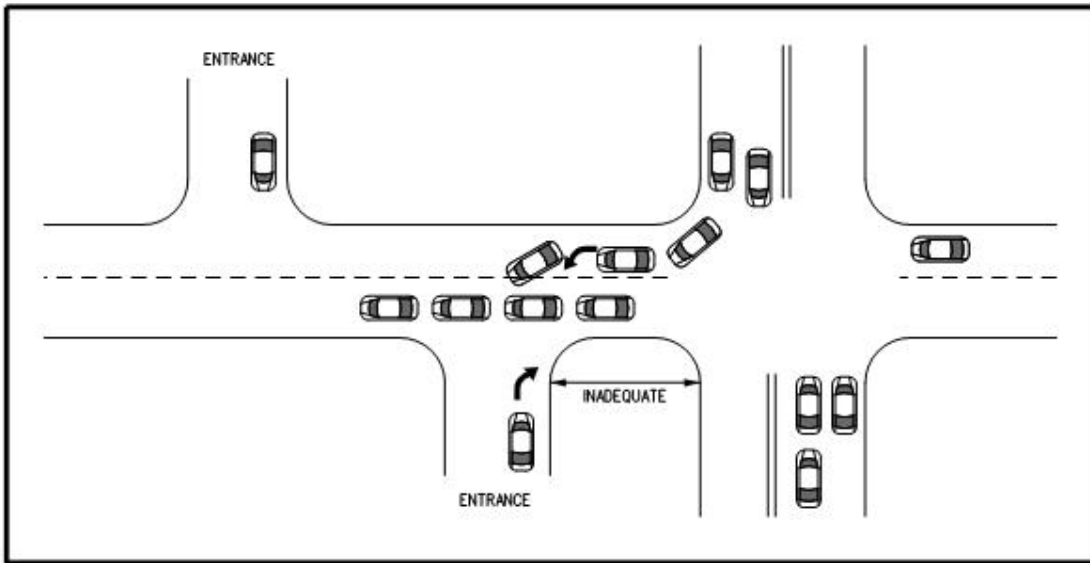
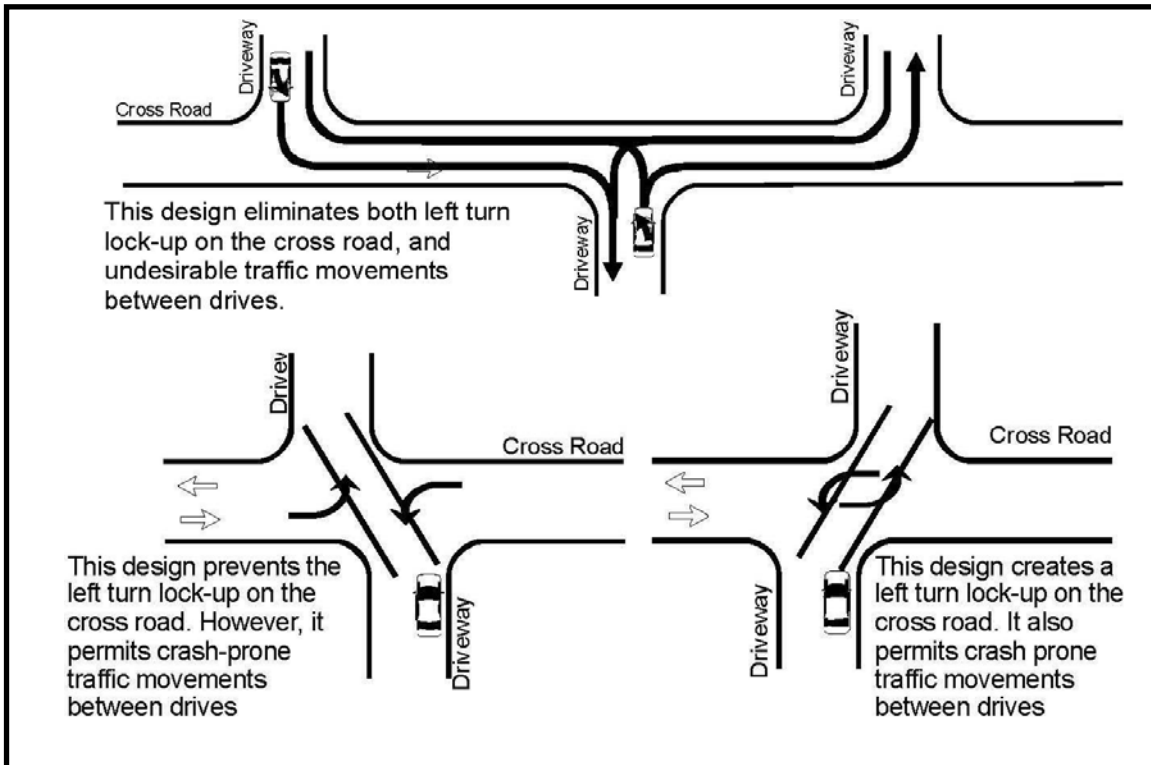


Figure 5.2.2-b Avoiding Entrance Jog Maneuvers



**Figure 5.2.2-c Desirable Offsets on Undivided Highways**

Posted Speed (mph)	Desirable Offset Distance Between Access Points on Opposite Sides of the Roadway (feet)
25	255
30	325
35	425
40	525
45	630
50	750

(Source: Michigan Department of Transportation *Traffic and Safety Note 608A*)

The design elements required for a specific entrance shall be constructed within the right-of-way or easements of the roadway. The engineer is responsible for verifying the right-of-way width and that the required improvements can be constructed. If the right-of-way cannot accommodate the required entrance improvements, the developer can acquire the necessary right-of-way, restrict movements, or reduce the traffic generated from the site to eliminate the need for the improvement.

### **5.2.3 Subdivision and Commercial Entrance Design Guidelines – Design Vehicle**

Proper entrance design with respect to safety, operations, and sustainability is heavily dependent upon selecting the appropriate design vehicle. The functional requirements associated with the entrance to a residential subdivision will be much different than those associated with the entrance of an industrial facility due to the types of vehicles that they will serve. The design vehicle has a major role in determining entrance/lane width and turning radius design. In general, Figure 5.2.3-a should be used for proper design vehicle selection based on the proposed development use. It is incumbent upon the design engineer to confirm consensus of the design vehicle with DelDOT before proceeding with design. The design engineer assumes full responsibility for designing an entrance or intersection without first confirming the selection with DelDOT.

**Figure 5.2.3-a Design Vehicle Selection**

<b>Proposed Development Use</b>	<b>Design Vehicle*</b>
Residential Subdivision	SU-30, WB-40
Bank	SU-30
Gas Station	WB-40, or WB-62
Big Box Store (e.g. Walmart, Lowes, Best Buy)	WB-67
Restaurant (e.g. Applebee's, Chili's, Ruby Tuesday)	WB-62
Fast Food	WB-40, or WB-62
Mid-size Retail/Grocery (e.g. Dollar Store, Giant, Safeway)	WB-62
Small Retail	SU-30, WB-40
Pharmacy	WB-62
Car Wash	SU-30
School	SU-30, WB-62**
Intersections of State Maintained Roadways	WB-62

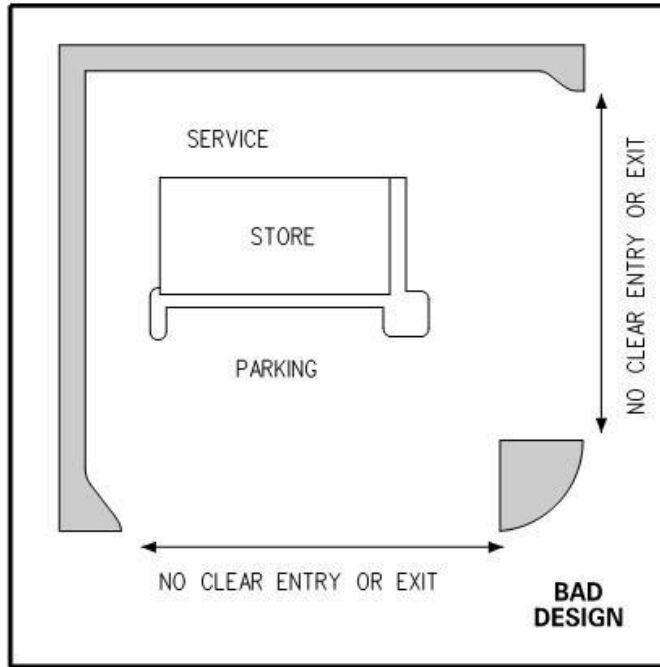
\*Refer to Table 2-44 of AASHTO's *A Policy on Geometric Design of Highways and Streets* (Green Book), 7<sup>th</sup> Edition, for additional information about design vehicle dimensions.

\*\* Encroachment into the opposing lane of the entrance drive may be permitted but not on curb or islands. Refer to Section 5.2.5 for additional guidance.

#### **5.2.4 Subdivision and Commercial Entrance Design Guidelines – Entrance Width**

The entrance width refers to the driveway opening for both ingress and egress lanes. Proper entrance widths are dependent on the number of lanes needed to adequately serve the volume of entrance and exit movements with lanes wide enough so that movements do not encroach upon each other. Entrances should be narrow enough to provide clear points of ingress and egress with appropriate pavement and lane markings to separate movements and travel direction. Figure 5.2.4-a shows an example of poorly designed entrance widths.

**Figure 5.2.4-a Poorly Designed Entrance Widths**



(Source: Michigan Department of Transportation *Access Management Guidebook*)

In general, entrance pavement widths should be provided as shown in Figure 5.2.4-b.

**Figure 5.2.4-b Entrance Pavement Widths**

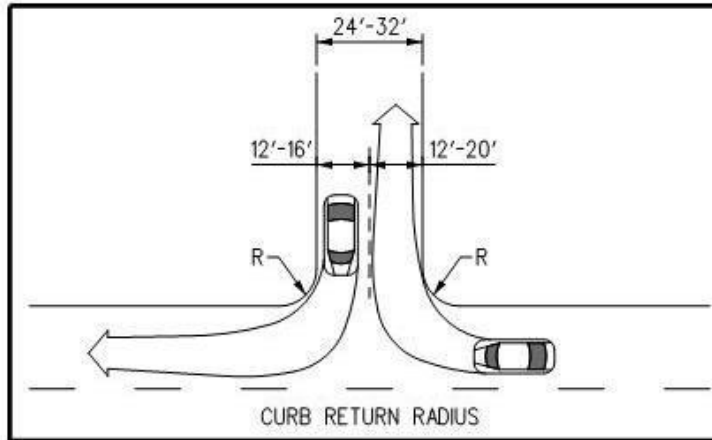
Entrance Type	Pavement Width
Subdivision Type I, II, and III Streets (One-way)	16 feet 18 feet (without curb and gutter)
Subdivision Type I Street (Two-way)	24 feet
Subdivision Type II and III Streets (Two-way)	32 feet
Industrial Street (Two-way)	32 feet
Commercial Access (One-way)	18 feet
Commercial Access (Two-way)	24 – 32 feet

Notes:

1. Entrance widths are also closely related to choice of design vehicle and corner radii design. The widths shown above are given as general guidelines but are not meant as a substitute for design vehicle and corner radii design considerations.
2. Entrance widths may be driven by the need to provide multiple lanes of ingress and egress based on capacity needs of the proposed development in which case the widths shown above would be superseded.

It is acceptable for the entering and exit lanes to be of unequal width in order to accommodate the required turning paths of the design vehicle in combination with corner radii design, as shown in Figure 5.2.4-c.

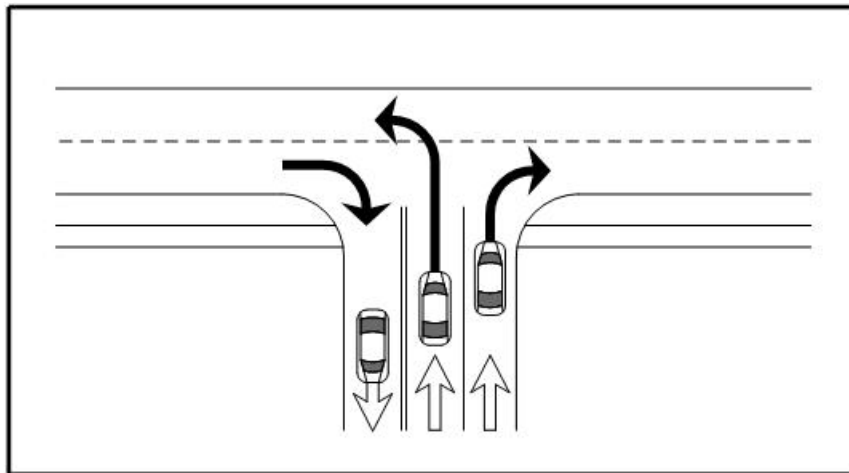
**Figure 5.2.4-c Commercial Entrance Lane Width Example**



(Adopted from Florida Department of Transportation *Driveway Information Guide*)

When determined by a TOA or TIS, separate left and right-turn lanes may be required exiting the entrance of a commercial or large subdivision development. This may also be suggested by the engineer based on site needs. In some cases, only a small number of left-turn vehicles will cause a significant delay to right turning vehicles at a single exit lane. In this case, the additional exit lane will greatly improve operations of an entrance with high entrance volumes.

**Figure 5.2.4-d Separate Left and Right-Turn Exiting Lanes**



### 5.2.5 Subdivision and Commercial Entrance Design Guidelines – Intersection Corner Radii

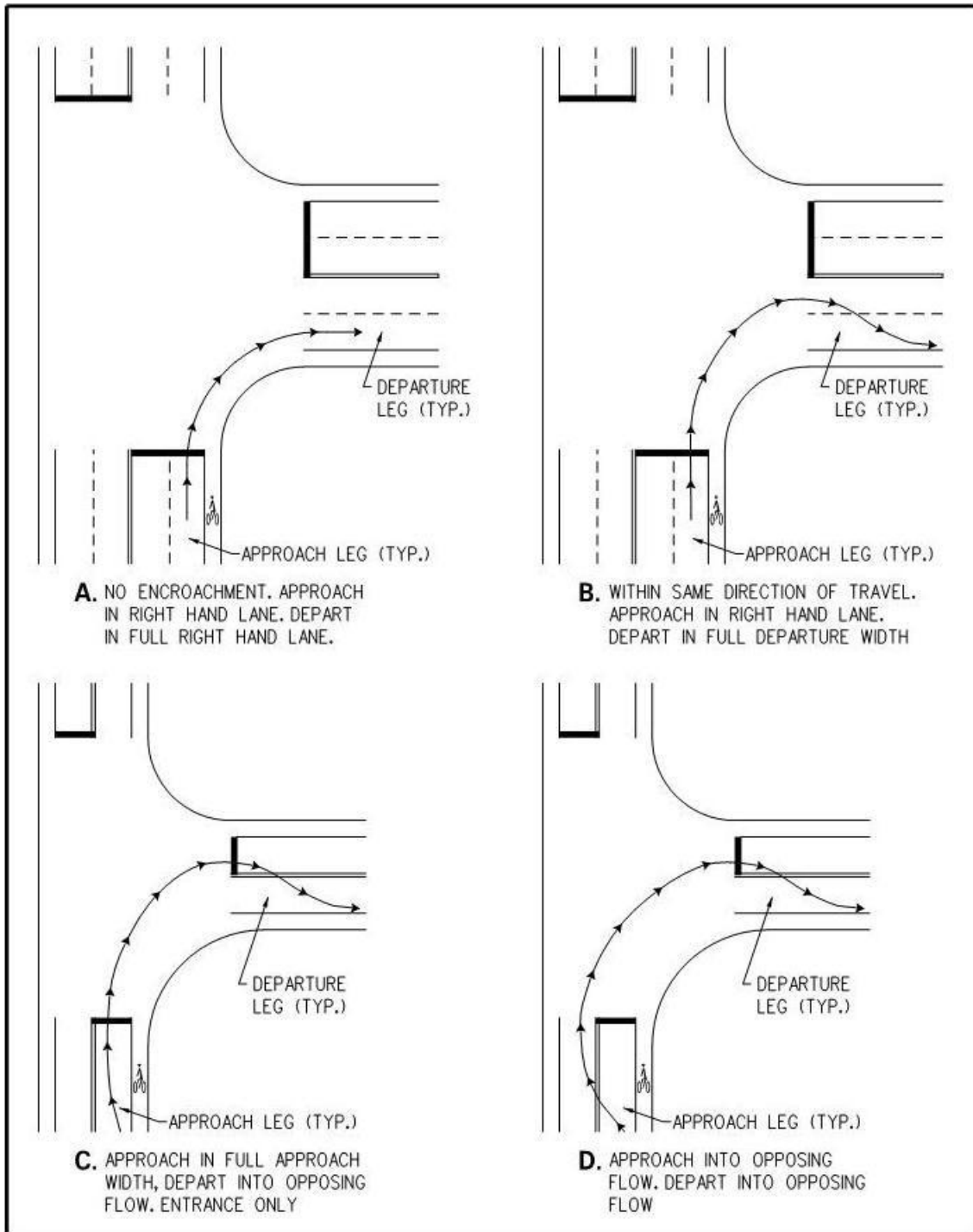
The radii of an intersection’s corners or the curves connecting the edges of pavement of the intersecting streets are defined by either the curb (face or where bituminous concrete/asphalt pavement and edge of gutter meet), or by the edge of pavement where there is no curb. The intersection’s corner radii are key factors in the multimodal performance of the intersection. The corner radius affects the pedestrian crossing distance, the speed and travel path of turning vehicles, and the appearance of the intersection.

Excessively large pavement corner radii result in significant drawbacks in the operation of the street since pedestrian crossing distance increases with pavement corner radius. Further, the speed of turning motor vehicles making right turns is higher at corners with larger pavement corner radii. The compounded impact of these two measures—longer exposure of pedestrians to higher-speed turning vehicles—yields a significant deterioration in safety and quality of service to both pedestrians and bicyclists.

The underlying design control in establishing pavement corner radii is the need to have the design vehicle turn within the permitted degrees of encroachment into adjacent or opposing lanes. Figure 5.2.5-a illustrates degrees of lane encroachment often considered acceptable based on the intersecting roadway types. These degrees of lane encroachment vary significantly according to roadway type, and balance the operational impacts to turning vehicles against the safety of all other users of the street. Although Figure 5.2.5-a provides a starting point for planning and design, the designer must confirm the acceptable degree of lane encroachment during the project development process. It is acceptable for a design vehicle turning from a right turn lane to encroach onto the adjacent bike lane on the approach leg. Lane encroachment in full departure width (not full approach width) as shown in Condition B may be permitted at signalized intersections where a gap is provided allowing the design vehicle turning onto a multi-lane roadway to utilize both travel lanes to make a right turn. Condition C may be acceptable for right turns into an entrance if design vehicle movements are expected during off-peak times. In nearly all cases, Condition D, in which the turning vehicle encroaches into opposing flow, should be avoided. Encroachment by the design vehicle on curbed channelized islands, outer curb line or beyond the edge of pavement (when no curb is present) is not permitted.

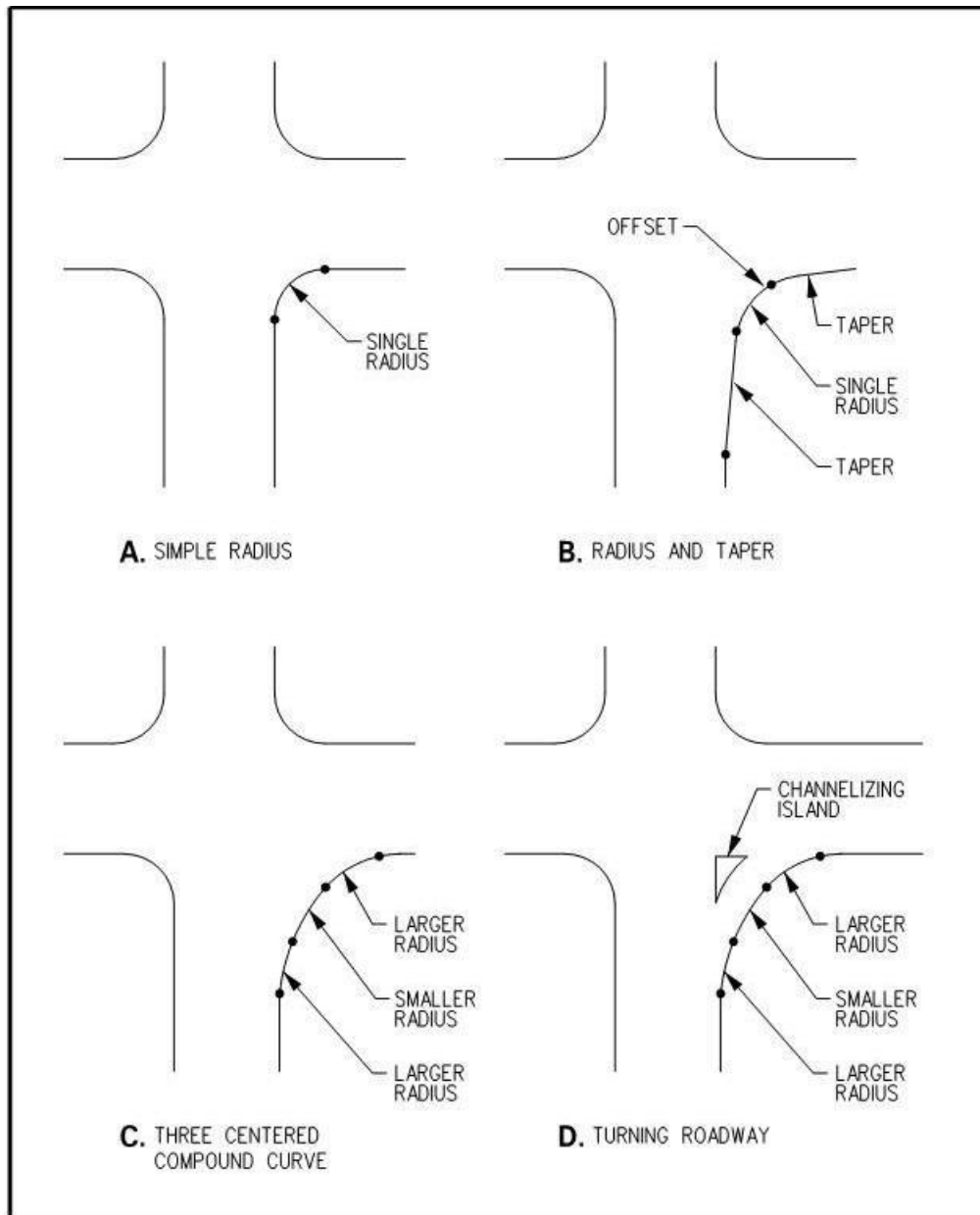


Figure 5.2.5-a Typical Lane Encroachment by Design Vehicle



At the great majority of all intersections, whether curbed or otherwise, the pavement corner design is dictated by the right-turn movement. Left turns are seldom a critical factor in corner design, except at intersections of one-way streets, in which case their corner design is similar to that for right turns at intersections of two-way streets. The method for pavement corner design can vary as illustrated in Figure 5.2.5-b and described below.

Figure 5.2.5-b Methods for Pavement Corner Design



### 5.2.5.1 Simple Curve Radius

A simple curb radius may be used for right turns on roadways at unchannelized intersections for passenger, single unit and small semitrailer design vehicles.

In many situations, the “effective” pavement width on approach and departure legs is greater than an 11 or 12 foot wide travel lane. This is the pavement width usable, by the design motor vehicle, under the permitted degree of lane encroachment. At a minimum, effective pavement width is always the right-hand lane and therefore usually at least 11-12 feet, on both the approach and departure legs. Where a shoulder is present, the shoulder (typically 5 to 8 feet) is added to the effective width on those legs (approach, departure or both), the effective width may increase to between 16 to 20 feet. In addition, the effective width may include

encroachment into adjacent lanes of traffic. An example of this is a combination vehicle using an inside travel lane to make a right turn at a signalized intersection. Figure 5.2.5.1-a shows Conditions A, B and C where the effective width may be utilized to design an intersection corner. An example using Condition B in the figure to determine the curve radius is a SU-30 vehicle turning right at a 90 degree intersection from a local road having an 11 foot travel lane and a 5 foot shoulder onto a collector road having a 12 foot travel lane and an 8 foot shoulder. Therefore, the effective approach leg width is 16 feet and the effective departure leg width is 20 feet. Figure 5.2.5.1-b provides design values for various widths of approach and departure legs at unchannelized intersections.

For larger angles of turns and/or large design vehicles, simple curve radius with taper combinations or three centered compound curves should be considered.

Figure 5.2.5.1-a Effective Pavement Width Examples

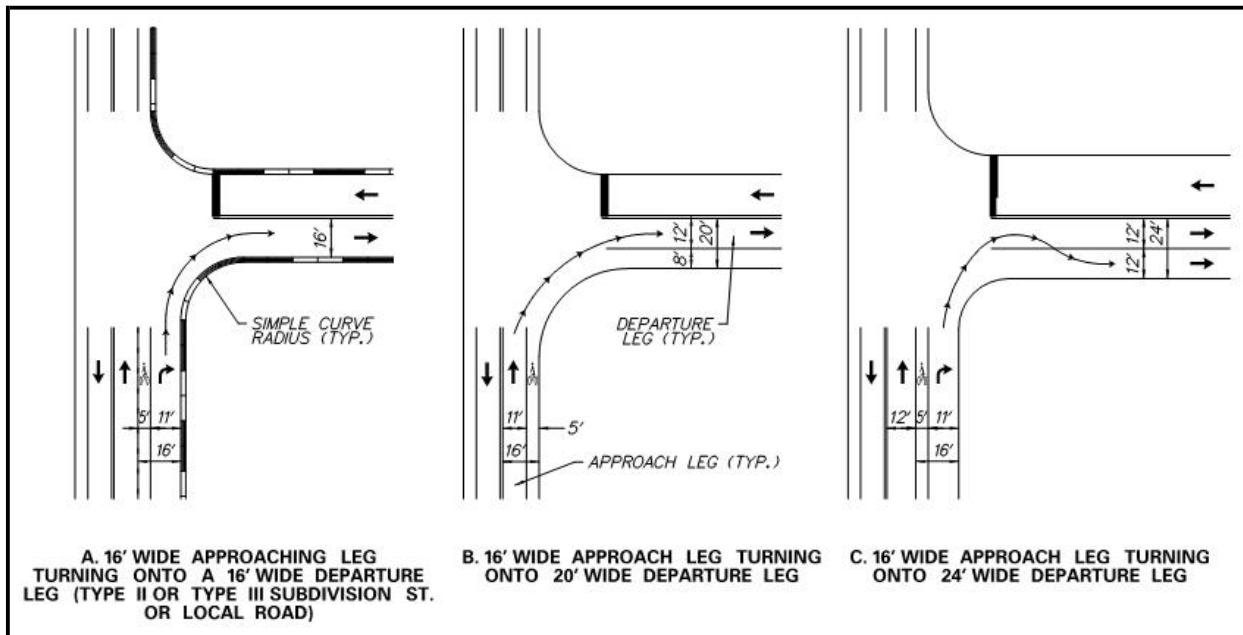


Figure 5.2.5.1-b Simple Curve Radius with Effective Widths

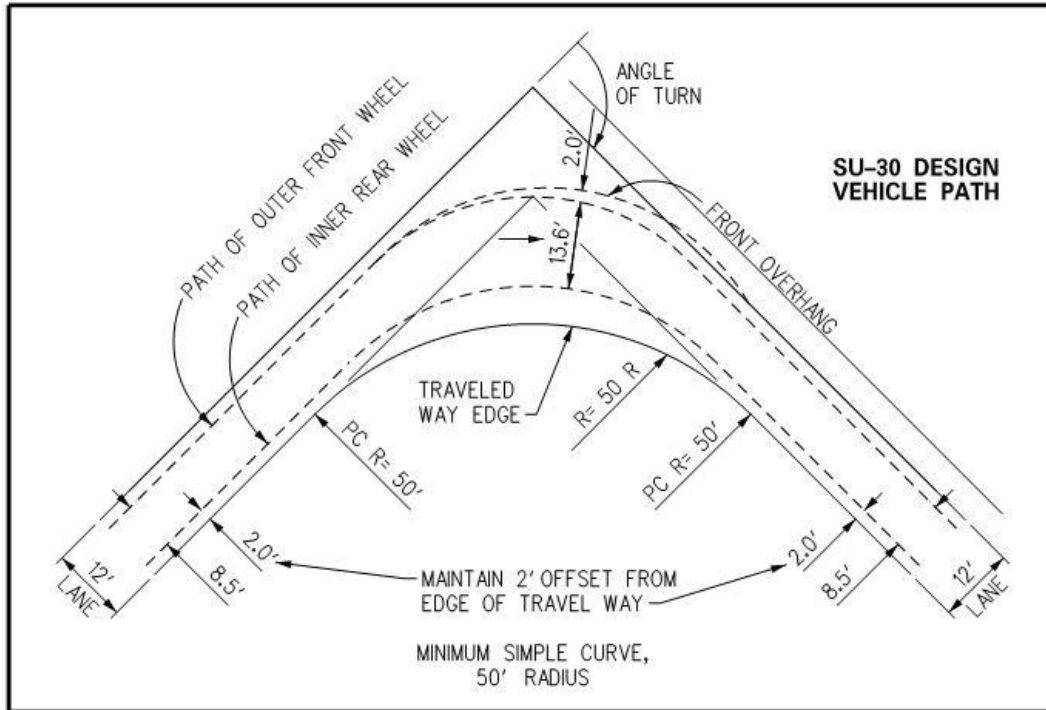
Angle of Turn (Degrees)	Effective Width on Approach Leg (ft)	Effective Width on Departure Leg (ft)									
		Passenger Car (P)			Single Unit Truck (SU-30)			Tractor Trailer (WB-40)			
		12	16	20	12	16	20	12	16	20	24
75	12	35	20	15	55	50	35	100	60	40	35
	16	20	15	15	55	45	25	80	60	35	20
	20	20	15	15	50	35	15	75	50	20	15
90	12	30	20	15	50	40	30	80	60	35	30
	16	20	15	15	50	35	20	75	55	35	25
	20	15	15	15	45	30	15	65	50	25	15
105	12	20	20	15	50	40	30	65	50	35	30
	16	20	15	15	45	35	25	60	50	30	25
	20	15	15	15	40	25	15	55	45	25	20
120	12	20	15	15	45	40	30	60	50	35	30
	16	15	15	15	45	30	25	55	45	30	25
	20	15	15	15	40	25	20	55	40	25	20
150	12	20	15	15	40	30	30	45	40	30	30
	16	15	15	15	40	30	25	45	40	30	25
	20	15	15	15	35	25	25	40	35	25	20

Minimum 15 ft. radius used.

Source: Adapted from A Policy on Geometric Design of Highways and Streets, AASHTO Green Book, 2011, Chapter 9, Intersections

Based on values provided in Figure 5.2.5.1-b, Figure 5.2.5.1-c illustrates the components of a simple curve radius for a SU-30 design vehicle at an unchannelized intersection.

Figure 5.2.5.1-c Simple Curve Radius Example for a SU-30



### 5.2.5.2 Simple Curve Radius with Taper

The combination of a simple radius flanked by tapers can often fit the pavement edge more closely to the design vehicle than a simple radius (with no tapers). This closer fit can be important for large design vehicles where effective pavement width is small (due either to narrow pavement or need to avoid any lane encroachment), or where turning speeds greater than minimum are desired. Figure 5.2.5.2-a summarizes design elements for curve/taper combinations at unchannelized intersections that permit various design motor vehicles to turn, without any lane encroachment, from a single approach lane into a single departure lane. Values provided are for design vehicles turning from a 12 foot wide approach leg onto a 12 wide foot departure leg. If the effective width of the approach leg and/or departure leg is greater than 12 feet, then the offset or taper length ratio may be reduced to optimize the corner design. Refer to DelDOT's *Intersection Corner Radii Examples* which are available online at <http://devcoord.deldot.gov> > Guidance for additional guidance on how to design a corner with a simple curve and taper and examples.

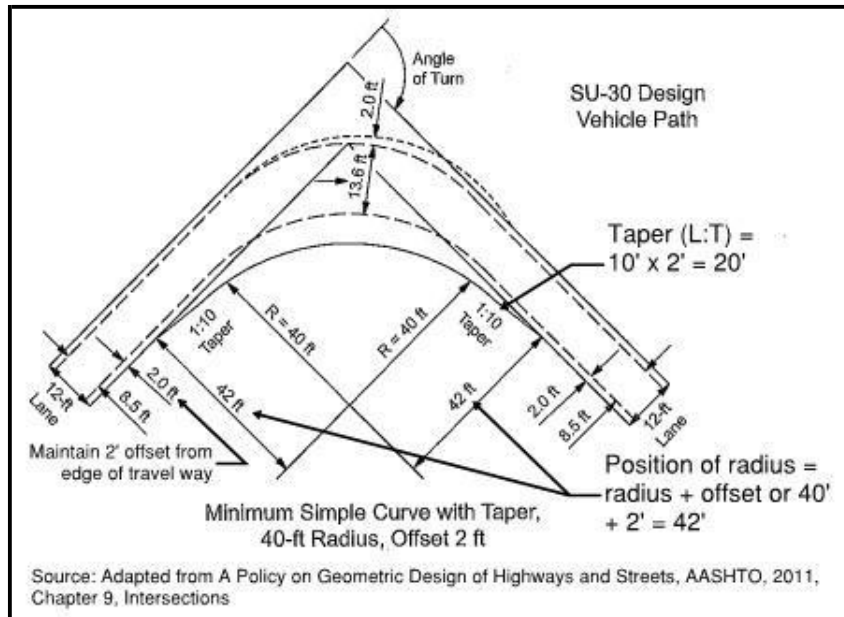
Based on values provided in Figure 5.2.5.2-a, Figure 5.2.5.2-b illustrates the components of a simple curve radius with taper corner design for an SU-30 design vehicle at an unchannelized intersection.

Figure 5.2.5.2-a Simple Curve Radius and Taper

Angle of Turn (Degrees)	Design Vehicle	Simple Curve Radius with Taper		
		Radius (ft)	Offset (ft)	Taper Length (L:T)
75	P	25	2	10:1
	SU-30	45	2	10:1
	WB-40	60	2	15:1
	WB-62	145	4	20:1
90	P	20	2.5	10:1
	SU-30	40	2	10:1
	WB-40	45	4	10:1
	WB-62	120	4.5	30:1
105	P	20	2.5	10:1
	SU-30	35	3	10:1
	WB-40	40	4	10:1
	WB-62	115	3	15:1
120	P	20	2	10:1
	SU-30	30	3	10:1
	WB-40	35	6	8:1
	WB-62	100	5	15:1
150	P	18	2	10:1
	SU-30	30	4	10:1
	WB-40	60	6	8:1
	WB-62	60	10	10:1

Source: Adapted from A Policy on Geometric Design of Highways and Streets, AASHTO, 2011, Chapter 9, Intersections

Figure 5.2.5.2-b Simple Curve Radius and Taper Example for a SU-30



### 5.2.5.3 Three Centered Compound Curves

Figure 5.2.5.3-a shows the minimum edge of traveled way design values for various uses using three centered compound curves at an unchanneled intersection, without any lane encroachment, from a single approach lane into a single departure lane. Values provided are for design vehicles turning from a 12 foot wide approach leg onto a 12 wide foot departure leg. If the effective width of the approach leg and/or departure leg is greater than 12 feet, than the offset may be reduced or the radii and taper for a smaller design vehicle may be used to optimize the corner design. Refer to DelDOT's *Intersection Corner Radii Examples* which are available online at <http://devcoord.deldot.gov> > Guidance for additional guidance on how to design a corner with a three centered compound curve and examples.

**Figure 5.2.5.3-a Three Centered Compound Curves**

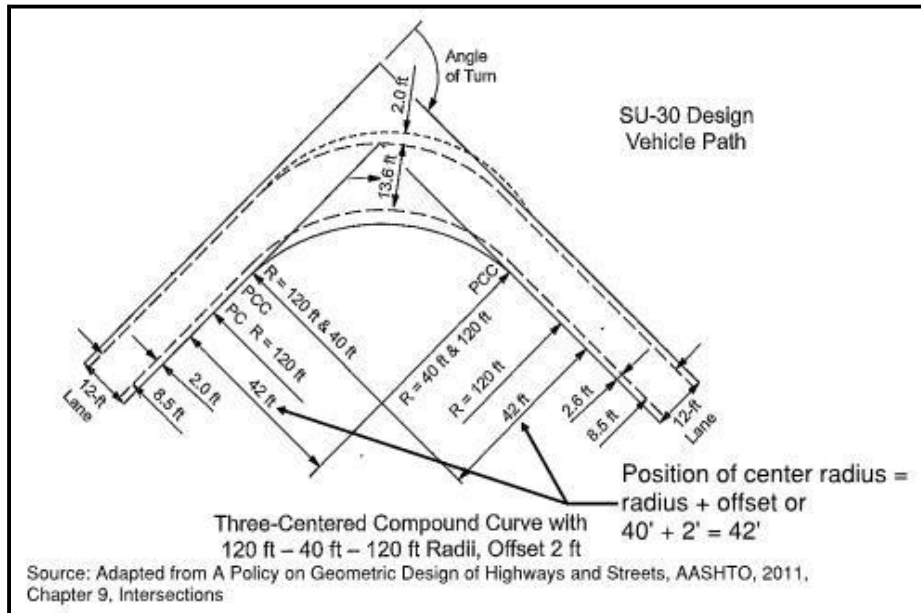
<b>Angle of Turn (Degrees)</b>	<b>Design Vehicle</b>	<b>Radius (R1-R2-R1, ft)</b>	<b>Offset (ft)</b>
75	P	100-25-100	2
	SU-30	120-45-120	2
	WB-40	120-45-120	5
	WB-62	440-75-440	15
90	P	100-20-100	2.5
	SU-30	120-40-120	2
	WB-40	120-40-120	5
	WB-62	400-70-400	10
105	P	100-20-100	2.5
	SU-30	100-35-100	3
	WB-40	100-35-100	5
	WB-62	520-50-520	15
120	P	100-20-100	2
	SU-30	100-30-100	3
	WB-40	120-30-120	6
	WB-62	520-70-520	10
150	P	75-20-75	2
	SU-30	100-30-100	4
	WB-40	100-30-100	6
	WB-62	480-55-480	15

Source: Adapted from A Policy on Geometric Design of Highways and Streets, AASHTO, 2011, Chapter 9, Intersections

Based on design values provided in Figure 5.2.5.3-a, Figure 5.2.5.3-b illustrates the components of a three-centered compound curve corner for a SU-30 design vehicle at an unchannelized intersection.



Figure 5.2.5.3-b Three Centered Compound Curves Example for a SU-30

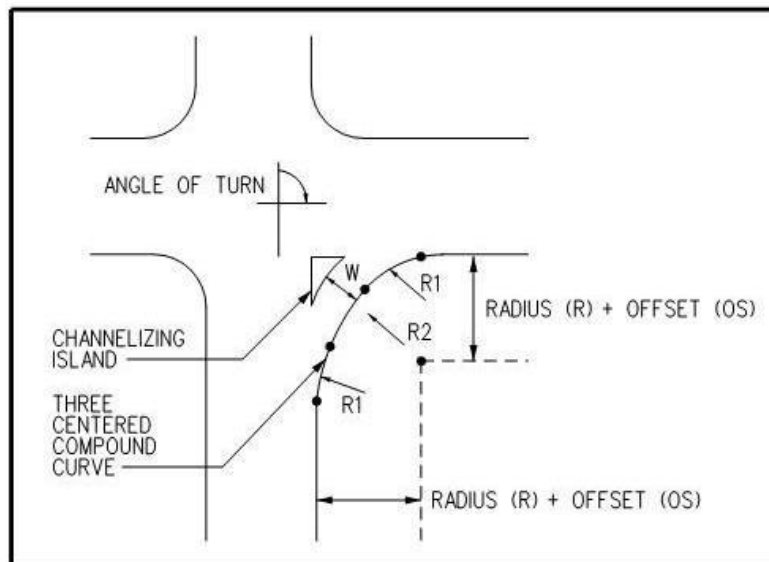


#### 5.2.5.4 Turning Roadways

A separate right-turn roadway, usually delineated by channelization islands and auxiliary lanes, may be appropriate where right-turn volumes are large, where lane encroachment by any motor vehicle type is unacceptable, where higher speed turns are desired, or where angle of turn is well above 90 degrees.

Three centered compound curves may be used on turning roadway for passenger vehicles and should be considered where SU and semitrailer combinations will be turning as shown in Figure 5.2.5.4-a.

Figure 5.2.5.4-a Turning Roadways and Island



[Figure 7-6 \*Design Widths for Turning Roadways\*](#) of DelDOT's *Road Design Manual* provides suggested simple curve radii and lane widths combinations for turning roadways based on several types of smaller design vehicle. Figure 5.2.5.4-b shows a sample turning roadway design using simple curve radii for passenger cars and occasional SU's for a right-in and right-out entrance. Figure 5.2.5.4-c shows a sample turning roadway design for bus and WB-40 design vehicles for a right-in and right-out entrance using simple curve radii. The "effective" pavement width on approach and departure legs may vary the turning roadway width and island size. In all cases, the channelizing island should be checked to verify that it meets the minimum size requirements.





Appropriate design values for turning roadways using three centered compound curves turning from a 12 foot wide approach leg onto a 12 foot wide departure leg are provided in Figure 5.2.5.4-d. When the effective width of the approach leg and/or departure leg are wider than 12 feet, then it may be possible to use smaller curve radii and offset to design the turning roadway. The turning roadway lane widths may be reduced with pavement markings to channelize passenger cars and discourage the usage of the wider turning roadway as two turning lanes. Refer to DelDOT’s *Intersection Corner Radii Examples* which are available online at <http://devcoord.deldot.gov> > Guidance for additional guidance on how to design a turning roadway and examples.

**Figure 5.2.5.4-d Turning Roadways**

Angle of Turn (Degrees)	Design Classification	Three Centered Compound Curve		Width of Lane (ft)
		Radii (R1-R2-R1, ft)	Offset (ft)	
75	A	150-75-150	3.5	14
	B	150-75-150	5	18
	C	220-135-220	5	22
90	A	150-50-150	3	14
	B	150-50-150	11	21
	C	200-70-200	11	25
105	A	120-40-120	2	15
	B	150-35-150	11.5	29
	C	180-60-180	9.5	32
120	A	100-30-100	2.5	16
	B	150-30-150	10.5	33
	C	140-55-140	7	45
150	A	100-30-100	2.5	16
	B	150-30-150	9	42
	C	160-40-160	6	53

*Design Classification:*

*A – Primarily passenger vehicles; permits occasional design single-unit trucks to turn with restricted clearances.*

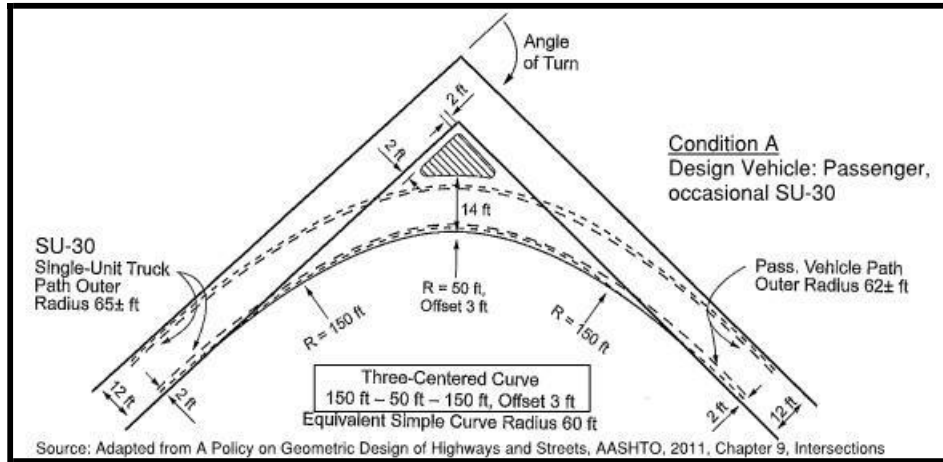
*B – Provides adequately for the SU-30 and SU-40 design vehicles; permits occasional WB-62 design vehicles to turn with slight encroachment on adjacent traffic lanes.*

*C – Provides fully for the WB-62 design vehicle.*

*Verify island size meets minimum preferred size of 100 ft<sup>2</sup> for curbed islands or 175 ft<sup>2</sup> for islands with curb ramps, pedestrian refuge and pedestrian signal poles. Refer to Figures 5.2.5.5-a and 5.2.5.5-b.*

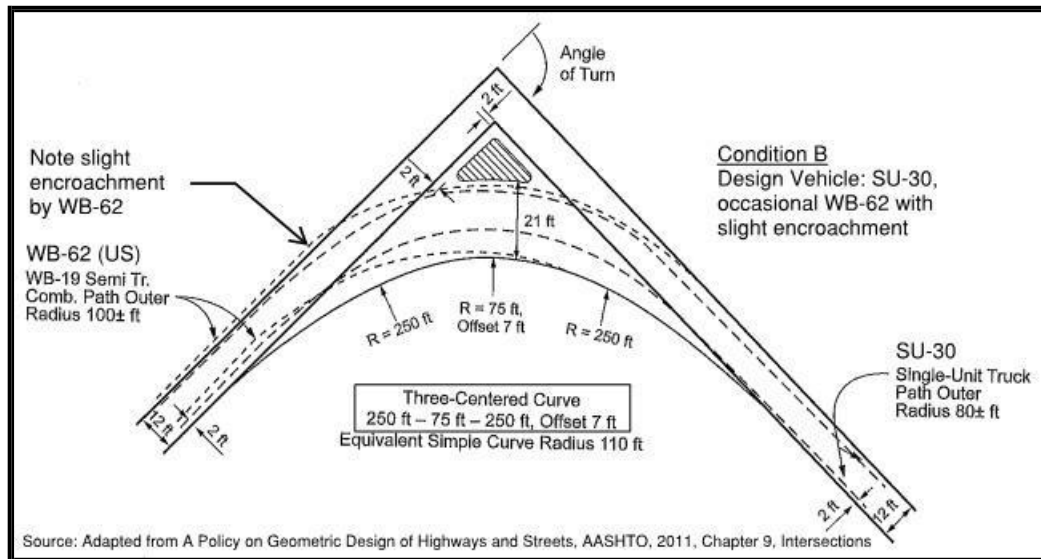
The next three figures show examples of minimum turning roadway designs for 90-degree right turn based on the design vehicle and its frequency of use. Figure 5.2.5.4-e shows a minimum turning roadway using a three-centered curve with radii of 150, 50, and 150 ft with the middle curve being offset 3 ft from the tangent edged extended and a 14 ft lane width. This design not only permits passenger vehicles to turn at a speed of about 15 mph but also enables single-unit truck designs vehicles to turn on a radius (right front wheel) of approximately 65 ft and still clear turning roadway by about 1 ft on each side.

Figure 5.2.5.4-e Turning Roadway Design for Passenger Car and Occasional SU-30



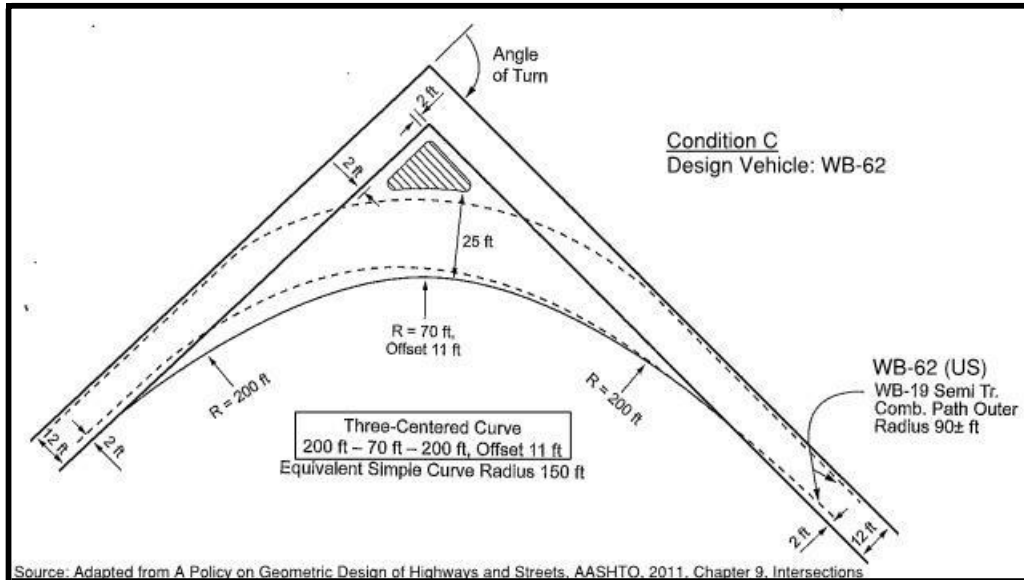
By increasing the turning roadway width 2 ft and using the same combination of curves but with the middle curve being offset 7 ft from the tangent edges extended, a more desirable arrangement results as shown in Figure 5.2.5.4-f. This design enables the single unit truck design vehicles to use a 75 ft turning radius with adequate clearances and makes it possible for the WB-62 design vehicle to negotiate the turn with only slight encroachment on adjacent through-traffic lanes.

Figure 5.2.5.4-f Turning Roadway Design for SU-30 and Occasional WB-62



At locations where a significant number of semitrailer combinations, particularly the longer units, will be turning, the arrangements shown should be used as shown in Figure 5.2.5.4-g. This design, consisting of a minimum curve of 70 ft radius, an offset of 11 ft and terminal curves with radii of 200 ft generally provides for WB-62 design vehicle passing through a 25 ft turning roadway width and greatly benefits the operation of smaller vehicles.

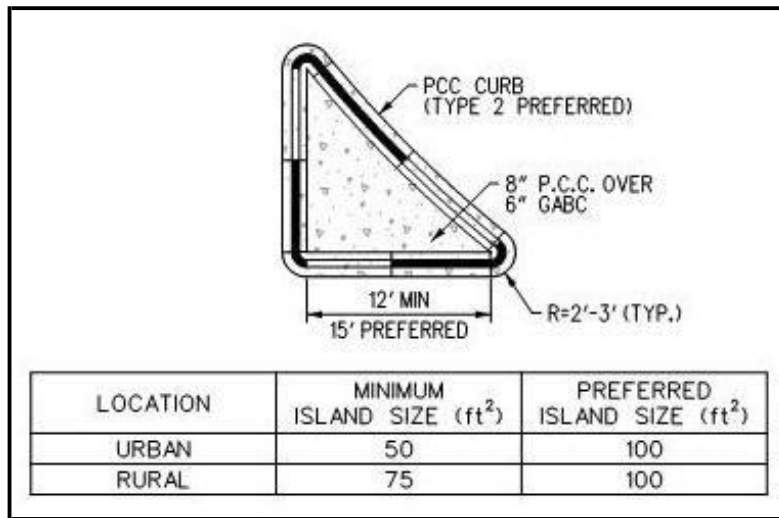
Figure 5.2.5.4-g Turning Roadway Design for WB-62



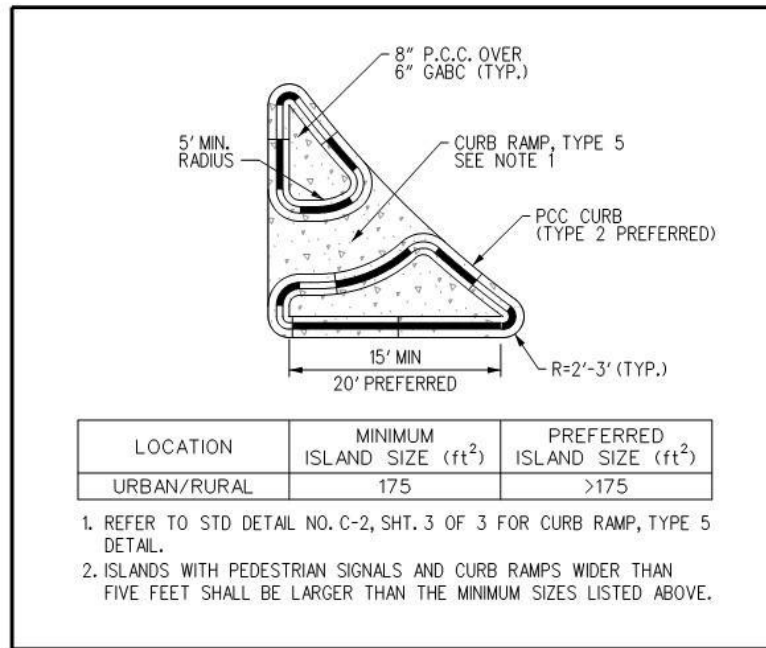
### 5.2.5.5 Channelizing Islands

An island's principle functions are to control and direct traffic movements, usually turning, dividing opposing and same direction traffic streams and to provide refuge for pedestrians and bicyclists. An island is defined as an area between traffic lanes for control of vehicle movements and may be delineated by barrier curb (having a vertical rise greater than 6 inches), mountable curb (having a vertical rise 6 inches or less) or a pavement area marked by paint. P.C.C. curb, Type 2 is the preferred curb used to delineate an island. Islands should be sufficiently large to be visible to motorists and to accommodate pedestrian refuge and pedestrian signal poles where required. Figures 5.2.5.5-a and 5.2.5.5-b provide minimum and preferred island sizes as stated in [Section 7.3.3 Islands](#) of DelDOT's *Road Design Manual*.

Figure 5.2.5.5-a Island Sizes without Pedestrians Facilities



**Figure 5.2.5.5-b Island Sizes with Pedestrians Facilities**



[Design Guidance Memorandum 1-22](#) provides additional guidance related to an island’s offset from the travel lane based on several conditions. Typically, the island is offset from the traveled way the full width of the shoulder or turn lane. This offset may be reduced to only five feet to accommodate bicycles (as shown in Figure 5.2.5.5-c) under the following conditions:

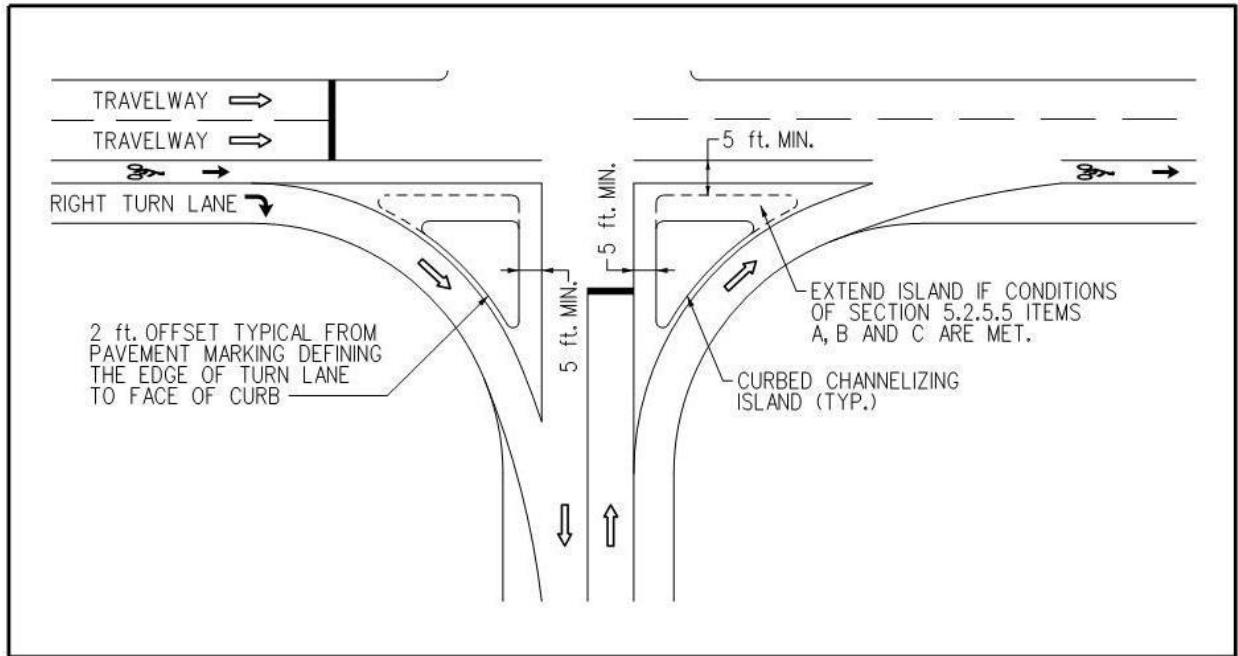
- A. Urban, suburban and developing areas where, due to queue lengths and congestion, there is a need to discourage traffic from using the shoulder to pass on the right
- B. Commercial driveway entrances or streets leading up to an urban, suburban or developing intersection to prevent illegal shoulder traffic prior to the deceleration lane. Here, the island also offers protection to the vehicle entering the highway and prevents a car crossing the highway entering the business or side street from being involved in an angle crash.
- C. Crosswalks where pedestrian refuge and shortening the length of the crossing is needed, particularly where there is signalization

As stated in the AASHTO Green Book, “islands used for channelization should not interfere with or obstruct bicycle lanes at intersections.” The offset for bicycles may be reduced to 4 feet at locations of high pedestrian use to minimize crossing time.

If U-turn movements are permitted on the intersecting roadway where channelizing islands are proposed to extend into the shoulder, then U-turn turning movement diagrams shall be prepared and submitted for review to verify that U-turn movements may still be made or to determine if additional signing or movement restrictions are needed for certain design vehicles.



Figure 5.2.5.5-c Triangular Island Offsets



For every island configuration, positive drainage must be provided for the safety of vehicles and pedestrians. The corners of the island shall be flush with the pavement as per the *Standard Specifications* for snow plowing operations. The corners of islands which are not offset the full width of the shoulder adjacent to the roadway shall be delineated with flexible delineators as per the *Standard Specifications* Section 701.11. See [Chapter 7 Intersections](#) of the *Road Design Manual* for additional information.

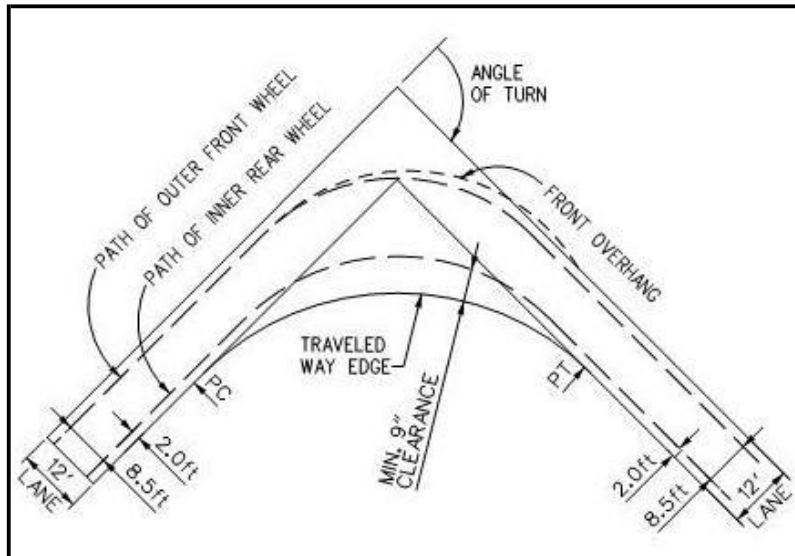
Prior to finalizing the island design, the engineer shall verify that the minimum island size listed in Figures 5.2.5.5-a and 5.2.5.5-b have been met. If the island size is not met using the recommended three centered compound curve radii from Figure 5.2.5.4-d, then the curve radii and/or offsets should be increased until the required minimum island size is achieved.

### 5.2.5.6 Turning Movement Diagrams

Based on the design vehicle chosen for the proposed development, turning movement diagrams shall be included with the initial plan submittal to verify that the minimum requirements for edges of traveled way for the design vehicle, drive aisle widths and channelizing islands sizes are met. Proposed pavement markings and an elevation view of the design vehicle must be shown on the diagrams. If u-turn movements will be permitted at intersections, then include the turning movements on the diagrams. If a signal is proposed at the intersection, then electronic files shall be forwarded to the Traffic Section to begin signal design only after these design features have been verified.

The design vehicle shall be properly positioned within the traffic lane at the beginning and end of the turn with a 2 foot offset from the edge of traveled way on the tangents. It is recommended to maintain the 2 foot offset of the design vehicle's inner wheel path throughout most of the turn and with a clearance at no point less than 9 inches from the face of curb or edge of pavement if uncurbed as shown in Figure 5.2.5.6-a. If a turning software application is used to create the templates, a minimum 10 mph speed shall be used for the design vehicle.

Figure 5.2.5.6-a Turning Movement Offsets

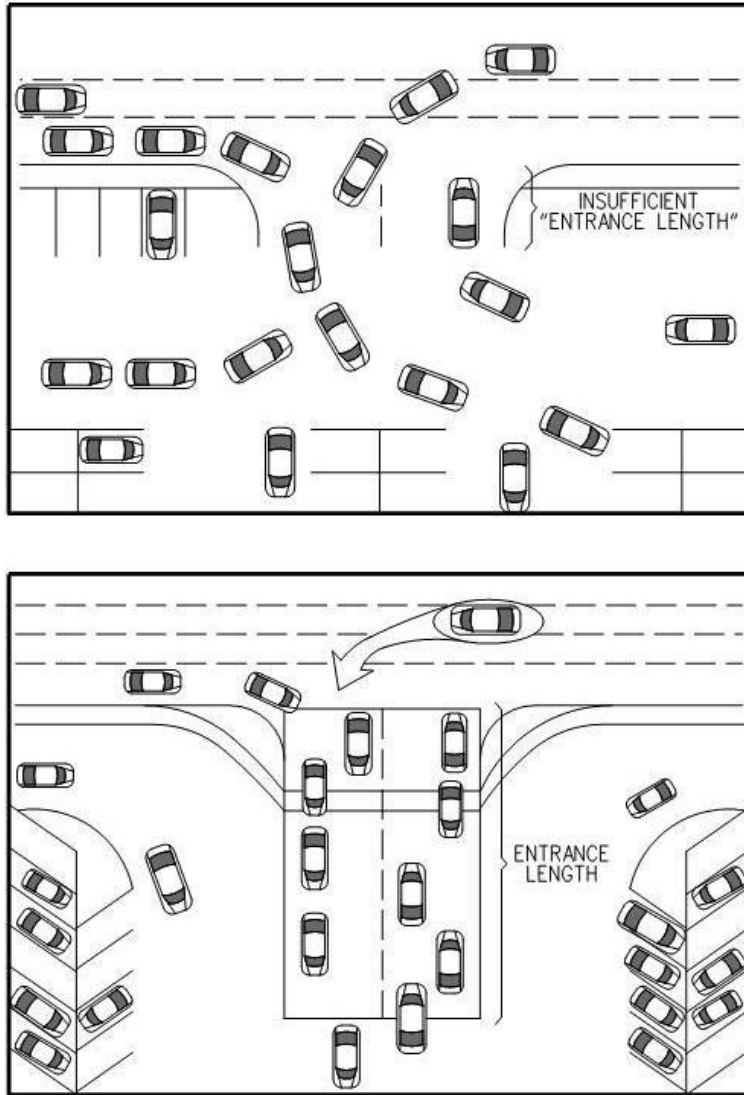


### 5.2.6 Subdivision and Commercial Entrance Design Guidelines – Entrance Length

The entrance length refers to the amount of space available for stacking incoming and outgoing vehicles or the distance between the street and the end of the entrance within the development. As shown in Figure 5.2.6-a, when insufficient lengths between the entry point and parking spaces or on-site drive aisles exist, vehicles can be subject to multiple conflict points near the entrance which inhibit operations on the adjacent roadway as well as within the developed site. Figure 5.2.5-b shows recommended minimum entrance lengths based on proposed land uses.

If the use of an entrance is to be controlled by an electronic gating system, the gate shall be located a minimum of 50 feet from the edge of the shoulder, and a turnaround for the appropriate design vehicle must be provided within the site entrance, in the area between the Right-Of-Way and the gates. For proposed uses that would be anticipated to create a queue of vehicles waiting to pass through the gating system, additional storage length may be required between the Right-Of-Way and the gates.

**Figure 5.2.6-a Entrance Length Example**



Source: Michigan Department of Transportation *Access Management Guidebook*

**Figure 5.2.6-b Recommended Minimum Entrance Lengths**

Land Use	Entrance Length
“Big Box” centers with four or more total lanes at the entrance.	300 feet
Regional Shopping Centers over 150,000 s.f.	250 feet
Community Shopping Centers between 100,000 sf and 150,000 s.f.	150 feet
Small Strip Shopping Center	50 feet
Small Commercial Developments	50 feet

*Note: For large developments 100,000 s.f. or greater, the total recommended length is not necessary for all entrances, only the major ones.*

Considerations for entrance length are especially important when the proposed use includes an element of drive-thru service such as fast-food restaurants, banks, and pharmacies. It is important that sufficient length be provided to allow the queuing of vehicles at drive-thru windows to be contained within the site and not back up into lanes of the adjacent roadway. Figure 5.2.5-c provides recommended queue distances for design consideration based on land use and the expected maximum number of queued vehicles.

**Figure 5.2.6-c Recommended Drive-thru Queue Distances**

Use	Expected Maximum Number of Queued Vehicles	Queue Distance Required
Fast-food restaurant	9	225 feet
Bank	7	175 feet
Car Wash	2	50 feet
Pharmacy	4	100 feet

*Notes:*

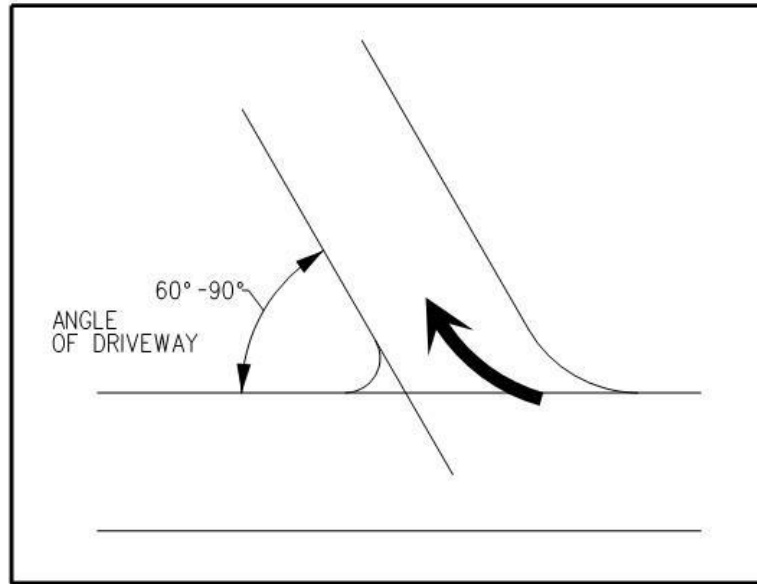
1. *Queue Distance Required is based on assuming 25 feet per queued vehicle.*
2. *The Expected Maximum Number of Queued Vehicles shown above are given as general guidelines: it is the responsibility of the design engineer to provide adequate space for queued vehicles on-site based on expected arrival rates, service rates, and the number of drive thru windows provided. The design engineer may be asked to provide such calculations at the discretion of the reviewer.*

**5.2.7 Subdivision and Commercial Entrance Design Guidelines – Horizontal Alignment**

Horizontal alignment of two-way entrance drives should be designed to intersect the frontage road at 90° whenever possible. Skewed intersections can reduce visibility of approaching motor vehicles, require higher degrees of traffic control, require more pavement to facilitate turning vehicles, and require greater crossing distances for pedestrians. If this is not possible due to field conditions, then the intersection angle must always be greater than 70°.

One-way commercial entrance drives may be used having a range of 60° to 90° without interfering with the motorists’ visibility as shown on Figure 5.2.7-a.

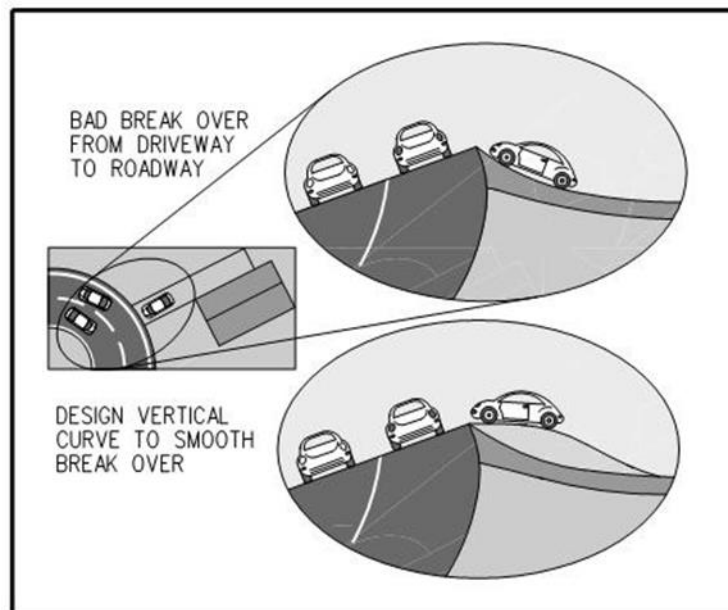
**Figure 5.2.7-a Angle of Driveway**



**5.2.8 Subdivision and Commercial Entrance Design Guidelines – Vertical Alignment**

Vertical alignment of entrances with the adjacent roadway is an important design consideration. Vehicles must slow down to traverse abrupt changes in grade, creating increased speed differentials with the adjacent roadway which increases crash potential. Another concern is the visibility of the entrance. For example, an entrance that slopes down and connects with a roadway on a superelevated horizontal curve can create issues with sight distance (see Figure 5.2.8-a).

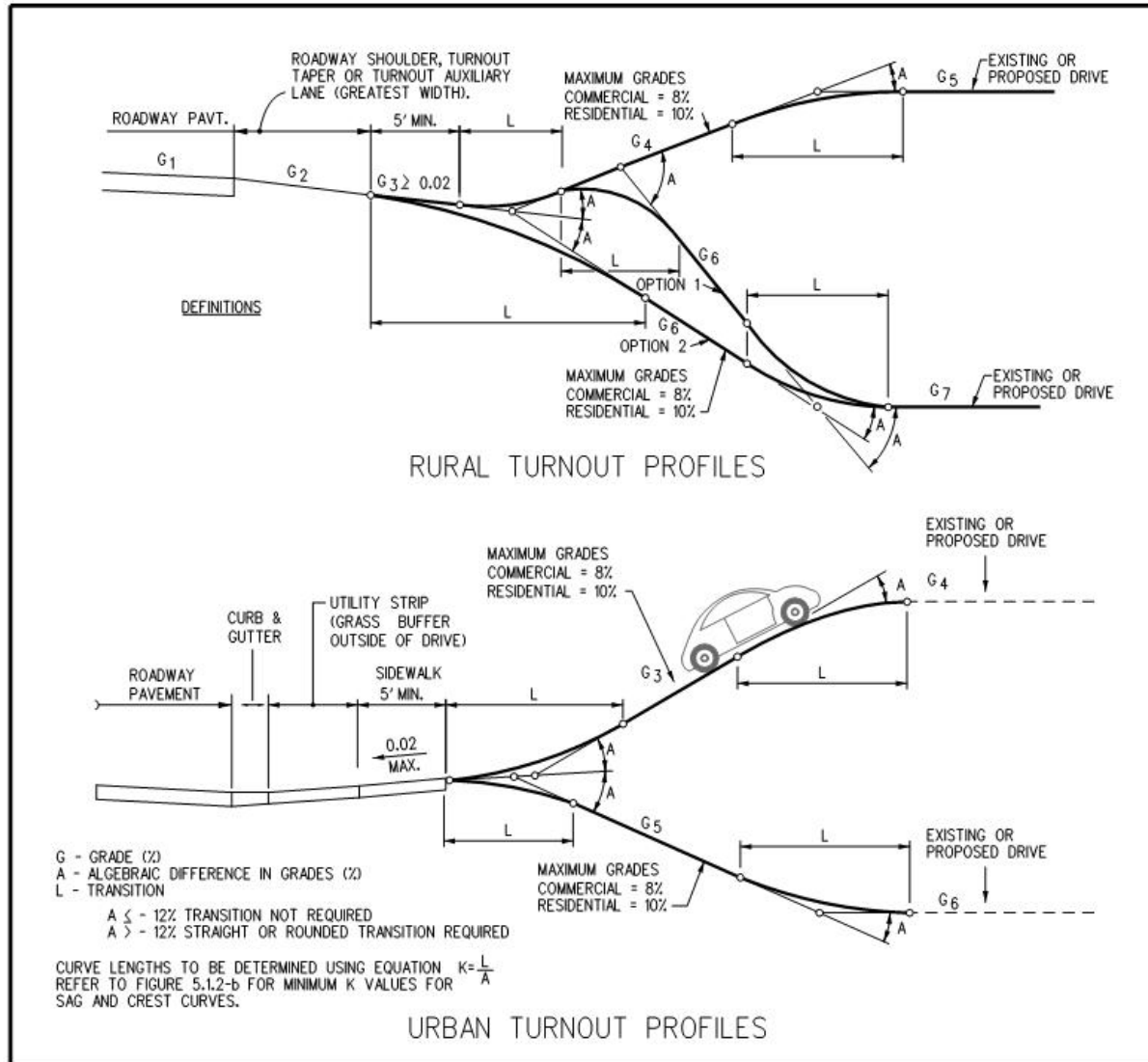
**Figure 5.2.8-a Vertical Alignment at an Entrance**



(Source: Florida Department of Transportation *Driveway Information Guide*)

Profiles of entrances shall be designed to include vertical curves at their intersections with adjacent roadways using the design criteria shown in Figure 5.2.8-b. Vertical curve transition shall be provided at the intersection of the entrance profile and the cross slope of the roadway shoulder extended. Transition lengths should be based on minimum K-values listed in Figure 5.1.2-a. Minimum grades should be 0.5% and maximum grades should not exceed 8% for commercial entrances and 10% for residential entrances. Special design consideration must also be given to locations where pedestrian crossing facilities are proposed at entrances. All sidewalk, curb ramp, and crosswalk longitudinal slopes and cross slopes must adhere to applicable regulations and should follow DelDOT guidance for achieving Americans with Disabilities Act (ADA) compliance.

Figure 5.2.8-b Entrance Drive Tie-in to Frontage Road



(Source: Florida Department of Transportation *Driveway Information Guide*)

## 5.2.9 Subdivision and Commercial Entrance Design Guidelines – Auxiliary Lanes

When turning movements are introduced to a roadway, speed differentials between turning vehicles and through traffic are created. These differentials have a detrimental effect on both crash potential and level of service. Auxiliary lanes provide an area for turning traffic to be separated from the through lanes in an effort to improve safety and capacity of the roadway. Auxiliary lanes include right-turn lanes, left-turn lanes, bypass lanes, and crossovers. Auxiliary lane length should be dictated by traffic volumes, composition, speeds, desired level-of- service, and local conditions. Auxiliary lane warrants and lane lengths shall be determined in accordance with this section. Projects shall demonstrate compliance by completing DelDOT’s Auxiliary Lane Worksheet available in the “Doing Business” section of DelDOT’s website available online. Projected 10-year roadway ADT shall be calculated by multiplying the roadway AADT by the “10-Year Growth Factor” (which is established as 1.16 based on assumed 1.5% annual growth in the Auxiliary Lane Worksheet or provided by DelDOT if a TOA/TIS is performed) and multiplied by the associated K and D factors from the latest DelDOT *Traffic Summary Report*, (published on the DelDOT website annually under “*Vehicle Volume Summary (Traffic Counts)*” at: [https://deldot.gov/Publications/manuals/traffic\\_counts/index.shtml](https://deldot.gov/Publications/manuals/traffic_counts/index.shtml) and then adding any known committed development and site approach traffic volumes. If traffic counts are collected or a TOA/TIS is performed, those traffic volumes can be utilized instead of applying the associated K and D factors. Projected 10-year roadway ADT shall be used for the analysis. The “Traffic Generation Input Tab-1” and “Aux Lane Inputs – Tab 2” on the Auxiliary Lane Worksheet shall be completed and submitted for review for each proposed entrance. If the entrance is to be signalized, the “Signalized Intersection-Tab 7” tab shall also be completed and submitted for review for each proposed entrance.

### 5.2.9.1 Right-Turn Lane

Right-turns can be free flowing, yield or stop-controlled. In order to operate properly, free flowing right-turn lanes must have an adequate deceleration distance, with no access points, for drivers to safely merge with and diverge from the through traffic. Separate right-turn lanes at signalized and unsignalized intersections shall be required when warranted in accordance with this section. Projects shall demonstrate compliance by completing DelDOT’s Auxiliary Lane Worksheet. Right-turn lanes shall be designed in accordance with Figure 5.2.9.1-a and b. A five foot bike lane shall be provided between the adjacent travel lane and right-turn lane to accommodate bicycles. Listed below are notes related to the warrants and right turn lane lengths:

- A. The tables provided in Figures 5.2.9.1-a and 5.2.9.1-b are based on the following criteria:
  - 1. Roadway grades are between -3% and +3%
  - 2. Site's percentage of heavy vehicles making right-turn movements is less than 10% of the site's total right turn movements
- B. All right turn deceleration lengths include a 50-foot taper length
- C. An additional 25 feet of deceleration length is included in right turn length if the site's percentage of heavy vehicles making right-turn movements is equal to or greater than 10% of the site's total right turn movements.
- D. Deceleration lengths are determined by adding Stopping Sight Distance and Storage Length and rounding up to the nearest 5 feet.
- E. Minimum Deceleration Length as follows:
  - 1. 100 feet for 10-Year Roadway ADT  $\leq$  4,000 vehicles and Posted Speed  $\leq$  35 MPH
  - 2. 135 feet for 10-Year Roadway ADT  $>$  4,000 vehicles, Posted Speed  $>$  35 MPH and  $R > 50'$
  - 3. 150 feet for 10-Year Roadway ADT  $>$  4,000 vehicles, Posted Speed  $>$  35 MPH and  $R \leq 50'$
- F. If the entrance is an existing access point serving more than the proposed use, right-turn ADT shall include site traffic and existing roadway traffic executing the right-turning movement.



G. A right-turn lane is not warranted when:

1. Right-turn ADT  $\leq 100$  and projected 10-year roadway ADT  $\leq 4,000$
2. Right-turn ADT  $\leq 50$  and projected 10-year roadway ADT  $> 4,000$

H. The tables are for unsignalized intersections only. For signalized intersections complete the “Signalized Intersection-Tab 6” tab of DelDOT’s Auxiliary Lane Worksheet.

**Figure 5.2.9.1-a Right Turn Lane Warrants ( $R \leq 50'$ )**

Projected 10-Year Roadway ADT	Right-turn ADT	Assumed Speed Change on Through Lane	Highway Posted Speed					
			25 MPH	35 MPH	40 MPH	45 MPH	50 MPH	55 MPH
			Deceleration Length					
Less Than 2,000 Vehicles	0-100	-	-	-	-	-	-	-
	101 - 200	20 MPH	100	100	150	160	195	240
	Over 200	15 MPH	100	125	160	195	240	290
2,000 to 4,000 Vehicles	0-100	-	-	-	-	-	-	-
	101 - 200	20 MPH	100	100	150	160	195	240
	201 - 400	15 MPH	100	125	160	195	240	290
	Over 400	10 MPH	100	160	195	240	290	340
4,001 to 10,000 Vehicles	0-50	-	-	-	-	-	-	-
	51 - 100	20 MPH	150	150	150	160	195	240
	101 - 200	15 MPH	150	150	160	195	240	290
	201 - 400	10 MPH	150	160	195	240	290	340
	Over 400	5 MPH	150	195	240	290	340	400
Over 10,000 Vehicles	0-50	-	-	-	-	-	-	-
	51 - 100	15 MPH	150	150	160	195	240	290
	101 - 200	10 MPH	150	160	195	240	290	340
	201 - 400	5 MPH	150	195	240	290	340	400
	Over 400	0 MPH	160	240	290	340	400	460

Assumptions

1. Vehicle Length (ft): 25
2. Brake Reaction time,  $t$  (sec): 1
3. Full deceleration to 0 mph (stop condition)
4. Stopping Sight Distance determined, using methodology adopted from the AASHTO Green Book, as follows:
  - a. Per Eq. 3-1, Braking distance on level,  $d_1 = 1.075 * (V_{design\ speed})^2 / a$ ,  $a = 11.2\ ft/s^2$
  - b. Per Eq. 3-2, Brake reaction distance,  $d_2 = 1.47 * (V_{design\ speed}) * t$
  - c. Per Eq. 3-3, Brake distance on grade,  $d_3 = (V_{design\ speed})^2 / (30 * (a/32.2) \pm G)$ ,  $a = 11.2\ ft/s^2$ ;  $G =$  percent of grade divided by 100
  - d. AASHTO equations reference design speed which DelDOT defines as posted speed + 5 mph.
5. A practical minimum storage length of 25 feet (1 vehicle) is included in the deceleration length as per the NCHRP 457, page 24.
6. All right turn deceleration lengths include a 50-foot taper length.
7. See Auxiliary Lane Worksheet for visual display of calculating total roadway ADT

Figure 5.2.9.1-b Right Turn Lane Warrants (R>50')

Projected 10-Year Roadway ADT	Right-turn ADT	Assumed Speed Change on Through Lane	Highway Posted Speed					
			25 MPH	35 MPH	40 MPH	45 MPH	50 MPH	55 MPH
			Deceleration Length					
Less Than 2,000 Vehicles	0-100	-	-	-	-	-	-	-
	101 - 200	20 MPH	-	100	135	135	150	195
	Over 200	15 MPH	-	100	135	150	195	240
2,000 to 4,000 Vehicles	0-100	-	-	-	-	-	-	-
	101 - 200	20 MPH	-	100	135	135	150	195
	201 - 400	15 MPH	-	100	135	150	195	240
	Over 400	10 MPH	100	110	150	195	240	295
4,001 to 10,000 Vehicles	0-50	-	-	-	-	-	-	-
	51 - 100	20 MPH	-	135	135	135	150	195
	101 - 200	15 MPH	-	135	135	150	195	240
	201 - 400	10 MPH	135	135	150	195	240	295
	Over 400	5 MPH	135	150	195	240	295	355
Over 10,000 Vehicles	0-50	-	-	-	-	-	-	-
	51 - 100	15 MPH	-	135	135	150	195	240
	101 - 200	10 MPH	135	135	150	195	240	295
	201 - 400	5 MPH	135	150	195	240	295	355
	Over 400	0 MPH	135	195	240	295	355	415

Assumptions

1. Vehicle Length (ft): 25
2. Brake Reaction time, t (sec): 1
3. Deceleration to 15 mph (turning design speed of a corner radius > 50 feet adopted from the DelDOT Road Design Manual)
4. Stopping Sight Distance determined by adding the Brake Reaction Distance, (adopted from AASHTO Green Book) and the Braking Distance on Level from the Uniform Acceleration Formula (UAF) as follows:
  - a. Per Eq. 3-2, adopted from the AASHTO Green Book, Brake reaction distance,  $d_1 = 1.47 * (V_{design\ speed}) * t$
  - b. Per UAF, Braking distance on level from Design Speed to 15 mph,  $d_2 = ((1.47 * 15\ mph)^2 - (1.47 * V_{design\ speed})^2) / 2a$ ,  $a = -11.2\ ft/s^2$
  - c. Per UAF, Braking distance on grade from Design Speed to 15 mph,  $d_2 = ((1.47 * 15\ mph)^2 - (1.47 * V_{design\ speed})^2) / 2 * (-32.2 * (0.35 \pm G))$ ; G = percent of grade divided by 100
  - d. Equations reference design speed which DelDOT defines as posted speed + 5 mph.
5. A practical minimum storage length of 25 feet (1 vehicle) is included in the deceleration length as per the NCHRP 457, page 24.
6. All right turn deceleration lengths include a 50-foot taper length.
7. See Auxiliary Lane Worksheet for visual display of calculating total roadway ADT

**5.2.9.2 Bypass Lane**

A bypass lane is a paved shoulder that permits through traffic to bypass a left-turning vehicle which is stopped on the travel lane. They are intended to reduce delay and expedite the movement of through traffic at T- intersections.

An intersection shall first be considered for a bypass lane using the warrants in accordance with Figure 5.2.9.2-a of this section. Projects shall demonstrate compliance by completing DelDOT’s Auxiliary Lane Worksheet. Bypass lanes shall be designed in accordance with Figure 5.2.9.2-b. A five foot shoulder shall be provided on the outside of the bypass lane to accommodate bicycles.

Listed below are notes related to the warrants and bypass lane lengths:

- A. Bypass lanes will not be permitted in the following locations:
  - 1. On roads with a projected 10-year roadway ADT > 8,000 vpd
  - 2. Where an existing entrance or street lies within the limits of the proposed bypass lane, including at intersections where the proposed entrance creates the fourth leg. Separate worksheets shall be completed and submitted for review of both the proposed entrance and the existing entrance or street to determine if either entrance would meet the bypass lane warrants and thereby trigger the need for left turn lane(s).
  - 3. Signalized intersections. The table provided in Figure 5.2.9.2-a is for unsignalized intersections only, coordinate with the DelDOT Traffic Impact Studies Group to determine left turn lane warrants and required lengths at signalized intersections, (see the “Signalized Intersection-Tab 6”, of the Auxiliary Lane Worksheet for additional guidance)
  - 4. On roads with more than 2 through lanes (such as if there are already two through lanes where a bypass would be created)
  - 5. On roads where physical characteristics limit the ability to provide adequate sight distance meeting DelDOT’s requirements. Inadequate intersection sight distance would trigger the need for left turn lane(s).
- B. If any of the conditions listed in Section 5.2.9.2.A exist, then the left turn lane warrants will be evaluated in accordance with Section 5.2.9.3.
- C. For unique conditions, such as at age-restricted communities or schools where there is a need to accommodate drivers who may wait for longer gaps to make left turns, DelDOT Subdivision Engineer may require a bypass lane.
- D. For any special cases with very low opposing volumes, DelDOT’s Subdivision Engineer may waive the requirement of a bypass lane.
- E. If a bypass lane is warranted, alternative intersection designs may be considered at DelDOT’s discretion.
- F. If the opposing right-turn movement is channelized, a reduction of 100% can be applied to the opposing right-turning volumes (vph) resulting in a decrease to the projected 10-year opposing volumes (vph). Although a right-turn movement may be channelized, DelDOT Subdivision Engineer may limit the reduction due to site design constraints. A channelized right-turning movement shall encompass the following characteristics:
  - 1. A right-turn lane meeting the criteria set forth in Section 5.2.9.1
  - 2. A channelized island designed in accordance with Section 5.2.5.5
- G. If the entrance is an existing access point serving more than the proposed use, the left-turn peak hour volumes (vph) as well as the right-turn ADT and peak hour opposing volumes (vph) shall include site traffic and existing roadway traffic executing those movements.

**Figure 5.2.9.2-a Bypass Lane Warrants**

Projected 10-year Roadway AADT	Projected 10-Year Opposing Volume (vph)	Left-Turning Vehicles (vph)					
		Less than 10	10-14	15-20	21-30	31-40	Over 40
		Storage Length (feet)					
Less than 1,500 Vehicles	Over 100	-	-	-	50	50	50
1,500 to 2,000 Vehicles	0* – 400	-	-	50	50	50	See Left-Turn Lane Warrants
2,001 to 4,000 Vehicles	0* - 100	-	50	50	50	50	
	101 - 200	-	50	50	50	50	
	201 - 300	-	50	50	50		
	301 – 400	-	50	50	50		
	Over 400	-	75	75			
4,001 to 8,000 Vehicles	*	-	75				
Over 8,000 Vehicles	*	-					

\*See Section 5.2.9.2.D and Section 5.2.9.3.J for special cases with very low opposing volumes

Posted Speed (mph)	Approach Taper Length (feet)
25	Bypass Lane Not Warranted
30	125
35	155
40	155
45	180
50	215
55	250

Posted Speed (mph)	Departure Taper Length (feet)
25	Bypass Lane Not Warranted
30	65
35	80
40	80
45	90
50	110
55	125

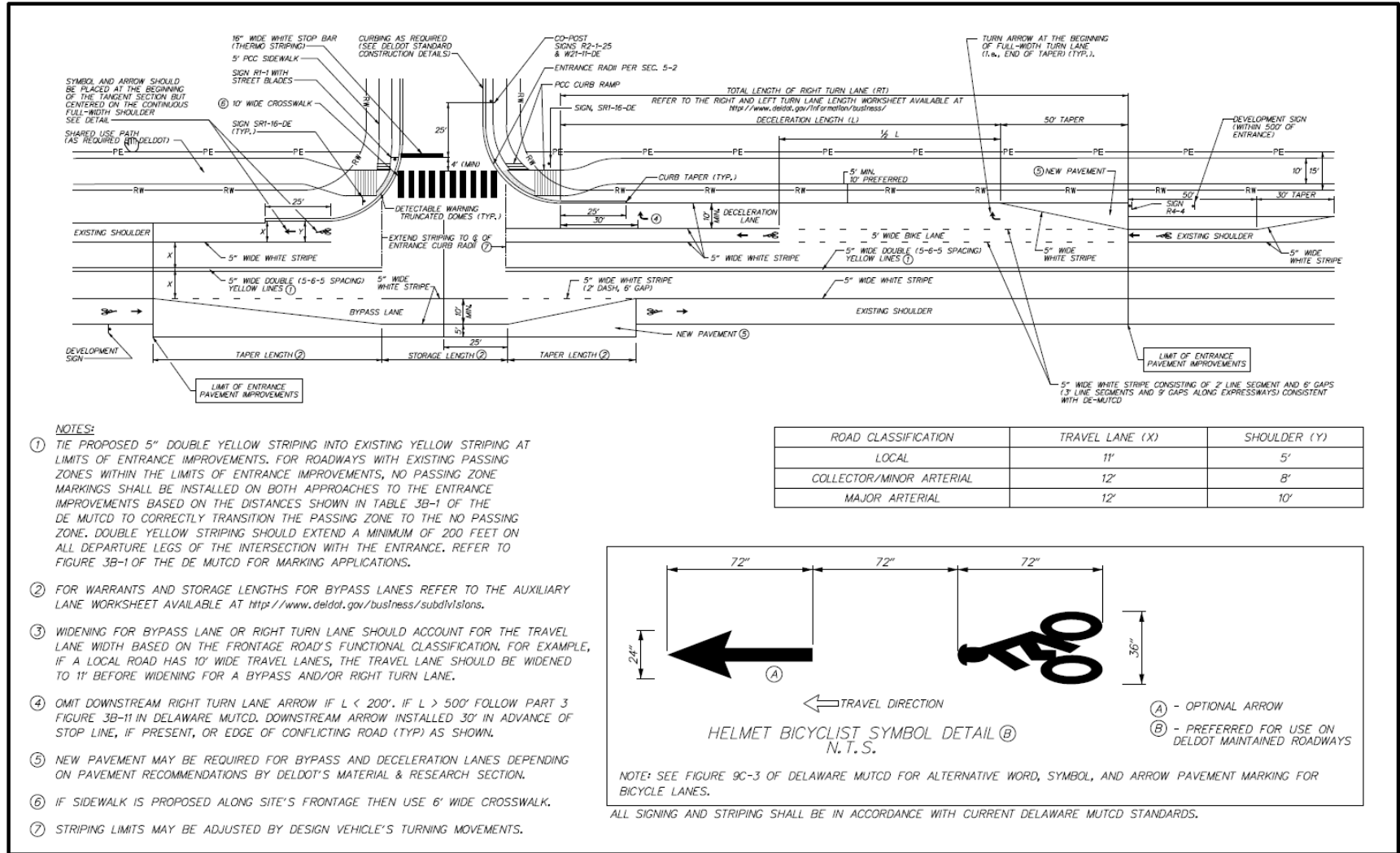
**Notes:**

1. Bypass lanes are not allowed on roads with a projected 10-year roadway ADT > 8,000 vpd.
2. Bypass lane is only for two lane roadways. If bypass lane warrant is satisfied for a 4 lane section, then it will automatically warrant a left turn lane (see Section 5.2.9.3).

Assumptions:

1. Vehicle Length (ft): 25
2. Brake Reaction time,  $t$  (sec): 2.5
3. Assumes the following speed reduction from posted speed limit in through lane:
  - a. 0 mph for 25 - 35 mph posted speed
  - b. 5 mph for 40 - 55 mph posted speed
4. Stopping Sight Distance adopted from Table 3-1 from AASHTO Green Book
  - a. AASHTO equation and exhibit references design speed which DelDOT defines as posted speed + 5 mph.
  - b. Approach Taper Length = Stopping Sight Distance/2.0
  - c. Departure Taper Length = Stopping Sight Distance/4.0
5. Queue Storage and Taper Lengths listed in chart are rounded up to the nearest 5'.
6. Queue Storage length calculated as per Transportation Research Record (TRR) 1500, Lengths of Left-Turn Lanes at Unsignalized Intersections, p.193.
  - a. The required space for the first vehicle in the queue is 15 ft because no buffer zone is needed between the first car and the stop line.
  - b. Proportion of Heavy Vehicles (%) = 5%
  - c. Left-Turn from Major Road on a Two or Four-Lane Roadway
  - d. Critical Headway (sec) = 4.2 (in this case, based on the assumptions listed above)
    - i. Per the HCM 2010, Equation 19-30, Critical Headway = Base critical headway + (adjustment factor for heavy vehicles \* % of HV). For example, using 5% of Heavy Vehicles; Critical Headway =  $4.1 + (2 * 0.05) = 4.2$
    - ii. The values on the critical headway tables from TRR 1500, pages 197-198, have been adapted to always include a minimum of one vehicle storage or 15'.
    - iii. Based on the Proportion of Heavy Vehicles (truck %) selected, critical headway values 4.1-4.9, 5.1 and 5.5 are used
  - e. Threshold Probability of Overflow = 0.015; From TRR 1500, p. 194
  - f. Storage Length = (Lane Length in Number of Vehicles \* Vehicle Length) + 25 ft
  - g. 25 ft length represents 25 ft on departure side of the entrance
7. See Auxiliary Lane Worksheet for visual display of calculating Total Roadway ADT

Figure 5.2.9.2-b Typical Entrance Diagram with Bypass Lane



### 5.2.9.3 Left-Turn Lane

Separate left-turn lanes shall be required on signalized and unsignalized intersections of roadways when warranted. If left turns are proposed on roads with an Arterial classification, or roads with 2 or more travel lanes that must be crossed, the project shall be referred to DelDOT prior to start of site design for an access determination, in accordance with applicable sections such as 1.5.2 *Arterials - Design Standards* or 1.2.1 *Entrance Policy - Location of Entrances*, prior to allowing the left turning movement or designing an auxiliary lane, (such as a left-turn lane, a two way left turn lane or other traffic storage facility). When it is determined that a project shall generate sufficient number of left-turns to warrant the construction of an auxiliary lane to accommodate left-turns, it shall be the responsibility of the developer to construct an auxiliary lane, (such as a left-turn lane or other traffic storage facility as directed by DelDOT), at the locations designated by DelDOT. Left turn lanes when permitted shall be designed in accordance with Figure 5.2.9.3-b. Raised medians should be considered and designed in accordance with applicable guidelines and standards such as: Chapters 4 and 9 of AASHTO's *Policy on Geometric Design of Highways and Streets (The Green Book)* or other **NAS**.

A separate left-turn lane shall be required for all signalized entrances located on roadways. The design shall be in accordance with applicable standards and guidelines such as the *Highway Capacity Manual (HCM)* or **NAS**. When access to a proposed site requires vehicles to utilize an existing left-turn lane, the existing facility shall be evaluated for compliance with the requirements of this section, and the appropriate configuration shall be demonstrated using the Auxiliary Lane Worksheet, to determine if modifications are needed to provide sufficient storage length. The developer will be required to make any modifications necessary to provide an adequate left- turn lane.

Listed below are notes related to the warrants and left turn lane lengths:

- A. The table provided in Figure 5.2.9.3-a is based on the following criteria:
  1. Roadway grades are between -3% and +3%
  2. Left-turn movements from major 2 or 4-lane roadway. Contact DelDOT Development Coordination Section when the left-turn movements are from a roadway having more than 4 travel lanes
  3. Left-turn movement volume with Heavy Vehicles (HV)  $\leq 5\%$
  4. Opposing volumes are less than 1200 vph OR left-turning vehicles per hour are less than 400 vph. If volumes are greater than specified limits, then the engineer shall submit an intersection and traffic signal analysis to the Development Coordination Section for review.
- B. Opposing Volume (vph) is the total volume of vehicles on the approach across from (and heading in the opposite direction of) the left-turn movement under analysis. The opposing volumes shall be calculated by adding any known committed development traffic volumes (including traffic generated from secondary entrances of the site under analysis) to the Projected 10-year roadway ADT.
- C. If an entrance is proposed across from an existing entrance or street to create a four-legged intersection, then separate worksheets shall be completed and submitted for review of both the proposed entrance and the existing entrance or street. For any four-legged intersection, the need for a left-turn lane on one approach to the intersection will trigger DelDOT's determination of the need to create a reciprocal "shadowed" left-turn lane including the minimum storage length and taper on the opposing approach.
- D. Left-turn lanes may be required when physical characteristics limit the ability to provide adequate sight distance meeting DelDOT's requirements for intersection sight distance, (such as those adopted from AASHTO's standards or other **NAS**).
- E. For unique conditions, such as at age-restricted communities or schools where there is a need to accommodate drivers who may wait for longer gaps to make left turns, DelDOT Subdivision Engineer may require a left turn lane.

- F. Queue storage length may need to be greater, (depending on the design vehicle or proposed use), than the length given by the design methodology outlined in this chapter and demonstrated through the completion of the Auxiliary Lane Worksheet.
- G. If a left turn lane is warranted, alternative intersection designs may be considered at DelDOT's discretion.
- H. If the opposing right-turn movement is channelized, a reduction of 100% can be applied to the opposing right-turning volumes (vph) resulting in a decrease to the projected 10-year opposing volumes (vph). Although a right-turn movement may be channelized, DelDOT Subdivision Engineer may limit the reduction due to site design constraints. A channelized right-turning movement shall encompass the following characteristics:
  - 1. A right-turn lane meeting the criteria set forth in Section 5.2.9.1
  - 2. A channelized island designed in accordance with Section 5.2.5.5
- I. If the entrance is an existing access point serving more than the proposed use, the left-turn peak hour volumes (vph) as well as the right-turn ADT and peak hour opposing volumes (vph) shall include site traffic and existing roadway traffic executing those movements.
- J. The following conditions apply for left-turning vehicle (vph) volumes less than 50 vph:
  - a. Left-turn lanes will not be required along roadways with 10-year Projected AADT < 1,500 vpd (See Section 5.2.9.2).
  - b. Left turn lane (having the recommended queue storage length shown in the table for 50 vph), will be warranted on roadways for any combination of conditions that include; left-turning vehicle volumes > 40 vph and a projected 10 yr roadway AADT  $\geq 1,500$  and  $\leq 2,000$ .
  - c. Left turn lane, (having the recommended queue storage length shown in the table for 50 vph), will be warranted on roadways for any combination of conditions that include; left-turning vehicle volumes > 40 vph, projected 10 yr opposing volumes  $\leq 200$ , and a projected 10 yr roadway AADT > 2,000 and  $\leq 4,000$ .
  - d. Left turn lane, (having the recommended queue storage length shown in the table for 50 vph), will be warranted on roadways for any combination of conditions that include; left-turning vehicle volumes > 30 vph , projected 10 yr opposing volumes > 200 and  $\leq 400$ , and a projected 10 yr roadway AADT > 2,000 and  $\leq 4,000$ .
  - e. Left turn lane, (having the recommended queue storage length shown in the table for 50 vph), will be warranted on roadways for any combination of conditions that include; left-turning vehicle volumes > 20 vph, projected 10 yr opposing volumes > 400, and a projected 10 yr roadway AADT > 2,000 and  $\leq 4,000$ .
  - f. Left turn lane, (having the recommended queue storage length shown in the table for 50 vph), will be warranted on roadways for any combination of conditions that include; left-turning vehicle volumes  $\geq 15$  vph and a projected 10 yr roadway AADT > 4,000 and  $\leq 8,000$ .
  - g. Left turn lane, (having the recommended queue storage length shown in the table for 50 vph), will be warranted on roadways for any combination of conditions that include; left-turning vehicle volumes  $\geq 10$  vph and a projected 10 yr roadway AADT > 8,000.
  - h. For any special cases with very low opposing volumes, DelDOT's Subdivision Engineer may waive the requirement of a left turn lane.
  - i. For any intersection/corridor with a high crash history, DelDOT's Subdivision Engineer may require a left turn lane.



K. The table is for unsignalized intersections only. For signalized intersections, coordinate with the DelDOT Traffic Impact Studies Group to determine left turn lane warrants and required lengths at signalized intersections, (see the “Signalized Intersection-Tab 6” tab of the Auxiliary Lane Worksheet for additional guidance).

Figure 5.2.9.3-a Left-Turn Lane Warrants at Unsignalized Intersections

QUEUE STORAGE (Feet)												
Left-Turning Vehicles (vph)	Projected 10-Year Opposing Volume (vph)											
	100	200	300	400	500	600	700	800	900	1000	1100	1200
50	15	15	15	40	40	40	40	40	40	65	65	65
100	15	15	40	40	40	65	65	65	65	65	90	90
150	15	40	40	40	65	65	65	90	90	90	115	115
200	15	40	40	65	65	90	90	90	115	115	140	140
250	40	40	65	65	90	90	90	115	115	140	165	190
300	40	40	65	65	90	90	115	140	140	165	190	240
350	40	40	65	90	90	115	140	140	165	190	240	290
400	40	65	65	90	115	115	140	165	190	240	290	365

Posted Speed (mph)	DECELERATION (Feet)*
25	135
35	180
40	180
45	220
50	270
55	325

LEFT-TURN LANE LENGTH (Feet) = QUEUE STORAGE + DECELERATION			
Input Data		Sample	
Queue Storage	Left-turning vehicles in vph	Input Data	Length from Table
	150	150	65
	600	600	220
Deceleration	Posted Speed in mph	45	220
Total Left-Turn Lane Length (feet)			285

\* Includes a 100-foot taper length

Assumptions

1. Vehicle Length (ft): 25
2. Brake Reaction time, t (sec): 1
3. Deceleration length includes 100' opening taper to left turn lane
4. Full deceleration to 0 mph (stop condition)
5. Braking reaction distance assumes the following speed reduction from posted speed limit in through lane:
  - a.. 0 mph for 25 - 35 mph posted speed
  - b.. 5 mph for 40 - 55 mph posted speed
6. Braking distance assumes the following speed reduction from posted speed limit in through lane:
  - a. 0 mph for 25 mph posted speed
  - b. 5 mph for 35 mph posted speed
7. Lengths determined, using methodology adopted from AASHTO Green Book, as follows:
  - a. Per Eq. 3-2, Brake reaction distance,  $d = 1.47 * V_{design} * t$
  - b. Per Eq. 3-1, Braking distance on level,  $d = 1.075 * ((V_{design} / a)^2)$ ,  $a = 11.2 \text{ ft/s}^2$  (-3% < Grade < 3%)

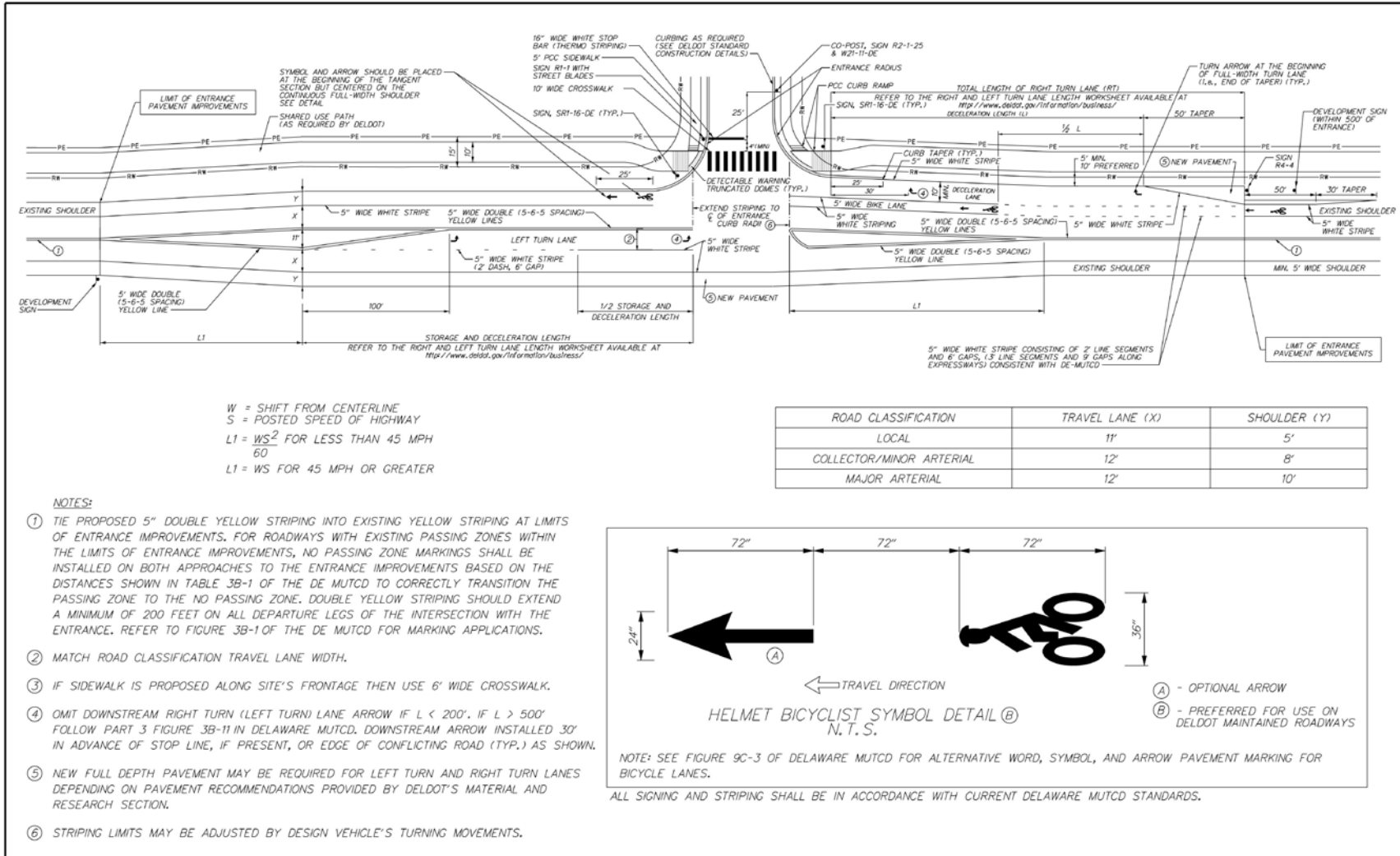
*DelDOT Development Coordination Manual*

- c. Per Eq. 3-3, Braking distance on grade,  $d = [(V_{design\ speed})^2 / (30 * (a/32.2) \pm G)]$ ,  $a = 11.2\ ft/s$ ,  $-3\% \geq G \geq 3\%$
- d. AASHTO equation and exhibit references design speed which DelDOT defines as posted speed + 5 mph.

Deceleration Length (ft) = Brake Reaction (ft) + Braking on Level (ft)	Posted Speed (mph)					
	25	35	40	45	50	55
Brake reaction distance	44.1	58.8	58.8	66.2	73.5	80.9
Braking distance on level	86.4	117.6	117.6	153.6	194.4	240
Stopping Sight Distance	131	177	177	220	268	321

- 8. Queue Storage and Deceleration Lengths listed in chart are rounded up to the nearest 5'.
- 9. Queue Storage length calculated as per Transportation Research Record (TRR) 1500, Lengths of Left-Turn Lanes at Unsignalized Intersections, p.193.
  - a. The required space for the first vehicle in the queue is 15 ft because no buffer zone is needed between the first car and the stop line.
  - b. Proportion of Heavy Vehicles (%) = 5%
  - c. Left-Turn from Major Road on a Two or Four-Lane Roadway
  - d. Critical Headway (sec) = 4.2 (in this case, based on the assumptions listed above)
    - i. Per the HCM 2010, Equation 19-30, Critical Headway = Base critical headway + (adjustment factor for heavy vehicles \* % of HV). For example, using 5% of Heavy Vehicles; Critical Headway = 4.1 + (2 \* 0.05) = 4.2
    - ii. The values on the critical headway tables from TRR 1500, pages 197-198, have been adapted to always include a minimum of one vehicle storage or 15'.
    - iii. Based on the Proportion of Heavy Vehicles (truck %) selected, critical headway values 4.1-4.9, 5.1 and 5.5 are used
  - e. Threshold Probability of Overflow = 0.015; From TRR 1500, p. 194
  - f. Storage Length = (Lane Length in Number of Vehicles \* Vehicle Length) - 10
- 10. Projected 10-Year Opposing Volume in vph = AADT \* K \* D \* 10-Year Growth Factor
  - a. AADT - From the DelDOT Traffic Summary Book
  - b. K and D factors from the TPG (Traffic Pattern Group) included in the most recent DelDOT Traffic Summary Reports
  - c. 10-Year Growth Factor = 1.16 (Assuming a 1.5% annual growth)
- 11. See Auxiliary Lane Worksheet for visual display of calculating Total Roadway ADT

Figure 5.2.9.3-b Typical Entrance Diagram with Left-Turn Lane



#### **5.2.9.4 Crossover**

Crossover design at two-lane crossroads or connecting roads should be in accordance with standard crossover design found in applicable guidelines, standards and manuals such as: Chapter 9 of AASHTO's *Policy on Geometric Design of Highways and Streets (The Green Book)* and DelDOT's RDM or other **NAS**.

The following general guidelines shall be used:

- A. The minimum length of opening width may be controlled by the median width and control radius of the design vehicle.
- B. The shape of the median end plays an important role in the design of the crossover and if u-turn movements will be permitted. For medians greater than 10 feet in width, bullet nose shape is preferred.
- C. Crossovers shall not be placed, regardless of existing spacing on highways, where DelDOT has determined that crossovers should not be added for reasons of safety or capacity.
- D. Crossovers shall not be placed on limited access highways under any circumstances.
- E. It is desirable to maintain an average spacing of 1,000 to 1,500 feet between crossovers in urban areas and 2,000 to 3,000 feet between crossovers in rural areas.
- F. Closer spacing shall be permitted when DelDOT finds it beneficial for traffic operations and safety. The absolute minimum spacing of crossovers shall be governed by the requirements for left-turn lanes to include required taper lengths, deceleration lengths and storage lengths. DelDOT may remove crossovers when warranted by changes in surrounding land use or when necessary for traffic operation and safety.
- G. Turning movement diagrams for left and/or U-turn movements for the selected design vehicle(s) shall be provided for review. It may be necessary to widen the opposing shoulder to permit U-turn movements for the chosen design vehicle.

Figures 5.2.9.4-a thru 5.2.9.4-d provide examples for directional median crossovers providing left-in movements for WB-40 and WB-62 design vehicles and U-turn movements for passenger car vehicles from a divided roadway with varying median widths being measured from the median nose.

Figure 5.2.9.4-a Directional Median Crossover for WB-40 D.V. – Median Width  $\geq 4'$  to  $< 18'$

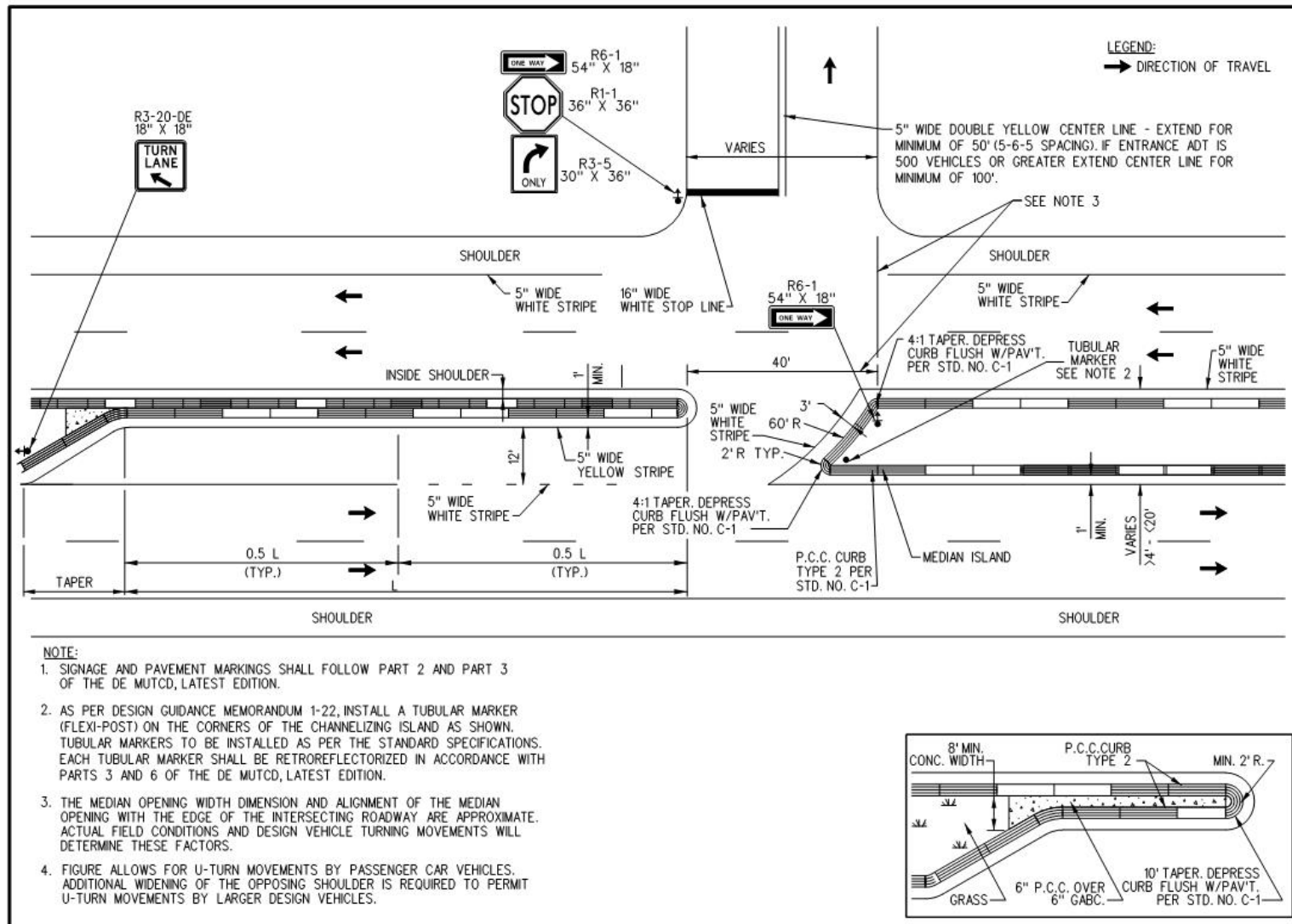


Figure 5.2.9.4-b Directional Median Crossover for WB-62 D.V. – Median Width  $\geq 4'$  to  $< 18'$

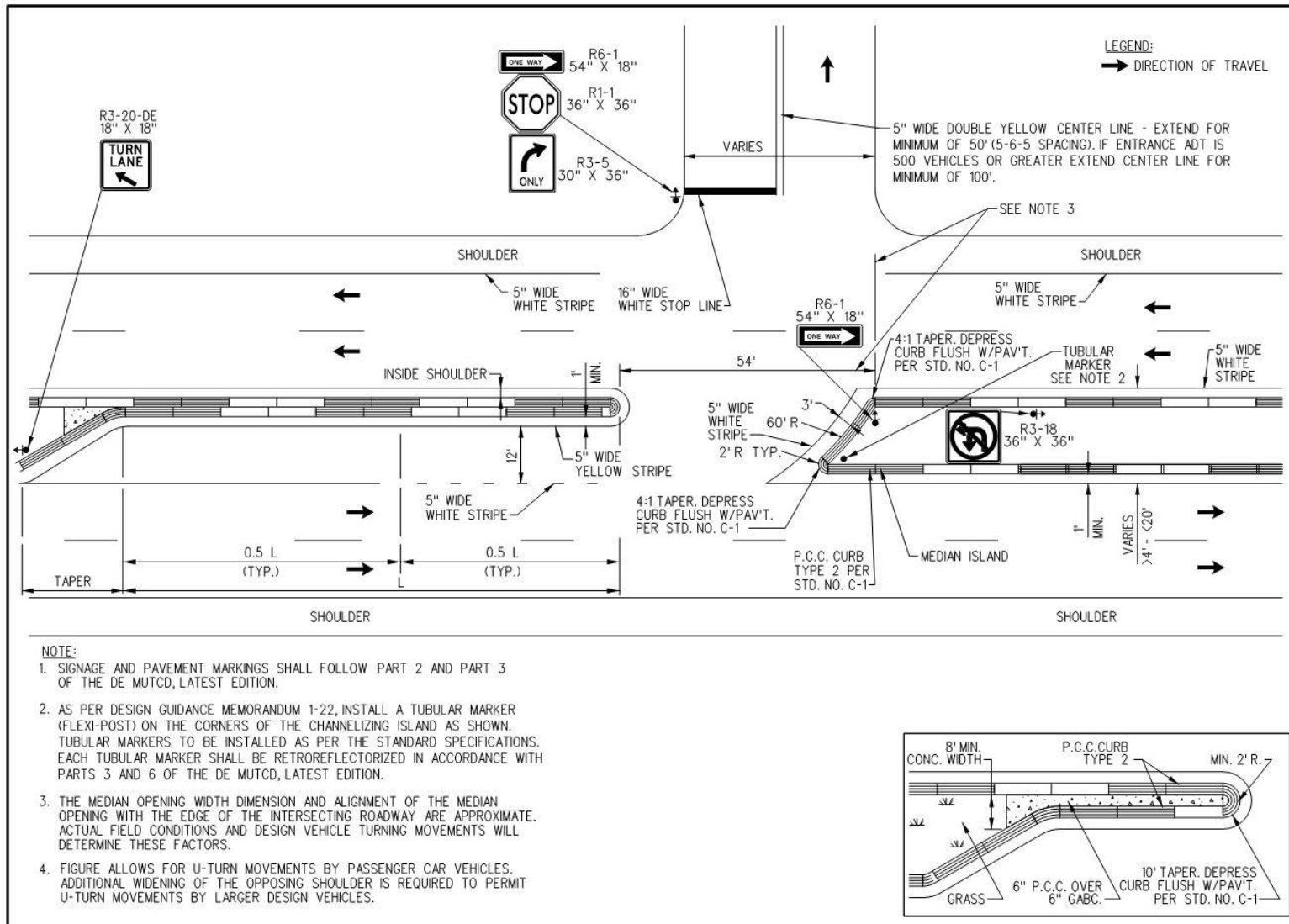


Figure 5.2.9.4-c Directional Median Crossover for WB-40 D.V. – Median Width  $\geq 18'$

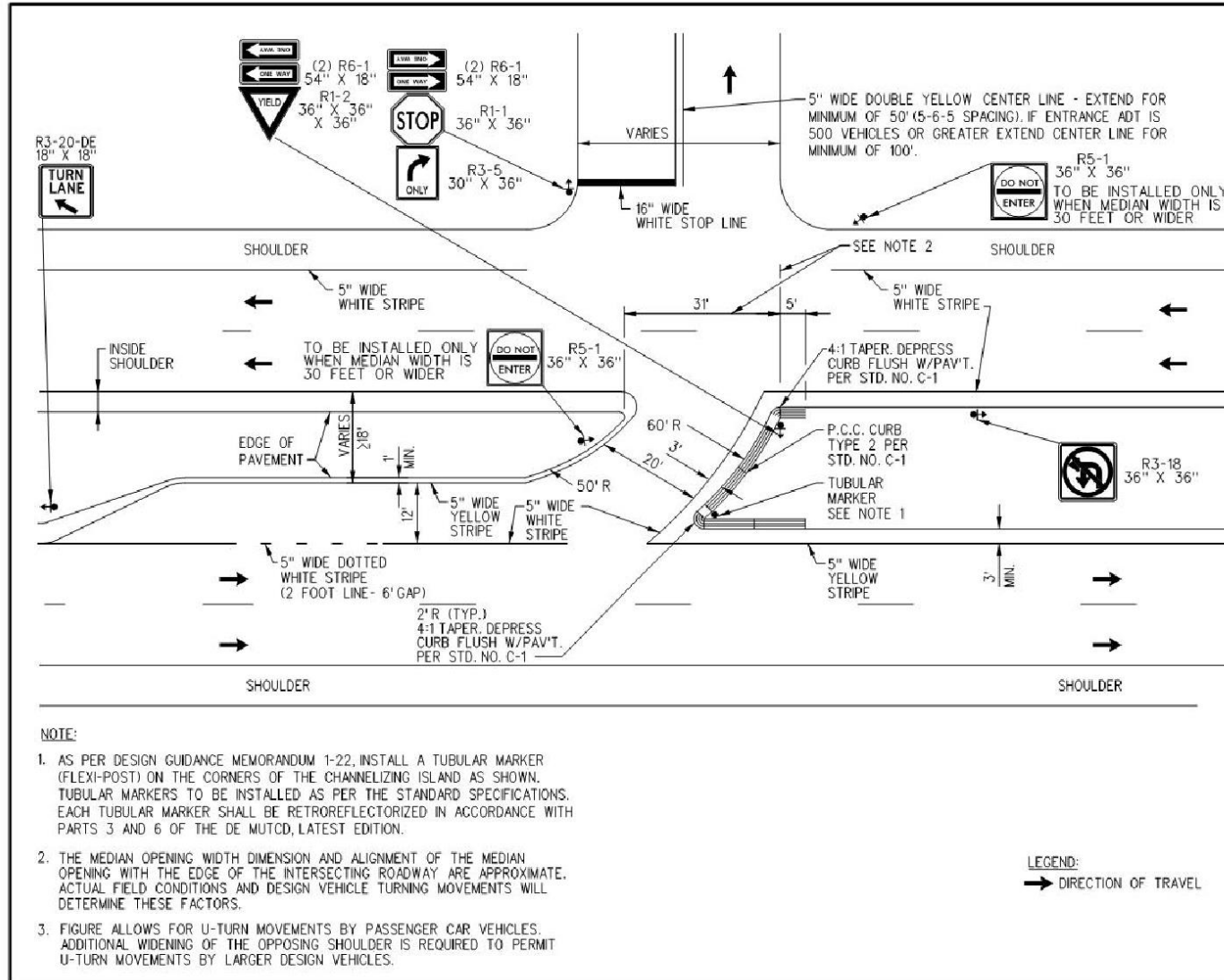
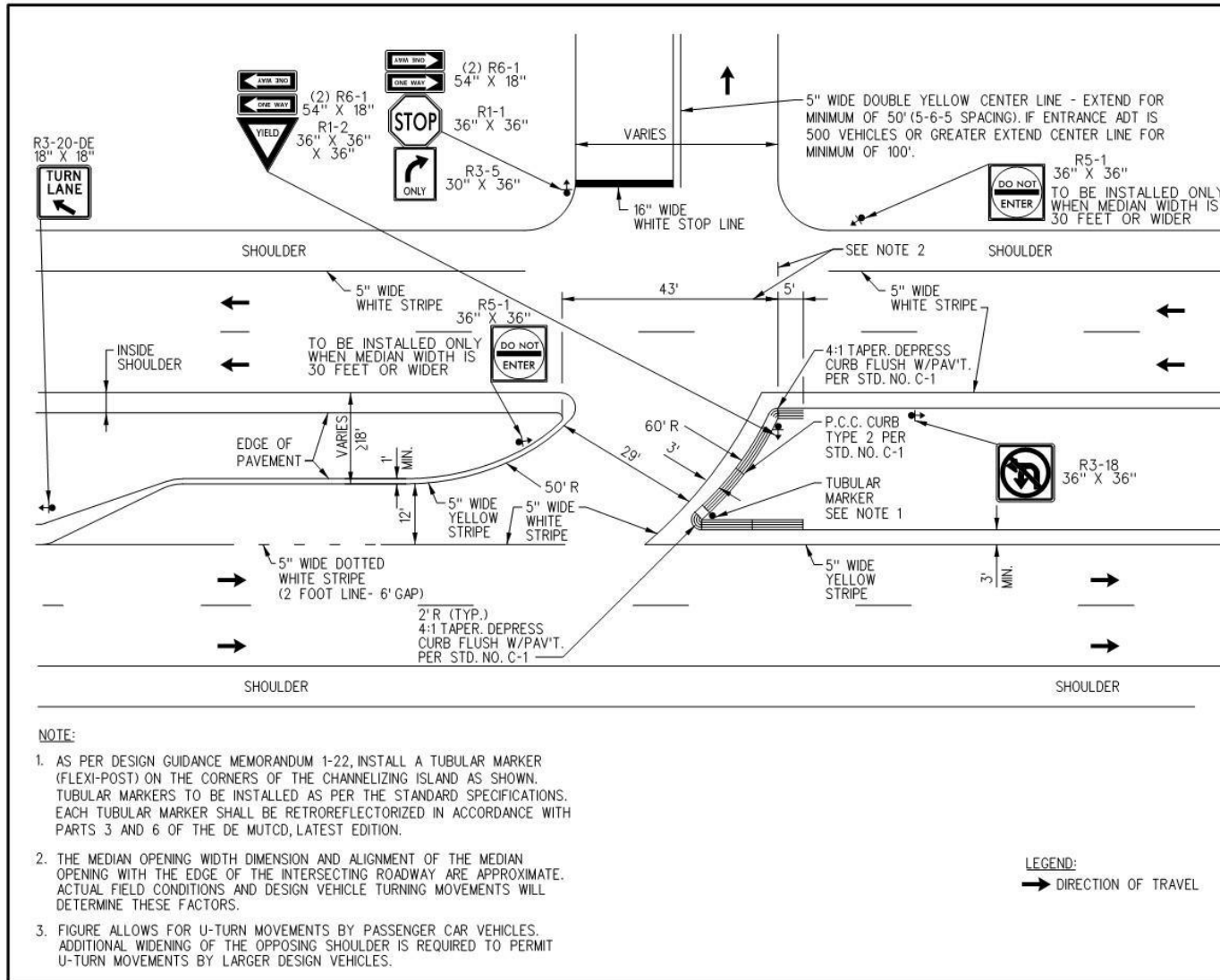


Figure 5.2.9.4-d Directional Median Crossover for WB-62 D.V. – Median Width  $\geq 18'$





## **5.2.10 Subdivision and Commercial Entrance Design Guidelines – Bike Lanes**

Suitable accommodations for bicyclists shall be required for all subdivision and commercial site plans. Additional guidance is available through DelDOT's *Complete Streets Policy* and other reference materials. All new roadways, except those where bicyclists shall be legally prohibited, shall be designed and constructed to encourage use of bicycles as a form of transportation. Unless access is specifically denied, some level of bicycle use can be anticipated on most roadways. Site entrance designs must accommodate bicycle traffic.

The design of a bike lane needs to include appropriate pavement markings and signing approaching and through intersections to reduce the number of conflicts. Guidance for signing and pavement marking of bike lanes is provided through regulations and standards such as the DE MUTCD and AASHTO's *Guide for the Development of Bicycle Facilities*.

A bike lane shall be delineated to indicate the separation from the motor vehicle travel lanes with a five-inch wide solid white line. Adequate pavement surface, bicycle-safe grate inlets, and safe railroad crossing shall be provided on roadways where bicycle lanes are being designated. Raised pavement markings and raised barriers can cause steering difficulties for bicyclists and shall not be used to delineate bicycle lanes.

## **5.3 PEDESTRIAN FACILITIES**

Pedestrian facilities shall meet the requirements of DelDOT's Shared Use Path and/or Sidewalk Process and Sidewalk Termination Policy as described in section 3.5.4.2 of this manual.

### **5.3.1 Pedestrian Facilities - Sidewalks**

Sidewalks are an integral part of DelDOT's infrastructure program and Complete Streets policy. They facilitate and encourage safe and convenient pedestrian travel within communities and among different land uses. They provide safe and reasonably direct access to public transportation and other alternative modes of transportation, thereby helping to alleviate vehicular traffic congestion and reduce emissions. They also reinforce the Americans with Disabilities Act (ADA) by increasing the access opportunity for mobility-impaired individuals. DelDOT requires sidewalks on both sides of subdivision streets.

All sidewalks and curb ramps must be ADA compliant.

#### **5.3.1.1 Placement**

In establishing the location of sidewalks, consideration must be given to drainage facilities, sideslopes, new traffic control and signing devices, intersection crossovers, striping, utility appurtenances, mailboxes with posts, and transit stops, in order to avoid conflicts in the design.

For new sidewalks, a minimum width of five feet, not including the width of the top of curb, is required. Wider sidewalks may be preferred or required by local ordinance depending upon the volume and nature of two-way pedestrian traffic. Narrower sidewalks may be allowed subject to consistency with ADA requirements, and surrounding roadside or geographic constraints. Sidewalks should be designed with a

1.5% cross slope and may not exceed 2%. A 6:1 maximum slope is required for 2 feet on both side of the sidewalk. Refer to standard detail no. M-3 for more guidance.

A buffer between the sidewalk and curb shall be considered. For increased user safety, sidewalks should be as far away from travel lanes as practical. Also, a buffer width of at least five feet between the edge of a sidewalk and the edge of pavement, parking lot, or traveled way is preferred. A five-foot wide strip improves safety, driver comfort, and provides an area for snow removal, utilities and mailbox posts. On uncurbed frontage roads, the buffer width should be 10' from the edge of pavement to the edge of sidewalk. If sod is used next to a sidewalk, the area adjacent to the sidewalk shall be graded to ensure that the sod is placed flush or just below the edge of sidewalk to avoid water ponding on the sidewalk.

### **5.3.1.2 Material**

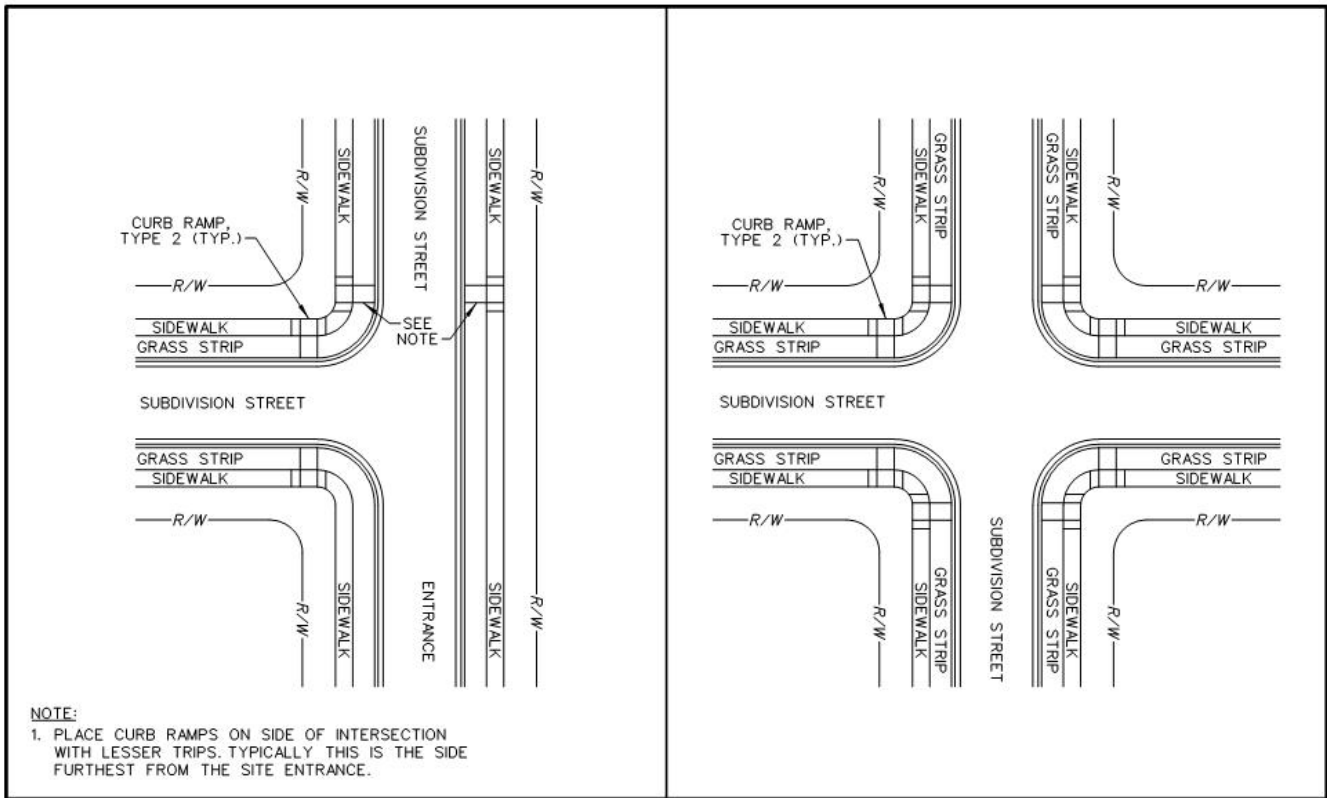
Standard material for any sidewalk or walkway is usually Portland Cement Concrete. However, sidewalk or walkway materials are not limited to Portland Cement Concrete. Upon approval, other materials may be used.

Minimum thickness can vary according to materials, but must be at least four inches for Portland Cement Concrete (PCC) on four inches of graded aggregate base course (GABC). A minimum thickness of six inches of PCC and six inches of GABC are required where sidewalks traverse entrances and driveways. Channelizing islands shall include a minimum thickness of eight inches of PCC and six inches of GABC.

### **5.3.1.3 Ramps**

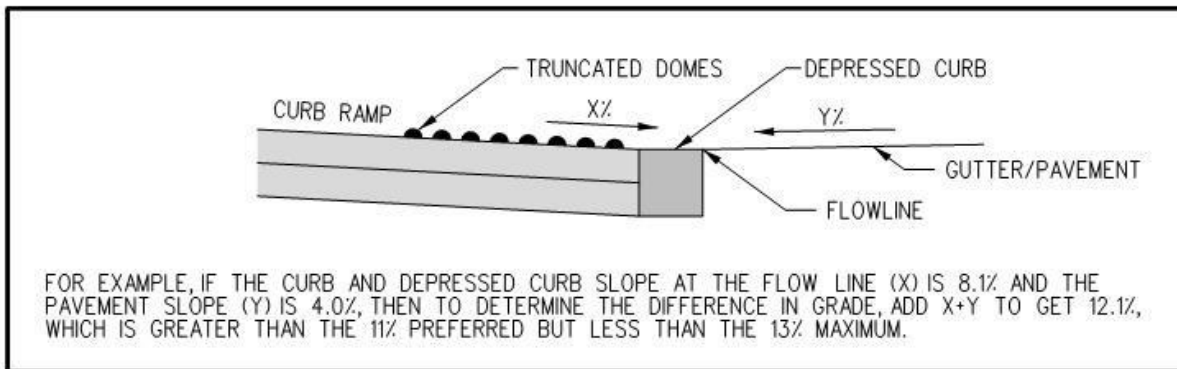
At intersections, paired perpendicular curb ramps are preferred because they provide an accessible route to enter the crosswalk perpendicular to the travel lane. 4-way intersections should have a total of 4 crossings, whenever possible, with two ramps on each corner. 3-way "T" intersections should have a total of 2 crossings, with one for each road. Where feasible, drainage structures shall be placed to allow for two ramps on each corner and perpendicular crossings. Single ramps at the intersection radius may only be used in exceptional circumstances at entrances or offsite intersection improvements such as retro-fit improvements, where the existing infrastructure or field conditions prohibit two ramps to be installed. In any case, a single ramp on a corner shall not be placed if it is a risk to the user. See Figure 5.3.1.3-a for suggested curb ramp locations at intersections of subdivision streets.

**Figure 5.3.1.3-a Intersection Curb Ramp Detail  
(Not to Scale)**



Curb ramps shall be designed in accordance with DelDOT’s standard detail no. C-2. A 24 inch wide strip of detectable warnings (truncated domes) shall be placed along the full width of the ramp at the transition to the street. It is preferred that the difference in grade where a ramp ties into a gutter or pavement be less than 11 percent but in no cases shall it be greater than 13 percent as shown in Figure 5.3.1.3-b. Sidewalks crossing driveway entrances should be designed per DelDOT’s standard detail no. C-3. For more guidance on sidewalks and curb ramps refer to [Chapter 10 Miscellaneous Design](#) in DelDOT’s *Road Design Manual*.

**Figure 5.3.1.3-b Maximum Difference in Grade for all Curb Ramp Types**



### **5.3.2 Pedestrian Facilities - Shared Use Path**

A shared use path is a facility that is physically separated from the roadway and intended for exclusive use of modes other than motorized vehicles. Figure 5.3.2-a shows a layout for a typical two-way shared use path.

Guidance for signing and pavement marking of shared use paths is shown in the DE MUTCD and various AASHTO publications.

#### **5.3.2.1 Design Criteria**

Refer to applicable guidelines and standards such as those available in the DelDOT *Road Design Manual* and AASHTO's *Guide for the Development of Bicycle Facilities* for additional design criteria that should be used for shared use paths.

A shared use path should be adequately separated from nearby roadways to prevent operational problems that inconvenience path users. The desirable separation of a shared use path from a roadway is ten feet. The minimum separation of a shared use path from the pavement is five feet. When this minimum is not possible, a separate facility for bicyclists such as a shoulder or a treatment such as rumble strips on the edge of the adjacent roadway should be provided. If sod is used next to a shared use path, the area adjacent to the shared use path shall be graded to ensure that the sod is placed flush or just below the edge of sidewalk to avoid water ponding on the shared use path.

Shared use paths should be at least 10 feet wide. In high use areas it is recommended to increase the width to 12 feet. Paths should be designed with a 1.5% cross slope and may not exceed 2%.

#### **5.3.2.2 Intersections**

Intersections with roadways are important safety considerations in shared use path design. There are three basic types of path-roadway intersections: mid-block, adjacent path and complex. If alternate locations are available, the one with the most favorable intersection conditions should be selected.

The use of mid-block crossings is generally discouraged. However, if the use of a mid-block crossing is the only option, then a neck-down of the roadway width or curb extension should be considered to minimize the length of the crossing.

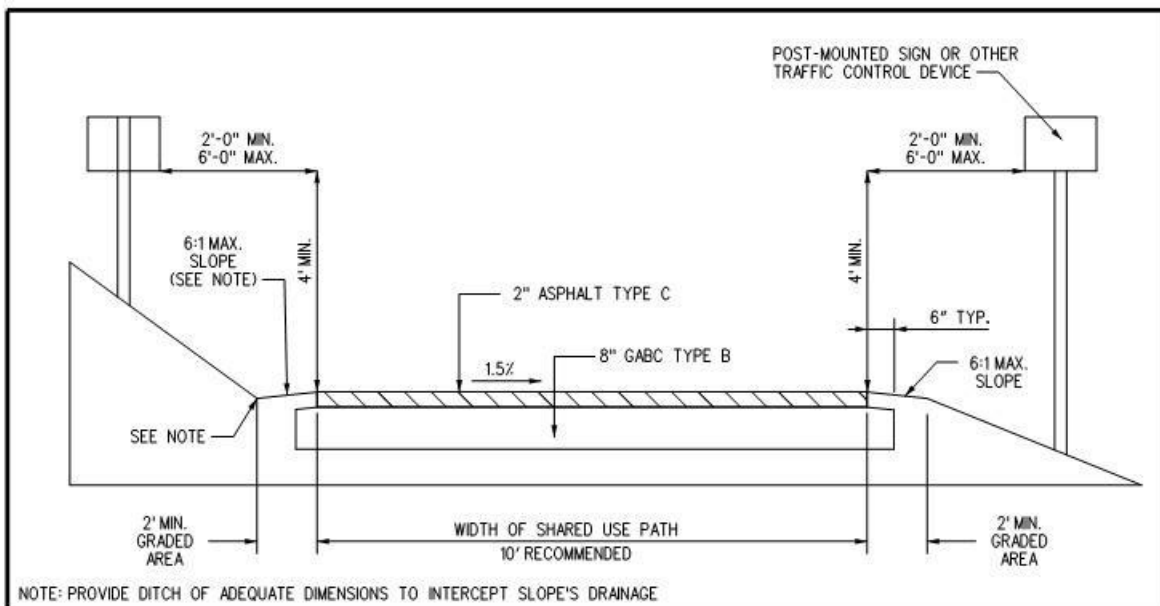
Adjacent path intersections occur when the path is parallel to a roadway and it crosses a driveway or other intersecting roadway such as a T-intersection or a simple four-legged intersection. In designing this type of crossing, it is important to keep the location close to the intersection. This allows the motorist and path user to recognize they are a part of the traffic mix and to be prepared to react accordingly

Complex intersections such as grade separated interchanges are site-specific and need to be designed to meet the unique issues associated with them.

When shared use paths terminate at existing roads, it is important to integrate the path into the existing system of roadways. Care should be taken to properly design the terminals to transition the traffic into a safe merging or diverging situation. Appropriate signing is required per the DE MUTCD to warn and direct both bicyclists and motorists regarding these transition areas. Shared use path intersections and approaches should be on relatively flat grades. Stopping sight distances at intersections should be checked and adequate warning should be given to permit bicyclists to stop before reaching the intersection, especially on downgrades.

Curb ramps at intersections should be the same width as the shared use path. Curb ramps shall be ADA compliant and should be designed per DelDOT standard details C-2 and M-3.

**Figure 5.3.2.2-a Cross Section – Two Way Shared Use Path**  
(Not to Scale)



### 5.3.3 Transit Stop Design

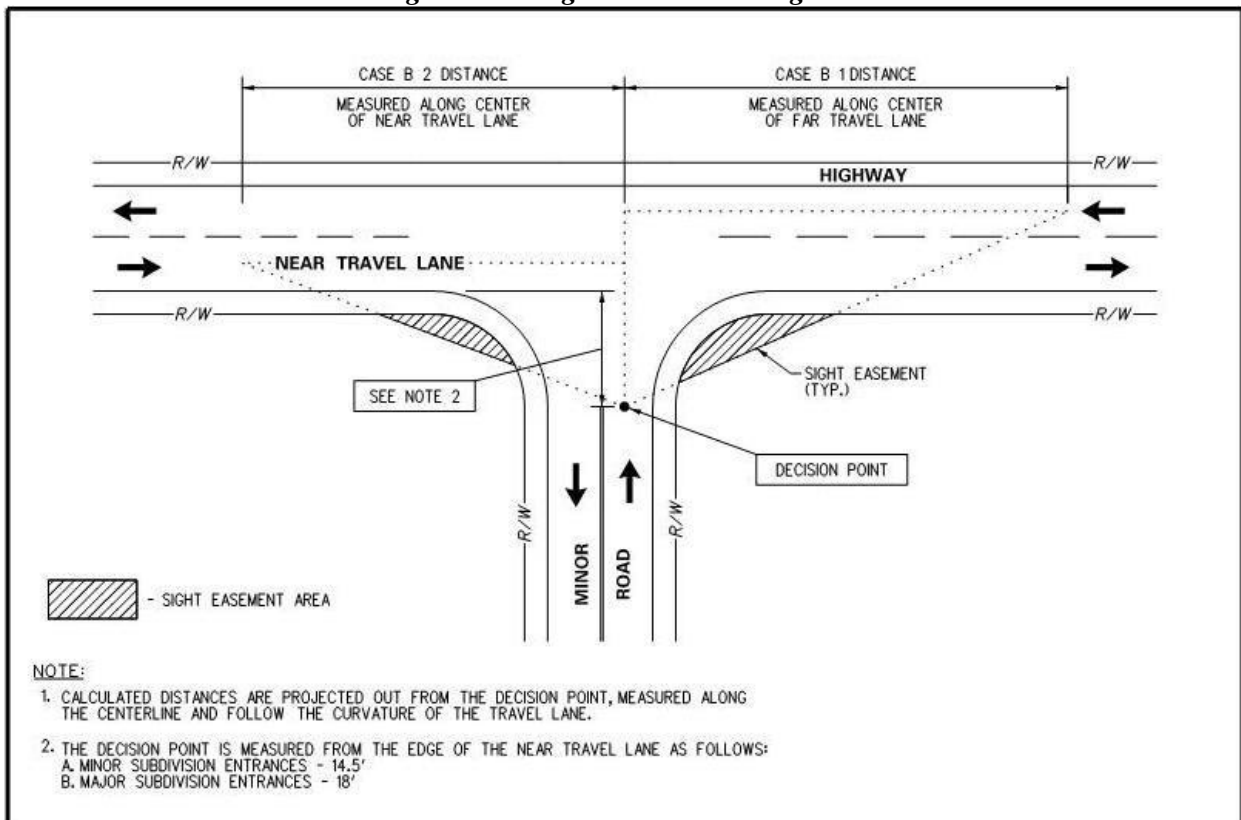
DTC has established policy and design guidelines that should be used for designing bus stops and other transit-related facilities. As part of the project development process, highways and corridors served by transit will be identified and appropriate facilities will be included in the project. For specifics, the designer should refer to the applicable guidelines and standards, such as: DTC's "Bus Stop and Passenger Facilities Standards"; Sections 10.10 *Bus Stops* and 10.11 *Park-and-Ride Lots* of *DelDOT's Road Design Manual*; and *DelDOT's Standard Construction Details*. If it is determined that a transit facility is necessary, the facilities are to be installed in locations which maximize pedestrian safety while minimizing operation conflicts within auxiliary lanes and channelizing islands.

### 5.4 SIGHT DISTANCE

When an entrance is provided to a State-maintained roadway, the area adjacent to the right-of-way shall be clear and free of obstructions. When approaching an intersection, a driver should have an unobstructed view of the intersecting roadway and the ability to view any approaching vehicles at the intersection. The sight distances shall be determined in accordance with the requirements of this section. Projects shall demonstrate compliance by completing the Intersection Sight Distance worksheet available online at <http://www.deldot.gov/Business/subdivision> Forms>.

- A. The entrance location and design shall provide a clear line of sight for the driver of a vehicle preparing to enter the roadway and should be designed in accordance with applicable guidelines and standards such as DelDOT's policies and AASHTO's location and design standards.
- B. The departure sight triangle (see Figure 5.4-a) shall be used at entrances where a stopped driver on a minor road approach (entrance) attempts to depart from the intersection and enter or cross a major road. Calculated distance from the center of the near travel lane to 18 feet from the edge of through lane (see note 2.b in Figure 5.4-a) should be used as the decision point in departure sight triangle. For minor subdivision plans, the calculated distance can be a minimum of 14.5 feet from the edge of the near through lane.
- C. Any marquee sign located in conformance with the Outdoor Advertising requirements must be placed to maintain the required sight distance.
- D. If the sight triangle established in accordance with the standards of this chapter is outside the existing of dedicated right-of-way on the subject parcel, then a sight easement shall be established to maintain the required sight distance as shown on Figure 5.4-a. If the sight triangle is outside the existing of dedicated right-of-way on an adjacent parcel, then a sight easement should be obtained by the applicant to maintain the required sight distance. If the applicant is unable to obtain the easement, then development may be limited to eliminate the need for the easement on the adjacent parcel.
- E. At entrances, the sight triangle shall be maintained so as to be free of plantings or anything that could obstruct the sight distance.
- F. Within the streets of a subdivision the placement of shrubbery or other visual barriers is prohibited within the triangular area formed by the intersection of two curb lines and a line joining the respective points on each of these lines at a distance of 30 feet from the point of intersection. These triangular areas shall be designated on the record plans as sight triangle easements. DelDOT shall have full authority to maintain or require them to be maintained in order to keep the required sight distance. Fire hydrants shall not be considered visual barriers or hazardous obstacles.

Figure 5.4-a Sight Distance Triangles



## 5.5 TYPICAL SECTIONS

Typical sections shall be designed in accordance with the requirements of this section, and shall include all necessary features as specified in Chapter 4.

- A. Subdivision Streets – Typical sections are required for subdivision streets and shall define the roadway width, cross slopes, and stormwater runoff accommodations (curbs or ditches/sideslopes).
- B. State-maintained Roadways (frontage roads) – If an entrance requires any modification or improvement on the State-maintained roadway, a typical section shall be required. The typical section shall show the existing and proposed pavement widths and sideslopes and ditches as outlined in this section.

### 5.5.1 Typical Sections - Pavement Widths

- A. Subdivision Streets – Pavement widths shall be designed in accordance with appropriate street classification (refer to Figure 5.2.4-b) and drainage design. See Figures 5.5.1-a through 5.5.1-d for typical cross sections.
- B. State-maintained Roadways (frontage roads) – The width of deceleration lanes associated with the entrance design shall be a minimum of ten feet in width excluding the curb's gutter pan width. If accommodations are required for bikes on the facility, the width of the auxiliary lane shall be increased to a minimum width of 15 feet. The lateral offset from the roadway centerline of a

deceleration lane shall accommodate a minimum 11-foot wide through lane. For example, if an existing local roadway is 20 feet wide, then the through lane will be widened to 11 feet for the length of the deceleration lane.

### **5.5.2 Typical Sections - Curbs**

Curbing may be used to accommodate stormwater runoff. Refer to the DeIDOT *Standard Construction Details* for curb types. Any proposed modification to the DeIDOT standard curb types shall be shown with a detail on the construction plan and is subject to DeIDOT approval.

A minimum of six inches of GABC type B shall be placed under curbs proposed in subdivisions and four inches for all curbs proposed elsewhere and shall extend six inches beyond the back of curb.

Curbs shall be used for all entrances and islands located in the following areas:

- A. Subdivision Streets and Industrial Streets – Use curb types shown on Figures 5.5.2-a through 5.5.2-d.
- B. State-maintained Roadways (frontage roads)
  - 1. On all collectors and arterials as shown on DeIDOT’s Functional Classification Map
  - 2. In municipalities and urban areas
  - 3. Where the existing highway is curbed
  - 4. Where necessary to control access
  - 5. When the design velocity of an open ditch section exceeds 3 ft./sec., soil reinforcement or a curb and gutter system should be considered. See [Chapter 6 Drainage and Stormwater Management](#) of DeIDOT’s RDM for more guidance.

The type of curb to be used must be shown on the entrance drawing. Where the roadway is curbed, any curb returns of the driveway shall match the existing curb line. In rural areas curbing may be omitted if access and drainage can be effectively controlled by a roadside ditch or other means as determined by DeIDOT.

No portable curb channelization shall be permitted on the entrance facility. Curbing for channelization should be constructed using a mountable-type curbing having a sloping face such as type 2 PCC curb. Special details must be included in the construction plans. Channelization may be poured monolithically if approved by DeIDOT.

If drainage runoff will be conveyed along the edge of a curbed frontage road, then a curb and gutter type shall be used. Curbs proposed on roadways with a design speed of 50 mph or greater shall be mountable and be limited to a 4 inch vertical face. Roadways with a design speed of 45 mph or less should use an 8 inch barrier curb.

Where 8 inch height curb is allowable, it must include a throat adjacent to drainage inlets. Refer to Section 5.7 for more information.

Where guardrail is proposed, a maximum curb height of 4” is allowed and shall be positioned under the w-beam railing as shown on standard detail no. B-1. Within the limits of the end treatment and throughout the length of the taper grading, a maximum curb height of 2” is allowed as shown on standard detail no. B-2.



Figure 5.5.2-a Subdivision Street Typical Section (With Curb) - Types I and II  
(Not to Scale)

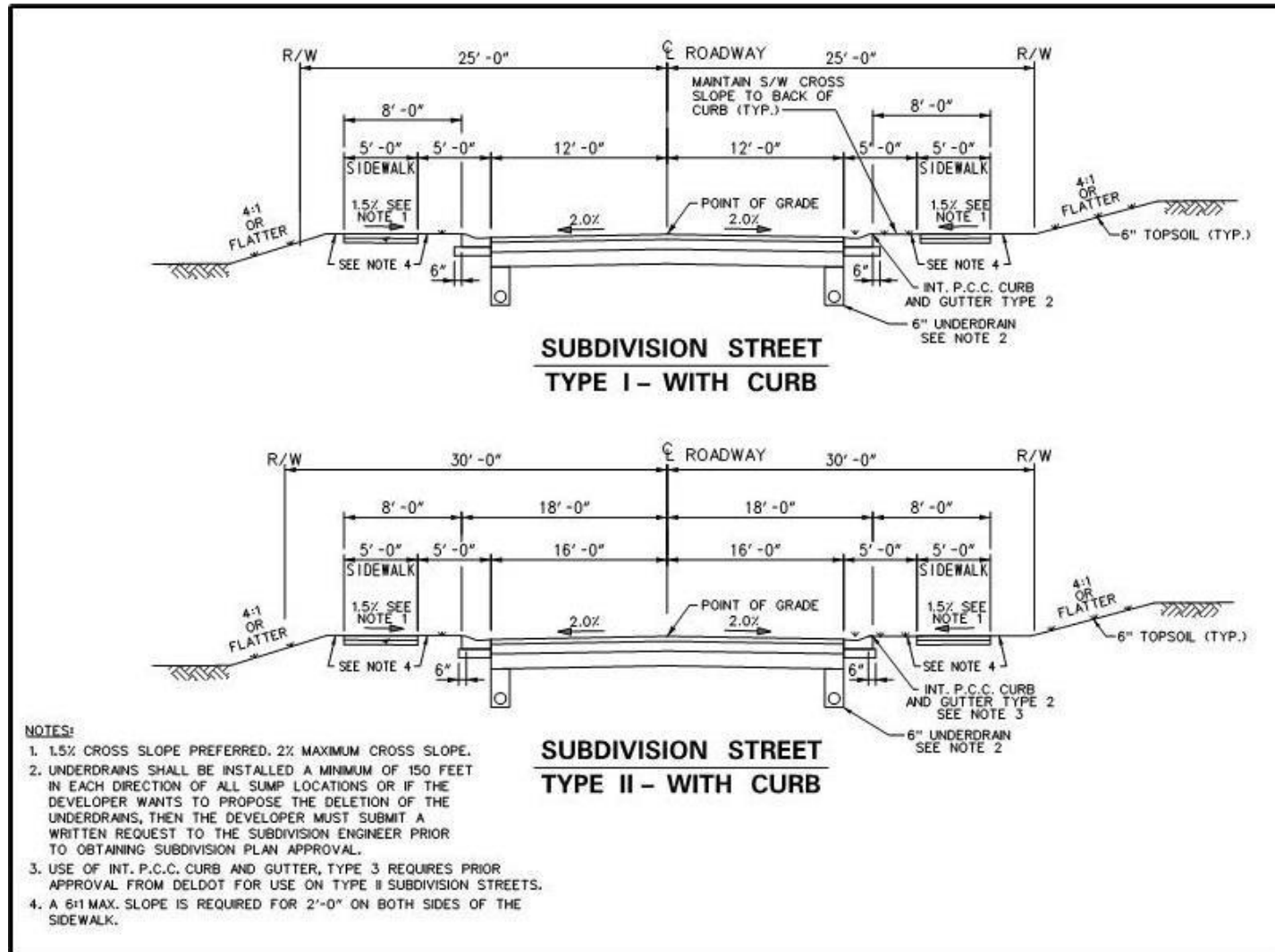
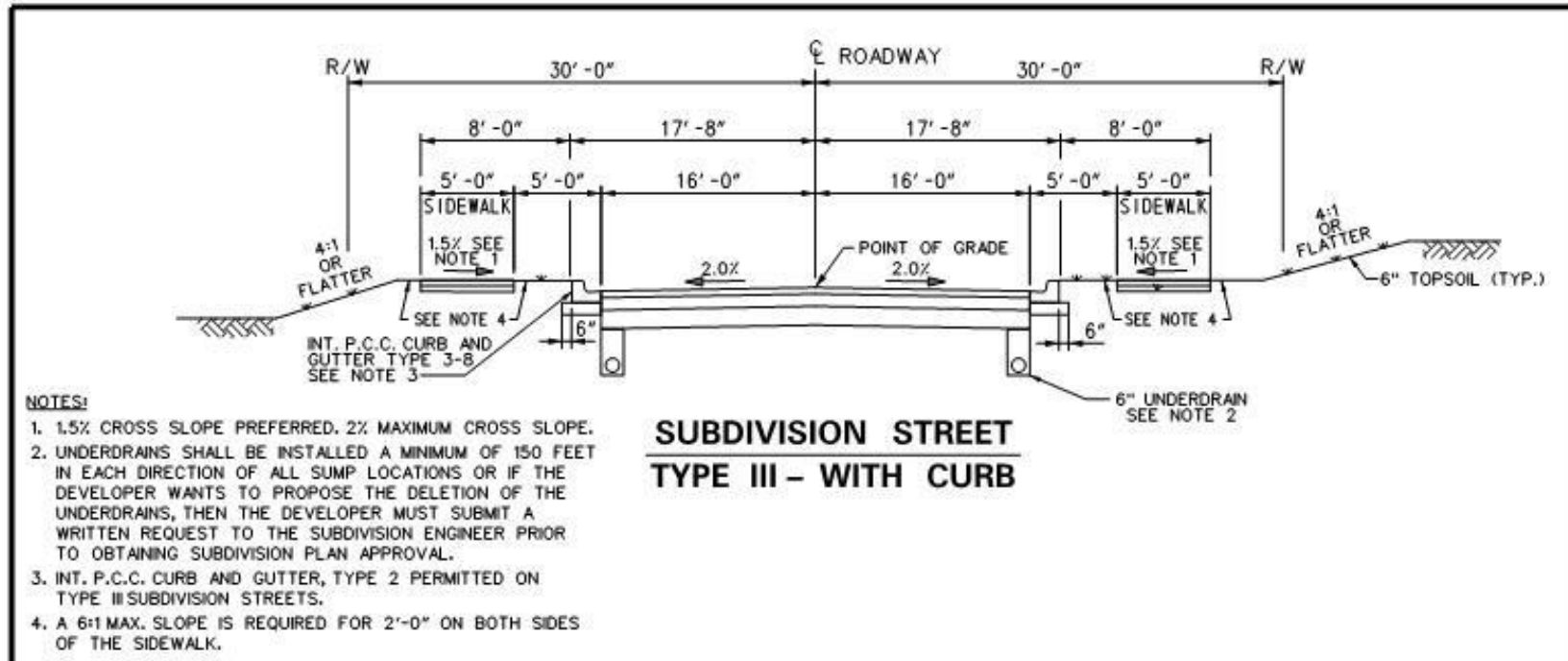


Figure 5.5.2-b Subdivision Street Typical Section (With Curb) - Type III  
(Not to Scale)



**Figure 5.5.2-c Subdivision Street Typical Section (Without Curb)**  
(Not to Scale)

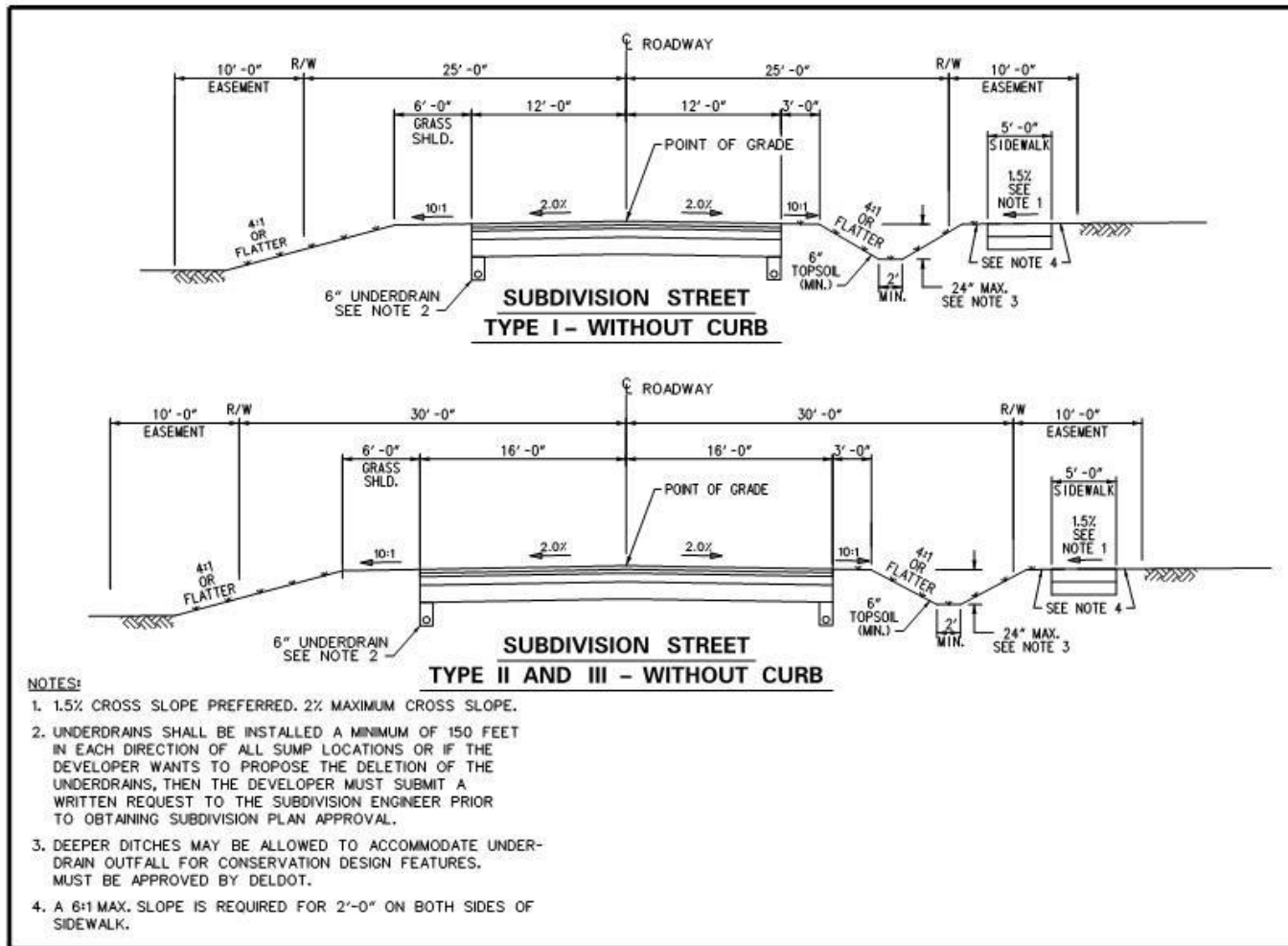
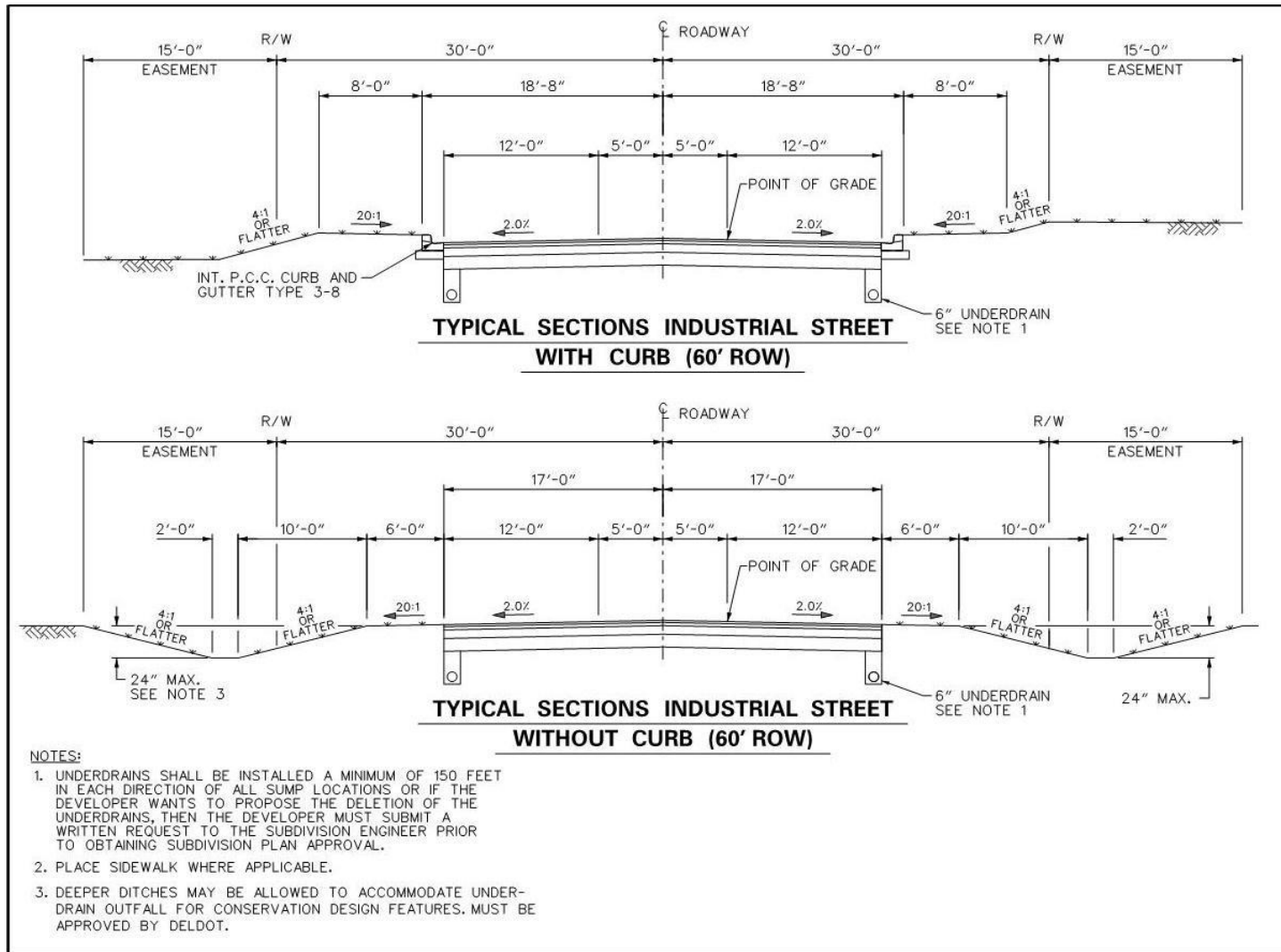


Figure 5.5.2-d Industrial Streets Typical Section (With and Without Curb)

(Not to Scale)



### 5.5.3 Typical Sections - Ditches and Sideslopes

- A. Subdivision Streets – The ditch and sideslope sections for subdivision streets shall meet the minimum slopes as shown on Figures 5.5.1-a through 5.5.1-c.

The minimum depth of a ditch has been established to provide for sub-surface drainage. This minimum depth must be maintained throughout the subdivision. This depth can vary if a swale over a closed drainage system is used.

To minimize rutting and erosion of the roadside due to on-street parking, the site plan shall be developed to allow for vehicles to be stored in the driveway beyond the right-of-way. A note on the record plan shall state this requirement.

A six-foot grass shoulder shall be treated with an approved turf reinforcement mat to protect the edge of the pavement and to minimize the potential for soil erosion. In addition, design stormwater velocities within the open ditch section should be limited to a maximum of three feet per second.

- B. State-Maintained Roadways – applicable guidelines and standards such as: DelDOT's *Road Design Manual*, AASHTO's *Roadside Design Guide* or **NAS** shall be used when designing sideslopes and ditch sections associated with any entrance improvements.

If pipes are used at site entrances in conjunction with an open drainage system, the longitudinal slope from the entrance pavement to the top of the pipe shall be six-to-one (6:1).

### 5.5.4 Typical Sections - Underdrains

The long-term presence of water within the pavement structure is largely responsible, directly and indirectly, for many of the distress and performance problems in pavement systems. The addition of longitudinal perforated underdrains is a feasible and cost-effective option for removing water from the road bed. Underdrains are a system of perforated pipes that collect and transmit the water to an outfall site.

Underdrains shall be installed at a minimum length of 150' in each direction from any sump location on all subdivision streets. Based on field conditions encountered while performing reviews or during construction, additional underdrain may need to be installed, at DelDOT's direction, along portions of streets affected by conditions such as the following: segments that have a longitudinal slope of 2% or flatter, where high water-table issues are observed, where the road is placed in a deep-cut versus original existing grade, or where poor soils are present. The typical section shall show the location of the underdrain in accordance with Figures 5.5.1-a through 5.5.1-d. Refer to DelDOT's *Standard Construction Details* for dimensions and materials.

If the developer can demonstrate underdrains are not warranted, through an engineering analysis, signed and sealed by a Professional Engineer registered in Delaware, DelDOT shall grant a waiver on the required underdrains referenced above. All costs associated with the developer's engineering analysis shall be at their cost. DelDOT will not provide any reimbursement.

The engineering analysis shall include the following:

- A. Average water table for the last 25 years for the area in question
- B. Soil boring or test pit information including characteristics and relevant AASHTO classification to a minimum depth of ten feet

- C. Infiltration rate (tested in accordance with ASTM D5126-90 “Comparison of Field Methods for Determining Hydraulic Conductivity in the Vadose Zone”)
- D. Construction plan showing the inlet and boring locations
- E. Topography maps showing proposed road stationing and boring locations for the area in question
- F. USGS wetland delineation maps

Upon submission of all the information listed above, DelDOT will review the analysis and provide a written response to the developer’s request for non-utilization of underdrains.

### **5.5.5 Typical Sections - Clear Zone**

The clear zone as defined in AASHTO’s *Roadside Design Guide* (RDG) includes “the total roadside border area, starting at the edge of the traveled way, available for safe use by errant vehicles. This area may consist of a shoulder, a recoverable slope, a non-recoverable slope, and/or a clear run-out area. The desired width is dependent upon the traffic volumes and speeds and on the roadside geometry.”

Adequate lateral clearance between the edges of traffic lanes and roadside obstructions has been shown to be a very important safety factor. Vehicles leaving the roadway should have a reasonable opportunity to recover control and return to the roadway without overturning or colliding with roadside obstacles such as trees, poles, headwalls, or other large objects. The combination of a relatively flat slope and an obstacle-free roadside within the prescribed clear zone helps this situation.

The determination of a clear zone is a function of speed, volume, curvature, and embankment slope. Chapter 3 of AASHTO’s RDG or other **NAS** should be used for determining clear zone widths. When deviations from the clear zone criteria are proposed, the engineer shall prepare and submit justification for review and approval by the Subdivision Engineer. Justification documentation may include but not be limited to: tables and excerpts from Chapter 3 of AASHTO’s RDG or other **NAS**; construction plan views; and typical sections of the area. Regardless of the required clear zone width or ability to implement that width fully, a minimum horizontal clearance of 10 feet from the edge of travel lane and 5 feet from the edge of pavement shall be provided along rural collectors and rural local roads.

Some roadside appurtenances, such as guardrails, breakaway light poles and signs using breakaway posts, may be part of a proposed development. If they are located within the specified clear zone they must be crashworthy in accordance with applicable guidelines and standards such as: NCHRP Report 350 Test Level III Criteria, AASHTO’s *Manual for Assessing Safety Hardware* (MASH) or **NAS**. When used, they should also be placed in the safest available location.

For guardrails within the clear zone, it is desirable to maintain a minimum 2 foot lateral offset between the outer edge of the usable shoulder and the face of the rail. Guardrails in and of themselves present a hazard and only should be used as a last resort if objects cannot be moved or the required sideslopes cannot be provided. At bridge approaches, guardrails should either match the width of the bridge or taper to meet the bridge rail. Refer to DelDOT’s *Standard Construction Details* for more information on guardrail types and end treatments.

### **5.5.6 Typical Sections – Lateral Offset**

For arterials and other non-controlled access facilities in an urban environment, however, rights-of-way often are extremely limited and, in many cases, establishing a clear zone using guidance in Chapter 3 of

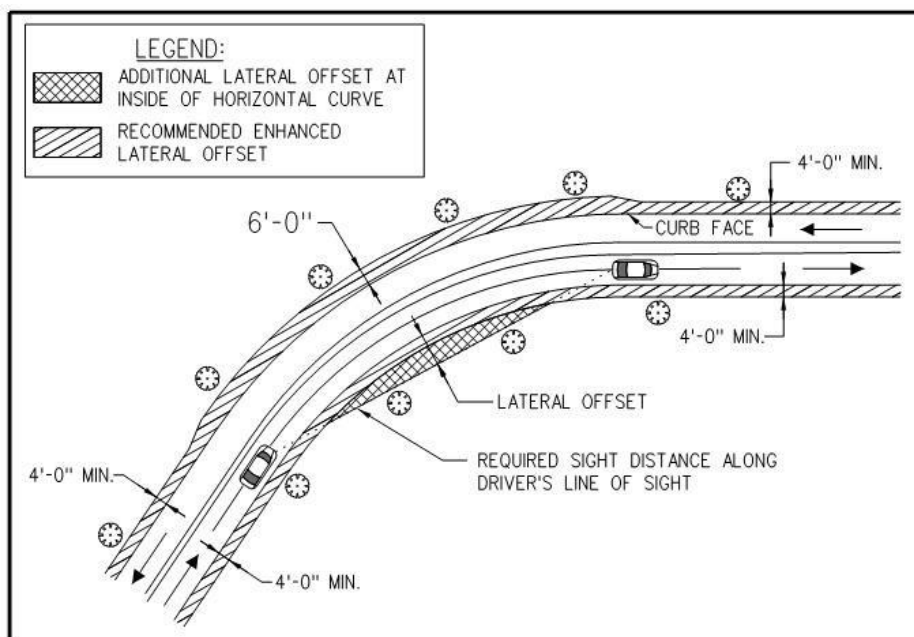
DelDOT's RDM is not practical. These urban environments are characterized by sidewalks beginning at the back of curb, enclosed drainage, numerous fixed objects (ex: signs, utility poles, fire hydrants, etc.) and frequent traffic stops. These environments typically have lower operating speeds and, in many instances, on-street parking. In these environments, a lateral offset to vertical obstructions, including breakaway devices, may be used to accommodate motorists operating on the highway.

The lateral offset value of 1.5 ft. has been considered a minimum lateral distance for placing the edge of objects from the face of curb. The minimum lateral offset was never intended to represent an acceptable safety design criteria, though sometimes it has been misinterpreted as such. In a constrained urban environment, there is still a need to position rigid objects as far away from the active traveled way as possible.

A few general guidelines have been provided below for lateral offsets, but, chapter 10, *Roadside Safety in Urban or Restricted Environments*, of the 2011 AASHTO RDG discusses in detail the various applications for lateral offsets. Please refer to applicable guidelines and standards such as those found in AASHTO's RDG to help determine the appropriate lateral offset(s) for your site-specific location.

- A. Where curb is used, the lateral offset is measured from the face of the curb.
- B. An enhanced lateral offset of 4 ft. to 6 ft. to obstructions is a more appropriate guide for these (urban or restricted) environments, and is recommended along roadway tangents and insides of curves. Note: Along the inside of curves, a lateral offset should be provided that keeps the driver's line of sight clear, to provide the required stopping distance. An enhanced lateral offset of 6 ft. is recommended at intersections and along outsides of curves. Refer to Figure 5.5.6-a.

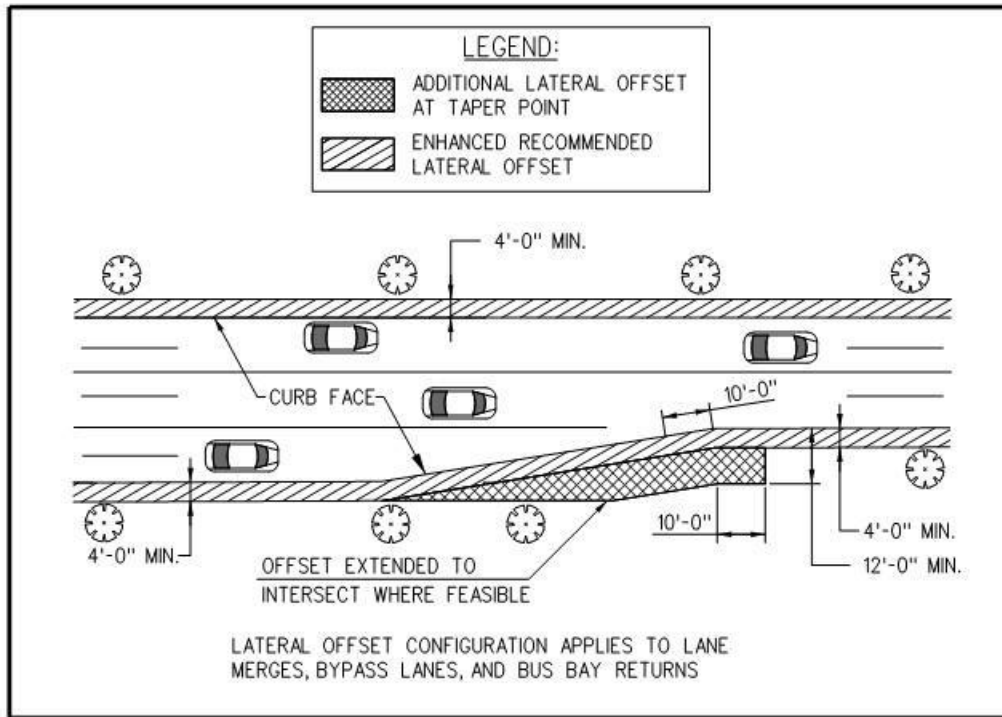
**Figure 5.5.6-a Lateral Offset Widths**



- C. Where curb is NOT present, lateral offsets of 8 ft. are recommended along roadway tangents and insides of curves when clear zone widths cannot be achieved.
- D. Where curb is NOT present, lateral offsets of 12 ft. are recommended along outsides of curves when clear zone widths cannot be achieved.

- E. At lane merge points, an enhanced lateral offset of 12 ft. is recommended in the immediate vicinity of the taper point from the lane merge curb face as shown in Figure 5.5.6-b. (See Figure 10-2 of the RDG for a detailed explanation of this enhanced lateral offset.

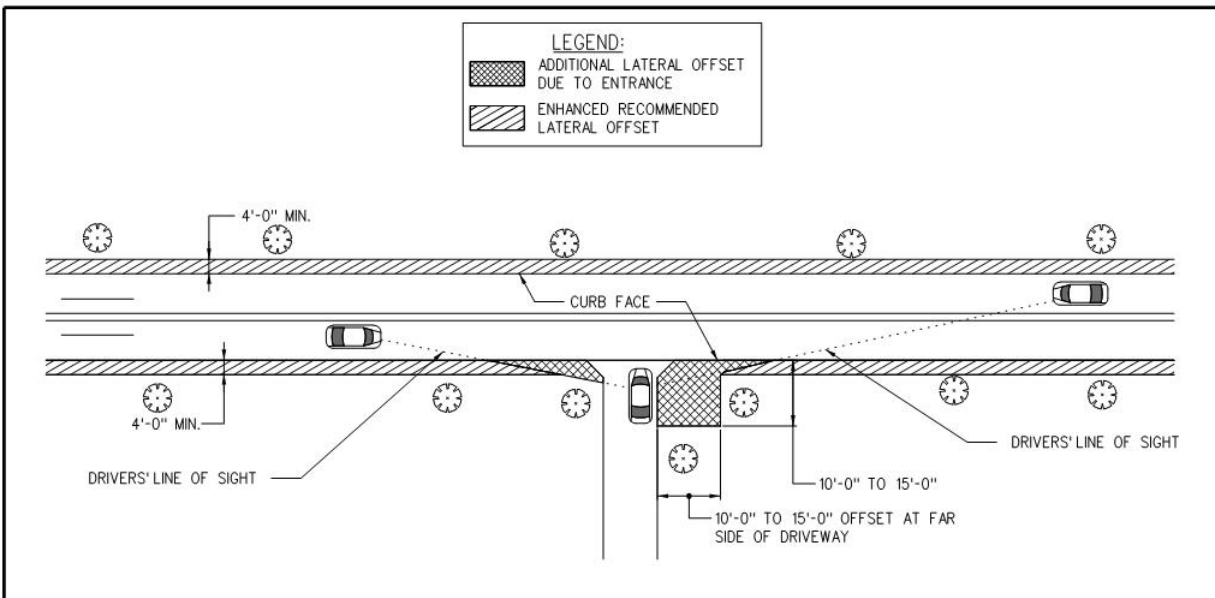
**Figure 5.5.6-b Lateral Offsets at Merge Points**



- F. At driveways a lateral offset of 10 to 15 ft. beyond the edge of the driveway should be considered to reduce the potential for a fixed-object collision in this high crash location as shown in Figure 5.5.6-c.



**Figure 5.5.6-c Lateral Offsets at Entrances**



## 5.6 PAVEMENT SECTIONS

Pavement sections are to be designed based on the ADT utilizing the planned roadway and the existing subsurface conditions. Acceptable pavement sections are to be designed based on assuming poor soils. If the applicant wishes to propose pavement sections based upon anything other than poor soils, soil testing may be performed, at no cost to DelDOT, by an accredited lab with DelDOT supervision of testing. This request shall be made prior to preliminary plan submission. The pavement sections listed in Figures 5.6.1-a and 5.6.2-a are designed to meet the required Structural Numbers (SN) and meet the following conditions/criteria:

- A. Bituminous Concrete (Asphalt) pavement may only be placed directly over GABC, never placed directly over select borrow or subgrade.
- B. Undisturbed sub-grade and/or select borrow cannot be counted in Structural Number calculations.

The binder grade and gyrations of mix for bituminous concrete (asphalt) pavements will be specified on a project basis during the review process and must be indicated on the plans.

Materials placed for construction of roadways in subdivisions, entrances, and industrial roadways must not be constructed in lifts that violate DelDOT's minimum and maximum lift thickness. The allowable lift thickness and structural values for materials used are shown in Figure 5.6-a.

Figure 5.6-a Material Properties

	Lift Thickness		SN Contribution Per Inch
	Minimum	Maximum	
Bituminous Concrete (Asphalt) Pavement Type C	1 ¼"	2"	0.4
Bituminous Concrete (Asphalt) Pavement Type B	2 ¼"	4"	0.4
Bituminous Concrete Base Course (BCBC)	3"	6"	0.32
GABC	4"	8"	0.14

### 5.6.1 Pavement Sections - Subdivision Streets

All subdivision streets and entrances shall be paved with bituminous asphalt concrete or Portland cement concrete surface. Pavement sections for internal subdivision streets are to be built to serve the traffic generated from the development upon completion, including all construction related traffic of the development. Should additional development phases be planned that will be connected to the portion of the development under construction, the pavement section for the street shall be such that it will support both the phase under construction and the future phases. The surface of the Type B bituminous concrete (asphalt) pavement shall be free of defects such as potholes, alligator cracking or rutting prior to the placement of the Type C bituminous concrete (asphalt) lift. Figure 5.6.1-a shows examples of pavement sections acceptable for use on internal subdivision streets.

When calculating the structural number of a pavement section, consider whether vehicular traffic used the street section previously. For example:

*A subdivision has an ADT of 136. Figure 5.6-b requires that the structural number at completion be 2.98, while the pavement section in place prior to 75% completion of the development must have a structural value of 2.48. To determine the structural value of the overall section, the structural capacity of the section must be determined using SN contribution values as follows:*

*Thickness<sub>C</sub> = 2 ¾" (1 ½" placed at initial pavement construction; 1 ¼" placed after DelDOT acceptance).*

$$SN_C = 0.4 \text{ per inch}$$

$$\text{Thickness}_B = 2 \frac{1}{4}"$$

$$SN_B = 0.4 \text{ per inch}$$

$$\text{Thickness}_{GABC} = 7"$$

$$SN_{GABC} = 0.14 \text{ per inch}$$

$$SN_{total} = \text{Thickness}_C * SN_C + \text{Thickness}_B * SN_B + \text{Thickness}_{GABC} * SN_{GABC}$$

$$SN_{Total} = 2 \frac{3}{4} * 0.4 + 2 \frac{1}{4} * 0.40 + 7 * 0.14 = 2.98$$

*The structural number meets the requirements structurally for the overall value and meets the conditions set forth in the beginning of this section. Once it is established that these are sufficient, the section must be verified to meet the required structural value prior to 75% completion of the development. This calculation uses SN contribution values without the 1 1/4" Type C bituminous concrete (asphalt) pavement placed after DelDOT acceptance and is as follows:*

$$\text{Thickness}_C = 1 \frac{1}{2}''$$

$$SN_C = 0.4 \text{ per inch}$$

$$\text{Thickness}_B = 2 \frac{1}{4}''$$

$$SN_B = 0.4 \text{ per inch}$$

$$\text{Thickness}_{GABC} = 7''$$

$$SN_{GABC} = 0.14 \text{ per inch}$$

$$SN_{75\%} = \text{Thickness}_C * SN_C + \text{Thickness}_B * SN_B + \text{Thickness}_{GABC} * SN_{GABC}$$

$$SN_{75\%} = 1 \frac{1}{2} * 0.4 + 2 \frac{1}{4} * 0.40 + 7 * 0.14 = 2.48$$

This calculation shows how the required section is calculated and may be used to adjust thickness requirements of example sections as long as all requirements are met and lift thickness values are not violated.

**Figure 5.6.1-a Pavement Design Chart for Internal Subdivision Streets**

ADT	Required Structural Number – Overall (prior to 1 ¼” Type C bituminous concrete (asphalt) pavement overlay)	Bituminous Concrete (Asphalt) Pavement Section <sup>1</sup>
1– 500	2.98 (2.48)	1 ¼” Type C <sup>3</sup> 1 ½” Type C <sup>2</sup> 2 ¼” Type B 7” GABC
501 – 1000	3.12 (2.62)	1 ¼” Type C <sup>3</sup> 1 ½” Type C <sup>2</sup> 2 ¼” Type B 8” GABC
1001 – 2000	3.42 (2.92)	1 ¼” Type C <sup>3</sup> 1 ½” Type C <sup>2</sup> 3” Type B 8” GABC
2001 – 3000	3.82 (3.32)	1 ¼” Type C <sup>3</sup> 1 ½” Type C <sup>2</sup> 4” Type B 8” GABC
3001 – 5000	4.02 (3.52)	1 ¼” Type C <sup>3</sup> 2” Type C <sup>2</sup> 4” Type B 8” GABC
> 5000	Submit data to DelDOT for Pavement design	

1 - Variations from the sections provided must be approved by DelDOT.

2 - Bituminous Concrete (Asphalt) Type C course to be installed with Type B and GABC

3 - Bituminous Concrete (Asphalt) Type C course to be installed just prior to DelDOT acceptance.

### 5.6.2 Pavement Sections - Entrances

Pavement sections for entrances on State-maintained roadways are to be designed using the average daily traffic using that entrance or 20% of the mainline traffic, whichever is greater (see Figure 5.6.2-a). Other sections, to be constructed in conjunction with the entrance to the highway that must be submitted for design to DelDOT are:

- Travel lanes
- Right-turn lanes
- Bypass lanes
- Left-turn lanes
- Crossovers
- Entrances that do not conform to the description listed in Figure 5.6.2-a for each class
- Class III entrances

Figure 5.6.2-a Pavement Design Chart for Entrances

CLASS	Required Structural Number	Bituminous Concrete (Asphalt) Pavement Section <sup>1</sup>
<p><b>Class I</b></p> <ul style="list-style-type: none"> <li>Traffic Volume 51 to 500 ADT</li> <li>Limited to 1 light truck per day</li> </ul>	3.12	<p>1 ¼" Type C<sup>3</sup></p> <p>1 ½" Type C<sup>2</sup></p> <p>2 ¼" Type B</p> <p>8" GABC</p>
<p><b>Class II</b></p> <ul style="list-style-type: none"> <li>Traffic Volume 501 to 2000 ADT</li> <li>Less than 15 light duty trucks per day</li> </ul>	3.62	<p>1 ¼" Type C<sup>3</sup></p> <p>1 ½" Type C<sup>2</sup></p> <p>3.5" Type B</p> <p>8" GABC</p>
<p><b>Class III</b></p> <ul style="list-style-type: none"> <li>Traffic Volume greater than 2001 ADT</li> <li>Greater than or equal to 15 light duty trucks per day</li> </ul>	Submit traffic data to DeIDOT for Pavement design	

1 - Variations from the sections provided must be approved by DeIDOT.

2 - Bituminous Concrete (Asphalt) Type C course to be installed with Type B and GABC

3 - Bituminous Concrete (Asphalt) Type C course to be installed just prior to DeIDOT acceptance.

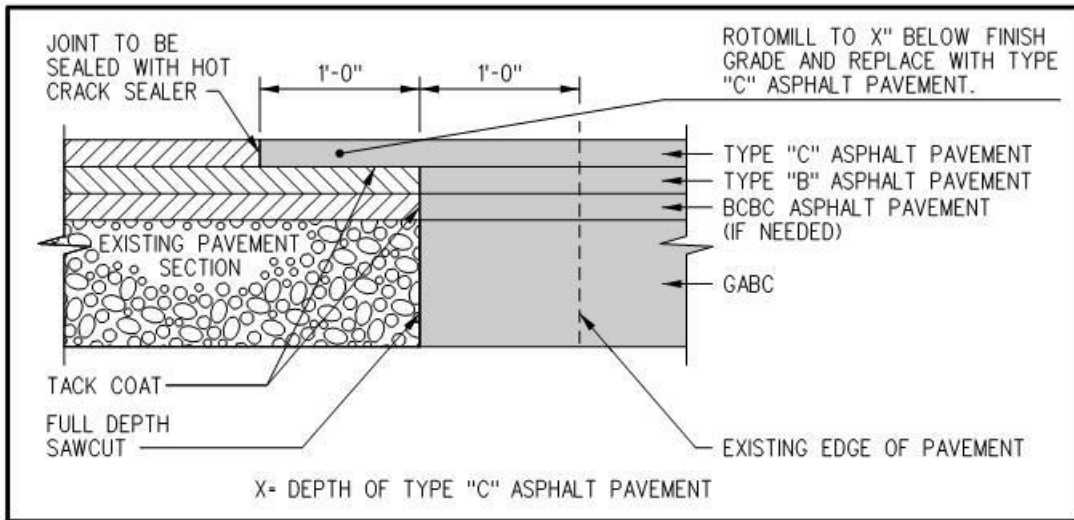
### 5.6.3 Pavement Sections Industrial Streets / Entrances

Streets that are to be used as entrances to industrial parks must be built to State requirements. DeIDOT must perform all pavement designs for proposed industrial streets, to match the design with the anticipated vehicle use.

### 5.6.4 Pavement widening

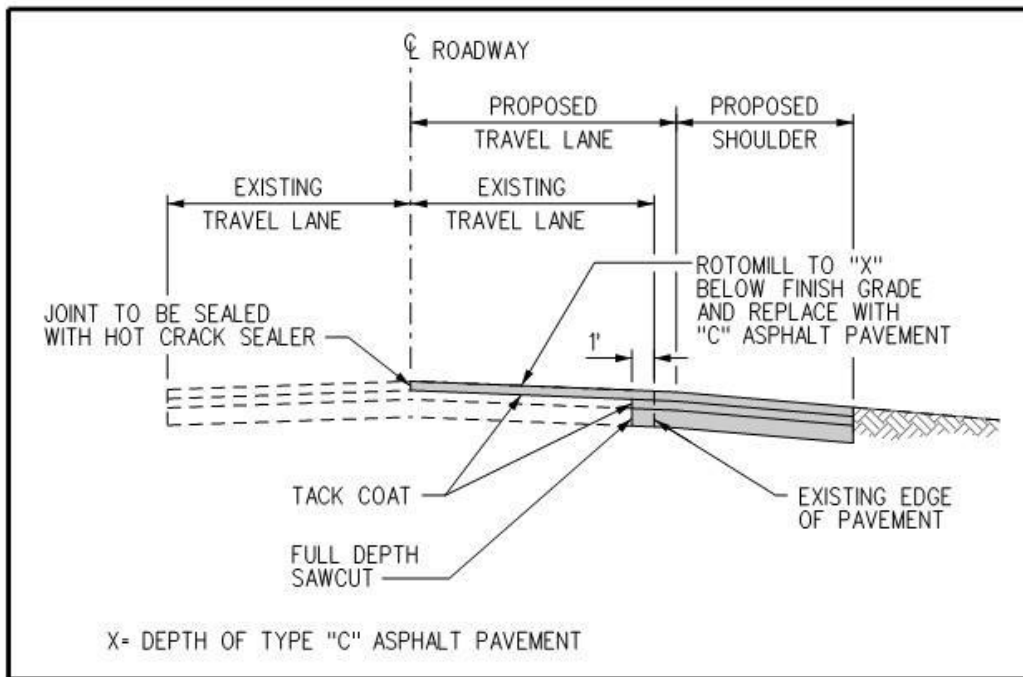
When a trench is made to install utilities or drainage across or longitudinally along an existing shoulder or a shoulder is widened, the pavement tie-in detail shall be provided on the construction plans as shown on figure 5.6.4-a.

Figure 5.6.4-a Pavement Tie-in Detail



When widening is proposed for auxiliary lanes or shoulders or utilities are to be installed longitudinally on roadways, any encroachment of one foot or more onto a travel lane requires restoration of the full lane width as shown on figure 5.6.4-b.

Figure 5.6.4-b Lane Widening/Restoration Detail



## **5.7 SUBDIVISION DRAINAGE DESIGN**

### **5.7.1 Subdivision Drainage Design - General**

Surface runoff water is a serious threat to both the physical integrity and the serviceability of roadway facilities. Runoff water must be adequately controlled so that it may pass through and be removed from the roadway area without damaging the roadway or adjacent properties, or creating safety issues.

As part of the overall design, the developer's engineer shall provide adequate drainage of the roadway and the site in accordance with all applicable standards. DelDOT maintains the authority to dictate drainage design methods and drainage design systems for all facilities that impact the Stateright-of-way.

The following sections apply to drainage design within subdivisions. For drainage and stormwater management design of entrances, offsite and frontage road improvements, applicable regulations shall be followed and relevant guidelines, standards and DelDOT policies should be applied to the design process, such as: [Chapter 6 Drainage and Stormwater Management](#) of DelDOT's *Road Design Manual*; and the reference materials found on DelDOT's Website under the Design Resource Center's *Hydraulics and Hydrology Tab* (<http://deldot.gov/information/business/drc/hydrology.shtml>) .

### **5.7.2 Subdivision Drainage Design - Drainage Criteria**

Drainage criteria for different drainage installations are discussed below and summarized in Figure 5.7.2-a.

#### **5.7.2.1 Open Channels**

Open channels are a commonly used component of a drainage system. They include natural/manmade ditches, streams, median swales and gutters.

Open Channel/ Roadside ditch design within subdivisions shall generally be in accordance with the design methodology described in DelDOT's *Road Design Manual*. The following specific criteria shall be used in the design of roadside ditches within subdivisions:

- A. A 10-year storm frequency.
- B. The rational method shall be used to compute the design runoff, and Manning's equation for capacity.
- C. Maintain a minimum freeboard of 0.5 ft., 1 ft. preferred, below the edge of shoulder.
- D. The minimum ditch grade is 0.3%, but 0.5% is preferred.
- E. Maximum allowable flow velocity is 3 ft/sec. for grass-lined channels. Higher velocities will require lining and additional review.
- F. Maximum 4:1 sideslopes are preferred, with steeper sideslopes subject to DelDOT approval.
- G. Flat bottoms with a minimum width of 2-feet are preferred, although 1' flat bottoms may be acceptable in some designs. V-ditches will only be permitted where there is no feasible alternative.

#### **5.7.2.2 Culverts**

A culvert is an open-ended drainage structure which transports water between drainage courses.

Based on the peak flow and watershed area, an appropriate method for determining runoff shall be determined. The following criteria shall be used for culverts:

- A. A 25-year storm frequency shall be used
- B. The headwater elevation shall be one foot below the edge of the proposed roadway. The resulting ponding shall not negatively impact the highway or the adjacent property.
- C. The minimum pipe size for cross-road culverts within subdivisions shall be 15”.
- D. The minimum pipe size for culverts under residential driveways within subdivisions shall be 12”.

See Hydraulic Design Series Number 5 (HDS 5), *Hydraulic Design of Highway Culverts*, September 2001, USDOT, FHWA.

### **5.7.2.3 Storm Sewers**

The following criteria shall be used for storm sewers within subdivisions:

- A. A 10-year storm frequency shall be used.
- B. For sump conditions a 25-year storm frequency shall be evaluated to assess the impacts of potential flooding in sump locations in higher storm events.
- C. The minimum size for pipes within subdivisions shall be 15”.
- D. Storm sewers should be designed for non-pressure flow. In certain cases, where site topography or other constraints warrant design of pressure flow in pipes, engineering justification and supporting calculations shall be submitted for review by DelDOT. In no case shall the hydraulic gradient be higher than one foot below the top of the grate for ten-year storms and just below the top of the grate for 25-year storms.
- E. The following criteria shall be used in calculating the Hydraulic Grade Line (HGL):
  - 1. The starting elevation of the HGL shall be the normal crown of the outfall pipe, or the tailwater elevation of the outfall, if it is higher than the normal crown of the outfall pipe.
  - 2. The HGL shall be calculated in accordance with HEC-22.
- F. The following criteria shall be used to establish the inverts of outfall pipes:
  - 1. For dry ponds, the pipe invert elevation shall be equal to the bottom of pond elevation. For wet ponds, the pipe invert elevation shall be equal to or higher than the normal pool elevation of the pond.
  - 2. For a storm drain system discharging into a stream, the invert of the discharging pipe shall be no lower than the level of the base flow. If the stream flow is intermittent, the invert shall be at least a foot above the stream bottom. The HGL shall start from the crown of the pipe.

See DelDOT’s *Road Design Manual*, [Chapter 6 Drainage and Stormwater Management](#), for additional guidance and information on storm sewer design.

Culverts and storm sewers can be made from Reinforced Concrete Pipe (RCP), Metal Pipe (MP) or High Density Polyethylene (HDPE). Refer to DGM 1-20 Pipe Materials for further information.



#### **5.7.2.4 Inlet Design**

Inlet design for subdivision streets shall be in accordance with the design methodology described in DelDOT's *Road Design Manual*. The following criteria shall be used for inlets:

- A. A 10-year storm frequency
- B. The spread of water shall be no greater than 8 feet from the flow line of the curb
- C. Maximum spacing of inlets is 300 feet
- D. Double inlets shall be used at all sump locations

#### **5.7.2.5 Pipe Cover**

Appropriate care must be taken in the layout, selection and sizing of drainage components, to ensure that adequate cover is provided over culverts and storm sewers below roadways and at storm sewer connections with drainage structures, to help assist with the cataloguing and review of these elements, DelDOT's Pipe Cover/Pipe Angle Worksheet, available online at <http://devcoord.deldot.gov> > Forms, shall be completed by the engineer and submitted for review. Pipe Materials including, rigid and flexible pipe, shall require a minimum allowable cover,  $H_{min}$ , as shown on Figure 5.7.2.5-a, which has been adapted from DelDOT's DGM 1-20 *Pipe Materials*. When rigid pipe is proposed under bituminous concrete (asphalt) pavement, extends into the bituminous concrete (asphalt) pavement section and  $H_{min}$  is met, then bituminous concrete (asphalt) pavement should be placed directly over the pipe. For this condition, refer to Figure 5.7.2.5-b to see examples for existing and proposed pavements. In addition, use of elliptical reinforced concrete pipe (ERCP) should be considered to increase pipe cover under the pavement when  $H_{min}$  cannot be provided. On roadways listed on the National Highway System where the minimum allowable cover requirement cannot be met due to field conditions, DelDOT may approve reinforced concrete pipe having AASHTO HL-93 loads as specified in the American Concrete Pipe Association's (ACPA) Concrete Pipe Manual. This will require pipe design calculations to be prepared and submitted for review and approval prior to issuance of construction plan approval. The National Highway System map can be found on DelDOT's website. Under special circumstances, on roadways not listed on the National Highway System, where the minimum cover requirement cannot be met due to field conditions, DelDOT may approve the use of class V RCP.

Figure 5.7.2.5-a Material Based Pipe Cover Requirements (Standard Installation)

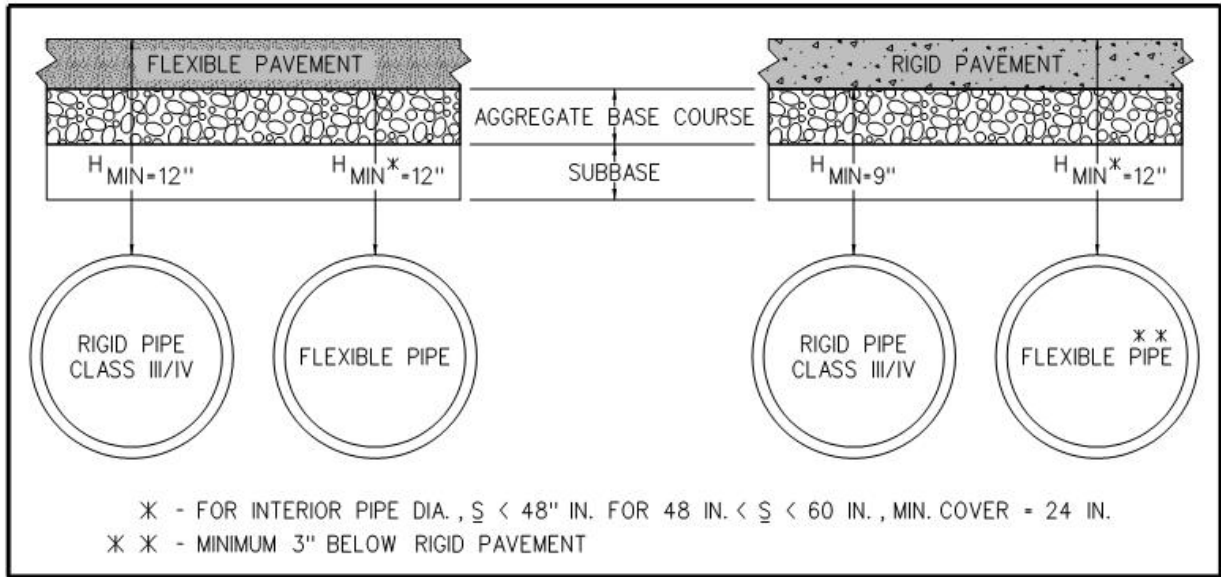
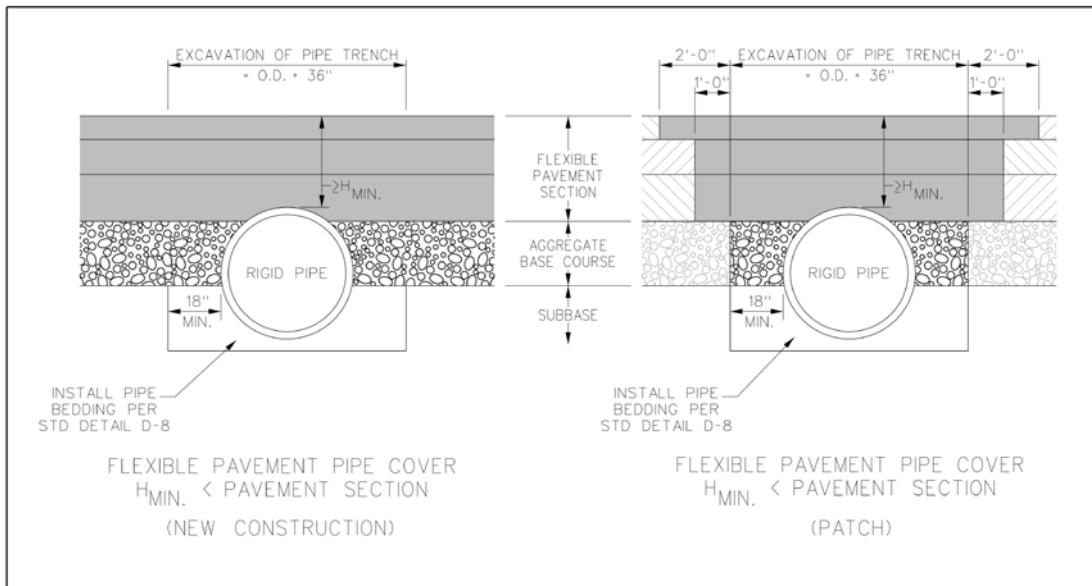


Figure 5.7.2.5-b Existing Pavement Shallow Pipe Cover Details

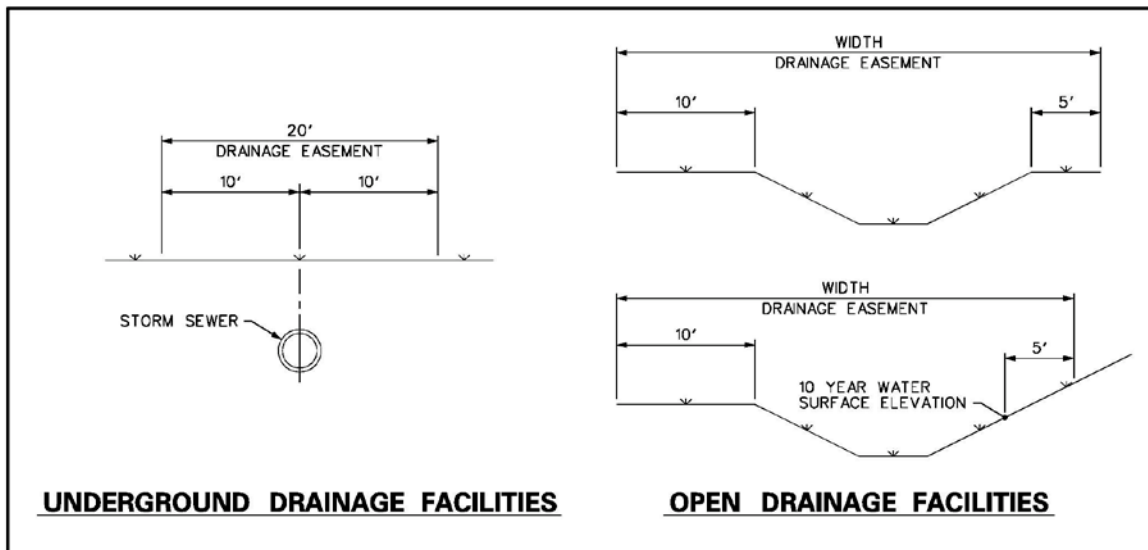


### 5.7.2.6 Drainage Easements

Drainage easements are required for all drainage facilities handling roadway runoff which are not located within a dedicated right-of-way. DelDOT may authorize the use of such drainage easements for accessing and removing downstream blockages that impede roadway runoff from the state maintained portion of the system. Downstream easements do not imply or create a maintenance responsibility on the part of the Department, but communicate the underlying authority to take emergency or corrective action if the Department believes it is appropriate. The Department will not maintain portions of the drainage easement and system that are exempted under Section 3.2.5.1.4 (such as portions that are not directly

collecting and conveying the drainage runoff of the proposed State maintained roads and/or rights-of-way, as well as portions that are located upstream or are offsite). Underground drainage facilities shall require a 20-foot drainage easement. The pipe must be located in the center of the easement. Open drainage facilities shall require a width equal to the width of the facility plus a 10-foot easement on one side and a minimum of a 5-foot easement on the other side of the open drainage facility, as measured from the top of slope. Where the top of slope is undefined, measure from the 10-year water surface elevation. Refer to Figure 5.7.2.6-a for additional detail.

**Figure 5.7.2.6-a Drainage Easement Requirements**



### 5.7.2.7 Drainage Design Report

A drainage report shall be submitted with the construction plans to verify pipe sizing, Hydraulic Grade Line (HGL), pipe cover and angles, velocities, channel lining and water spread on the roadway.

A drainage design report containing the following minimum data shall be prepared for each project:

- A. Drainage area plan
- B. Time of concentration
- C. Weighted runoff coefficient
- D. Design discharge
- E. Type and slope of drainage facility
- F. Storm drain size and type calculations
- G. Scour protection methods – riprap sizing and shear stress calculations
- H. Inlet spacing and spread calculations, including bypass flow
- I. Culverts – headwater elevations
- J. Hydraulic Grade Line (HGL) calculations
- K. Full flow pipe velocity

- L. Actual flow pipe velocity
- M. Difference between inlet grate elevation and HGL elevation
- N. Pipe cover/pipe angle calculations. Spreadsheet is available online at <http://devcoord.deldot.gov> > Forms
- O. If DelDOT is accepting maintenance responsibility for any BMP, a Drainage area shapefile for all outfall pipes is to be submitted with the report.

See DelDOT’s Design Resource Center, Hydrology & Hydraulics Section, for a sample drainage report.

See [Chapter 6 Drainage and Stormwater Management](#) of DelDOT’s *Road Design Manual* for rainfall intensity estimates and depths that are to be used in the preparation of the drainage report.

**Figure 5.7.2.7-a Subdivision Streets Drainage Criteria**

Type	Design Frequency		Minimum Flow Full Velocity (ft/sec)	Maximum Allowable Velocity (ft/sec)	Minimum Free Board from Edge of Roadway
	Normal	Sump			
Culvert	25	25	2	–	6 inches acceptable, 1 foot preferred
Storm Sewer	10	25	2	8	1 foot
Roadside Ditch	10	10	–	3	6 inches acceptable, 1 foot preferred
Inlets	10	10*	–	8	–

\* The 25-year storm event will also be evaluated for impacts.

### 5.7.2.8 Safety Grate for Pipe Inlet

Safety grates shall be installed on the inlets of stormwater pipes to improve safety on all stormwater pipes 12 inches and larger with open inlets (i.e., without a grate or drainage inlet) for which full daylight is not visible when looking through the pipe to the other end, regardless of length. Refer to DelDOT Standard Construction Details for applicable safety grate for each installation. Efforts shall be made to minimize use of open end pipe inlets which require safety grates.

### 5.7.3 Subdivision Drainage Design - Hydrology

Hydrology shall be analyzed using acceptable calculation methods (e.g. Rational Method, TR-55, etc.). Additional guidance on hydrologic calculations can be found in [Chapter 6 Drainage and Stormwater Management](#) of DelDOT’s *Road Design Manual*, TR-55, HEC-22, etc.

### 5.7.4 Subdivision Drainage Design - Hydraulics

Manning’s Equation shall be utilized to calculate the flow of water in open channels. Additional guidance can be found in [Chapter 6 Drainage and Stormwater Management](#) of DelDOT’s *Road Design Manual*.

## **5.8 STORMWATER MANAGEMENT**

The following section applies to stormwater management for disturbed areas within the State right-of-way as a result of roadway widening for turn lanes, shoulders, etc.

DelDOT will work cooperatively with Delaware Department of Natural Resources and Environmental Control (DNREC) and delegated agencies responsible for enforcing Delaware Sediment and Stormwater Regulations (DSSR) to ensure stormwater is adequately controlled. These agencies include New Castle County Land Use Engineering, New Castle County Conservation District, Kent Conservation District (KCD), and Sussex Conservation District (SCD). See the Stormwater Links online at <http://devcoord.deldot.gov> > Guidance.

Stormwater management shall meet State law and regulations in terms of quality and quantity.

When determining the need for stormwater management, the impervious areas added to the existing State-maintained roadway shall be considered. If stormwater management is required, it shall be managed by a private stormwater management facility. The area of the entrance construction and roadway improvements shall be included in the analysis and clearly documented in the stormwater report.

When the proposed development is limited to the site and the entrance, the review of design and construction of a stormwater management facility is performed by a non-DelDOT delegated agency for DSSR enforcement. In this case, the non-DelDOT delegated agency shall attest that the DSSR within DelDOT right-of-way have been met and shall be documented in a memo and forwarded to DelDOT's Stormwater Engineer.

If the proposed roadway work is not contiguous with the land development proposal, the review of design and construction of a stormwater management facility shall be performed by DelDOT's Stormwater Management Section for Delaware Sediment and Stormwater Regulations (DSSR) enforcement. The Stormwater Engineer will sign the plans upon determination of full compliance of the plans and reports with the requirements of the DSSR.

If there are proposed roadway upgrades above and beyond those required by the development project, then a shared use agreement will be entered into by DelDOT and the Developer. For any BMP that is proposed within the State's right-of-way that DelDOT will be partially or fully responsible for maintaining, a GIS shapefile of the drainage area for the area treated by the BMP shall be included with the stormwater management design report and submitted to DelDOT.

The stormwater management report shall be required in order to assess conformance with the provisions of DSSR.

The following shall also apply to all stormwater management designs:

- A. If stormwater runoff from a site does not discharge into the State right-of-way during pre-existing conditions, DelDOT will not allow the outflow to discharge into the State right-of-way.
- B. Where the outfall for any stormwater runoff outlets into the State right-of-way, a detailed hydraulic and stormwater analysis shall be required to determine the impacts on the roadway drainage system and to ensure no adverse stormwater impacts for surrounding property owners.
- C. Where the proposed stormwater runoff will alter drainage patterns, including location of discharge points into the State right-of-way, DelDOT will require supporting calculations to show that there will be no adverse impacts to the State right-of-way.

- D. If there is an identified drainage problem and the proposed site will impact the problem area, the applicant shall contribute towards mitigation through management of stormwater.
- E. If a stormwater management facility is proposed within the State right-of-way, the following will need to be submitted to DelDOT:
  - 1. Coordinates of BMP (NAD83/DE State Plane)
  - 2. BMP Data Sheet
  - 3. BMP Identification Form: After submission of the form, DelDOT will assign a BMP identification number to be shown on the stormwater management plans.

## **5.9 EROSION AND SEDIMENT CONTROL**

DelDOT will work cooperatively with Delaware Department of Natural Resources and delegated agencies to ensure proper erosion control. These agencies include New Castle County Land Use Engineering, New Castle County Conservation District, Kent Conservation District (KCD), and Sussex Conservation District (SCD).

All developments shall require a plan for erosion control measures during construction, following the requirements outlined in DSSR. The erosion and sediment control measures shall be designed following applicable regulations, guidelines and standards, such as: the Delaware Erosion and Sediment Control Handbook (Delaware ESC Handbook), to minimize erosion and sedimentation during earth moving operations.

When the proposed roadway work is limited to the site and the entrance, and the new impervious area is less than 5,000 sf, the review of the design and construction of stormwater management and erosion and sediment control facilities will be performed by a non-DelDOT delegated agency for DSSR enforcement

If the proposed roadway work is not contiguous with the land development proposal, the review of design and construction of erosion control plans shall be performed by DelDOT for DSSR enforcement. DelDOT will sign the plans upon determination of full compliance of the plans and reports with the requirements of DSSR indicating that the plans meet the requirements of State and Federal sediment and stormwater regulations.

## **5.10 STRUCTURAL DESIGN**

Any structure, including supports, erected over a depression or an obstruction, such as water, a highway or a railway, for carrying vehicular or pedestrian traffic or other moving loads that has at least a 20' span length or has an opening exceeding 20 square feet and is 48" tall shall be reviewed by DelDOT's Bridge Design Section. Other structures not meeting the above criteria, including but not limited to box culverts and non-standard drainage structures, may require a separate review by DelDOT. Additional guidance can be found on DelDOT's website in the Doing Business section.

All structural designs shall be in accordance with applicable regulations, guidelines and standards, such as: *DelDOT's Bridge Design Manual* and *AASHTO's Load and Resistance Factor Design (LRFD) Bridge Design Specifications*.

If there are structural designs required on a plan and not included in the Standard Construction Details, shop drawings signed and sealed by a professional engineer registered in the State of Delaware shall be submitted for review and approval.

## **5.11 SIGNING AND PAVEMENT MARKING DESIGN**

### **5.11.1 Signing and Pavement Marking Design - Signing**

Traffic control signs shall be required for all commercial and subdivision entrances and streets. The signs must be included on the construction plan in accordance with the DE MUTCD, and should follow applicable DelDOT guidelines and standards in addition to the requirements of this manual. All advertising signs in conjunction with a business establishment shall be placed in conformance with the current (at the time of construction) Delaware Code relating to Outdoor Advertising.

#### **5.11.1.1 Placement of Signs**

Traffic signs shall be furnished and installed by the developer in accordance with a signing plan prepared by the developer's engineer and approved by DelDOT. Signs shall be installed in accordance with the DE MUTCD and Standard Construction Detail T-15. DelDOT shall provide direction regarding necessary signs and their placement on the signing plan at the time of semi-final construction plan review.

#### **5.11.1.2 Specifications**

All signs shall conform to Federal and State specifications applicable to size, color, reflectivity, and fabrication. Developers are encouraged to seek private sources first. DelDOT shall fabricate signs upon request, provided that the developer bears all costs for the signs. Additional information pertaining to the size, colors, and fabrication of signs may be obtained by contacting DelDOT's Sign Shop at 302-760- 2000.

#### **5.11.1.3 Signs Required in Residential Development**

##### **A. Street Name Signs**

1. Placement – The location of street name signs shall be in accordance with Figure 5.11.1.3-a.
2. Specifications – Street name signs shall be fabricated in accordance with applicable regulations, guidelines and standards such as: Section 2D.43 of the DE MUTCD and the DelDOT Guide for Fabrication and Installation of Traffic Control Devices.

##### **B. Development Name Signs**

1. Placement – The development name signs shall be installed within the right-of-way of the highway on which the entrance(s) is (are) located. The signs shall be placed within 500 feet of the centerline of the entrance(s). In order to adequately notify motorists of entrances to subdivisions, one set of development name signs can be authorized per major or minor roadway on which there is an entrance.
2. The development name signs are not directional signs nor guide signs and the placement of these signs at adjacent intersections near the development or on State-maintained roads other than the road on which the entrance is located is prohibited.

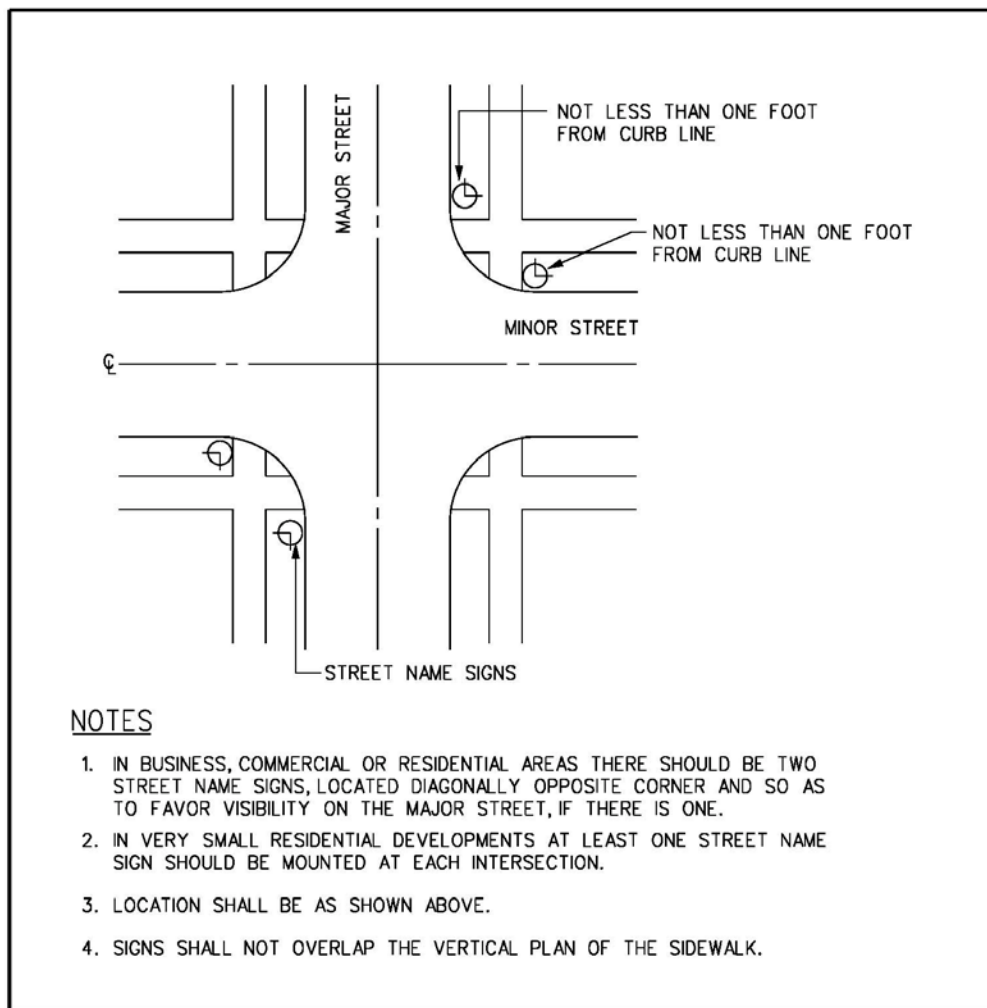
3. Specifications – All development name signs shall be fabricated in accordance with applicable regulations, guidelines and standards such as: Section 2D.50 of the DE MUTCD and the DelDOT Guide for Fabrication and Installation of Traffic Control Devices, Standard No. S-5.

C. Regulatory and Warning Signs

1. Placement – One advisory speed plaque “25 MPH”/ Pictorial “Watch Children” sign combination (typical) shall be installed at each entrance to a residential development. Other signs shall be installed in accordance with applicable regulations, guidelines and standards such as: DelDOT requirements in accordance with the DE MUTCD and the DelDOT Guide for Fabrication and Installation of Traffic Control Devices.
2. Specifications – All regulatory, warning, and other traffic control signs shall be fabricated in accordance with applicable regulations, guidelines and standards such as: Chapter 2B of the DE MUTCD and the DelDOT Guide for Fabrication and Installation of Traffic Control Devices.



Figure 5.11.1.3-a Street Name Sign Location



### 5.11.2 Signing and Pavement Marking Design - Pavement Markings

Pavement markings required as part of an entrance design shall be in accordance with DE MUTCD requirements. Type III subdivision streets shall have a centerline and edge line striping in accordance with DE MUTCD guidelines.

When pavement markings are to change on existing roadways, asphalt/pavement milling and overlay is normally performed to provide a clean surface for proposed pavement markings to be installed. A secondary option is to remove the existing pavement markings prior to installing the proposed pavement markings. Removal of pavement striping shall be performed using shot/abrasive grit or hydro-blasting. Grinding will not be permitted. The contractor's method must be approved by DelDOT prior to work beginning. Scarring of the road surface shall be repaired, but DelDOT must approve the repair method prior to work commencing. Limits of repair will be determined by DelDOT. Depending on the severity of the scarring, the Developer may be required to mill (typically to a depth of 2") and overlay the section, across full lane width(s). If the scarring is minor, the restoration may be limited to applying flat black paint or asphalt sealer to cover any exposed aggregate. If scarring isn't severe but the removal creates

shadow lines or ghost lines, the repair may not require milling and paving but the contractor will be required to apply flat black paint or asphalt sealer to the full lane width as directed by DelDOT. When the project is accepted, the Developer will be required to warranty the pavement and any repairs that were implemented where using shot/abrasive grit or hydro-blasting to remove pavement striping. The warranty period following acceptance of the project shall be 3 years.

## **5.12 MAINTENANCE OF TRAFFIC**

To ensure that traffic control for construction along State-maintained roadways has been addressed on all land development projects, a Transportation Management Plan (TMP) shall be required. DelDOT will provide guidance on the type of TMP required during the construction plan review process. The TMP must be submitted and approved prior to final construction plan approval by the Subdivision Engineer. All TMP's shall be developed in accordance with the DE MUTCD and shall be submitted to the Subdivision Engineer with the construction plans. The TMP shall be reviewed and approved by DelDOT's Safety Section. Additional guidance on TMP warrants and requirements can be found in Chapter 6 of the DE MUTCD.

Work hour restrictions may be required depending upon the type of work being performed or the type of roadway affected. See Chapter 6 of this manual for additional work hour restrictions for construction in or adjacent to residential areas.

## **5.13 SIGNAL DESIGN**

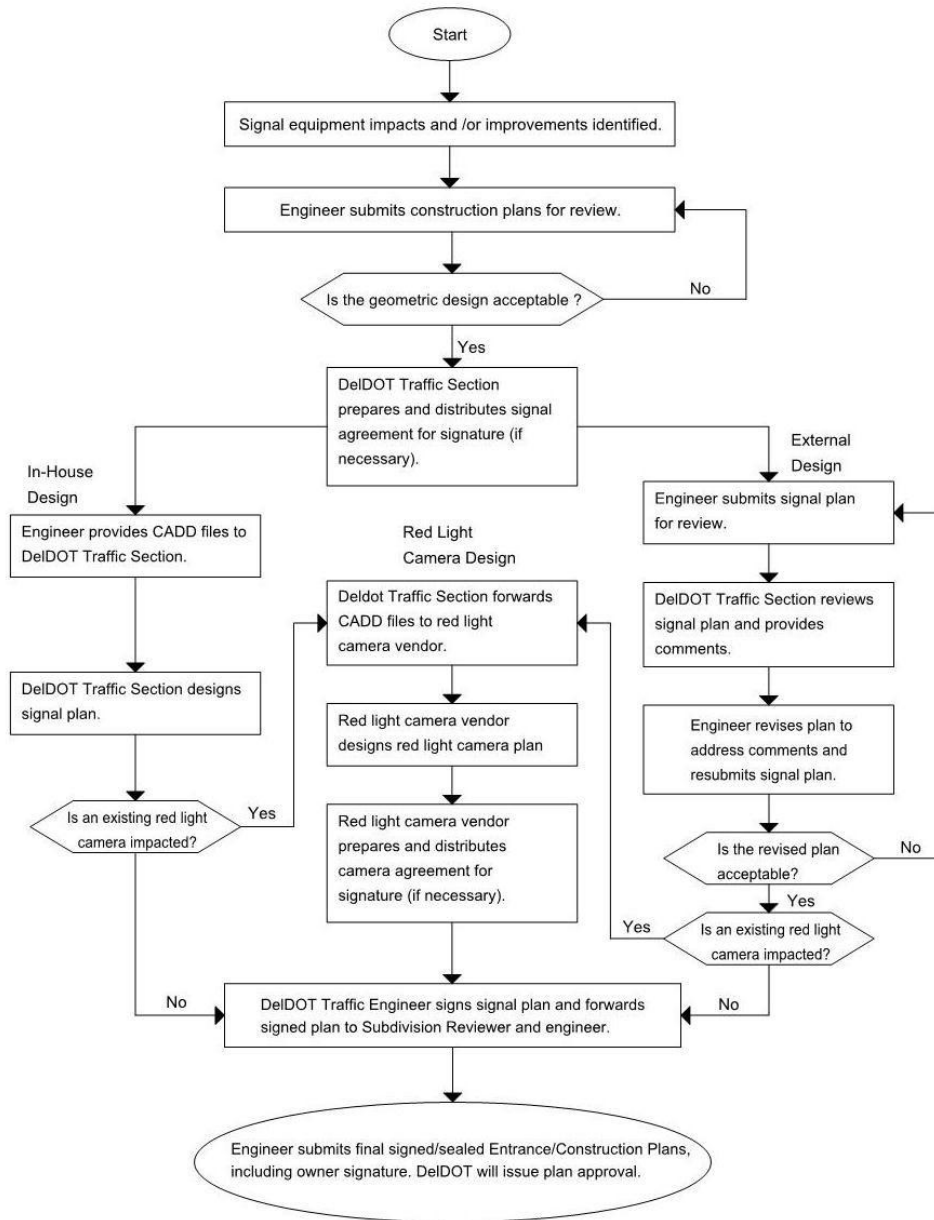
Signal design required for an entrance or offsite improvements within the right-of-way shall be performed by DelDOT's Traffic Section, their representatives or developer's representatives. Construction of pole foundations, channelizing islands, conduits, etc. shall be performed by the developer's contractor. DelDOT's on-call electrical/traffic contractor shall install the proposed signal poles, traffic signal heads, pedestrian signals, cabling and associated equipment.

Prior to beginning signal design, the engineer shall provide a copy of the approved signal justification study to DelDOT's Traffic Section for review and approval. Prior to beginning signal design, additional survey may be needed to depict all below and above ground signal equipment. Once the project's geometric, drainage, stormwater and utility designs have been developed to a point that DelDOT finds the design satisfactory and feels that no major changes are anticipated, the engineer will be asked to forward electronic files of base survey and proposed improvements in CADD format to DelDOT's Traffic Section to begin signal design.

The Traffic Section will coordinate with the local utility company as needed and complete the signal design. Close coordination between the engineer and DelDOT Traffic Section during this stage is required to efficiently complete the signal design and incorporate the signal plans into the project's design.

Once the signal plans are completed and signed by DelDOT, the Traffic Section will distribute electronic files to the site engineer to incorporate the signal plans into the project's plan set prior to DelDOT issuing plan set approval. The developer shall make a fair share contribution towards the signal design and construction costs based on DelDOT Traffic Section's estimate.

Figure 5.13-a Signal Design Flow Chart



## 5.14 UTILITY DESIGN

Utility design and relocations within the right-of-way shall be performed in accordance with DelDOT’s *Utilities Design Manual* available at [http://www.deldot.gov/information/pubs\\_forms](http://www.deldot.gov/information/pubs_forms). Where feasible, underground utilities shall be placed behind the proposed curb line or in an established utility easement.

- A. Existing utilities shall be shown on the plans with the best available information. This may be done by placing a design ticket call to Miss Utility of Delaware (1-800-282-8555) to obtain a list of utilities

having facilities within the limits of construction in order to obtain as-built plans from utility companies and/or by field designating utilities.

- B. The developer's engineer shall ensure coordination with utility companies for overhead facility relocation design (to determine real estate needs), and underground facility conflict review. Based upon the extent of underground utility conflicts, utility test pits and designation shall be performed by the applicant during design. Also, plans shall provide locations and approximate depths of large cuts and fills.

Ongoing coordination with affected utility companies is required during design so the proper amount of real estate can be acquired or dedicated to facilitate the relocation, and to coordinate these facilities with other aerial structures such as signal poles and light poles. It is also imperative that the utility test hole information be analyzed to determine which underground utility conflicts cannot be avoided. Once it is determined that it is not possible to avoid the utility conflict, the affected utility company needs to be informed as soon as possible so underground relocation design can commence. If underground utility relocation will impact real estate needs, it should be identified as early as possible.

- C. Should utility relocations be required, the engineer shall prepare and submit a utility relocation plan for review. It should also be noted that if any conflicts arise as the result of a design change after plan submittal, then the engineer shall notify the affected utility company as soon as it is identified.

## **5.15 LIGHTING DESIGN**

Lighting may be required for an entrance or offsite improvements, at the discretion of DelDOT.

Lighting design for an entrance or offsite improvements within the right-of-way will be performed in accordance with applicable guidelines and standards such as: DelDOT's *Lighting Design Guidelines*, available at [http://www.deldot.gov/information/pubs\\_forms](http://www.deldot.gov/information/pubs_forms). DelDOT's Traffic Section or their representatives will perform the lighting and electrical analysis and design and a DelDOT on-call electrical/traffic contractor shall install the proposed lighting. Once the project's geometric, drainage, stormwater and utility designs have been developed to a point that DelDOT finds the design satisfactory and feels that no major changes are anticipated, the engineer will be asked to forward the electronic files in CAD format to DelDOT's Traffic Section to begin lighting design.

The Traffic Section will coordinate with the local electric company to provide service and complete the lighting and electrical analysis and design. Close coordination between the engineer and DelDOT Traffic Section during this stage is required to efficiently complete the lighting design and incorporate the lighting into the overall project's design plan.

Once the lighting design is completed, the Traffic Section will distribute electronic files to the site engineer to incorporate the lighting plans into the project's plan set prior to DelDOT issuing plan set approval. The developer shall make a fair share contribution towards the lighting design and construction costs based on the DelDOT Traffic's estimate.