

TABLE OF CONTENTS

CHAPTER 3	RECORD PLAN DESIGN
3.1	PURPOSE.....3-1
3.2	RIGHT-OF-WAY AND EASEMENTS.....3-2
3.2.1	Right-of-Way And Easements - Record Plan Right-of-Way And Easements.....3-2
3.2.2	Right-of-Way And Easements - Control of Right-of-Way.....3-2
3.2.3	Right-of-Way And Easements - Dedicated to the Public Use.....3-3
3.2.4	Right-of-Way And Easements - Right-of-Way Monuments.....3-3
3.2.4.1	Subdivision Street Right-of-Way Monumentation.....3-3
3.2.4.2	Frontage Road Right-of-Way Monumentation.....3-3
3.2.5	Right-of-Way And Easements - Dedication of Right-of-Way And Easements.....3-3
3.2.5.1	Easement Dedication.....3-4
3.2.5.1.1	Easements.....3-4
3.2.5.1.2	Frontage Easements.....3-4
3.2.5.1.3	Shared-Use Path and Sidewalk Easements.....3-5
3.2.5.1.4	Drainage Easements.....3-5
3.2.5.2	Right of Way Dedication.....3-5
3.2.6	Right-of-Way And Easements - Reservation of Right-of-Way.....3-5
3.2.7	Right-of-Way And Easements - Reduced Right-of-Way.....3-6
3.2.7.1	Reduced Right-of-Way Applications.....3-6
3.2.7.2	Reduced Right-of-Way Criteria.....3-10
3.3	MINOR RESIDENTIAL SUBDIVISIONS.....3-10
3.3.1	Minor Residential Subdivisions - Minor Plan Submittal Process.....3-11
3.3.2	Minor Residential Subdivisions - Minor Plan Requirements.....3-11
3.3.3	Minor Residential Subdivisions - Private Streets with Shared Driveways.....3-12
3.4	COMMERCIAL OR MAJOR RESIDENTIAL SUBDIVISIONS.....3-12
3.4.1	Commercial or Major Residential Subdivisions - Record Plan Application Process.....3-12
3.4.2	Commercial or Major Residential Subdivisions - Record Plan Submittal Requirements.....3-13
3.4.2.1	Commercial or Major Residential Subdivisions - Record Plan Content.....3-15
3.4.3	Commercial or Major Residential Subdivisions - Site Entrance.....3-19
3.5	CONNECTIVITY.....3-19
3.5.1	Connectivity Requirements.....3-19
3.5.2	Transportation Networks and Connections.....3-19
3.5.3	DelDOT Subdivision Streets.....3-20
3.5.4	Connectivity - Bicycle and Pedestrian Spacing.....3-21
3.5.4.1	Bicycle Compatibility.....3-21
3.5.4.2	Shared-Use Paths and Sidewalks.....3-21
3.5.4.3	Walkways.....3-25
3.5.4.4	Access-ways.....3-27
3.5.4.5	Roadway Crossing by Bicycles and Pedestrians.....3-31
3.5.5	Connectivity - Transit Facilities.....3-31
3.5.5.1	Industrial, Institution, Retail, and Office Developments.....3-31
3.5.5.2	Residential Developments.....3-31

TABLE OF CONTENTS

3.5.5.3	Transit at Mixed Use Developments.....	3-32
3.5.6	Connectivity - Subdivision Street Intra-Connectivity.....	3-32
3.5.7	Connectivity – Interconnectivity.....	3-33
3.5.7.1	Linkages to Existing Adjacent Developments with no Connection.....	3-34
3.5.7.2	Linkages to Existing Adjacent Developments with Connection.....	3-34
3.5.7.3	Linkages to Undeveloped or Re-developable Property.....	3-34
3.5.7.4	Non Residential Cross-Access Interconnectivity.....	3-36
3.5.8	Connectivity – Hindrances.....	3-37
3.6	NOISE MITIGATION	3-37
3.6.1	Highway Transportation Noise Standards.....	3-38
3.6.2	Noise Abatement Criteria.....	3-38
3.6.3	Developer Responsibilities: Site Improvements.....	3-39
3.6.4	Developer Responsibilities: Off-Site Improvements.....	3-40
3.6.5	Decision Criteria.....	3-40
3.6.6	Reasonableness.....	3-41
3.7	LANDSCAPING.....	3-42
3.7.1	Landscaping - Median Islands.....	3-43
3.7.2	Landscaping - Reforestation Regulations and Ordinances.....	3-43
3.8	STORMWATER AND DRAINAGE REQUIREMENTS FOR RECORD PLAN.....	3-44
3.9	TRAFFIC CALMING.....	3-44

LIST OF FIGURES

Figure 3.2.1-a	Minimum Right-of-Way Width.....	3-2
Figure 3.2.5-a	Minimum Standards for Total Roadway Right-of-Way.....	3-4
Figure 3.2.5-b	Typical Section – Various Roadway Types.....	3-7
Figure 3.2.5-c	Typical Section – Various Roadway Types.....	3-8
Figure 3.3.2-a	Acceptable Driveway Range.....	3-11
Figure 3.4.2-a	Traffic Generation Diagram.....	3-17
Figure 3.4.2-b	Requirements for Adjacent Existing Features on Record Plans.....	3-17
Figure 3.4.2-c	Requirements for Adjacent Existing Features on Record Plan – Direct Frontage.....	3-18
Figure 3.4.2-d	Requirements for Adjacent Existing Features on Record Plan – Limited Frontage.....	3-18
Figure 3.5.4.2-a	Sidewalk Designs.....	3-23
Figure 3.5.4.2-b	Sidewalk/Shared Use Path Tie-in.....	3-24
Figure 3.5.4.3-a	Locating Walkways.....	3-25
Figure 3.5.4.3-b	Walkway Routing.....	3-26
Figure 3.5.4.3-c	Walkway Designs.....	3-26
Figure 3.5.4.4-a	Access-way Width.....	3-28
Figure 3.5.4.4-b	Access-ways – 660’ < Block Length < 1320’.....	3-29
Figure 3.5.4.4-c	Access-ways – Block Length > 1,320.....	3-29
Figure 3.5.4.4-d	Access-ways – Cul de Sac Connection.....	3-30
Figure 3.5.4.4-e	Access-ways – Community Facilities.....	3-30
Figure 3.5.6-a	Intra-connectivity – Minimum Required Connectivity Ratio.....	3-33
Figure 3.5.7.3-a	Subdivision Street Interconnections.....	3-35
Figure 3.5.7.4-a	Non-Residential Cross-Access Interconnectivity.....	3-36
Figure 3.6.3-a:	Noise Abatement Criteria.....	3-39
Figure 3.7-a	Street Trees.....	3-43

CHAPTER 3 RECORD PLAN DESIGN

3.1 PURPOSE

This chapter is intended to provide those seeking access to state-maintained roadways and/or who wish to construct subdivision streets that will be maintained by DelDOT with:

- Specific standards and design guidance needed to assure adequate Record Plan design in the development of site transportation facilities; and
- The elements that need to be provided to DelDOT on the Record Plan so that DelDOT can provide the applicable local land use agency with a letter of “No Objection to Recordation” (LONOR).

Record Plans shall be in the format required by the local land use agency. The elements that DelDOT requires as part of this chapter shall be included on those plans.

The letter of “No Objection to Recordation” is not a DelDOT endorsement of the project. Rather, it is a recitation of the transportation improvements which the applicant may be required to make as a pre-condition to recordation steps and deed restrictions as required by the respective county/municipality in which the project is located. If transportation improvements are necessary, they are based on an analysis of the proposed project, its location, and its estimated impact on traffic movements and densities. The required improvements conform to DelDOT’s published rules, regulations and standards. Ultimate responsibility for the approval of any project rests with the local government in which the land use decisions are authorized. There may be other reasons (environmental, historic, neighborhood composition, etc.) which compel that jurisdiction to modify or reject this proposed plan even though DelDOT has established that these enumerated transportation improvements are acceptable.

The Applicant’s Record Plan must be completed within the context of the surrounding area by providing street types and connections consistent with the existing and future transportation network. Requirements for transportation facility rights-of-way, traffic calming, and operational analysis are also addressed in this chapter.

Design features that fall outside normal design criteria and accepted practice are to be determined using sound engineering judgment and must be thoroughly documented. The final design must meet the needs and expectations of DelDOT and the community, as well as providing for the users’ safety.

3.2 RIGHT-OF-WAY AND EASEMENTS

DelDOT has jurisdiction over the public right-of-way, which provides for pavement, drainage, pedestrian facilities, lighting, landscaping and the roadside. The applicant’s engineer is responsible for defining and verifying the existing right-of-way and/or easements on State-maintained roadways. The right-of-way must be evaluated to determine if the existing width can accommodate the construction and maintenance of any improvements within the right-of-way. DelDOT must approve the placement of anything within the right-of-way. Non-compliant structures and roadside obstructions shall be removed at DelDOT’s direction prior to the acceptance of improved section of the right-of-way.

3.2.1 Right-of-Way And Easements - Record Plan Right-of-Way And Easements

The widths of the right-of-way shall be in accordance with Figure 3.2.1-a. Refer to Section 5.4 for information on intersection sight easement requirements and Section 5.7.2.6 for information on drainage easement requirements. Additional right-of-way and/or easements may be required at existing or future signalized intersections for signal poles and devices.

Figure 3.2.1-a Minimum Right-of-Way Width

Roadway Type	Minimum Right-of-Way Width
Subdivision Street – Type I (< 500 ADT)*	50 feet
Subdivision Street – Type II (501 – 3000 ADT)* Type III (> 3000 ADT)*	60 feet
Industrial Street (plus 15 foot wide storm drainage easement on both sides)	60 feet
Local Road	60 feet
Collector (Major and Minor)	80 feet

**Provide an additional ten-foot drainage easement on both sides for subdivision streets with open drainage.*

Note: At intersection streets the right-of-way shall have a minimum radius of 25 feet.

3.2.2 Right-of-Way And Easements - Control of Right-of-Way

The Record Plan shall contain one of the following notes relative to future maintenance of the internal street system:

- A. State Maintenance – Subdivision streets constructed within the limits of the right-of-way dedicated to the public use shown on this plan are to be maintained by the Delaware Department of Transportation (DelDOT) following the acceptance of the streets. DelDOT assumes no maintenance responsibilities within the dedicated street right-of-way until the streets have been accepted by DelDOT.

- B. Municipal Maintenance – Subdivision streets constructed within the limits of the right-of-way dedicated to the public use shown on this plan are to be maintained by the municipality following the acceptance of the streets. DelDOT assumes no maintenance responsibilities within the dedicated street right-of-way.
- C. Private Maintenance – Private streets within this subdivision shall be maintained by the Developer, the property owners within this subdivision or both (Title 17, Section 131). DelDOT assumes no responsibility for the future maintenance of these streets.

3.2.3 Right-of-Way And Easements - Acceptance of Right-of-Way Dedicated to the Public Use

DelDOT will only accept the maintenance of roadways with right-of-way dedicated to public use. The dedication of right-of-way shall be approved by DelDOT prior to recording the plan by the local land use agency.

The maintenance responsibility of DelDOT within the dedicated right-of-way is outlined in Chapter 6.

3.2.4 Right-of-Way And Easements

3.2.4.1 Right-of-Way Monuments - Subdivision Street Right-of-Way Monumentation

The developer shall be required to furnish and place right-of-way monuments on the dedicated subdivision street right-of-way in accordance with this *Development Coordination Manual*, and the requirements of the land use agency. Right-of-way monuments shall be placed along the right-of-way lines, at a minimum on one side of the street at every change in horizontal alignment to provide a permanent reference for re-establishing the centerline and right-of-way line. Right-of-way monuments shall be set and/or placed by a Professional Land Surveyor (PLS) licensed in Delaware and located on a monumentation plan to be provided with the as builts. Right-of-way monuments shall be located and punched so the center is on the right-of-way line. Details of standard right-of-way monuments are shown in DelDOT's Standard Construction Details.

3.2.4.2 Frontage Road Right-of-Way Monumentation

Right-of-way markers shall be placed to provide a permanent reference for re-establishing the right-of-way and property corners on frontage roads. Right-of-way markers shall be set and/or placed along the frontage road right-of-way at property corners and at each change in right-of-way alignment by a Professional Land Surveyor (PLS) licensed in Delaware. Frontage road right-of-way markers shall consist at a minimum of capped rebar/pins, and shall be located and punched so the center is on the dedicated right-of-way line.

3.2.5 Right-of-Way And Easements - Dedication of Right-of-Way And Easements

The subdivision, development or redevelopment of property adjacent to a State-maintained roadway is subject to a dedication of right-of-way sufficient to provide a total roadway right-of-way in accordance with the minimum standards shown in Figure 3.2.5-a.

This width provides for future roadway improvements to accommodate the forecasted traffic based on the Record Plan and the local land use agency's comprehensive plan. Figures 3.2.5-b, 3.2.5-c, and 3.2.5-d show typical sections for various road types.

Figure 3.2.5-a Minimum Standards for Total Roadway Right-of-Way

Department of Transportation Functional Classification Map	Minimum Dedicated Right-of-Way
Local Road or Street (All roads other than Subdivision Streets not shown)	30 feet of right-of-way from physical centerline of road, see Figure 3.2.5.b.
Two-lane: Minor Arterials and Collectors	40 feet of right-of-way from physical centerline of road, see Figure 3.2.5.c.
Two-Lane: Principal Arterial	50 feet of right-of-way from physical centerline of road
Multi-lane: Arterials (minor and principal), Collectors, Freeways and Expressways	30 feet of right-of-way from outermost edge of the through lane(s), see Figure 3.2.5.d.

3.2.5.1 Easement Dedication

3.2.5.1.1 Easements

An easement or open space shall be established at the entrance of all subdivisions for the purpose of a planned or future neighborhood sign or structure. This area shall be located outside of any existing or proposed right-of-way. If there is no easement area available because of limited site frontage, provisions may be made to locate the gateway feature within the right-of-way provided that a right-of-way use agreement is executed and the gateway feature does not pose a sight distance or safety hazard. The ability to locate a gateway feature within the right-of-way will be at the sole discretion of DelDOT.

3.2.5.1.2 Frontage Easements

A 15-foot easement beyond the minimum right-of-way listed in Figure 3.2.5-a, must be established along the property frontage to provide for infrastructure , such as: drainage, lighting, pathways, sidewalks, traffic control and monitoring equipment and systems, transit facilities, utility installations and utility systems etc. This easement may be required regardless of the inclusion of a shared-use path or any other features. The following note should be added to the plan: *“A 15-foot permanent easement is hereby established for the State of Delaware as per this plat.”*

3.2.5.1.3 Shared-Use Path and Sidewalk Easements

In areas where a proposed Shared-Use Path (SUP) and/or Sidewalk (SW) is designed to meander beyond the minimum right-of-way listed in Figure 3.2.5-a and outside of the 15-foot Frontage Easement required in Section 3.2.5.1.2, an additional permanent easement must be established to provide for the SUP/SW and any topographical changes that are directly related to the meandering of the SUP/SW. These easements will require additional metes and bounds and other documentation to clarify the exact location and extents of these permanent easements. The following note should be added to the plan: *“A permanent easement containing X square feet is hereby established for the State of Delaware as per this plat.”*

3.2.5.1.4 Drainage Easements

Drainage easements are required for all drainage facilities which collect or convey roadway runoff, but are not located within a dedicated right-of-way. Drainage easements must be shown and labeled on the Plans, and must take into account the requirements of Sections 3.8 and 5.7.2.6 of this manual. These easements will require additional metes and bounds and other documentation to clarify the exact location and extents of these permanent easements. A note which includes the following language should be added to the plan: *“A(n) X-foot wide permanent easement containing X square feet is hereby established for the State of Delaware as per this plat, for emergency access to drainage facilities conveying runoff from State maintained roads and/or rights-of-way. The portions of the drainage easement and system that are upstream or offsite as well as sections that are not directly collecting and conveying the drainage runoff of the proposed State maintained roads and/or rights-of-way shall be the responsibility of the developer, property owners, or both. The State of Delaware assumes no responsibility for the future maintenance of any exempted portions of the storm drain system and/or drainage easements.”*

3.2.5.2 Right of Way Dedication

The applicant’s engineer shall verify how the right-of-way was acquired for the road in order to determine which dedication note to use.

If the existing right-of-way for the State-maintained roadway was previously acquired as a permanent easement, then the additional right-of-way dedication will be from the centerline along with the following note:

“An X-foot wide strip of right-of-way from the centerline is hereby dedicated to the State of Delaware as per this plat.”

If the existing right-of-way for the State-maintained roadway was previously acquired in fee, then the additional right-of-way dedication will be from the existing right-of-way line along with the following note:

“An additional X-feet of right-of-way is hereby dedicated to the State of Delaware as per this plat.”

Per 17 Del.C.§ 530, DelDOT cannot require a dedication of land along a State-maintained roadway for a minor subdivision plan that meet the requirements set forth in 17 Del.C.§ 530, unless DelDOT can adequately demonstrate that additional right-of-way is necessary due to safety concerns caused by the proposed subdivision. The right-of-way that would normally be dedicated shall be reserved in accordance with Section 3.2.6.

3.2.6 Right-of-Way And Easements - Reservation of Right-of-Way

Where DelDOT has established a need for future right-of-way beyond what is shown in Figure 3.2.5-a, the frontage adjacent to proposed subdivisions shall be reserved for future right-of-way, and the following note shall be added to the plan:

“An X-foot wide strip is hereby reserved for the State of Delaware as per this plat, for future right-of-way needs.”

Setback requirements by the local zoning code are to be measured from the reserved right-of-way line.

3.2.7 Right-of-Way And Easements - Reduced Right-of-Way

Upon request, DelDOT shall consider a reduction in the required right-of-way for subdivision streets. DelDOT shall accept the maintenance of subdivision streets with reduced right-of-way as outlined in Chapter 6.

3.2.7.1 Reduced Right-of-Way Applications

Reduced right-of-way can be applied to:

- A. Streets that are dedicated to public use and shall not require widening due to future land development
- B. Areas where upright or barrier-type curbs are utilized along all interior streets
- C. Group, semi-detached, two-family, and single family dwellings constructed on fee simple lots
- D. Subdivision Streets Type I
- E. Areas where the Record Plan has incorporated the use of alleys to serve as the major access to the lots

Figure 3.2.5-b Typical Section – Various Roadway Types
(Not to Scale)

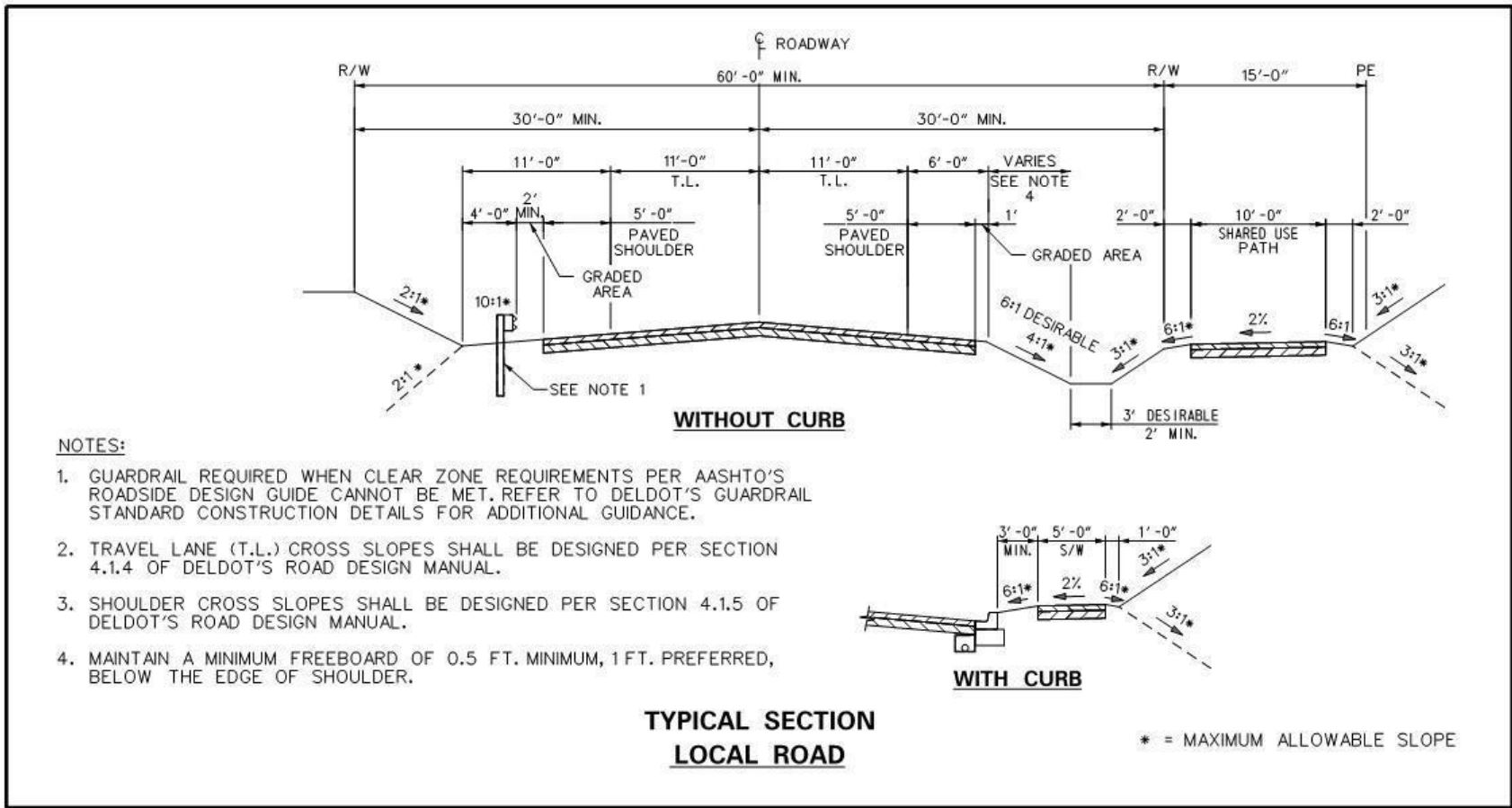

Figure 3.2.5-c Typical Section – Various Roadway Types
(Not to Scale)

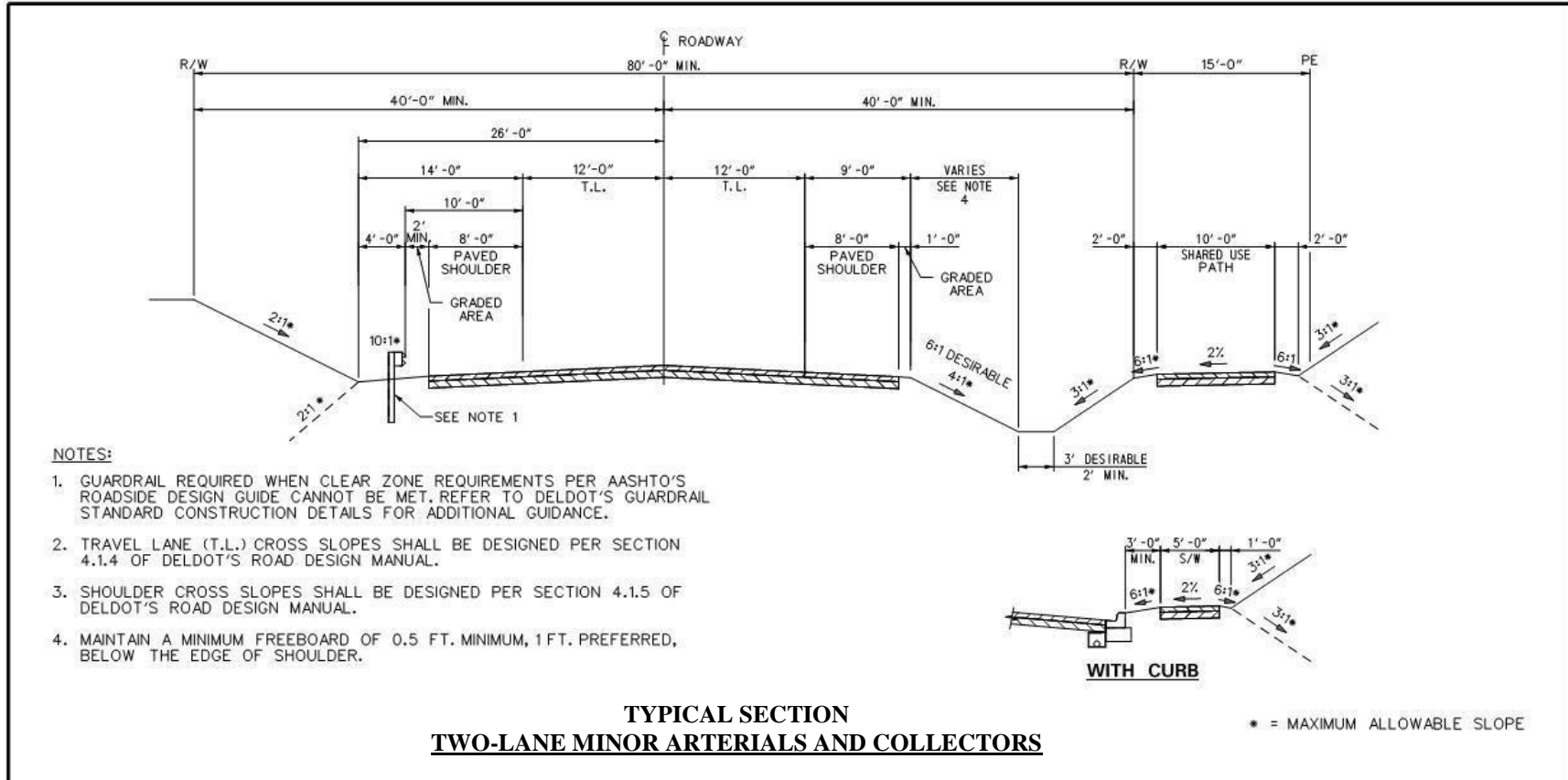
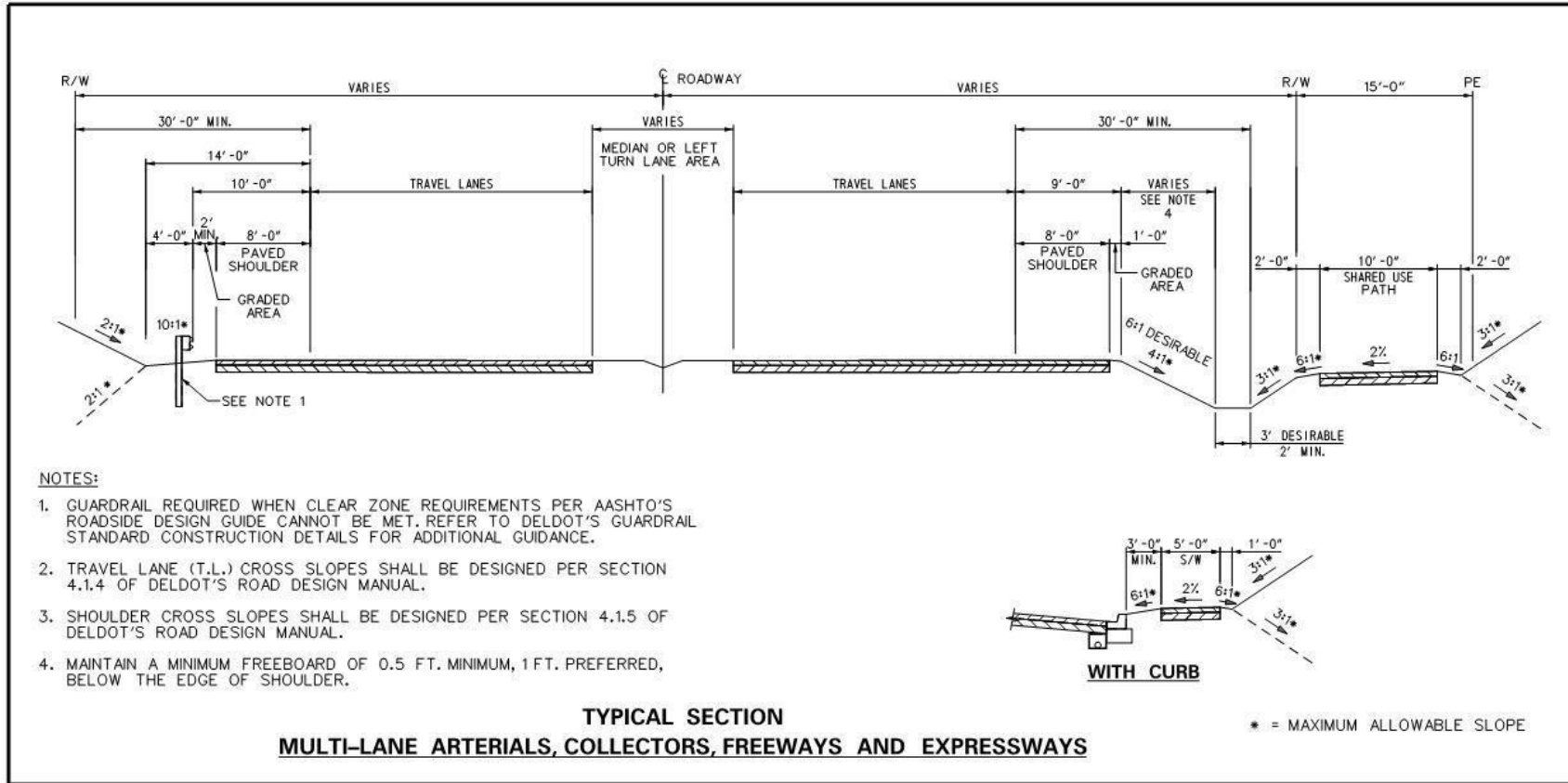

Figure 3.2.5-d Typical Section – Various Roadway Types

(Not to Scale)



3.2.7.2 Reduced Right-of-Way Criteria

DelDOT shall only consider a reduced right-of-way if the following criteria are met:

- A. Proposed reduced right-of-way is consistent with the local land use agency's ordinances
- B. The reduced right-of-way line shall be located at the back of the curb. The minimum reduced right-of-way width shall be 28 feet.
- C. A minimum 10-foot permanent easement shall be provided along each side of all streets to allow DelDOT personnel to undertake routine and emergency maintenance work and shall also be available for utility and construction purposes, and permanent placement of signs and traffic control devices.
- D. On-street parking within the reduced right-of-way shall be reduced by providing:
 - 1. Two spaces (minimum) on each lot
 - 2. One space per every three units (overflow parking) which may be provided outside the public right-of-way. These parking bays are perpendicular and shall be graded wherever possible to slope toward the street. Regardless of the slope, away from or toward the street, a concrete gutter shall be required along the street right-of-way line for carrying stormwater flow, creating a physical separation of streets from parking bays and demarcation of the reduced right-of-way. Sidewalks shall be constructed parallel to the curb line. The barrier type around the perimeter of the parking bays (when required) shall be subject to DelDOT approval.
- E. Whenever possible, all utilities, except for surface drainage appurtenances, shall be located outside the right-of-way.
- F. Turnarounds, independent of the parking bay areas, must be provided at the end of the streets to permit maneuvering of service and emergency vehicles.
- G. Any utility work within the permanent easement shall proceed only after prior notice of at least 24 hours has been given to DelDOT.

3.3 MINOR RESIDENTIAL SUBDIVISIONS

If a property owner is seeking to subdivide its residential property into five or less lots through the local land use agency process and is not constructing any internal subdivision streets, the property owner must coordinate access with DelDOT. DelDOT has established requirements for access, drainage, and adequacy of adjacent roadway right-of-way. These elements must be addressed prior to DelDOT issuing its letter of "No Objection to Recordation" to the local land use agency.

Chapter 1 outlines the minimum standard for the spacing of residential drives and shall be used to determine entrance locations. If this spacing cannot be met for each individual lot, each pair of lots shall be required to have a single combined access.

3.3.1 Minor Residential Subdivisions - Minor Plan Submittal Process

An initial stage fee calculation form which is available online (for more information go to <http://devcoord.deldot.gov> > Forms) and fee payment is to be submitted through DelDOT's online submission portal.

A completed minor subdivision plan checklist which is available online (for more information go to <http://devcoord.deldot.gov> > Checklists) is to be submitted. The applicant shall make revisions or additions to the design upon receipt of comments from DelDOT. If revisions are required, the applicant shall revise the plans and resubmit to the Subdivision Section. Once all comments have been addressed, DelDOT will issue a letter of "No Objection to Recordation" to the local land use agency. When access provisions cannot be provided in accordance with DelDOT's requirements due to limitations particular to the site or where the applicant refuses to comply, the access application for the intended use may be denied.

3.3.2 Minor Residential Subdivisions - Minor Plan Requirements

The location and design of driveways and entrances shall meet the general geometric requirements of DelDOT and comply with Chapter 7. Lots and entrances shall be laid out with consideration for possible future connections to adjoining land. If the entrance location of the subdivided lot has not been determined at the time of the electronic plan submittal, then an acceptable driveway range should be shown on the plan as depicted in Figure 3.3.2-a. If a change in driveway location is proposed outside of the acceptable driveway range by the owner after the letter of "No Objection to Recordation" has been issued, then it must be approved by DelDOT. This process may result in delay of issuance of entrance permit. In addition, sight distance and drainage requirements shall conform to Sections 5.4 and 5.7 of this *Development Coordination Manual*.

Figure 3.3.2-a Acceptable Driveway Range

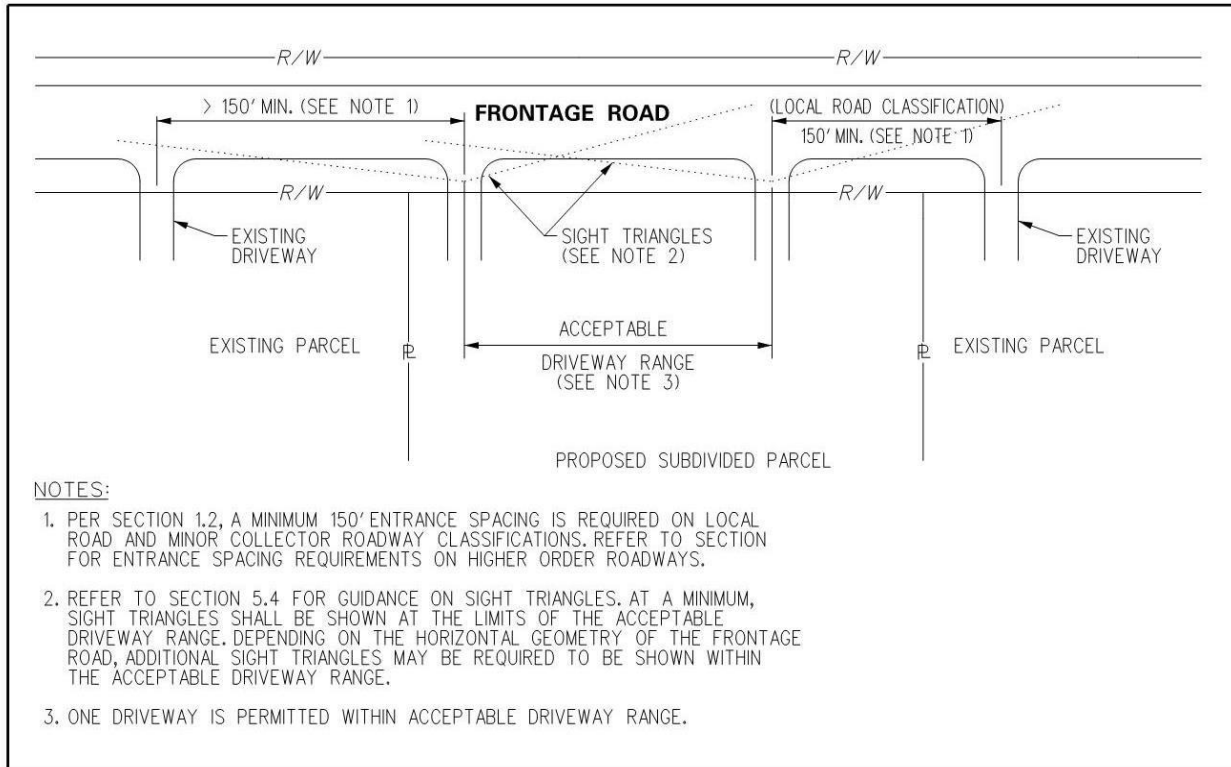

The plan for a minor residential development on a State-maintained roadway shall include the items as specified in Section 3.4.2.1 A., B., C. and D., as well as the following note:

“If the residual lands of the applicant are ever developed into a major subdivision, then the access to the minor subdivision parcels may be required to be from an internal subdivision street.”

3.3.3 Minor Residential Subdivisions – Private Streets with Shared Driveways

Entrances to private streets serving multiple residential lots should be paved, from the edge of the travel lane to the ROW line (at a minimum), with a driveway/throat width of 16 to 24 feet and should generally meet the geometric criteria shown in the agricultural entrance example for **Collector Frontage Roads** shown in **Figure 8.5.2-a Agricultural Entrance Detail**. The submittal process for review of the entrance to the private street will be coordinated and included with the **Minor Plan Submittal Process** as outlined in Section 3.3.1. The entrance location must be determined in accordance with DelDOT requirements and clearly shown on the electronic plan submittal. If a change in the location of the entrance to a private street is proposed by the landowner after the letter of “No Objection to Recordation” has been issued, then it must be approved by DelDOT. This process may result in delay of issuance of entrance permit. In addition, sight distance and drainage requirements shall conform to Sections 5.4 and 5.7 of this *Development Coordination Manual*. Entrances to private streets should be paved (unless directed otherwise by DelDOT), with bituminous concrete using the residential paving sections matching Figure 7.2.3.7-a, and shall be subject to permit conditions similar to those listed in Section 8.4.D for Temporary / Seasonal Entrances.

3.4 COMMERCIAL OR MAJOR RESIDENTIAL SUBDIVISIONS

If a property owner / developer is seeking to subdivide their property into six or more residential lots or constructing internal subdivision streets or developing a commercial site through the local land use agency process, they must coordinate access with DelDOT. A residential subdivision of 6 or more lots will require construction of internal streets. The developer shall submit the required information to DelDOT for review and approval prior to DelDOT issuing its letter of “No Objection to Recordation” to the local land use agency.

The Plan shall be in the format required by the local land use agency supplemented with DelDOT’s requirements as outlined in this chapter. DelDOT shall require recordation of the Plan regardless of the local land use agency recordation requirement. These elements shall be addressed prior to DelDOT issuing its letter of “No Objection to Recordation”.

3.4.1 Commercial or Major Residential Subdivisions - Record Plan Application Process

Prior to submitting the Record Plan for review, a pre-submittal meeting with DelDOT is required for projects generating 200 or more site ADT. If a DelDOT LONOR is more than 5 years old, a new pre-submittal meeting and application process is required. For any project: additional pre-submittal meetings should be held prior to a submittal for DelDOT review (unless directed otherwise by DelDOT): if the last pre-submittal meeting or plan submittal to DelDOT for the project is more than one (1) year old, or if the project’s scope has changed (including site changes, changes to local roadways or planned local transportation improvements). See DelDOT’s Meeting Request Form which is available online for meeting request requirements (for more information go to <http://devcoord.deldot.gov> > Forms).

The Record Plan shall be submitted through DelDOT's online submission portal. The submittal shall contain all information on the Critical Items list and the plan will follow the requirements of Section 3.4.2. For Commercial Projects, a Record Plan - Right of Way, Easement and Dedication – (RED) may be submitted. The Record Plan – RED and a separate Site Plan may be submitted, in lieu of a Record Plan submittal. Together the Record Plan – RED and the Site Plan will meet the requirements for a Record Plan submission. Refer to <http://www.deldot.gov/information/business/> under Development Coordination for a plan review schedule. The applicant shall make revisions or additions to the design upon receipt of comments from DelDOT and resubmit to the Development Coordination Section. Once all comments have been addressed, submit signed and sealed plans for approval. DelDOT will issue a letter of “No Objection to Recordation” to the local land use agency.

DelDOT's District office shall require a copy of the above-mentioned recorded Record Plan showing all appropriate signatures, seals and plot book and page, which is consistent with the DelDOT "No Objection to Recordation" stamped plan, prior to issuing the entrance permit.

When access provisions cannot be provided in accordance with DelDOT's requirements due to limitations particular to the site or where the applicant refuses to comply, the access application for the intended use may be denied.

3.4.2 Commercial Or Major Residential Subdivisions - Record Plan Submittal Requirements

- A. The Record Plan shall be prepared in accordance with the local land use agency's requirements. The following elements are supplemental information required by DelDOT to be addressed and/or included with the Record Plan submittal:
1. Completed Record Plan checklist (for more information go to <http://devcoord.deldot.gov> > Checklists) Failure to submit required documents will result in delays reviewing and approving submittals.
 2. Completed design criteria form for 3 digit state maintained roads (for more information go to <http://devcoord.deldot.gov> >Forms).
 3. Completed design deviation form and supporting documentation, if applicable
 4. Completed checklist for subdivision record plan approval (for more information go to <http://devcoord.deldot.gov> > Checklists)
 5. Initial stage fee calculation forms (for more information go to <http://devcoord.deldot.gov> >Forms)
 6. Preliminary entrance plan - Plan shall include but not be limited to the following items (see Chapter 4 for complete list of requirements):
 - i. Traffic generation diagram, including the design vehicle for the site (for more information, see Figure 3.4.2-a and DelDOT's *Traffic Generation Example* which is available online at <http://devcoord.deldot.gov> > Guidance)
 - ii. Adjacent entrances
 - iii. Functional classification of adjacent roadway
 - iv. Layout of required auxiliary lanes and bike and pedestrian facilities with supporting documentation and a completed auxiliary lane worksheet. Auxiliary lane worksheet and typical entrance diagrams are available on DelDOT's website at: <http://devcoord.deldot.gov> > Forms.
 - v. Sight distance triangles with supporting calculations and Intersection Sight Distance (ISD) spreadsheet found on DelDOT's website at: <http://devcoord.deldot.gov> > Checklists.

- vi. Transit facilities and bus pull offs including existing facilities along with improved or proposed facilities, if recommended by the local land use authority.
 7. Turning movement diagrams for specified design vehicle (a separate plan sheet or exhibit is acceptable)
 8. To facilitate review of the plans, the new entrance(s) shall be staked in the field in order to determine the feasibility of the design based on the following procedures:
 - i. Place two wooden stakes at the entrance. The stakes shall be visible 24 inches to 36 inches above the ground. The stakes shall be placed 24 feet apart, and as close to the roadside property line as possible, while being clearly visible from the road. The stakes shall not be set closer than five feet from the edge of pavement.
 - ii. Tie ribbons or apply yellow paint to the top of stakes to make them clearly visible.
 - iii. Write the property owner's last name on each stake.
- B. For Commercial plans only, you have the option of submitting a Record Plan - RED and a Site Plan instead of a Record Plan. The following elements are required by DelDOT to be addresses and/or included with the Record Plan - RED and Site Plan submittal:
1. Completed Record Plan - RED checklist (for more information go to <http://devcoord.deldot.gov>> Checklists) Failure to submit required documents will result in delays reviewing and approving submittals.
 2. Completed design criteria form (for more information go to <http://devcoord.deldot.gov> > Forms)
 3. Completed design deviation form and supporting documentation, if applicable
 4. Initial stage fee calculation forms (for more information go to <http://devcoord.deldot.gov> > Forms)
 5. Preliminary entrance plan - Plan shall include but not be limited to the following items (see Chapter 4 for complete list of requirements):
 - i. Traffic generation diagram, including the design vehicle for the site (for more information, see Figure 3.4.2-a and DelDOT's *Traffic Generation Example* which is available online at <http://devcoord.deldot.gov> > Guidance)
 - ii. Adjacent entrances
 - iii. Functional classification of adjacent roadway
 - iv. Layout of required auxiliary lanes and bike and pedestrian facilities with supporting documentation and a completed auxiliary lane worksheet. Auxiliary lane worksheet and typical entrance diagrams are available on DelDOT's website at: <http://devcoord.deldot.gov> > Forms &> Guidance.
 - v. Sight distance triangles with supporting calculations and Intersection Sight Distance (ISD) spreadsheet found on DelDOT's website at: <http://devcoord.deldot.gov> > Checklists.
 - vi. Transit facilities and bus pull offs including existing facilities along with improved or proposed facilities, if recommended by the local land use authority.
 6. To facilitate review of the plans, the new entrance(s) shall be staked in the field in order to determine the feasibility of the design based on the following procedures:
 - i. Place two wooden stakes at the entrance. The stakes shall be visible 24 inches to 36 inches above the ground. The stakes shall be placed 24 feet apart, and as close to the roadside property line as possible, while being clearly visible from the road. The stakes shall not be set closer than five feet from the edge of pavement.
 - ii. Tie ribbons or apply yellow paint to the top of stakes to make them clearly visible.

- iii. Write the property owner's last name on each stake.

3.4.2.1 Commercial Or Major Residential Subdivisions - Record Plan Content

The following items are required by DelDOT to be included on the Record Plan:

- A. A title block containing:
 1. Name of proposed development
 2. Name of town/hundred and county
 3. Maintenance number of highway being accessed
 4. Graphic Scale (1" = 30' preferred, 1" = 20' acceptable)
 5. Date
 6. Name, address, and telephone number of owner and engineer or surveyor preparing plan
 7. Seal of engineer or surveyor (Delaware License required)
 8. Owner's signature (for final approval)
- B. A data block containing:
 1. Gross acreage of property
 2. Zoning
 3. Present use
 4. Proposed use
 5. Sewer provider
 6. Water provider
 7. Tax Parcel Number
 8. Total number of lots, existing and proposed
 9. Posted speed limit on frontage road(s)
 10. Proximity to identified Transportation Improvement Districts (TID)
 11. Investment Level Area as defined by the State Strategies for Policies and Spending maps (for major or commercial subdivisions only). Maps are available at: <http://deldot.gov/Programs/gate/index>
- C. Existing Features

All Record Plans for commercial or residential subdivision access onto a State-maintained roadway must be at scale and clearly show the location of the following items according to Figures 3.4.2-b, 3.4.2-c and 3.4.2-d:

 1. Existing entrances showing dimensions, location and spacing of any entrances. This applies to each side of the entrance and shall include entrances on both sides of the road. If there are no entrances within the required distance, then show the distance to the nearest entrance. The type of use served by each entrance shall be noted as well as any restrictions in movements.
 2. Identification of the existing and proposed land uses adjacent to and opposite the site
 3. Existing rights-of-ways, easements or reservations
 4. Buildings and other structures may need to be shown and labeled, as determined by DelDOT based upon field conditions
- D. Proposed Features:
 1. Proposed land uses

DelDOT Development Coordination Manual

2. Proposed entrance locations
3. Label any necessary right-of-way or easement dedication or reservation
4. New street names (if applicable)
5. New street right-of-way widths (if applicable)
6. Future interconnection note (if applicable)
7. Dimensions of relevant physical features
8. Existing and proposed cross-access easements (if applicable)

E. Notes:

1. Note outlining the date a traffic impact study was completed and requirements submitted to the local land use agency (if applicable)
2. Note outlining any transportation improvements required
3. Note specifying the maintenance of proposed subdivision streets (if applicable, see <http://devcoord.deldot.gov> > Quick Links > DeIDOT Notes)
4. General notes (<http://devcoord.deldot.gov> > Quick Links > DeIDOT Notes)

F. Traffic Information:

1. Traffic generation (from ITE Traffic Generation Manual) and distribution for the site
2. Truck percentage for the site
3. Existing and buildout volumes for the site (daily and peak hour) (*DelDOT will provide projected volumes upon request*)
4. Existing and projected (10-year) directional distribution volumes for the adjacent roadway (*DelDOT will provide projected volumes upon request*)
5. Posted speed limit
6. Design vehicle - Applicant will be required to coordinate with owner/developer to determine correct design vehicle for site usage.

If a commercial project is choosing to utilize the Record Plan –RED process, the following items are required on the Record Plan – Red: Items 3.4.2.1 A, B(1, 2, 3, 5-11), C, E.

The following items are required on the Site Plan submitted as part of the Record Plan – RED process: Items 3.4.2.1 A, B, D, E, F.

Figure 3.4.2-a Traffic Generation Diagram

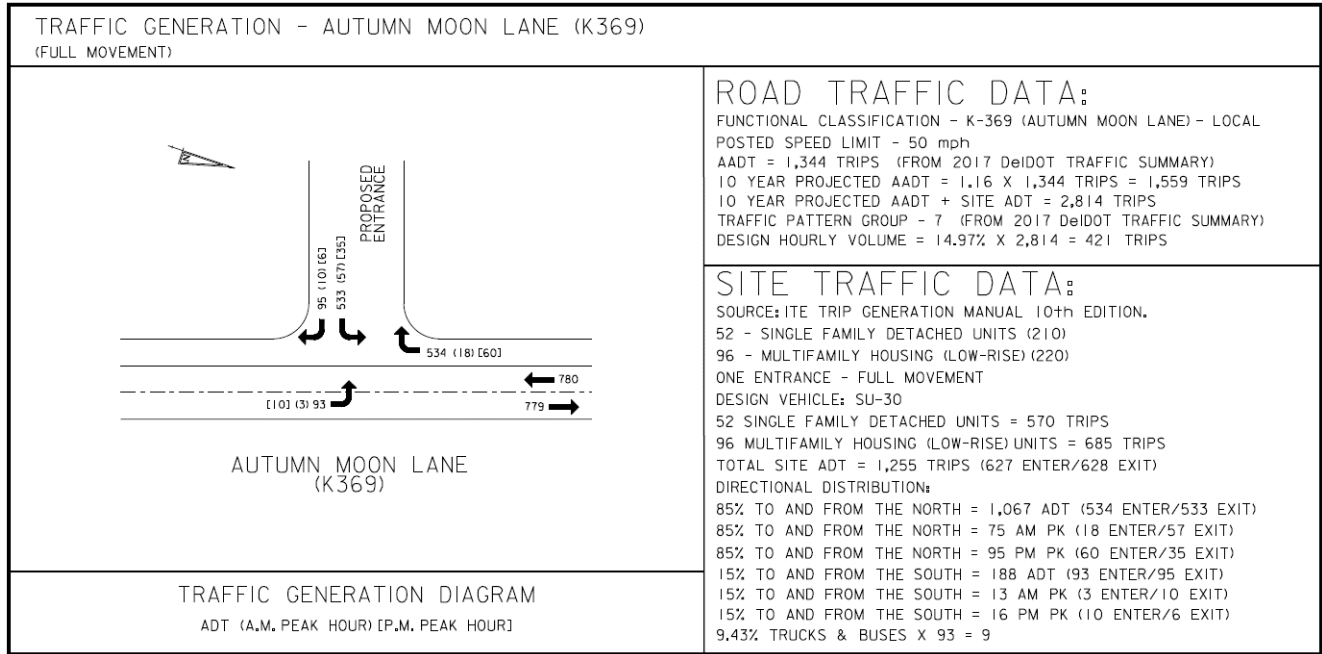

Figure 3.4.2-b Requirements for Adjacent Existing Features on Record Plans

Roadway with Posted Speed Limit	Show Features Within*
35 mph or less	300 feet
40 – 45 mph	450 feet
50 – 55 mph	600 feet

*Distances measured from site access or a minimum of 200 feet beyond a site's property lines whichever is greater. Drawing shall be to scale.

Figure 3.4.2-c Requirements for Adjacent Existing Features on Record Plan – Direct Frontage

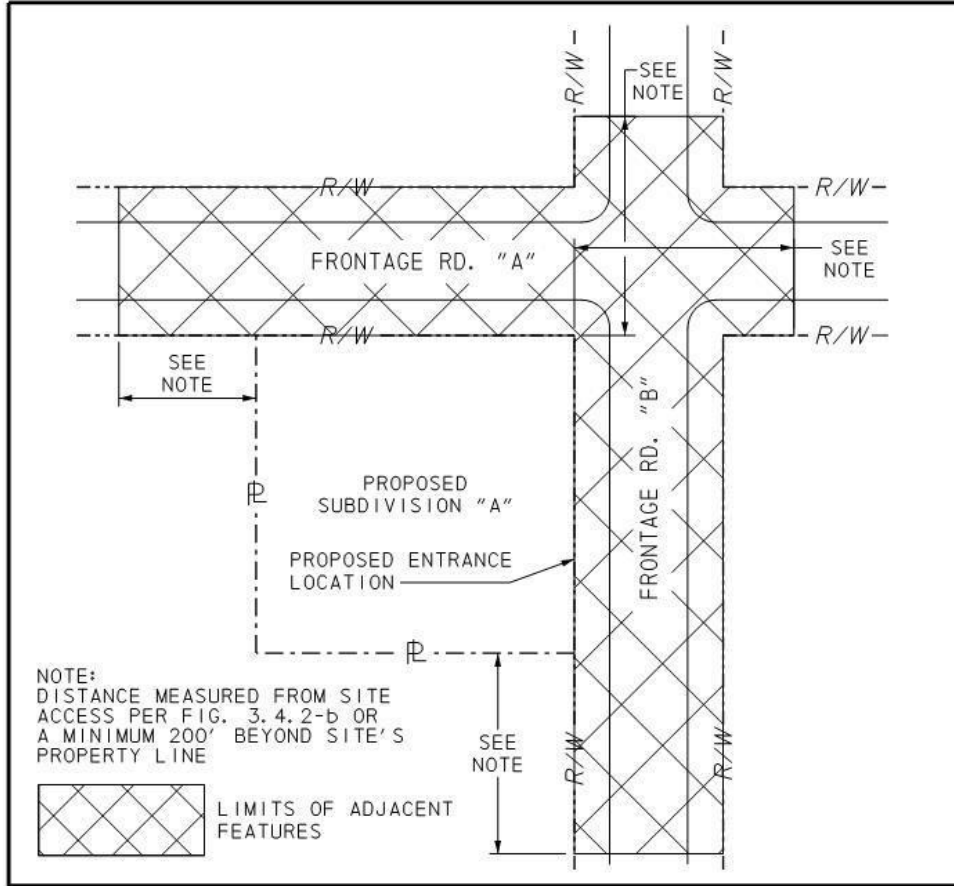
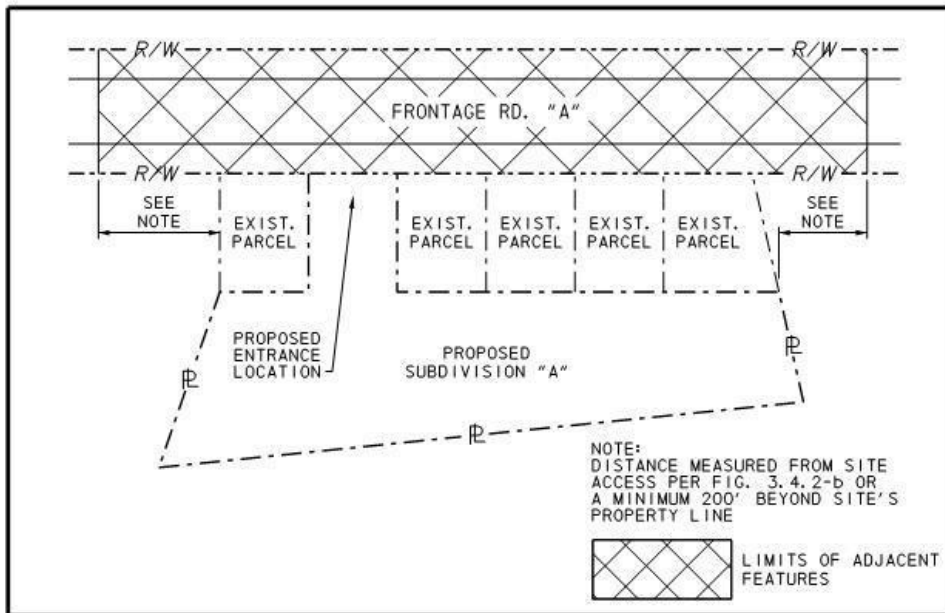

Figure 3.4.2-d Requirements for Adjacent Existing Features on Record Plan – Limited Frontage



3.4.3 Commercial or Major Residential Subdivisions - Site Entrance

Intersections of subdivision streets with state-maintained roadways are to be designed in accordance with this *Development Coordination Manual*. The location and design of entrances and exits onto state-maintained roads are governed by the criteria established in Chapter 1 and the detailed design elements listed in Chapter 5. Considerations must be given to the location of the entrance to ensure applicable guidelines listed in Section 5.2 are addressed.

3.5 CONNECTIVITY

This section provides connectivity requirements for all development projects having access to state roads or proposing DelDOT maintained public roads for subdivisions. Private or municipal streets should follow the local land use agency's requirements for connectivity.

3.5.1 Connectivity - Requirements

The Record Plan shall be developed to provide or incorporate a street system that will allow access to and from the proposed development, as well as access to all existing and future development within the immediate area. Proposed residential and commercial development parcels shall be designed to connect to existing linkages on adjacent parcels. The Record Plan shall attain the following connectivity objectives:

- A. Encourage pedestrian and bicycle travel by providing short, direct public routes to connect residential uses with nearby existing and planned commercial services, transit facilities, schools, parks and other neighborhood facilities.
- B. Provide bike and pedestrian access-ways or walkways on public easements or right-of-way when full street connections are not possible, at spacing that shall be consistent with the provisions of Section 3.5.4 except where prevented by topography, barriers such as railroads or freeways, or environmental constraints such as tax ditches, major streams and rivers.
- C. Identify and, where possible, create opportunities to extend and connect local streets in previously developed areas.
- D. Serve a mix of land uses on contiguous local streets.
- E. Consider narrow street design alternatives that feature total right-of-way of no more than 50 feet, including pavement widths of no more than those noted in Figures 5.5.2-a through 5.5.2-c of Chapter 5, sidewalk widths of at least five feet and landscaped pedestrian buffer strips that include street trees. In certain situations or in urban environments, DelDOT may require sidewalks wider than 5 feet.
- F. Limit the use of cul-de-sac designs and closed street systems to situations where topography, pre-existing development or environmental constraints prevent full street connections. Include a street design that accommodates and promotes multi-modal access (buses, bicycles and pedestrians) to land uses, improves area circulation and reduces travel distance.

3.5.2 Transportation Networks and Connections

- A. The Applicant shall also identify on the Record Plan:
 - 1. The location and spacing of existing or proposed stub streets that intersect with or connect to the Applicant's proposed development site.

2. The location of any existing or proposed Type III subdivision street, local or higher order road within the adjacent development, whether or not such road would connect to the Applicant's proposed development site.
 3. The location and spacing of existing or proposed bicycle and pedestrian connections, including bicycle striping on roadways, sidewalks, and shared-use paths.
- B. The proposed transportation network for the Record Plan shall be determined based on the following criteria:
1. Proposed local or higher order roadways and connections identified in an Approved Local Transportation Circulation Plan shall be included in the transportation network. DelDOT shall determine if an Approved Local Transportation Circulation Plan is complete or if it should be supplemented to accommodate the proposed development or for modifications to the project area since the approved plan was completed. Planned roads that have not yet been constructed shall be indicated.
 2. Local and higher order DelDOT road spacing at distances not exceeding 2,640 feet (1/2 mile)
 3. The Applicant may be required at DelDOT's discretion to provide direct connection to local or higher order roads that abut or traverse the Applicant's property unless DelDOT determines that a connection is undesirable.
 4. A portion of a local or higher order road may need to be constructed through the Applicant's site based on the spacing of existing roadways or of roadways proposed in Approved Local Transportation Circulation Plans.

3.5.3 DelDOT Subdivision Streets

The subdivision street system shall provide multi-modal access and multiple routes from each development to existing or planned neighborhood centers, parks and schools, without requiring the use of local and higher order roads, unless DelDOT has determined that doing so is infeasible.

The Applicant shall provide a dedication of right-of-way for all proposed roadway segments on its Record Plan in accordance with Figure 3.2.1-a and shall construct all proposed roadway segments unless DelDOT determines such construction to be unnecessary.

Type I and Type II Subdivision Streets, Industrial Streets

The Applicant shall show on the Record Plan and, if not currently existing, construct streets in the following fashion:

- A. *Residential, Commercial and Mixed-Use Development or Redevelopment* - Type I and Type II Subdivision or, if applicable, Industrial street connections shall be spaced at intervals of no more than 1,000 feet as measured from the near side right-of-way line, unless DelDOT determined that doing so is infeasible.
- B. *High Density Residential or High Density Mixed Use Development* - Subdivision street connections at intervals of no more than 500 feet shall be provided in areas planned for the highest density residential and mixed-use development. Where the street pattern in the area immediately surrounding the site meets this spacing interval, the existing street pattern should be extended into the site.
- C. *Large Lot Subdivisions* - The above provisions notwithstanding, subdivisions with lot sizes of one acre or more may use a Type I and Type II subdivision street spacing of up to 1,320 feet.

Type III Subdivision Streets

A portion or portions of Type III Subdivision streets may need to be constructed through the Applicant's site based on the spacing of existing roadways, and of roadways proposed in Approved Local Transportation Circulation Plans.

3.5.4 Connectivity - Bicycle and Pedestrian Spacing

Existing and proposed bicycle and pedestrian connections shall also be shown on the Record Plan as provided in this section. A fee in lieu of constructing connections may be appropriate in some instances as determined by DelDOT.

3.5.4.1 Bicycle Compatibility

Bicycles shall be accommodated on all subdivision and higher order roads within the proposed development in accordance with applicable standards such as those provided in AASHTO's *Guide for the Development of Bicycle Facilities*.

3.5.4.2 Shared-Use Paths and Sidewalks

- A. **Frontage Roadways** – This section defines the Shared-Use Path (SUP) and/or Sidewalk (SW) requirements that apply when the commercial or major residential subdivision has frontage along State maintained: Arterial, Collector, and/or Local roadways. If DelDOT requires such facilities, DelDOT will determine whether the facility should be a sidewalk or a shared-use path and the owner or applicant shall be required to construct a SUP/SW or to provide the fee payment in lieu of construction. Specific requirements related to the warrants for a SUP/SW are as follows:
1. SUP/SW construction shall be required for all projects that generate a total of 2,000 Average Daily Trips (ADT) or more, and are requesting an Entrance Plan Approval (EPA) or Entrance Permit in all Investment Level Areas as defined by the State Strategies for Policies and Spending maps.
 2. SUP/SW construction shall be required for all projects requesting an EPA or Entrance Permit in all Investment Level I and Investment Level II Areas as defined by the State Strategies for Policies and Spending maps. (If a physical impossibility exists, then the SUP/SW fee in lieu of construction shall be paid.)
 3. SUP/SW shall be required for all projects requesting an EPA or Entrance Permit in all Investment Level III and Investment Level IV Areas as defined by the State Strategies for Policies and Spending Maps if the project abuts an existing facility. If the project does not abut an existing facility it will be at the Subdivision Engineer's discretion. No fee in lieu of construction is required if the SUP/SW facilities are not required as per the Subdivision Engineer's determination.
 4. SUP/SW fee in lieu of construction shall be based on current accepted rates. The Shared-Use Path and Sidewalk Fee Calculation Form, (available on DelDOT's website http://www.deldot.gov/information/business/subdivisions/SUP_and_SW_Fee_Calc_Form.docx), shall be used to calculate the amount.
 5. If a non-profit organization (school, fire-company, church etc.) receives funding for the construction of the required SUP/SW from the Community Transportation Fund (CTF) then the SUP/SW will either be constructed at that location through the applicant's construction process under a third party agreement or at a future date through the Department's Capital Transportation Program (CTP).
 6. The fee in lieu of construction will be utilized in accordance with the Department's SUP/SW fund procedure.
 7. If any of the criteria above is to be waived, it will require the Director of Planning's approval.
- B. **Internal Development and Subdivision Streets** – This section defines the SUP/SW requirements that apply within residential subdivisions, redevelopment projects and commercial or mixed-use

developments. The owner or applicant shall be required to provide items on the Record Plan and/or to construct a SUP/SW for development projects in accordance with the following warrants:

1. The Applicant shall provide a SUP/SW along both sides of subdivision streets where the development has a net density of three dwelling units or greater per acre.
 2. The Applicant shall provide a SUP/SW along both sides of development project streets where the development has access to transit or other local destinations or is of such a nature that it is reasonable to assume, as determined by DelDOT, that it will attract pedestrians.
 3. The Applicant shall provide a SUP/SW along at least one side of a street that does not meet the requirements in paragraph 1 or 2 or where there are physical or environmental constraints that make sidewalks on both sides of a street impractical.
- C. Off-Network Trails – This section defines the SUP/SW requirements that apply, when constructing a SUP/SW which does not fully match the location and placement criteria of Section 3.5.4.2.A or 3.5.4.2.B. Off-Network Trails may connect existing or proposed SUP/SW facilities by passing through the development project, and typically will not follow internal streets. The owner or applicant shall construct Off-Network Trails SUP/SW in accordance with the following warrants:
1. The proposed physical location and Permanent Easement (PE) for the facility is required to be shown (on the Record Plan) and recorded via separate deed or recorded plat. The intent is to allow current or future land owners and adjoining land owners the opportunity to understand the location and nature of any such Off- Network Trail.
 2. The location of any such Off-Network Trail/facility is required to be situated based upon guidance from the DelDOT Planning Section’s Bicycle and Pedestrian coordinators.
 3. The approved and recorded plans shall include the following note: “Initial construction, ongoing maintenance and long term funding associated with any Shared-Use Path (SUP) and/or Sidewalk segments and their associated Permanent Easements shall be the responsibility of the developer, the property owners or both associated with this project. The State of Delaware assumes no responsibility for the future maintenance of these Shared-Use Path (SUP) and/or Sidewalk segments and their associated Permanent Easements.”

Figure 3.5.4.2-a Sidewalk Designs

4. SUP/SW construction for development projects that are responsible for the creation of such Off-Network Trails shall coordinate the timing and/or phasing of trail construction during the process of seeking an Entrance Plan Approval (EPA) from the Development Coordination Section. Unless agreed to by the Development Coordination Section of DelDOT as a condition of approval, the Shared- Use Path (SUP) and/or Sidewalk construction shall begin concurrent with initial site-entrance construction, and be complete prior to 25% occupancy or leasing of the development project.

D. Shared-use paths and sidewalks shall be constructed in accordance with Chapter 5 of this manual and shall meet the Pedestrian Accessibility Standards.

E. Shared-use paths and sidewalks shall be separated from the edge of road, pavement, driveways, parking lots, and site entrances in accordance with Chapter 5 of this manual. Where a sidewalk is planned to adjoin the pavement edge of parking lot areas, such sidewalk shall be grade-separated from the parking lot surface by at least a six-inch vertical face curbing and shall be at least eight feet wide unless concrete wheel stops, bollards, landscaping, minimum 3' wide grass buffer, or other similar improvements are provided which prevent parked vehicles from obstructing the sidewalk. See Figure 3.5.4.2-a.

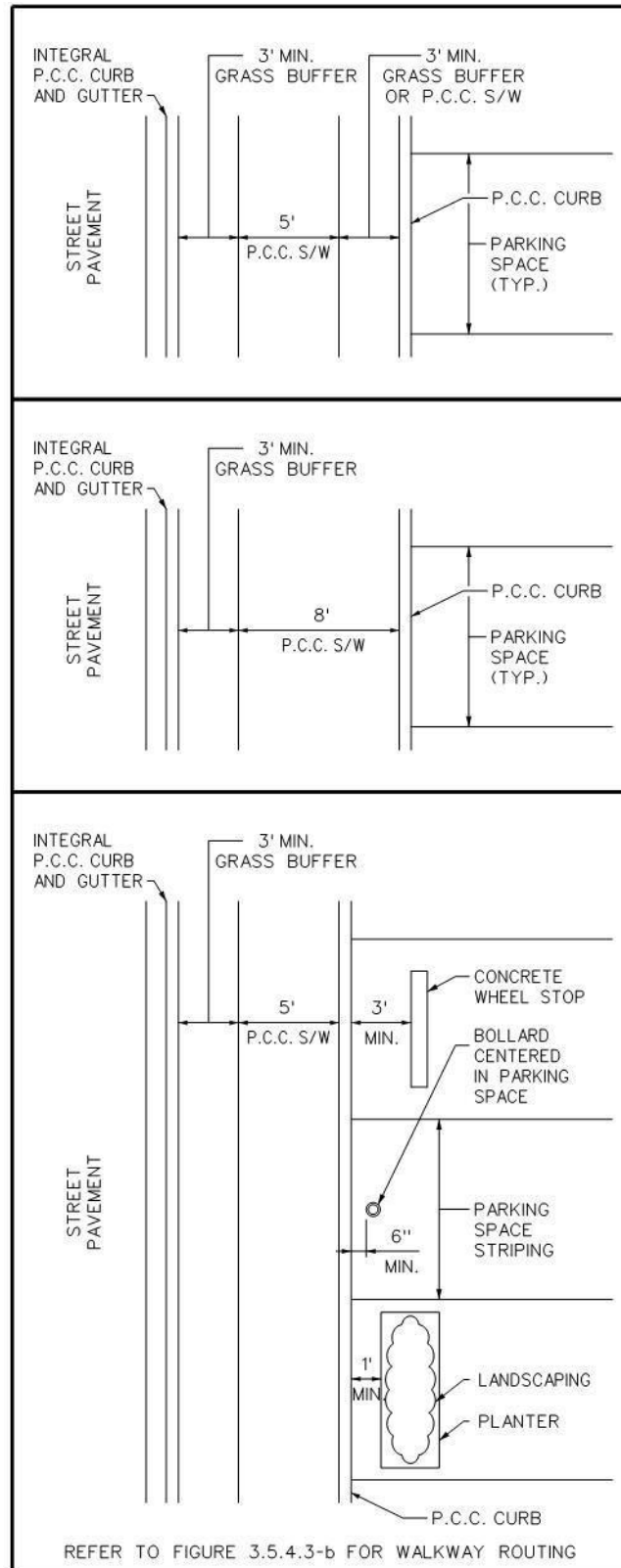

F. Shared-Use Path and Sidewalk Termination Points and Road Tie-ins shall be designed in accordance with the requirements below and the PAS for shared transportation paths, and additional requirements as follows. SUP signing and pavement marking is shown in the DE MUTCD and AASHTO publications.

1. When a minimum 5 ft. wide shoulder is present the SUP/SW shall tie into the shoulder at a 45 degree angle with a detectable warning surface (truncated domes) and Type 2 curb ramp, leading to the road connection. The tie-in segment shall match the width of the SUP/SW. The SUP/SW should still dead-end at the property line.
 - i. To promote pedestrian/user safety and minimize the distances that must be traversed within the road/travelway, when no shoulder exists within the project's own frontage, DelDOT may exercise discretion and request the tie-in of the SUP/SW to a turn/deceleration lane. DelDOT will avoid such tie-ins wherever possible, and will consider other practical alternatives. When DelDOT deems it more practical, and sufficient Right-Of-Way (ROW) or Permanent Easement (PE) exist, DelDOT may require that the SUP/SW be extended beyond project's own frontage a minimal distance to tie-in to the shoulder beyond a turn/deceleration lane or to allow for a connection to an adjacent SUP/SW facility or driveway.

Figure 3.5.4.2-b Sidewalk/Shared Use Path Tie-in

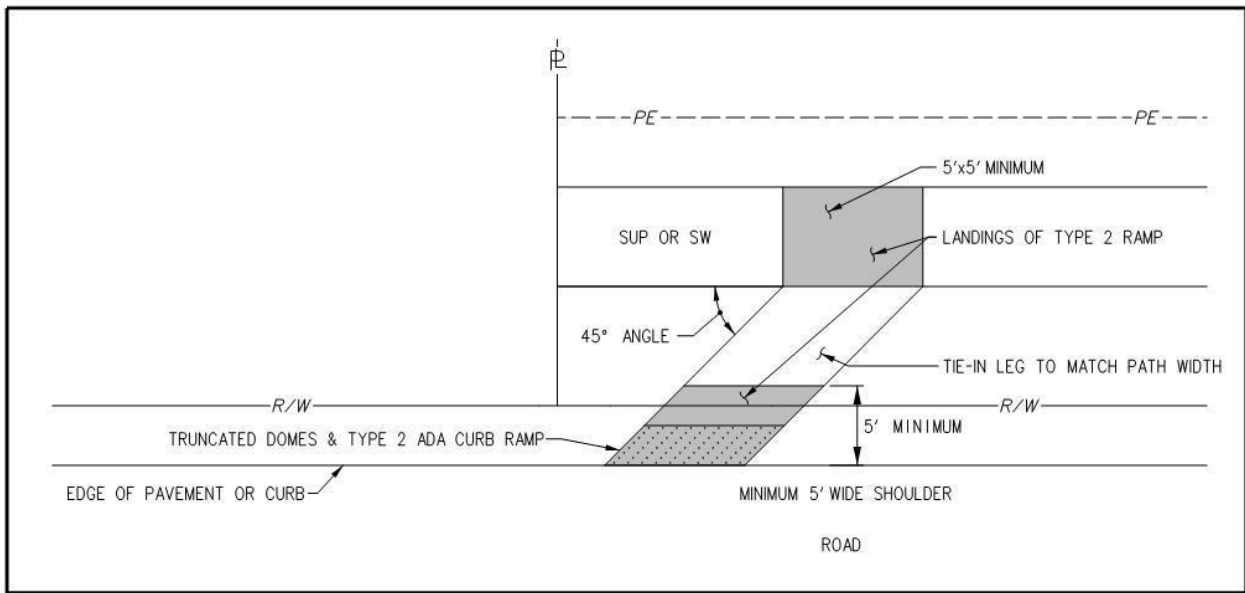

2. Where a ditch must be crossed to tie-in to the roadway, a 2 ft. graded SUP/SW user recovery area with a slope of 6H:1V or flatter shall be provided adjacent to the path followed by a maximum 3H:1V slope to the invert of pipe or swale.
3. When no shoulder is present, no connection to the roadway shall be established. The SUP/SW shall terminate at the property line, other facility or DelDOT determined location to promote a safe termination.

If a property is developed adjacent to a parcel with a SUP/SW stub and road tie-in, it shall be the responsibility of that Developer to remove the road tie-in on the adjacent property once the main line connection is made. This requirement should be identified during the plan review process and a note shall be placed on the Record Plan defining the Developer's responsibility, ([http:// www.deldot.gov/ information/ business/ subdivisions/ DeIDOT_Development Coordination Plan Sheet Notes.doc](http://www.deldot.gov/information/business/subdivisions/DeIDOT_Development_Coordination_Plan_Sheet_Notes.doc)). Physical removal of the SUP/SW road tie-in on the adjacent property shall be at DeIDOT's discretion.

3.5.4.3 Walkways

Non-residential developments shall provide a system of internal pedestrian connections to encourage safe and convenient pedestrian movement within the site. These pedestrian connections, known as walkways, shall also link the site with the public street sidewalk, transit facilities and shared-use trail system, where they exist.

- A. *Locating Walkways* - A walkway into the site shall be provided for every 330 feet of street frontage unless otherwise directed by DeIDOT. A walkway should also be provided to any sidewalk or access-way abutting the site. See Figure 3.5.4.3-a.

Figure 3.5.4.3-a Locating Walkways

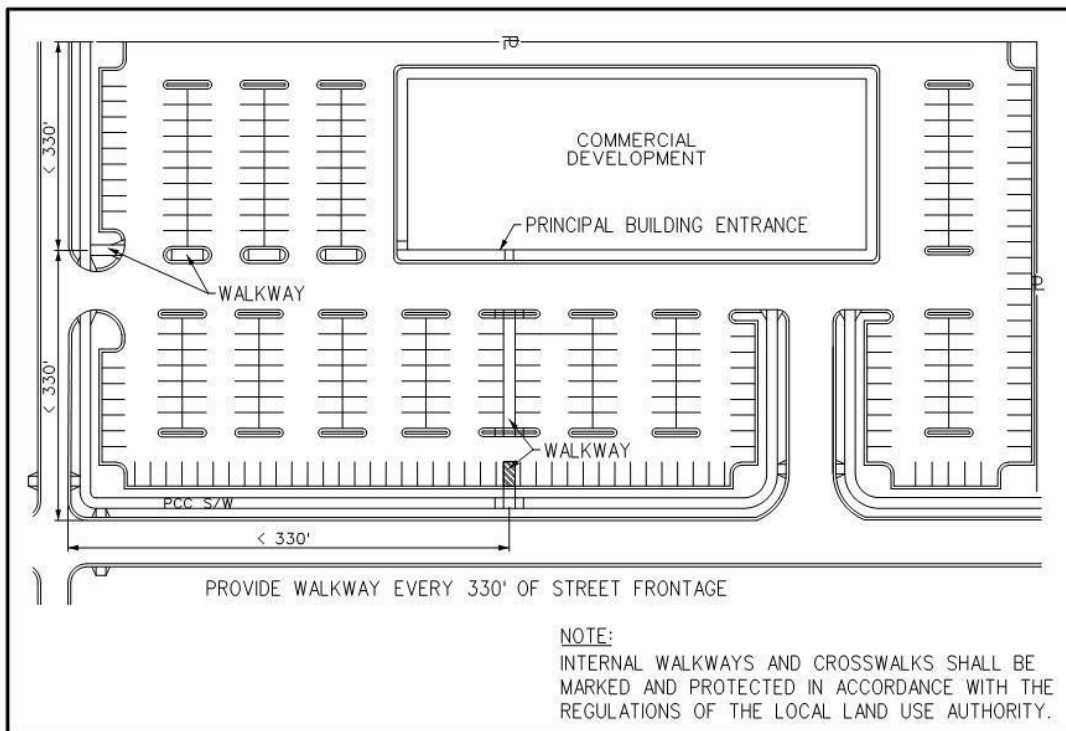

- B. *Walkway Connections* - Walkways should connect building entrances to one another and from building entrances to adjacent public streets and existing or planned transit facilities. On-site walkways should connect with walkways, sidewalks, bicycle facilities, alleyways and other bicycle or pedestrian connections on adjacent properties. DelDOT may request connections to be constructed and extended to the property line at the time of development.
- C. *Walkway Design* - Walkways should be designed according to PAS. Walkways bordering parking spaces should be at least eight feet wide unless concrete wheel stops, bollards, landscaping, or other similar improvements are provided which prevent parked vehicles from obstructing the walkway. Ramped walkways should be provided where necessary to afford a reasonably direct route and should conform to DelDOT standards. Walkways should be differentiated from parking areas and circulation aisles by changes in grade, different paving material, landscaping or other similar method. See Figures 3.5.4.3-b and 3.5.4.3-c.

Figure 3.5.4.3-b Walkway Routing

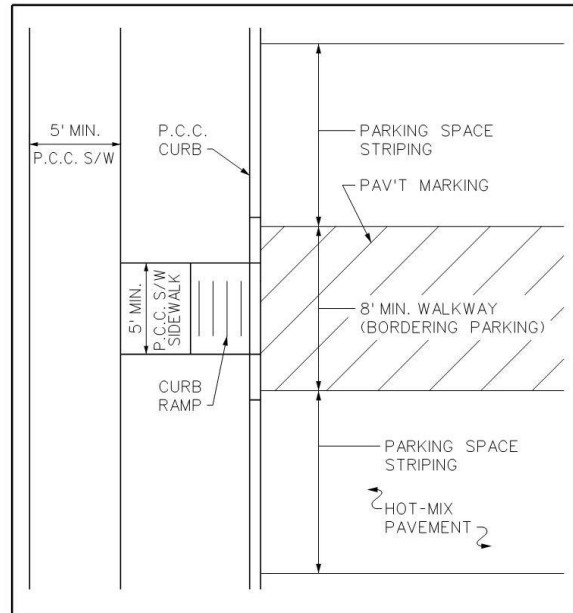
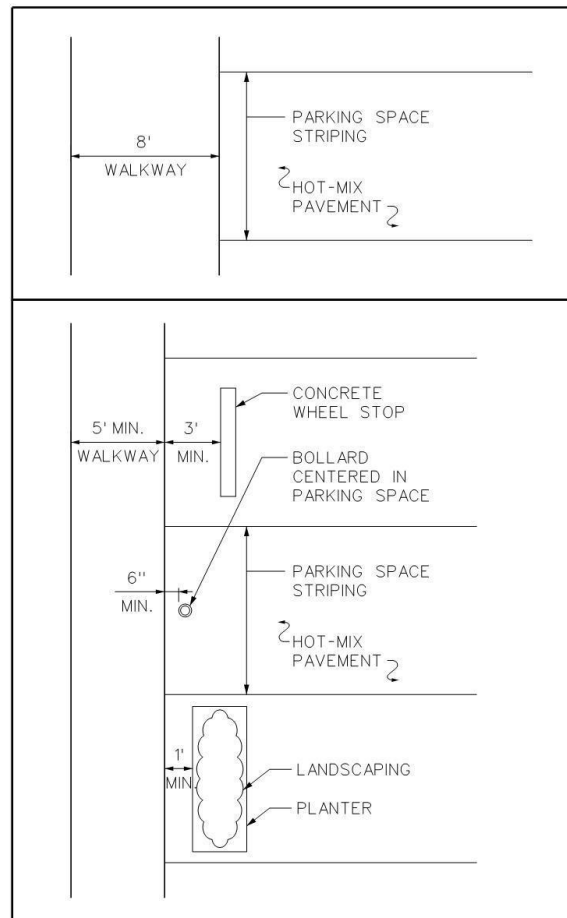

Figure 3.5.4.3-c Walkway Designs



3.5.4.4 Access-ways

Access-ways shall be used to provide bicycle and pedestrian passage between streets and/or existing or proposed trails when the spacing between streets is inadequate to accommodate convenient pedestrian and bicycle travel. Access-ways are similar to walkways constructed in commercial or mixed use developments but are generally wider so as to accommodate bicycle traffic in residential areas. A shared-use path may be identified within a development project as an access-way however access-ways will typically carry less traffic, be narrower and require less total right-of-way than a shared-use path. Access-ways differ from sidewalks in that they do not generally run along the right of way of roads and streets.

Access-ways shall be provided as part of all new developments and redevelopments where the net dwelling unit density is greater than 1 dwelling unit per acre.

Access-ways shall be provided for pedestrians and bicycles on recorded open space where full street connections are not possible, with spacing between full street and access-way connections of no more than 660 feet, except where prevented by topography, barriers such as buildings, railroads or freeways, or environmental constraints such as major streams and rivers (all collectively to be called “constraints”).

- A. Access-way Width and Access Width - The width of the recorded open space for access-ways must be sufficient to accommodate expected users, and provide a safe environment, taking into consideration the characteristics of the site and vicinity, such as the existing street and pedestrian system improvements, existing structures, natural features, and total length of the access-way connection. Access-ways shall be set at a minimum width of 8 feet, with a minimum recorded open space width of 18 feet. A minimum 2 foot clearance should be provided to lateral obstructions such as shrubs or trees. In addition, the DE MUTCD requires a minimum 2’ clearance from post mounted signs. See Figure 3.5.4.4-a. Access-ways within a subdivision street system shall be provided as follows:
1. Where any block of the subject street that is longer than 660 feet as measured from the near side right-of-way line of an intersecting street to the near side right-of-way line of another intersecting street, an access-way shall be required through and near the middle of the block. See Figure 3.5.4.4-b.
 2. Where any block of the subject street is longer than 1,320 feet as measured from the near side right-of-way line of an intersecting street to the near side right-of-way line of another intersecting street, two or more access-ways may be required through the block. See Figure 3.5.4.4-c.
 3. Where a street connection is not feasible, one or more new access-ways to the following shall be provided as a component of the development: an existing transit stop, a planned transit route as identified by DTC and/or DelDOT, shopping center or a community facility. The access-way shall be made as direct as possible.
 4. DelDOT may require an access-way to connect from one cul-de-sac to an adjacent cul-de-sac or street. See Figure 3.5.4.4-d.
 5. In a proposed development or where redevelopment potential exists and a street connection is not proposed or possible, one or more access-ways may be required to connect a cul-de-sac to public streets, to other access-ways, or to the project boundary to allow for future connections.
 6. A new access-way to a community facility shall be provided as a component of a development proposal if the addition of an access-way would reduce walking or bicycling distance by at least 50 percent over other available sidewalks, walkways or access-ways and the reduced walking or bicycling distance is greater than 660 feet. See Figure 3.5.4.4-e.
- B. Access-way Design Standards – Access-ways shall be as short as possible and wherever practical, straight enough to allow one end of the path to be visible from the other.

Access-ways shall be located to provide a reasonably direct connection between destinations via pedestrian and bicycle travel.

Access-ways through parking lots should be physically separated from adjacent vehicle parking and parallel vehicle traffic through the use of curbs, car stops, landscaping buffer, trees, lighting, and such other methods as may be desirable, if not otherwise provided in the parking lot design. See Figures 3.5.4.3.b and 3.5.4.3.c.

Where possible, access-ways shall converge with streets at traffic-controlled intersections for safe crossing.

Figure 3.5.4.4-a Access-way Width

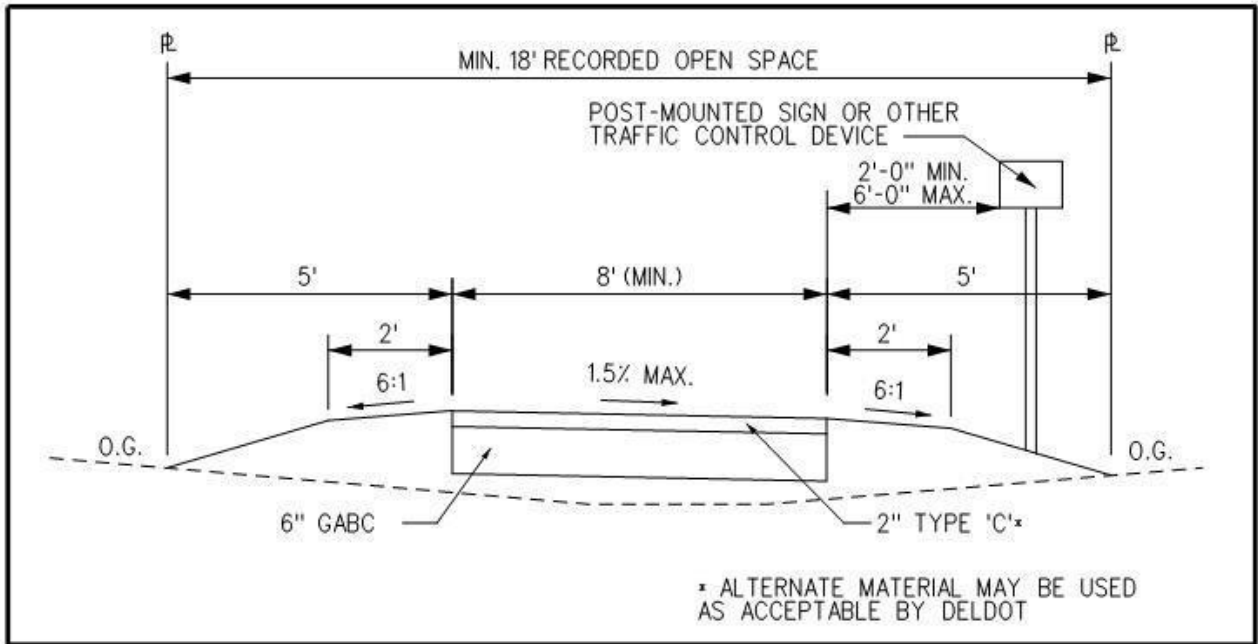

Figure 3.5.4.4-b Access-ways – 660' < Block Length < 1320'

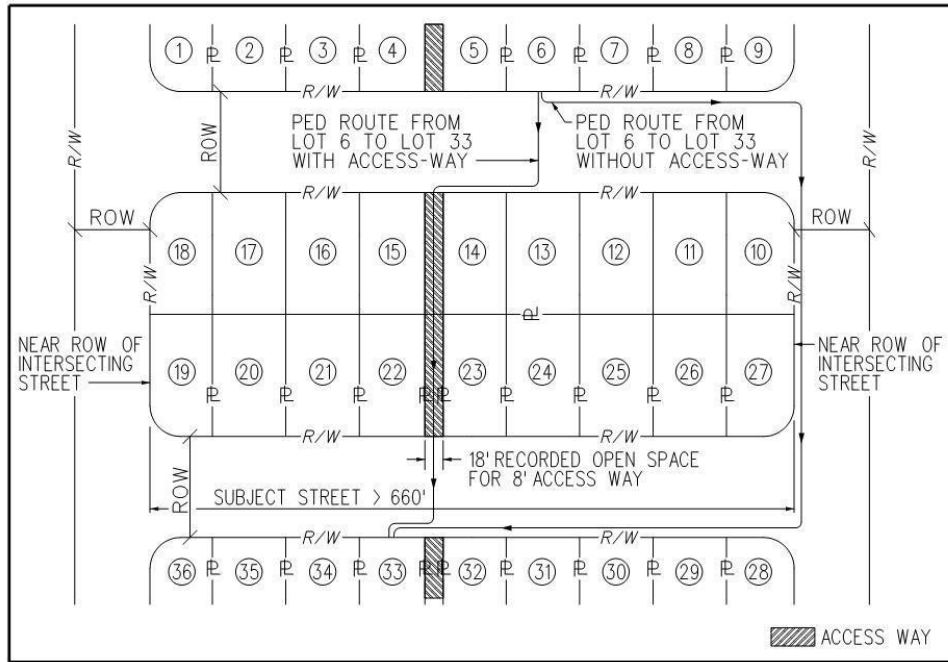

Figure 3.5.4.4-c Access-ways – Block Length > 1,320'

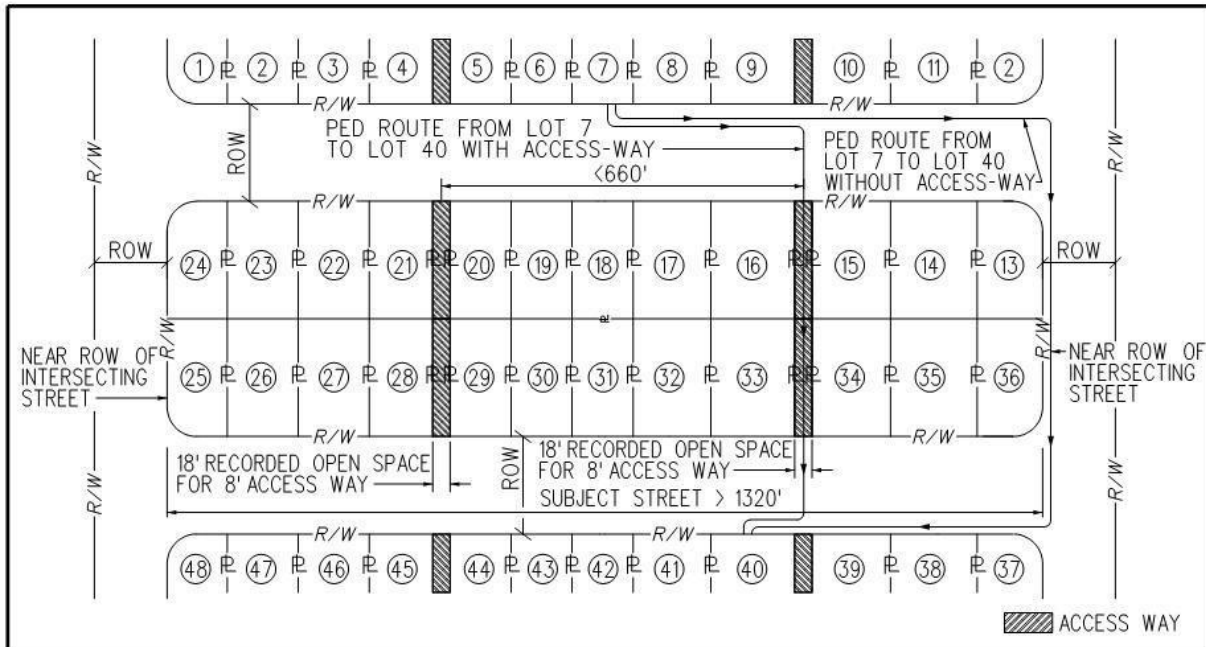

Figure 3.5.4.4-d Access-ways – Cul de Sac Connection

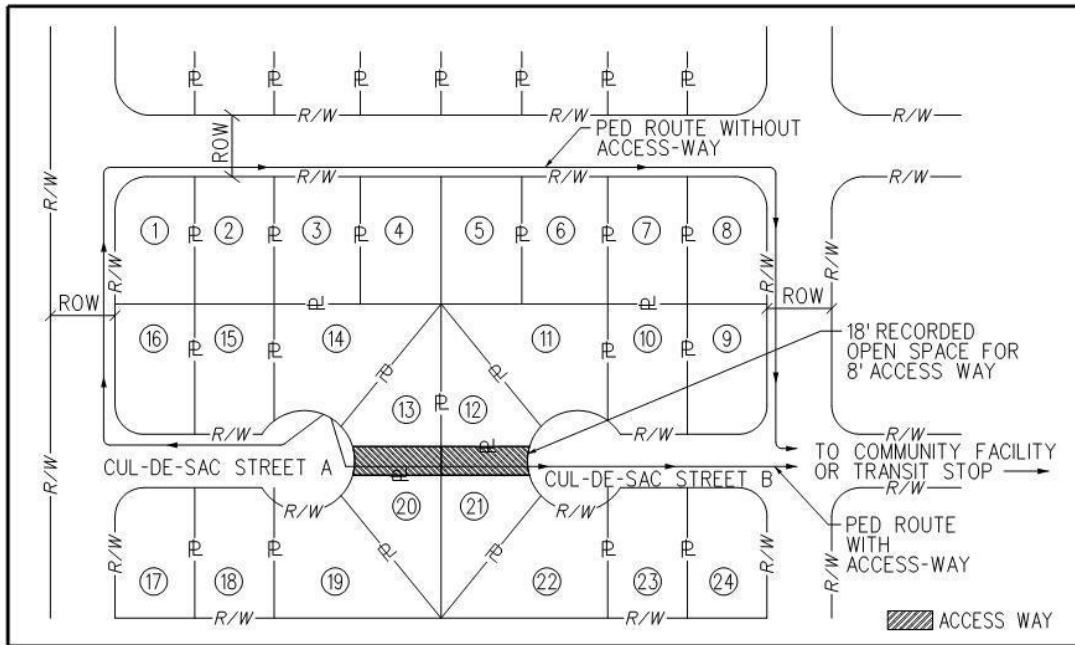
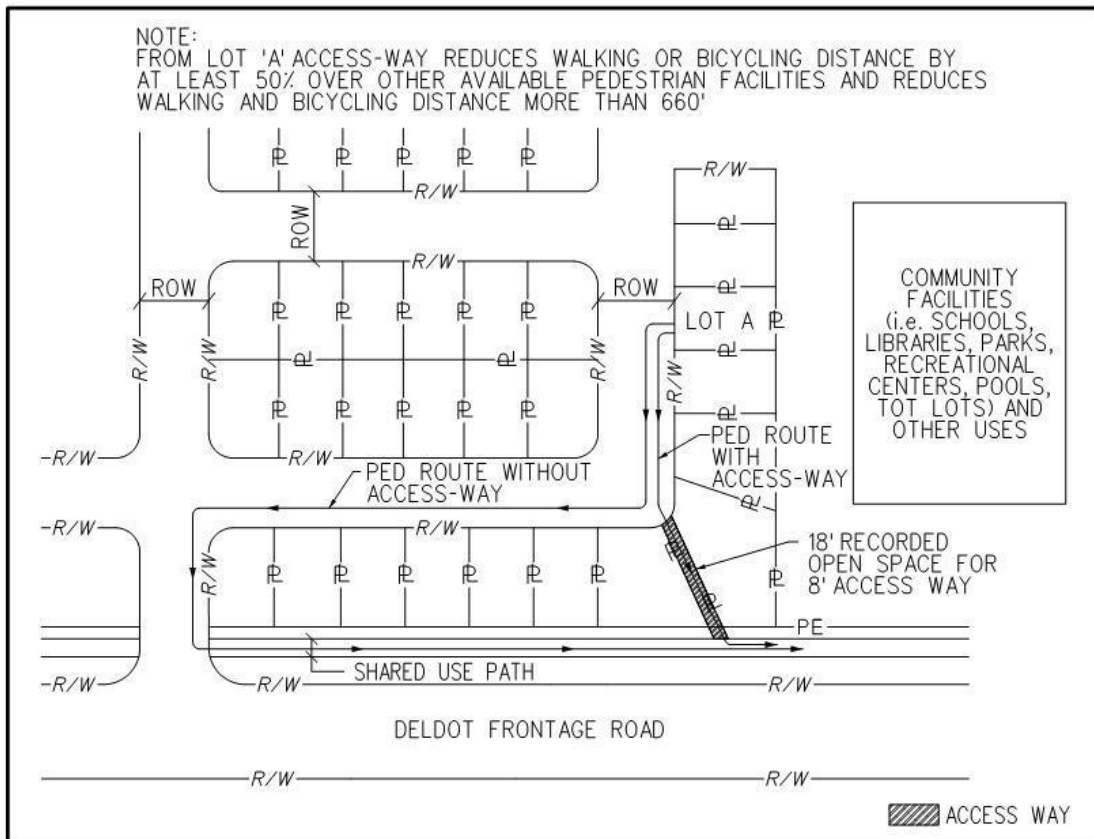

Figure 3.5.4.4-e Access-ways – Community Facilities



3.5.4.5 Roadway Crossing by Bicycles and Pedestrians

The Applicant shall be required to install marked crosswalks between curb ramps for the purpose of delineating pedestrian and bicycle street-crossing locations in the following instances:

- A. Across subdivision streets where the subdivision street intersects a frontage road. Crosswalks may also be required across the frontage road at DelDOT's discretion
- B. At all signalized intersections adjoining the development site
- C. At key locations to provide marked street crossing access to active or passive parkland and open space areas, schools, playgrounds, neighborhood shopping centers, transit and similar pedestrian destinations within and adjoining the development site
- D. *Pedestrian Refuge* – If at all feasible, pedestrian refuge areas shall be constructed across roadways of 4 or more travel lanes at key locations where a marked crosswalk is to be installed.

3.5.5 Connectivity - Transit Facilities

Existing and proposed transit stops, shall be shown on the Record Plan with applicable bicycle and pedestrian connectivity. These facilities may include passenger shelters, bicycle parking, landing pads, bus pull-offs, walkways to the transit stop location, or some combination thereof, as required by DTC or DelDOT, in consultation with the applicable land use authority.

3.5.5.1 Industrial, Institution, Retail, and Office Developments

DelDOT or DTC may require: industrial uses, office, institutional uses, or retail establishments; larger than 150,000 s.f. to provide either a transit stop on-site or adjacent to the site, or a pedestrian connection to an existing transit stop.

In such cases, pedestrian connections shall be made to any transit facility within 1,320 feet of the boundary line of a site. The connections should take the most practical direct route. Users should be able to see the ending of the connection from the entrance point, if possible.

If transit service exists along the frontage of the development, or if, after consultation with DTC, it is determined that the development is a feasible candidate for transit service, and there is no existing transit stop within 1,320 feet of the site, pedestrian routes and transit facilities shall be designed to support transit use through provision of improvements.

3.5.5.2 Residential Developments

- A. *School and Transit Bus Stop Requirements* – All subdivision and residential site development proposals involving more than 50 dwelling units shall be required to designate and reserve locations for transit and school bus stop accommodations within and/or adjacent to the proposed development, as directed by DelDOT or DTC. If these accommodations are adjacent to the proposed development, pedestrian connections may be required, taking the most practical direct route.

- B. *School Bus Stop Locations*

The following specifies school bus stop locating procedures:

1. The developer shall notify the local public school district of the location, character and layout of the proposed subdivision or residential site development as early as possible in the plan development process, but in any case, by registered mail no later than 30 days prior to the date of the public meeting at which such proposal will be considered for approval. The purpose of this notification is to offer the local public school district the opportunity to provide input and direction with respect to the most appropriate and serviceable location for school bus stops within the proposed development. If available, the applicant/ developer shall use a School District Notification Form provided by the local jurisdiction developed for this purpose.
2. The local public school district shall have 30 days to provide commentary to both the applicant/developer and to the local jurisdiction with respect to school bus stop provisions. Such commentary shall describe preferred locations of bus stops within and adjoining the proposed development site. Should the local school district choose not to respond within the prescribed period, the development proposal may proceed through the review and approval process.

3.5.5.3 Transit at Mixed Use Developments

To facilitate transit usage and circulation, mixed use developments should provide transit stops at key nodes with easy access to the surrounding thoroughfares. Transit routes through the mixed use development shall be designed to accommodate the technical requirements of bus operations. Transit easements through and within mixed use centers shall be provided as requested by DTC. DTC is involved in the project development process to ensure feasibility and conformance with intended use. The designer should refer to Section 5.3.3 of this manual for more information.

3.5.6 Connectivity - Subdivision Street Intra-Connectivity

In addition to minimum roadway spacing requirements, the Applicant shall demonstrate that the streets within the proposed development will provide adequate connectivity by calculating the project's connectivity ratio.

A. Minimum Required Connectivity Ratio

All Plans shall demonstrate that the proposed subdivision street system will achieve a ***connectivity ratio of 1.4 or greater***.

B. Connectivity Ratio for Phased Development

If a subdivision is planned to be constructed in distinct development phases, then Plan shall demonstrate that the initial phase individually and in conjunction with all subsequent phases, will achieve and maintain the minimum connectivity ratio requirement.

C. Verification of Connectivity Ratio

The Record Subdivision Plat shall reflect compliance with the minimum connectivity ratio requirement. See Figure 3.5.6-a. A calculation sheet reflecting the information in Figure 3.5.6-a shall be submitted.

Figure 3.5.6-a Intra-connectivity – Minimum Required Connectivity Ratio

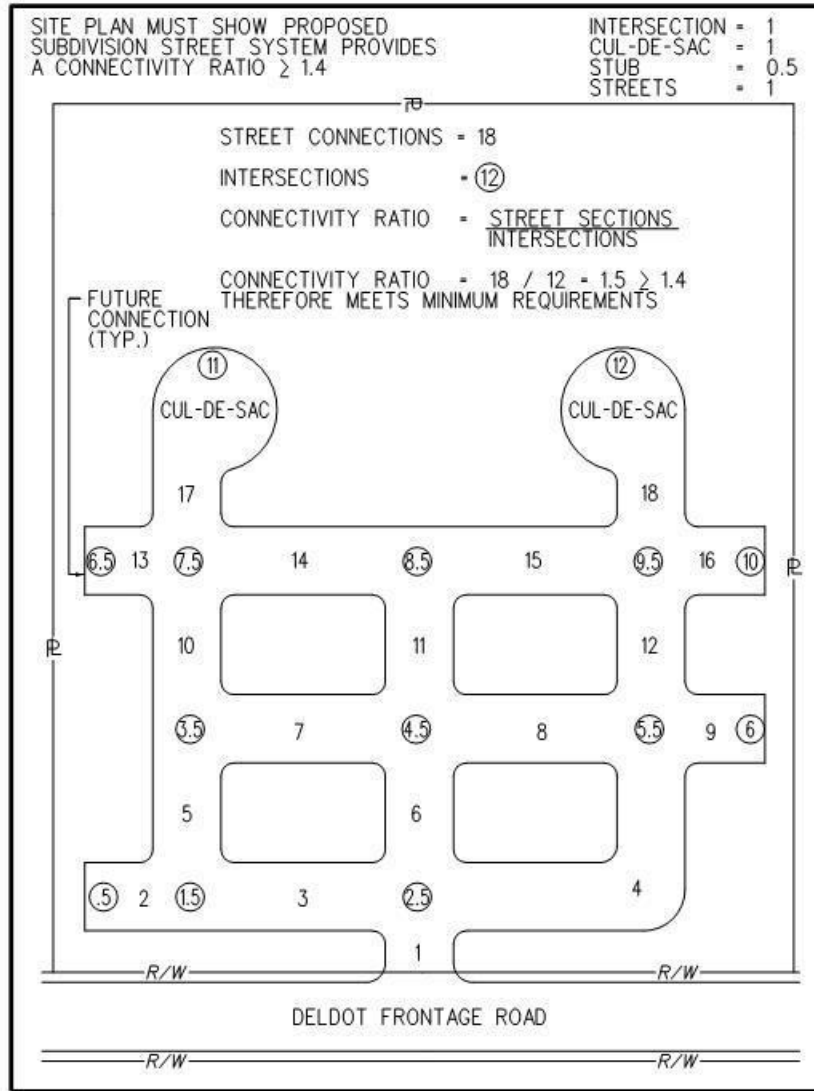

3.5.7 Connectivity - Interconnectivity

Linkages shall be provided among adjoining subdivisions in order to allow convenient and effective travel among neighborhoods. Benefits include ease of access, alternative travel routes for residents, sidewalk networks on local streets and internal circulation routes for service providers such as school buses, transit vehicles, sanitation vehicles, and emergency management personnel.

Where proposed subdivisions abut communities which restrict residents to the age of 55 and over, interconnections shall be regulated by the provisions of 17 Del.C. §531.

3.5.7.1 Linkages to Existing Adjacent Developments with no Connection

When proposed development is being planned adjacent to previously developed land and the previously developed land has not incorporated linkage street stubs to its perimeter as part of its recorded plan, the proposed development shall provide access-way connections if at all possible.

If required by DelDOT, the Applicant shall provide right of way for a future access-way connection, and/or a full street connection, within the span of each such property boundary line.

3.5.7.2 Linkages to Existing Adjacent Developments with Connection

When proposed development is being planned adjacent to previously developed land and the previously developed land has incorporated linkage street stubs to its perimeter as part of its recorded plan, the proposed development must incorporate street connections to the existing linkage street right-of-way stubs as part of its street system.

- A. *Sidewalk Interconnections* - All development plans shall provide for sidewalks along future public street connections to adjacent developable parcels along each property boundary that abuts potentially developable or re-developable land in accordance with the provisions for sidewalks.
- B. *Access-ways or Walkways* - Access-ways or walkways for bicycles, pedestrians, and emergency vehicles shall connect the on-site circulation system to existing adjacent bicycle and pedestrian connections, transit facilities and to entrances open to the public that abut the property. Connections may approach parking lots on adjoining properties if the adjoining property used for such connection is open to public pedestrian and bicycle use, is paved, and is unobstructed.

3.5.7.3 Linkages to Undeveloped or Re-developable Property

Where abutting properties are undeveloped or can be expected to be redeveloped within the next ten years, the location and potential arrangement of streets, bicycle and/or pedestrian connections shall be provided at the following spacing to provide for the continuation of these connections into surrounding areas. See Figure 3.5.7.3-a.

- A. *Subdivision Street Type I and II Interconnections* - All development plans shall provide for linkage street stubs at a ratio of one per 1,320 linear feet of the boundary line or fraction thereof, which adjoins potentially developable or re-developable land. The ratio should be rounded to the nearest whole number as shown in Figure 3.5.7.3-a.
- B. *Subdivision Street Type III or Higher Order Road* - All development plans shall provide for future public street connections to adjacent developable parcels by providing a Type III street connection as a continuation of the site circulation and spaced at intervals: 1) in accordance with an approved DelDOT and County local traffic circulation plan; or 2) if no such plan exists, not to exceed 1,320 linear feet along each development plan boundary or as measured from the nearest parallel collector road to the site. Where it is determined that such connections or the spacing thereof are not feasible or practical, DelDOT may at its discretion, waive or modify this requirement.
- C. *Development Adjacent to Vacant Land* - Where new development is adjacent to vacant land likely to be subdivided in the future, all streets, sidewalks bicycle lanes, and access-ways in the development's proposed street system shall continue through to the boundary lines of the area under the same ownership as the subdivision, if directed by DelDOT or the appropriate land use agency to provide for

the orderly subdivision of such adjacent land or the transportation and access needs of the community.

- D. *Redevelopment Projects* - All redevelopment projects shall retrofit existing streets to provide increased vehicular, bicycle and pedestrian connectivity along with increased transit accessibility.
- E. *Sidewalk Interconnections* - All development plans shall provide for sidewalks along future public street connections to adjacent developable parcels along each development plan boundary that abuts potentially developable or re-developable land in accordance with the provisions for sidewalks.
- F. *Walkway and Access-way Interconnections* - All development plans shall provide for future public walkways and/or access-ways, as applicable, to connect to adjacent developable parcels by providing such connections as a continuation of the walkways or access-ways provided for the development in accordance with the walkway and access-way standards for each development plan boundary that abuts potentially developable or re-developable land.
- G. *Stub Street Turn-Around Area* - The right-of-way stubs shall be planned and constructed to the subdivision boundary line for future connections as outlined in Section 5.1.5.2, Temporary Dead End Streets.

Figure 3.5.7.3-a Subdivision Street Interconnections

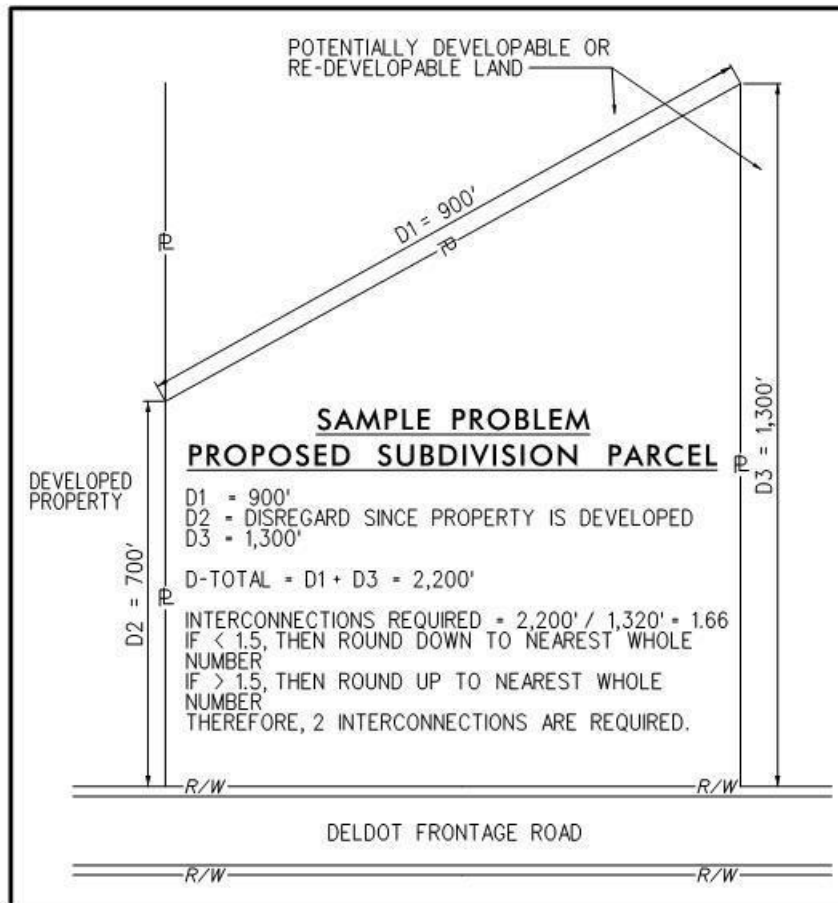

3.5.7.4 Non Residential Cross-Access Interconnectivity

Developments should minimize or eliminate access points along DelDOT frontage roads. Where possible, vehicular access should be shared with the adjacent properties and/or alleys should be used for access. See Figure 3.5.7.4-a.

Figure 3.5.7.4-a Non-Residential Cross-Access Interconnectivity

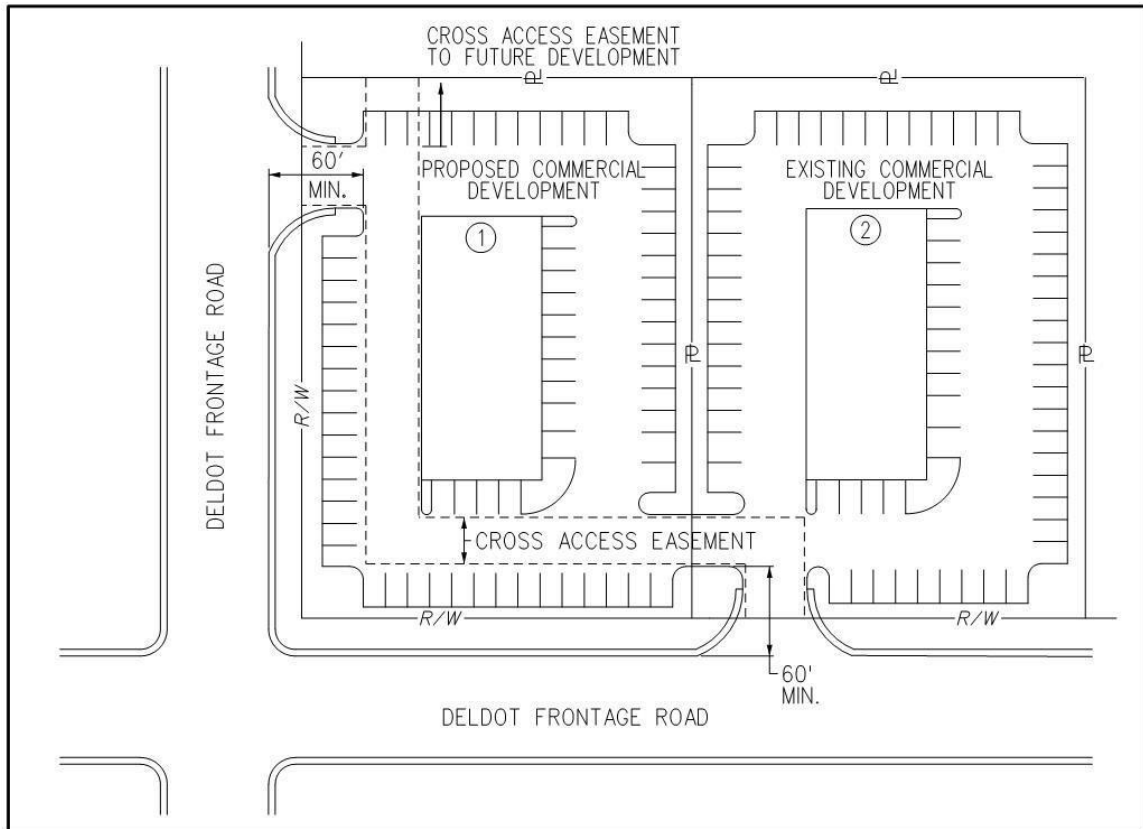

- A. *Cross-Access* - To reduce the number of access points to DelDOT frontage roads, and to promote efficient and convenient access along roadway corridors, shared entrances, connecting driveways and street linkages are recommended wherever practical.
- B. *Aisle length between Cross-access and Street* - A minimum distance of 60 feet shall be required between a cross-access-way and an intersection or driveway entrance to allow for car storage between the cross-access and the driveway.
- C. *Cross-Access Types and Locations* - Locations and types of cross-access will vary from site to site and are dependent upon a number of factors including: overall size of the properties involved, building types and land uses of the properties being served, locations of the existing and proposed buildings, locations of existing and proposed parking lots and site utility and landscape requirements.
- D. *Recordation* - Any cross-access easements shall be shown on the Record Plan for the development and recorded at the applicable local recordation office.

E. Cross-Access Construction:

1. Development plans shall indicate the location of cross-access easement(s).
2. The access connection shall be completed if an immediate or near term benefit (as determined by DelDOT) can be derived by completing the link.
3. If no immediate or near term benefit would be derived, development plans should provide cross access and construction easements and arrange the site design so that when the adjoining property owner extends the connection to the property line, the link will be completed. If the link is to be completed in the future, the grade of the connection, parking, landscaping and other improvements must be set to allow for extension into the adjacent lot.

F. Internal Access Driveways - Whenever possible, internal access drives should be located to join together existing public streets and/ or connect to adjacent private drives so that the internal circulation functions as an integral part of the surrounding transportation network.

3.5.8 Connectivity - Hindrances

Street, bicycle, and/or pedestrian connections are not required where one or more of the following conditions exist:

- A. Where physical or topographic conditions make a street, access-way or walkway connection impracticable. Such conditions include but are not limited to the alignments of existing connecting streets, freeways, railroads, slopes in excess of DelDOT standards, wetlands or other bodies of water where a connection could not reasonably be provided.
- B. Existing buildings or other development on adjacent lands physically preclude a connection now and in the future, considering the potential for redevelopment.
- C. Where the installation of street, bicycle, and/or pedestrian connections would violate provisions of leases, easements, covenants, or restrictions written and put into effect prior to the effective date of these regulations.

DelDOT shall make the final determination as to whether or not a connection shall be made. Where connectivity ratio cannot be met for any of the above reasons, DelDOT may waive the connectivity ratio requirement.

3.6 NOISE MITIGATION

Any major residential development proposed to be constructed in the proximity of any roadway with a functional classification of principal arterial, freeway or interstate will be required to perform a noise analysis and shall meet the requirements of this regulation with regard to the following:

- A. Existing and future noise levels impacting developments proposed along existing transportation facilities
- B. Future noise levels generated by off-site improvements that are linked to proposed land development projects

For residential projects adjacent to existing transportation facilities or requiring off-site improvements to transportation facilities, it is the developer's responsibility to evaluate noise levels and their impacts to proposed and existing development.

3.6.1 Highway Transportation Noise Standards

The Federal Highway Administration (FHWA) has issued regulations for noise evaluation in 23 CFR 772, Procedures for Abatement of Highway Traffic Noise and Construction Noise. DelDOT has developed a noise policy to implement of the requirements of the Federal Highway Administration (FHWA) Noise Standards. Please refer to Delaware Policy Implement No. D-03 for guidance regarding data collection, noise prediction, impact analysis, abatement measures and other procedures used to evaluate highway traffic and construction noise.

3.6.2 Noise Abatement Criteria

The noise abatement criteria, depicted in Table 1, are values which, when approached or exceeded, require the consideration of traffic noise abatement measures. The developer should consider noise mitigation when traffic noise levels exceed one decibel below the values shown in Figure 3.6.3-a.

Figure 3.6.3-a: Noise Abatement Criteria

Activity Category	Design Noise Level Leg (h)	Evaluation Location	Description of Activity Category
A	57 dBA	Exterior	Lands on which serenity and quiet are of extraordinary significance and serve an important public need and where the preservation of those qualities is essential if the area is to continue to serve its intended purpose.
B	67 dBA	Exterior	Residences
C	67 dBA	Exterior	Active sport areas, amphitheaters, auditoriums, campgrounds, cemeteries, day care centers, hospitals, libraries, medical facilities, parks, picnic areas, places of worship, playgrounds, public meeting rooms, public or nonprofit institutional structures, radio studios, recording studios, recreation areas. Section 4(f) sites, schools, television studios, trails and trail crossings.
D	52 dBA	Interior	Auditoriums, day care centers, hospitals, libraries, medical facilities, places of worship, public meeting rooms, public or nonprofit institutional structures, radio studios, recording studios, schools, and television studios.
E	72 dBA	Exterior	Hotels, motels, offices, restaurants/bars, and other undeveloped lands, properties or activities not included in A-D or F.
F	-	-	Agriculture, airports, bus yards, emergency services, industrial, logging, maintenance facilities, manufacturing, mining, rail yards, retail facilities, shipyards, utilities (water resources, water treatment, electrical), and warehousing

3.6.3 Developer Responsibilities: Site Improvements

Development projects fronting roadways that are designated on DelDOT’s Functional Classification Map as a principal arterial, a freeway or an interstate will be required to conduct a noise impact study utilizing the FHWA Traffic Noise Model (TNM) criteria based upon the existing and/or forecasted traffic on the roadway. The noise impact study will predict and evaluate future traffic noise levels for the impacted receptors proposed by the development. In performing the TNM analysis, the developer shall utilize the average pavement type unless an alternative pavement type is approved for use by DelDOT. The developer is required to utilize the TNM to determine at what point during the year would yield the worst traffic noise impacts and utilize those traffic characteristics in performing the noise impact modeling. The study should include examining mitigation measures to shield the future abutting property owners from noise impacts or to reconfigure the site to place less sensitive receptors adjacent to the roadway.

DelDOT will review the noise impact study and analyze proposed mitigation measures as noted in Delaware’s Highway Transportation Noise Policy. In lieu of installing mitigation measures, the Department may suggest that the Developer redesign the site plan by changing impacted areas from sensitive land uses to non-sensitive land uses. The DelDOT letter of no objection to record the development will be contingent upon a layout that has been designed to minimize noise impacts to the satisfaction of DelDOT following the full build-out of the site.

DelDOT will require that the Record Plans for proposed land development projects include provisions for highway noise abatement if the results of the noise analysis indicate an adverse noise impact will result. The security that is required to indemnify the construction agreement for the entrance shall be calculated including the estimated cost to construct the noise mitigation measures specified on the Record Plan.

Although the local land use authority is responsible to ensure that all noise mitigation measures are constructed prior to the issuance of any Certificates of Occupancy for impacted structures, DelDOT will be responsible for insuring that the noise mitigation measures are constructed prior to accepting the street construction. The plans for streets serving impacted residences must include construction plans for noise barriers and/or walls. Noise mitigation measures shall be designed and constructed to meet DelDOT requirements. The security will not be released by the Department until the noise mitigation measure is constructed to DelDOT standards. Maintenance of any fence, berm or noise wall will remain the responsibility of the Developer or community, as described in a maintenance agreement with DelDOT.

3.6.4 Developer Responsibilities: Off-Site Improvements

If a development project requires an off-site improvement which requires the addition of one or more through lanes, the Developer of the land development project will be required to conduct a noise impact study utilizing the FHWA Traffic Noise Model (TNM) criteria based upon the forecast traffic on the improved section of roadway for any road that is designated in whole or in part on the DelDOT Functional Classification Map as a principal arterial, a freeway or an interstate. The noise impact study will predict and evaluate future traffic noise levels for the design that is under consideration. In performing the TNM analysis, the developer shall utilize the average pavement type unless an alternative pavement type is approved for use by DelDOT. The developer is required to utilize the TNM to determine at what point during the year would yield the worst traffic noise impacts and utilize those traffic characteristics in performing the noise impact modeling. The study should include examining mitigation measures to shield current abutting property owners from noise impacts.

DelDOT will review the noise impact study and analyze proposed mitigation measures as noted in Delaware's Highway Transportation Noise Policy. The DelDOT letter of no objection to record will be contingent upon a mitigation plan that has been designed to minimize noise impacts to the satisfaction of DelDOT following the construction of the off-site improvements.

DelDOT will be responsible for insuring that the noise mitigation measures are constructed prior to accepting the street construction. The plans for streets serving impacted residences must include construction plans for noise barriers and/or walls. Any abatement measures are to be constructed by the developer concurrently with the offsite improvements. Noise mitigation measures shall be designed and constructed to meet DelDOT requirements. The security will not be released by the Department until the noise mitigation measure is constructed to DelDOT standards. Maintenance of any fence, berm or noise wall adjacent to an off-site improvement and within DelDOT's Right-of-Way will become the maintenance responsibility of the Department.

3.6.5 Decision Criteria

The criteria below shall be used by DelDOT to ensure that noise mitigation measures are both reasonable and feasible. The feasibility and reasonableness of a potential noise abatement measure must be evaluated before the Department will examine detailed noise mitigation concepts.

3.6.6 Decision Criteria: Feasibility

The evaluation of the feasibility of a noise mitigation measure deals primarily with engineering considerations. The Developer will be required to design all noise mitigation measures with the intention of achieving a noise level below the criteria shown in Figure 3.6.3-a.

However, there are factors that may limit the ability to achieve substantial noise reduction. These factors include but are not limited to the following:

- A. Safety conditions
- B. Access requirements for driveways and entrances
- C. Maintenance requirements
- D. Topography
- E. Drainage
- F. Other noise sources in the area

If the developer is unable to meet the noise levels shown in Figure 3.6.3-a due to the limiting factors listed above (or other limiting factors), DelDOT's Subdivision Engineer may waive the requirement. If the requirement is waived, the record plan should clearly identify the proposed locations that will not meet the noise level requirements shown in Figure 3.6.3-a.

3.6.7 Reasonableness

The Department will evaluate a number of factors when determining if a noise mitigation measure is reasonable. The criteria that shall be used to determine the reasonableness of a noise mitigation measure are listed below:

- A. Noise levels: Noise mitigation will be considered reasonable only for areas where the predicted noise levels for a project approach or exceed the Noise Abatement Criteria.
- B. Cost: A noise mitigation measure will be considered reasonable if the total cost does not exceed \$20,000 per benefited residence. A benefited residence is a dwelling unit that would receive a noise reduction of at least 3 decibels from the installation of a noise barrier.
- C. Environmental Impacts: A noise mitigation measure will be considered reasonable only if the construction of the measure does not have an adverse impact on the natural environment of the area.

3.7 LANDSCAPING

Landscaping is an important aspect of the roadside. Street trees can be added within the right-of-way of a subdivision street under the following conditions:

- A. Additional right of way widths are provided for subdivision streets Types II and III as shown on Figure 3.7-a.
- B. Subdivision streets designed using Integral PCC Curb and Gutter Type 3 shall provide a minimum offset of five feet from the back of the curb and edge of sidewalk/path to the center of the tree trunk.

Approval from DelDOT is required for use of PCC Integral Curb and Gutter Type 3 on Type II subdivision streets.

- C. Subdivision streets designed using Integral PCC Curb and Gutter Type 2 shall provide a minimum offset of eight feet from the back of the curb and a minimum offset of five feet from edge of sidewalk/path to the center of the tree trunk.
- D. A note, (in accordance with DelDOT's current notes which are available online at <http://devcoord.deldot.gov> > Quick Links > DelDOT Notes), is added on the record plan stating that DelDOT will not maintain trees.
- E. A landscaping plan must be submitted for DelDOT review and approval, and the following guidelines must be followed, noted and/or included on the landscape plan:
 - 1. The species of trees to be added within the right-of-way of a subdivision street must be listed in detail and must be confirmed as having been determined to be non-invasive and must not be listed in the Delaware Department of Agriculture's Invasive Species List. Any trees planted are to be installed in accordance with applicable current standards that may be in place at the time of installation, such as: International Society of Arboriculture (ISA) or American National Standards Institute (ANSI).
 - 2. Trees planted within ten feet (10') of a sidewalk or other pedestrian facility must be grown with a structured canopy limbed to a seven foot (7') minimum clearance at time of installation. Annual street tree maintenance must include structural pruning of the canopy until a maximum height clearance of ten feet (10') has been acquired and maintained.
 - 3. A Certified Tree Inventory and a Maintenance Plan for any trees planted in the right of way must be submitted to the Homeowners Association prior to acceptance of the subdivision by the Department.
 - 4. The Certified Tree Inventory should be completed by an ISA-certified arborist, and must identify the community's public trees (trees in open spaces, along streets, entranceways, greenways, parks, etc.).
 - 5. The Tree Management Plan should be developed by an ISA-certified arborist and must detail tree maintenance scheduling and timing; tree replacement schedule; pruning and tree maintenance practices using best management practices and ANSI standards.
 - 6. The Maintenance Organization or Home Owners' Association are responsible for maintenance of any trees planted in the state right of way within a subdivision, to include pruning, pest control and any necessary hazard remediation to include complete removal as required for safety of the adjoining properties and users of the subdivision streets.
 - 7. Trees planted in containers must receive consistent and frequent attention to maintain a healthy vigor. Feeding, watering and winterization are of particular importance.
- F. Placement of landscaping shall not impact sight distance or sidewalk stability.

Figure 3.7-a
Street Trees

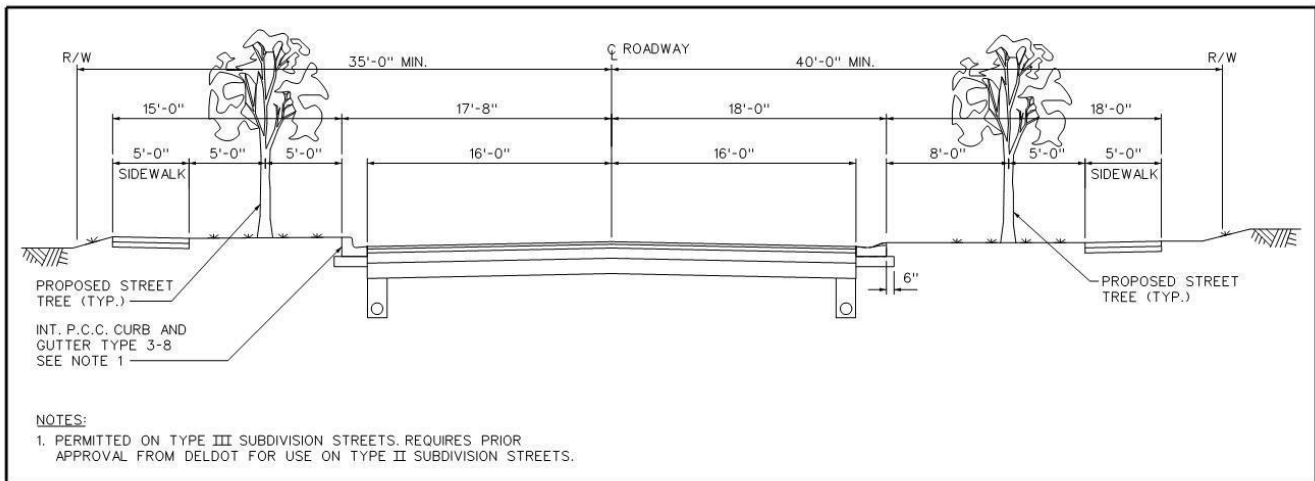

3.7.1 Landscaping - Median Islands

Median islands within a subdivision may also be landscaped, provided the following criteria are met:

- If street trees are proposed, the islands must have PCC Curb, Type 1-8. There is a minimum offset of five feet from the back of the curb to the center of the trunk of the tree.
- If no street trees are being proposed, PCC Curb, Type 2 may be used.
- A note, (in accordance with DelDOT's current notes which are available online at <http://devcoord.deldot.gov> > Quick Links > DelDOT Notes), is added to the record plan stating that DelDOT will not maintain landscaping or trees.
- Placement of landscaping shall not impact sight distance.
- Maintenance Agreement will be established for the landscaping in the median.

3.7.2 Landscaping - Reforestation Regulations and Ordinances

The requirements established by these regulations, including but not limited to the right-of-way dedication/reservation, permanent easements, shared use paths, auxiliary lanes at the entrance, sight triangles, and drainage features, shall be incorporated into the Record Plan prior to any evaluation of tree impacts as required by the local land use agency and other guidelines such as those found in Appendix A of DelDOT's *Road Design Manual*.

3.8 STORMWATER AND DRAINAGE REQUIREMENTS FOR RECORD PLAN

Private stormwater management facilities shall be located a minimum of 20 feet from the State right-of-way, as measured to the top of slope of the facility.

Construction Plans shall be sufficiently developed at the Record Plan stage to allow for adequate review of any drainage easement needs. Drainage easements are generally required for any conveyance systems that carry roadway drainage, see Sections 3.2.5.1.4 and 5.7.2.6 of this manual.

See Chapter 5 for further guidance related to design of drainage facilities.

3.9 TRAFFIC CALMING

Traffic calming shall be considered in the site plan development. The applicant's engineer shall identify areas where higher traffic speeds and volumes are expected and shall include appropriate traffic calming design elements.

DelDOT's Traffic Calming Design Manual (TCDM) provides detailed guidance regarding the appropriate use, design, signing and marking of traffic calming measures that have been evaluated by DelDOT and are preferred for use.