

DRAINAGE INLET FRAME AND GRATES

SCALE : N.T.S.

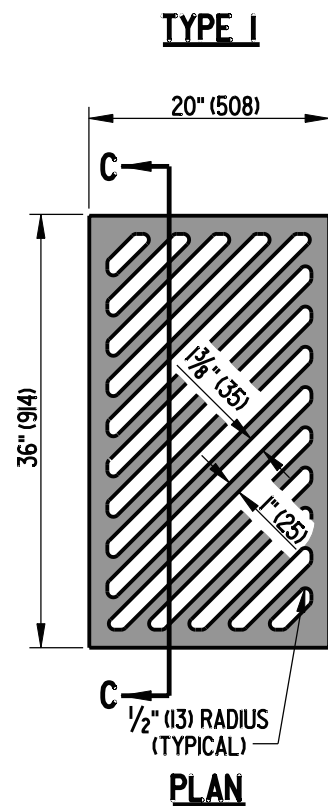

PLAN

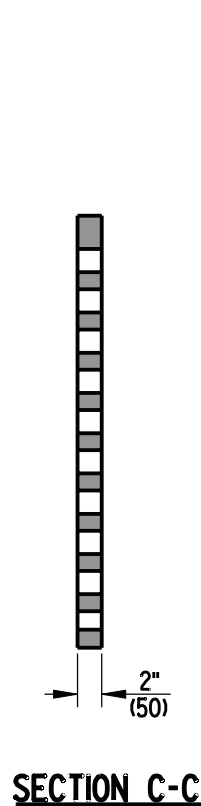

SECTION C-C

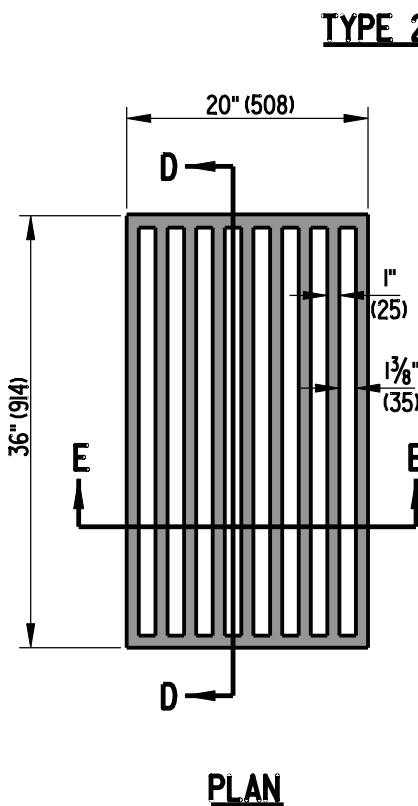

PLAN

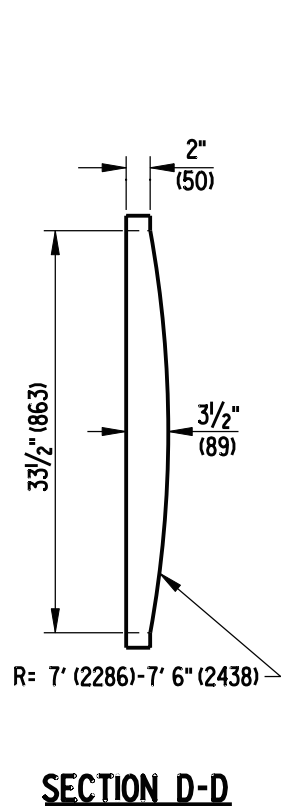

SECTION D-D

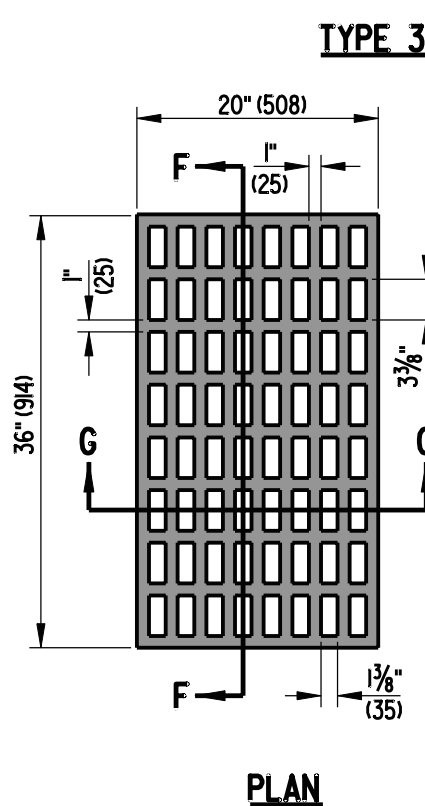

PLAN

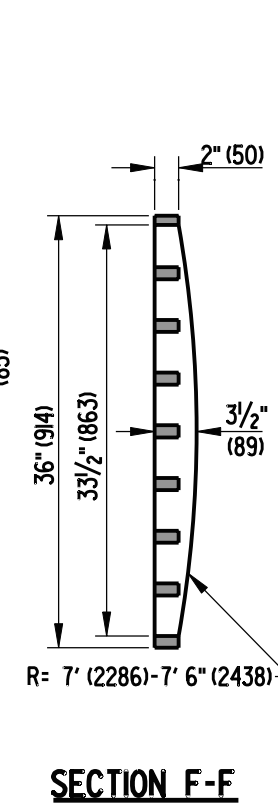

SECTION F-F

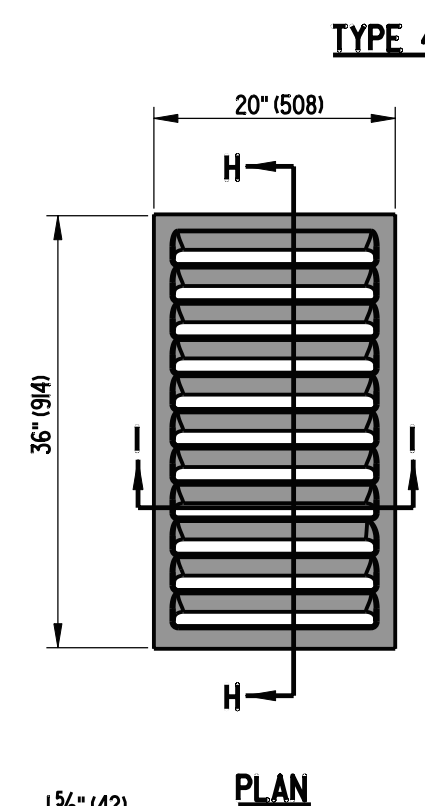

PLAN

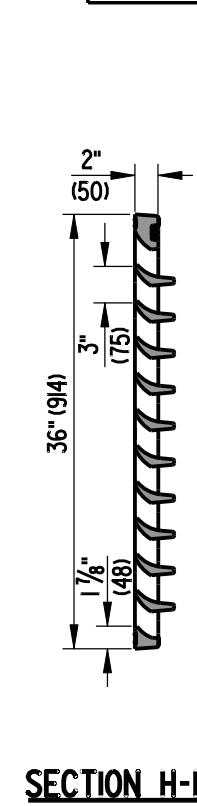

SECTION H-H

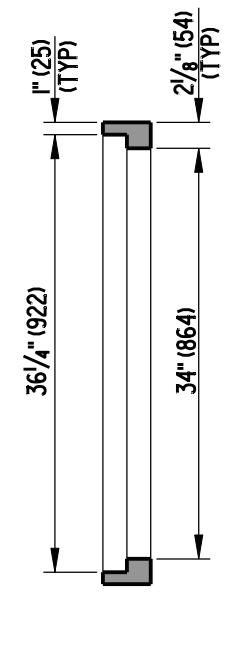

SECTION B-B

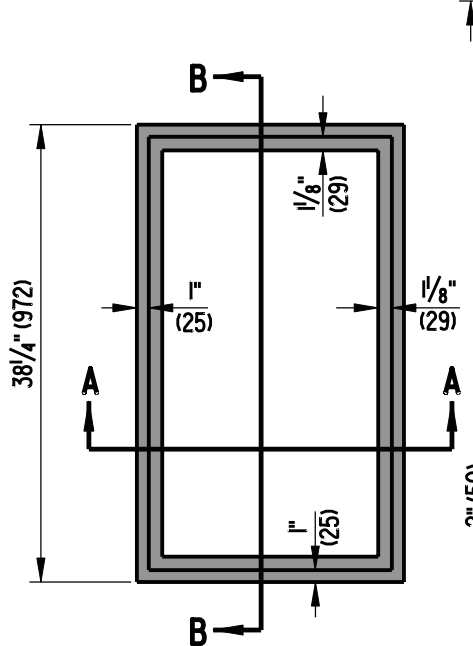

DRAINAGE INLET FRAME

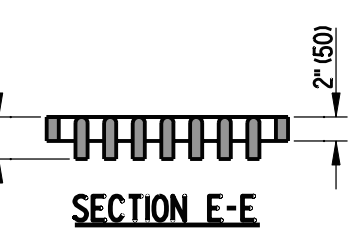

SECTION E-E

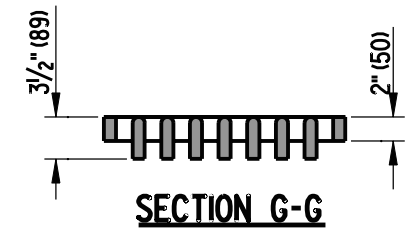

SECTION G-G

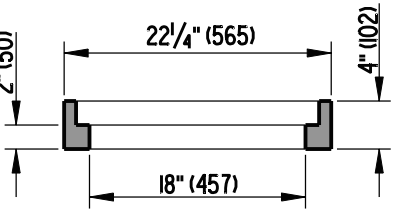

SECTION A-A

NOTES:

- 1). THE TYPE 2 DRAINAGE INLET GRATE SHALL NOT BE INSTALLED WHERE BICYCLE TRAFFIC MAY BE PRESENT.
- 2). THE TOP OF ALL DRAINAGE INLET GRATES SHALL BE LABELED "ONLY RAIN DOWN THE STORM DRAIN". ALSO, DRAINAGE INLET GRATES TYPE 1 AND TYPE 4 SHALL BE LABELED WITH "WATER FLOW" AND AN ARROW INDICATING FLOW DIRECTION AS SHOWN IN THE EXAMPLE DETAIL.
- 3). THE TYPE 1 DRAINAGE INLET GRATE SHALL BE LABELED WITH "CURBSIDE" AS SHOWN ON THE EXAMPLE DETAIL. ALL LABELING ON THE TYPE 1 SHALL BE ON BOTH TOP AND BOTTOM SIDES DUE TO THE TYPE 1 BEING REVERSIBLE.

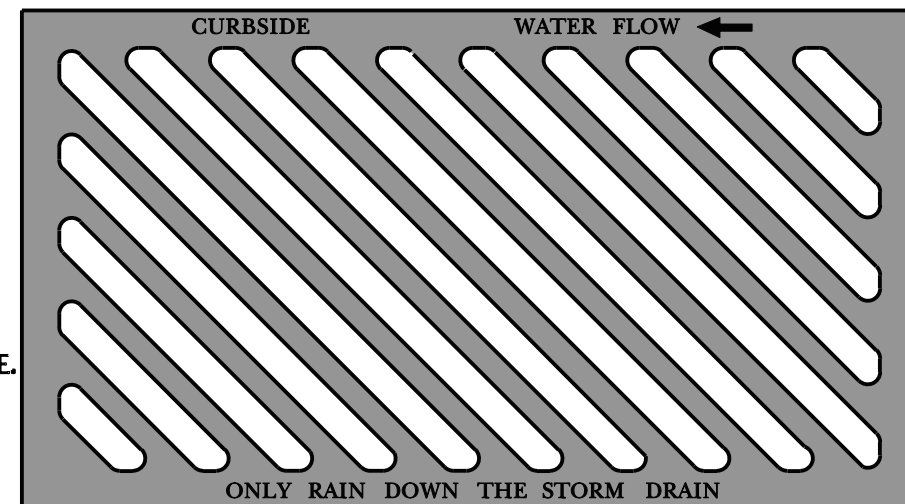

DRAINAGE GRATE LABELING EXAMPLE DETAIL



**DELAWARE
DEPARTMENT OF TRANSPORTATION**

DRAINAGE INLET DETAILS

STANDARD NO. **D-5 (2007)**

SHT. **2** OF **9**

APPROVED

[Signature]
CHIEF ENGINEER

10/24/07
DATE

RECOMMENDED

[Signature]
DESIGN ENGINEER

10/23/07
DATE