

**BEGIN
CONTRACT T201011308
STATION 667+50**

DRAFT

NOT FOR BIDDING

AUGUST 2015

FUTURE BOYD'S CORNER ROAD
CONSTRUCTION

SB EMERGENCY ACCESS RAMP
CONSTRUCTION

US 301 CONSTRUCTION

MATCHLINE STA. 690+00

LEGEND	
---	CROSS SECTION MATCHLINE
.....	BMP SURFACE
-----	BORROW SITE

NOTE:
ALL CROSS SECTIONS ARE TAKEN RADIAL TO A BASELINE
AND AT 50' INTERVALS UNLESS OTHERWISE NOTED.

ADDENDUMS / REVISIONS

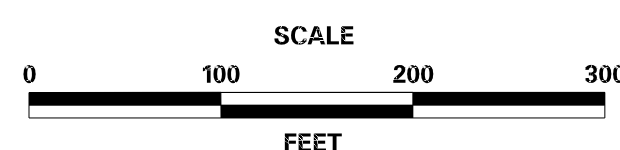

**US 301,
SR 896 TO SR 1**

CONTRACT T200911308	BRIDGE NO.
COUNTY NEW CASTLE	DESIGNED BY:
	CHECKED BY:

**METHOD OF
CROSS SECTIONS**

XS-01
SHEET NO. 2
TOTAL SHTS. 337

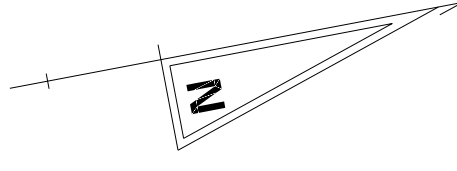

DRAFT
NOT FOR BIDDING
AUGUST 2015

MATCHLINE STA. 690+00

MATCHLINE STA. 713+00

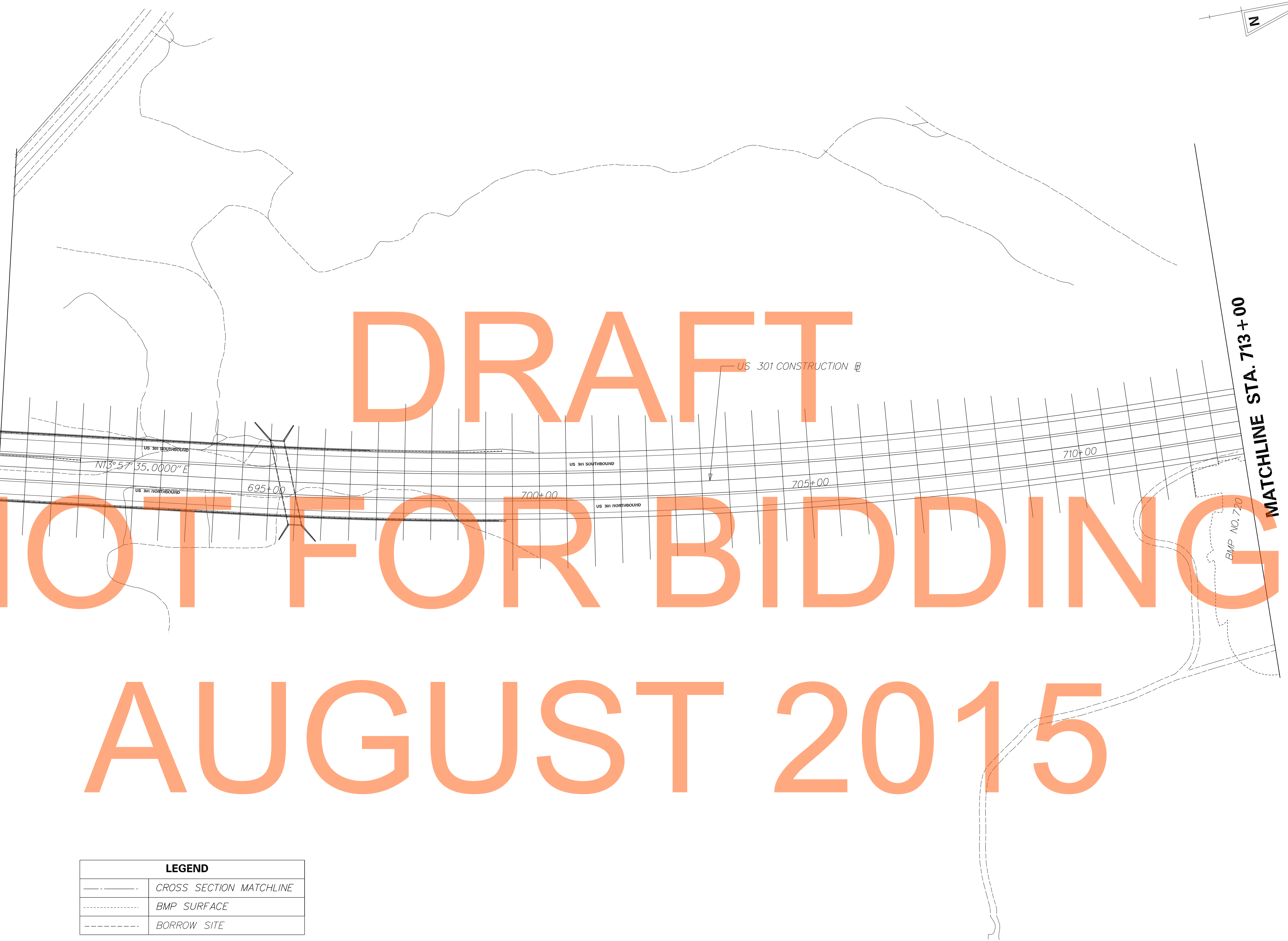

LEGEND	
---	CROSS SECTION MATCHLINE
.....	BMP SURFACE
-----	BORROW SITE

NOTE:
ALL CROSS SECTIONS ARE TAKEN RADIAL TO A BASELINE
AND AT 50' INTERVALS UNLESS OTHERWISE NOTED.

SECTION 805
ADDRESS
REVISED



ADDENDUMS / REVISIONS	

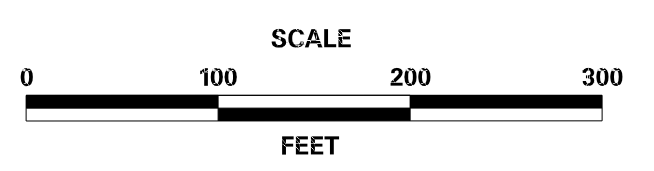

US 301,
SR 896 TO SR 1

CONTRACT T200911308	BRIDGE NO.
COUNTY NEW CASTLE	DESIGNED BY:
	CHECKED BY:

METHOD OF
CROSS SECTIONS

XS-02
SHEET NO. 3
TOTAL SHTS. 337

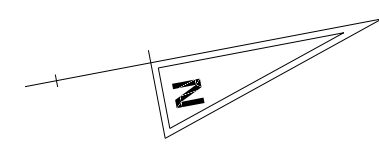

DRAFT
NOT FOR BIDDING
AUGUST 2015

LEGEND	
	CROSS SECTION MATCHLINE
	BMP SURFACE
	BORROW SITE

NOTE:
ALL CROSS SECTIONS ARE TAKEN RADIAL TO A BASELINE
AND AT 50' INTERVALS UNLESS OTHERWISE NOTED.

ADDENDUMS / REVISIONS

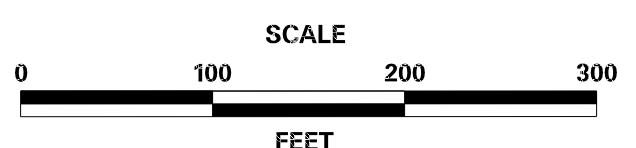

**US 301,
SR 896 TO SR 1**

CONTRACT T200911308	BRIDGE NO.
COUNTY NEW CASTLE	DESIGNED BY:
	CHECKED BY:

**METHOD OF
CROSS SECTIONS**

XS-03
SHEET NO. 4
TOTAL SHTS. 337

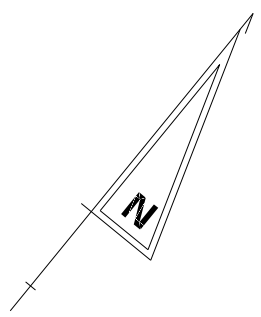

DRAFT
NOT FOR BIDDING
AUGUST 2015



LEGEND	
- - - - -	CROSS SECTION MATCHLINE
.....	BMP SURFACE
- - - - -	BORROW SITE

NOTE:
ALL CROSS SECTIONS ARE TAKEN RADIAL TO A BASELINE
AND AT 50' INTERVALS UNLESS OTHERWISE NOTED.

S:\DRAWINGS\ADDRESS - RTIMES



ADDENDUMS / REVISIONS

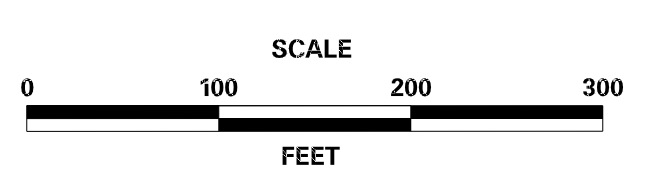

US 301,
SR 896 TO SR 1

CONTRACT T200911308	BRIDGE NO.
COUNTY NEW CASTLE	DESIGNED BY:
	CHECKED BY:

METHOD OF CROSS SECTIONS

XS-04
SHEET NO. 5
TOTAL SHTS. 337

LIMIT OF CONSTRUCTION
 CONTRACT T201011308
 STATION 132+93

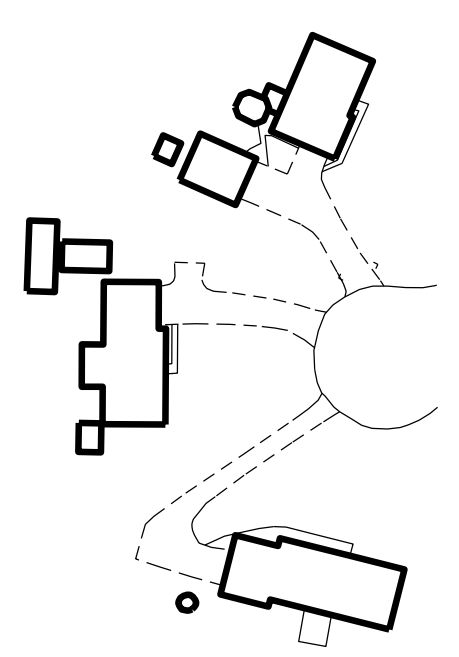
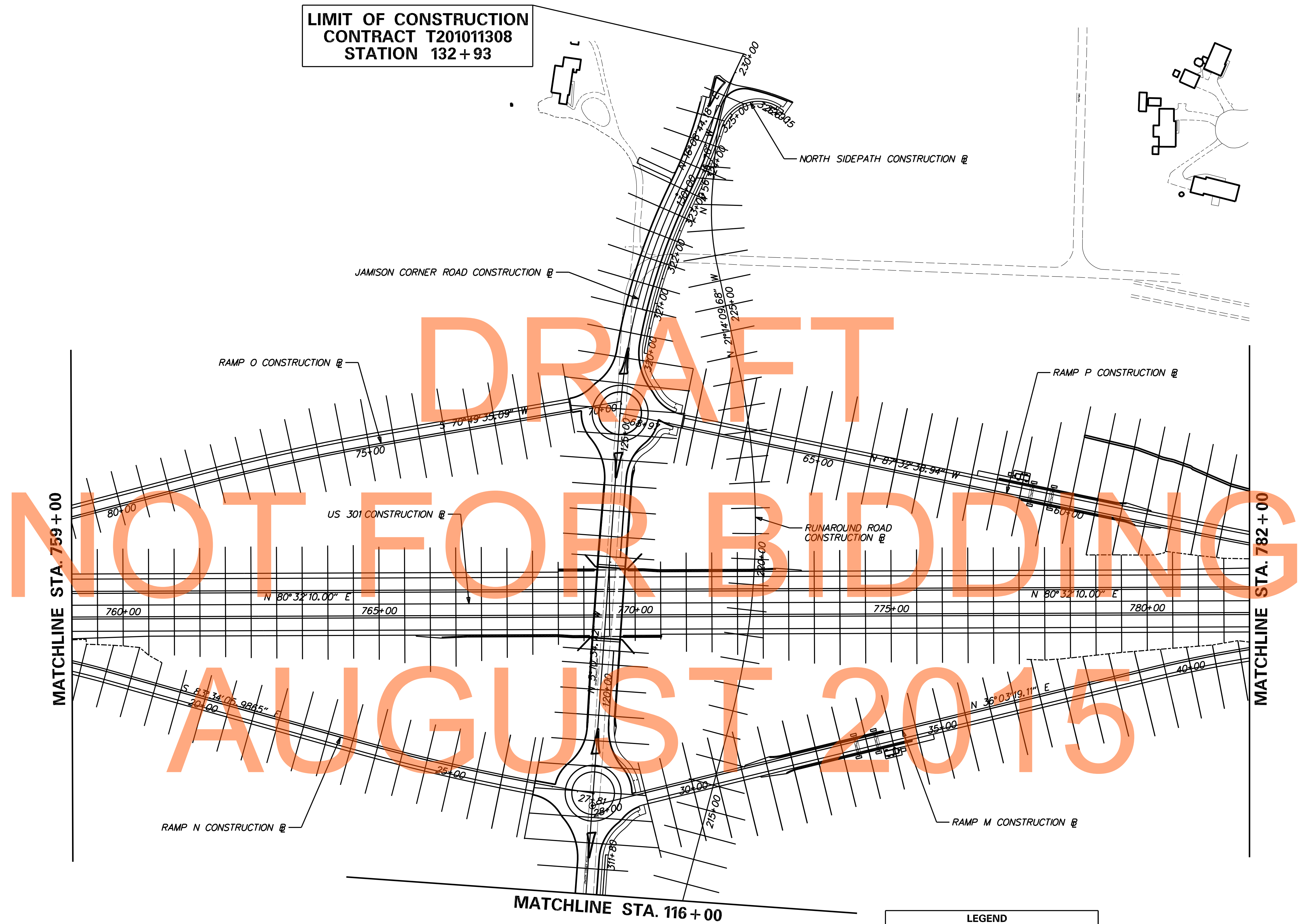

DRAFT
 NOT FOR BIDDING
 AUGUST 2015

LEGEND	
-----	CROSS SECTION MATCHLINE
-----	BMP SURFACE
-----	BORROW SITE

NOTE:
 ALL CROSS SECTIONS ARE TAKEN RADIAL TO A BASELINE
 AND AT 50' INTERVALS UNLESS OTHERWISE NOTED.

ADDENDUMS / REVISIONS

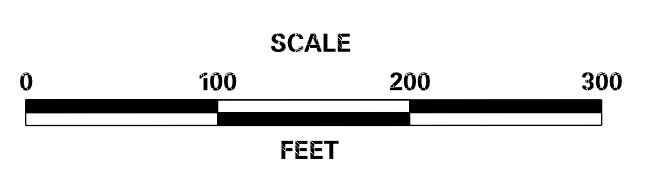

US 301,
 SR 896 TO SR 1

CONTRACT T200911308	BRIDGE NO.
COUNTY NEW CASTLE	DESIGNED BY:
	CHECKED BY:

METHOD OF
 CROSS SECTIONS

XS-05
SHEET NO. 6
TOTAL SHTS. 337

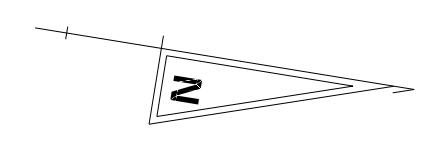

LIMIT OF CONSTRUCTION
CONTRACT T201011308
STATION 103 + 50

DRAFT

NOT FOR BIDDING

AUGUST 2015



LEGEND	
---	CROSS SECTION MATCHLINE
.....	BMP SURFACE
-----	BORROW SITE

NOTE:
ALL CROSS SECTIONS ARE TAKEN RADIAL TO A BASELINE
AND AT 50' INTERVALS UNLESS OTHERWISE NOTED.

SECTION 805
ADDRESS
REVISED



ADDENDUMS / REVISIONS	

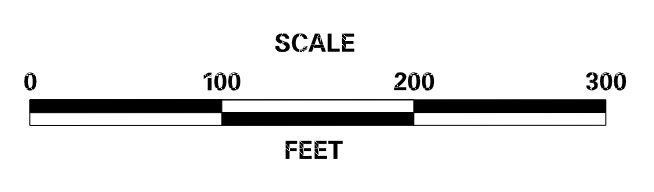

US 301,
SR 896 TO SR 1

CONTRACT T200911308	BRIDGE NO.
COUNTY NEW CASTLE	DESIGNED BY:
	CHECKED BY:

METHOD OF CROSS SECTIONS	SHEET NO. 7
	TOTAL SHTS. 337

XS-06



**LIMIT OF CONSTRUCTION
CONTRACT T201011308
STATION 902+81**

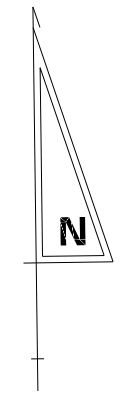

DRAFT
NOT FOR BIDDING
AUGUST 2015

LEGEND	
—+—+—+—	CROSS SECTION MATCHLINE
-----	BMP SURFACE
-----	BORROW SITE

NOTE:
ALL CROSS SECTIONS ARE TAKEN RADIAL TO A BASELINE
AND AT 50' INTERVALS UNLESS OTHERWISE NOTED.

S:\DRAWINGS\ADDRESS - RTIMES



ADDENDUMS / REVISIONS	

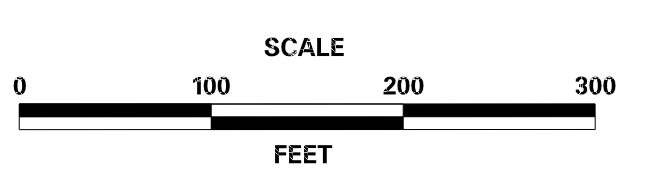

**US 301,
SR 896 TO SR 1**

CONTRACT T200911308	BRIDGE NO.
COUNTY NEW CASTLE	DESIGNED BY:
	CHECKED BY:

**METHOD OF
CROSS SECTIONS**

XS-07
SHEET NO. 8
TOTAL SHTS. 337

DRAFT

NOT FOR BIDDING

AUGUST 2015

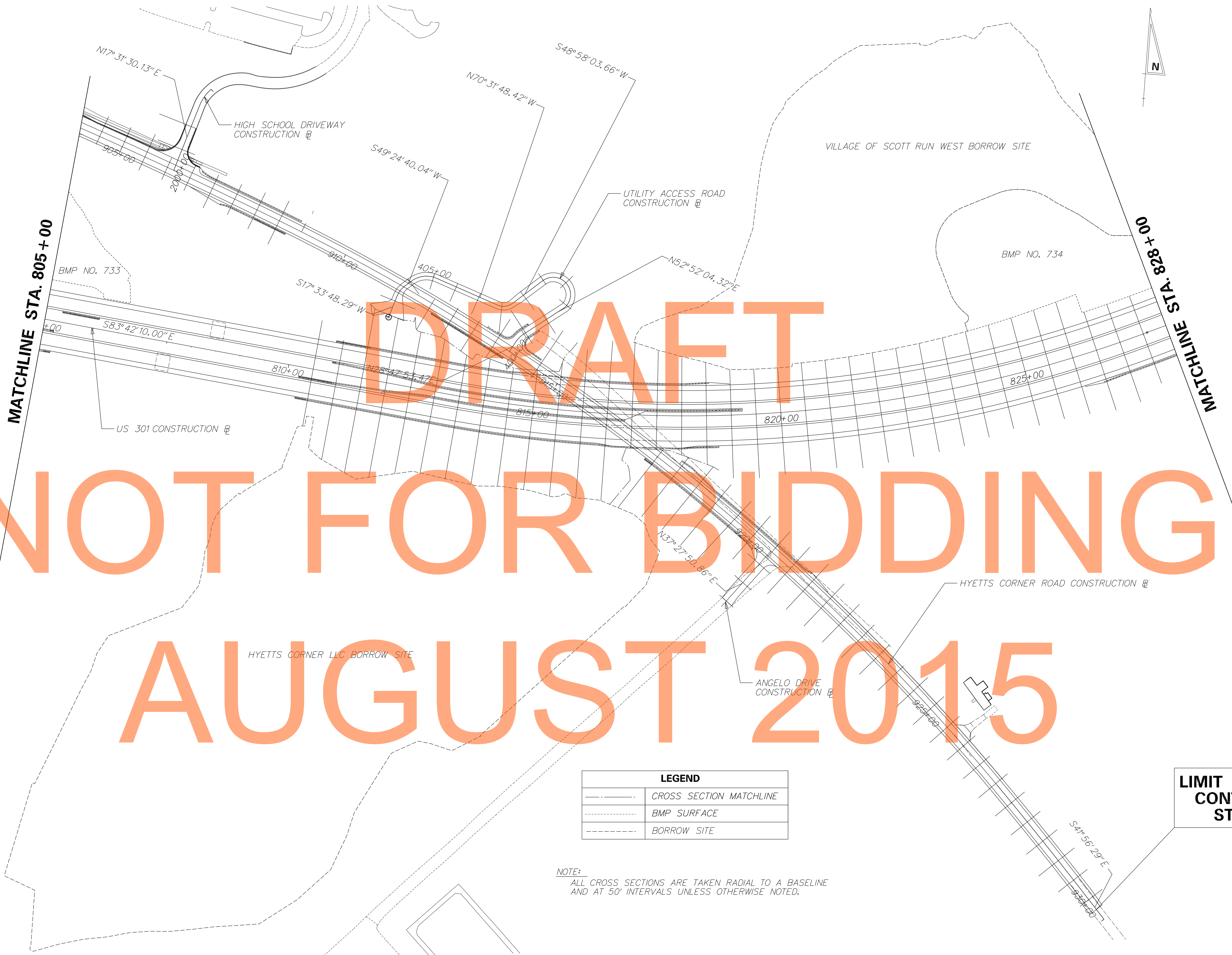

LEGEND	
---	CROSS SECTION MATCHLINE
---	BMP SURFACE
---	BORROW SITE

NOTE:
ALL CROSS SECTIONS ARE TAKEN RADIAL TO A BASELINE
AND AT 50' INTERVALS UNLESS OTHERWISE NOTED.

**LIMIT OF CONSTRUCTION
CONTRACT T201011308
STATION 930+25**

ADDENDUMS / REVISIONS

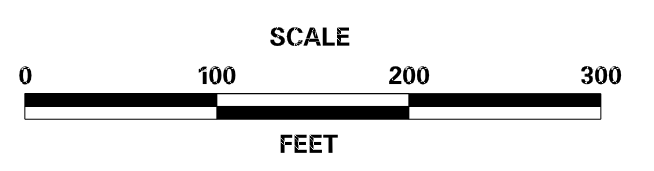

**US 301,
SR 896 TO SR 1**

CONTRACT T200911308	BRIDGE NO.
COUNTY NEW CASTLE	DESIGNED BY:
	CHECKED BY:

**METHOD OF
CROSS SECTIONS**

XS-08
SHEET NO. 9
TOTAL SHTS. 337

DRAFT

VILLAGE OF SCOTT RUN EAST BORROW SITE

NOT FOR BIDDING

AUGUST 2015

MATCHLINE STA. 828 + 00

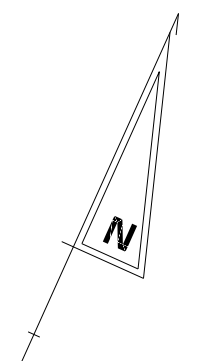

END
CONTRACT T201011308
STATION 848 + 00

LEGEND	
— — — — —	CROSS SECTION MATCHLINE
.....	BMP SURFACE
-----	BORROW SITE

NOTE:
 ALL CROSS SECTIONS ARE TAKEN RADIAL TO A BASELINE
 AND AT 50' INTERVALS UNLESS OTHERWISE NOTED.

S:\DRAWINGS\ADDRESS - RTIMES



ADDENDUMS / REVISIONS	

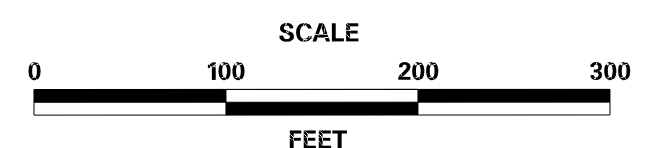

US 301,
SR 896 TO SR 1

CONTRACT T200911308	BRIDGE NO.
COUNTY NEW CASTLE	DESIGNED BY:
	CHECKED BY:

METHOD OF
CROSS SECTIONS

XS-09
SHEET NO. 10
TOTAL SHTS. 337

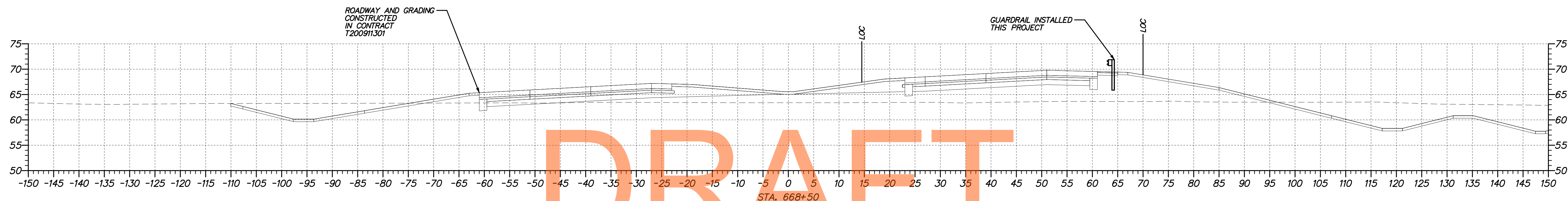

DRAFT

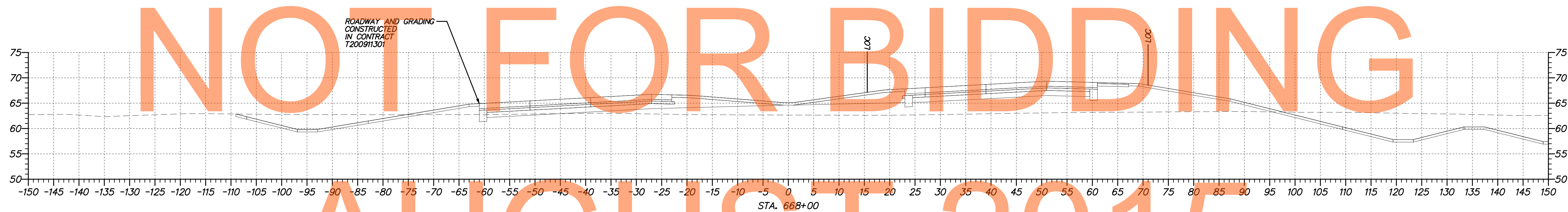

NOT FOR BIDDING

AUGUST 2015

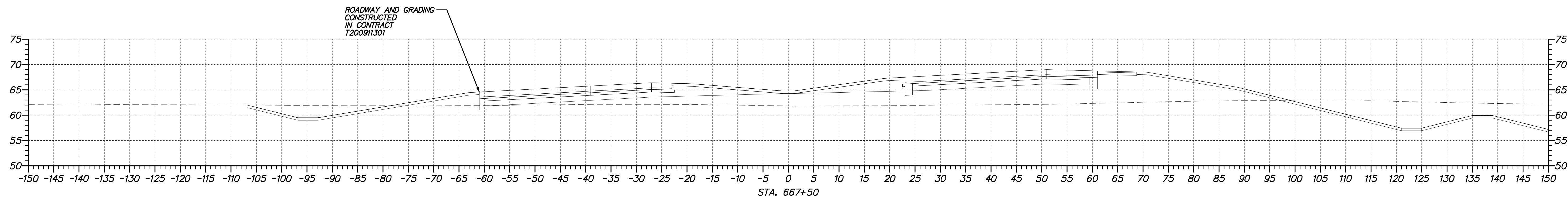

ADDENDUMS / REVISIONS	

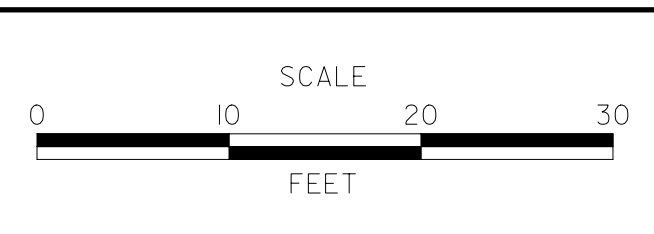

**US 301,
SR 896 TO SR 1**

CONTRACT T200911308	BRIDGE NO.
COUNTY NEW CASTLE	DESIGNED BY: WJD
	CHECKED BY: MAA

**CROSS SECTIONS
US 301 MAINLINE
STA. 667+50 TO STA. 668+50**

SHEET NO. 11
TOTAL SHTS. 337

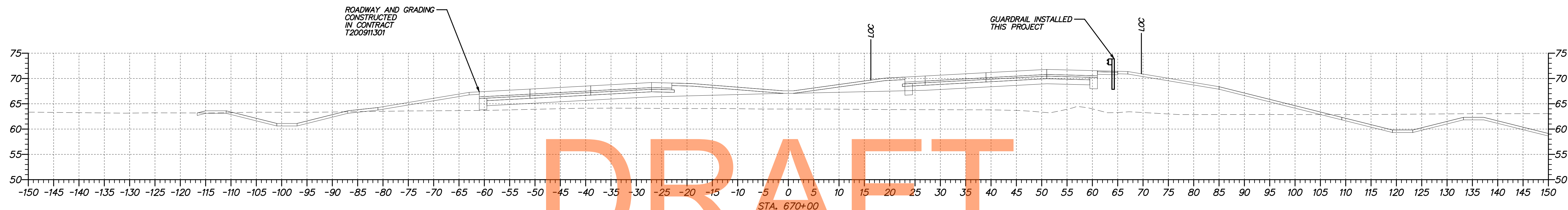

DRAFT

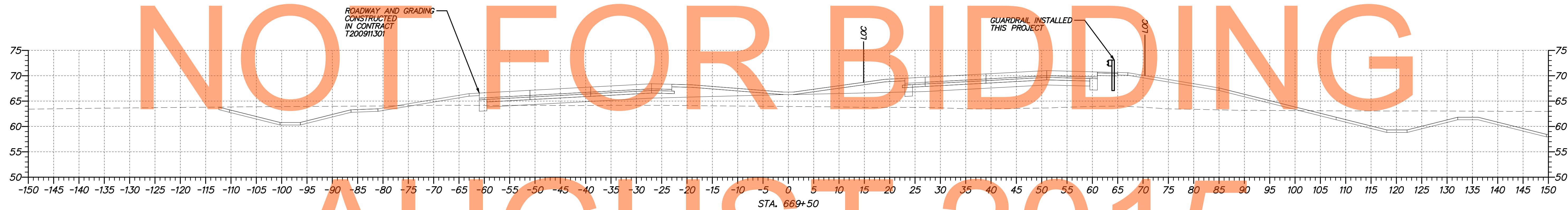

AUGUST 2015

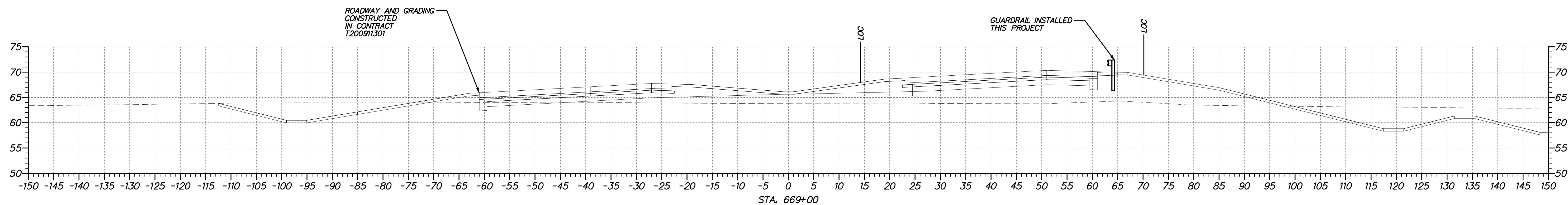

ADDENDUMS / REVISIONS	

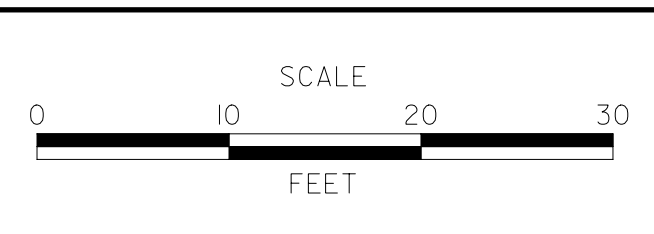

US 301,
SR 896 TO SR 1

CONTRACT T200911308	BRIDGE NO.
COUNTY NEW CASTLE	DESIGNED BY: WJD
	CHECKED BY: MAA

**CROSS SECTIONS
US 301 MAINLINE**
STA. 669+00 TO STA. 670+00

SHEET NO. 12
TOTAL SHTS. 337

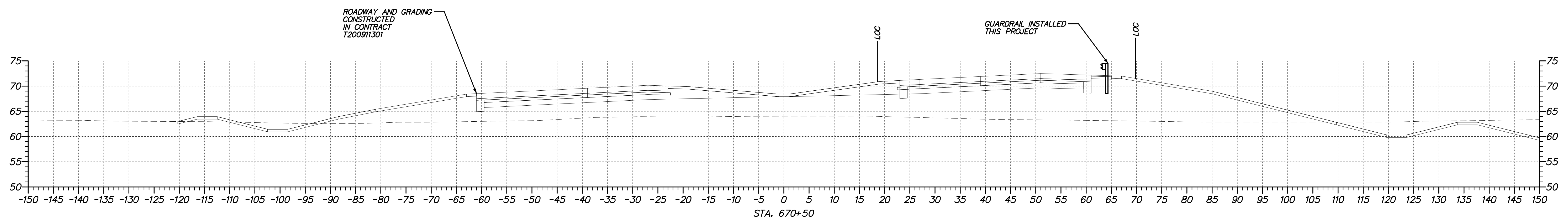
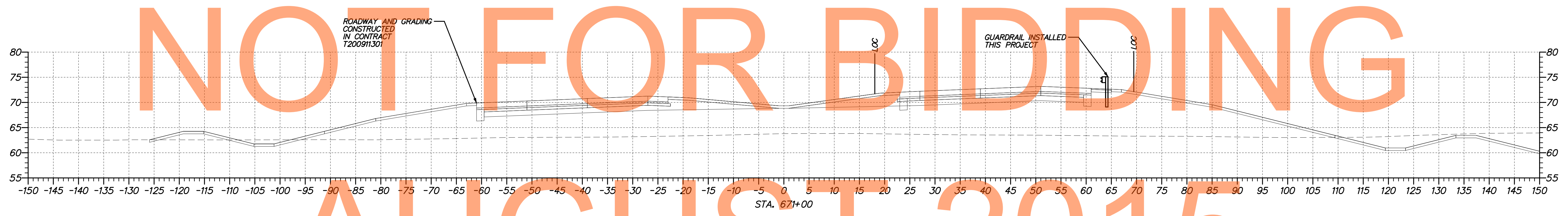
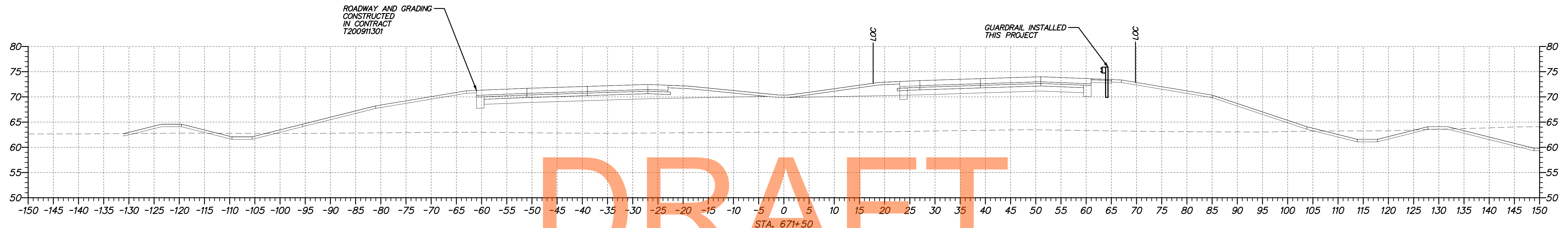

DRAFT

NOT FOR BIDDING

AUGUST 2015

ADDENDUMS / REVISIONS	

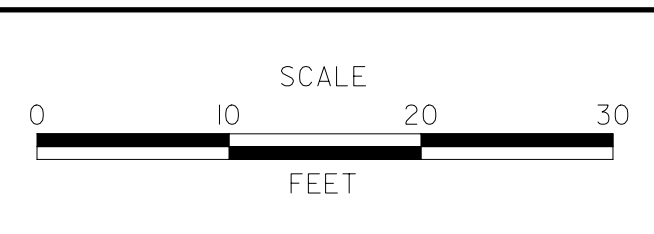

**US 301,
SR 896 TO SR 1**

CONTRACT T200911308	BRIDGE NO.
COUNTY NEW CASTLE	DESIGNED BY: WJD
	CHECKED BY: MAA

**CROSS SECTIONS
US 301 MAINLINE
STA. 670+50 TO STA. 671+50**

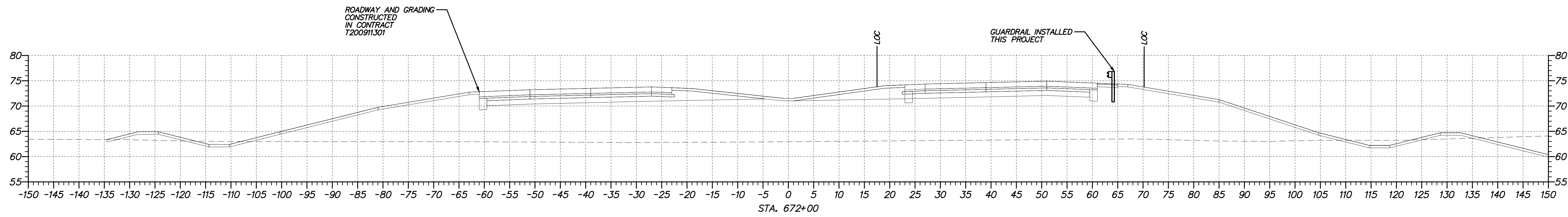
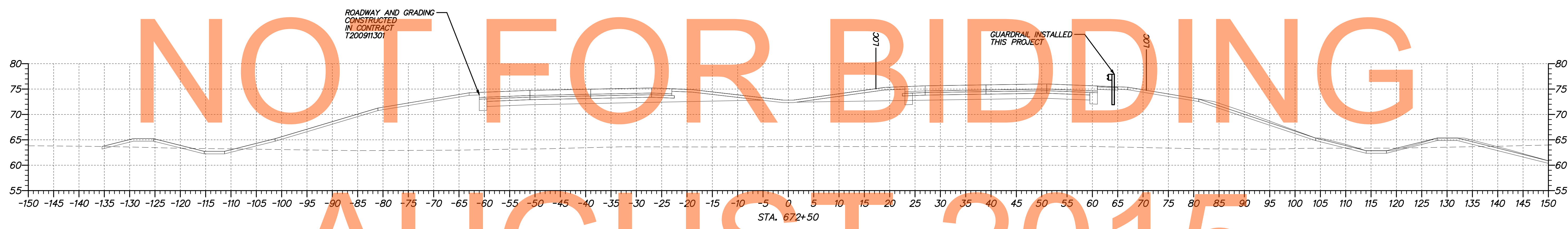
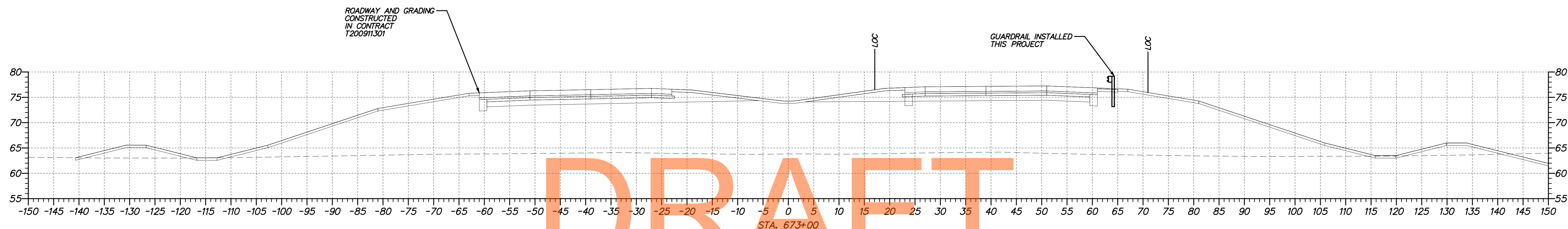

DRAFT

NOT FOR BIDDING

AUGUST 2015



ADDENDUMS / REVISIONS	

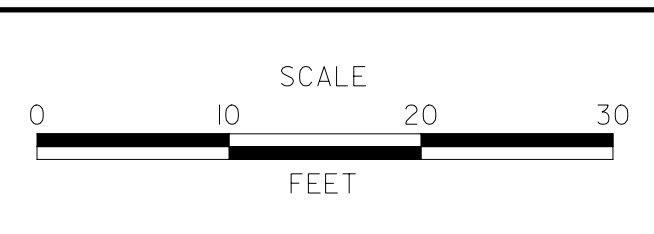

**US 301,
SR 896 TO SR 1**

CONTRACT T200911308	BRIDGE NO.
COUNTY NEW CASTLE	DESIGNED BY: WJD CHECKED BY: MAA

**CROSS SECTIONS
US 301 MAINLINE
STA. 672+00 TO STA. 673+00**

SHEET NO. 14
TOTAL SHTS. 337

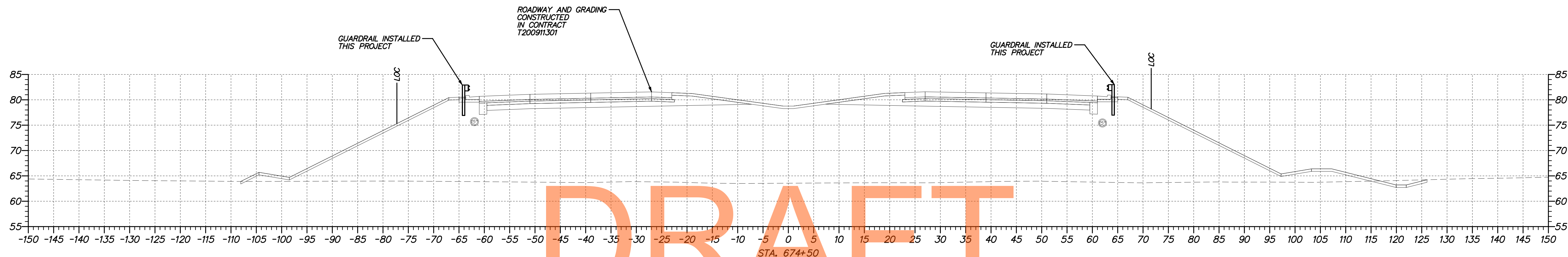

DRAFT

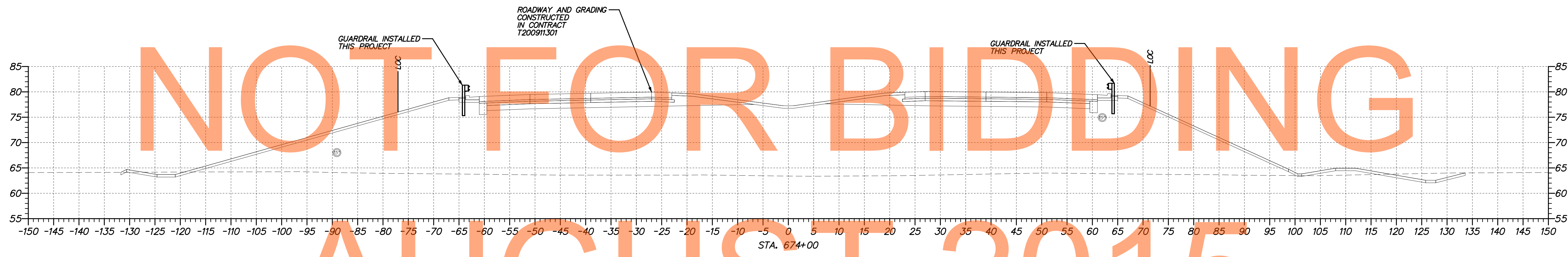

AUGUST 2015

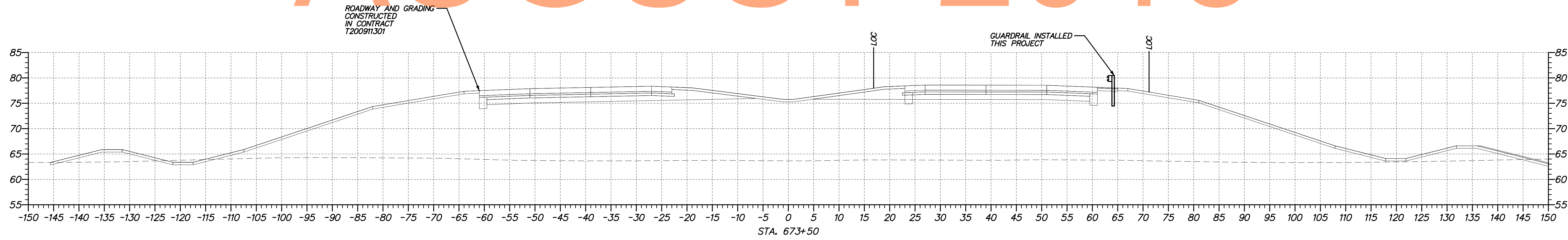

ADDENDUMS / REVISIONS	

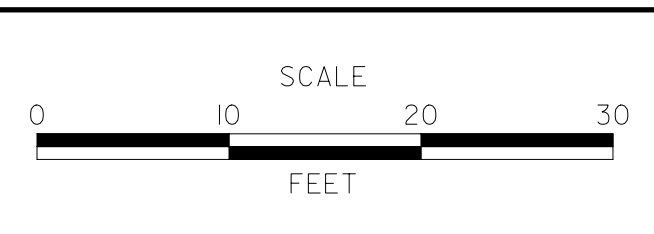

US 301,
SR 896 TO SR 1

CONTRACT T200911308	BRIDGE NO.
COUNTY NEW CASTLE	DESIGNED BY: WJD
	CHECKED BY: MAA

CROSS SECTIONS
US 301 MAINLINE
STA. 673+50 TO STA. 674+50

SHEET NO. 15
TOTAL SHTS. 337

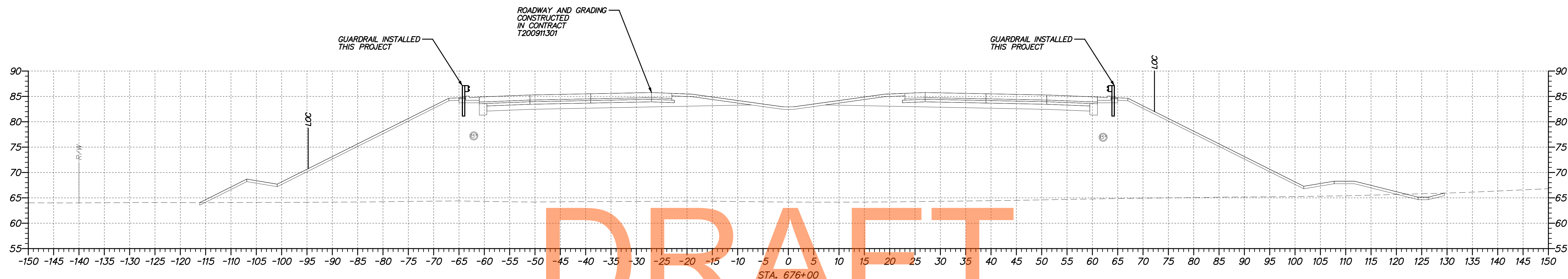

DRAFT

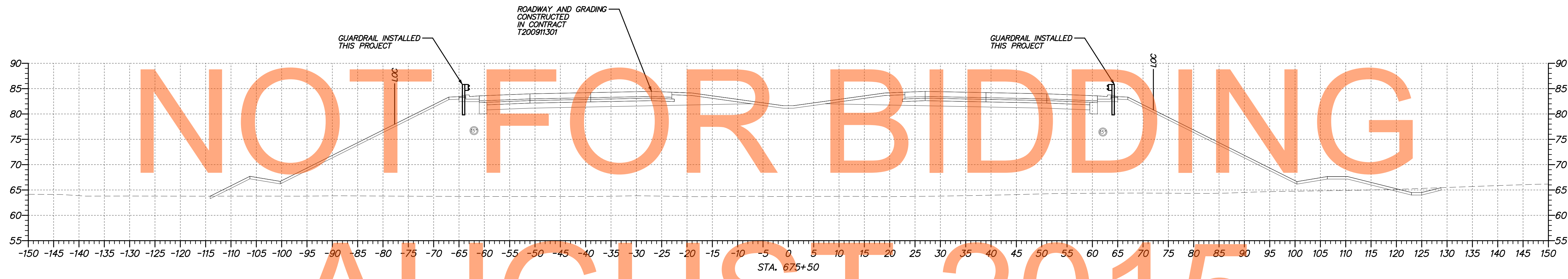

AUGUST 2015

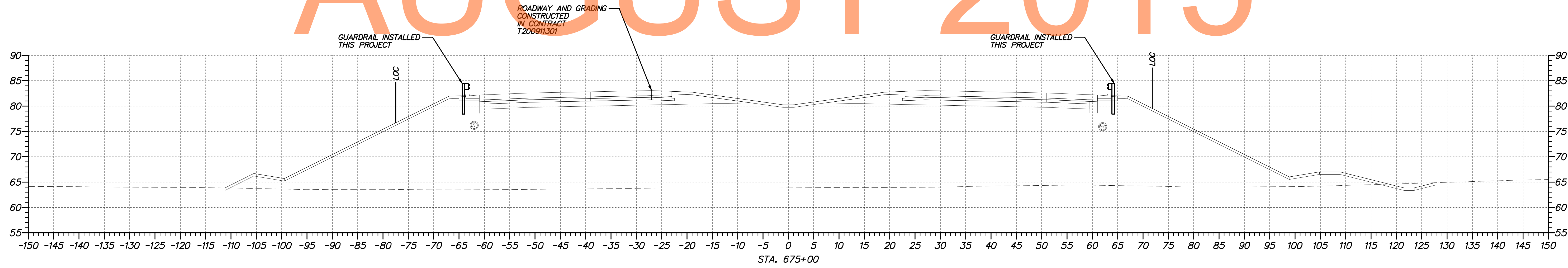

ADDENDUMS / REVISIONS	

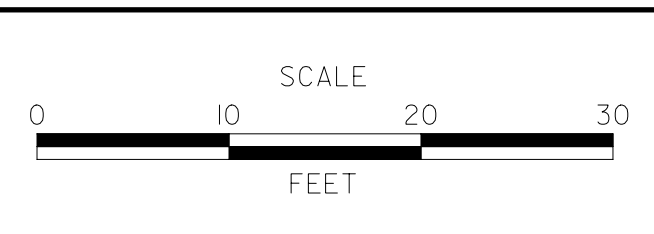

US 301,
SR 896 TO SR 1

CONTRACT T200911308	BRIDGE NO.
COUNTY NEW CASTLE	DESIGNED BY: WJD
	CHECKED BY: MAA

**CROSS SECTIONS
US 301 MAINLINE**
STA. 675+00 TO STA. 676+00

SHEET NO. 16
TOTAL SHTS. 337

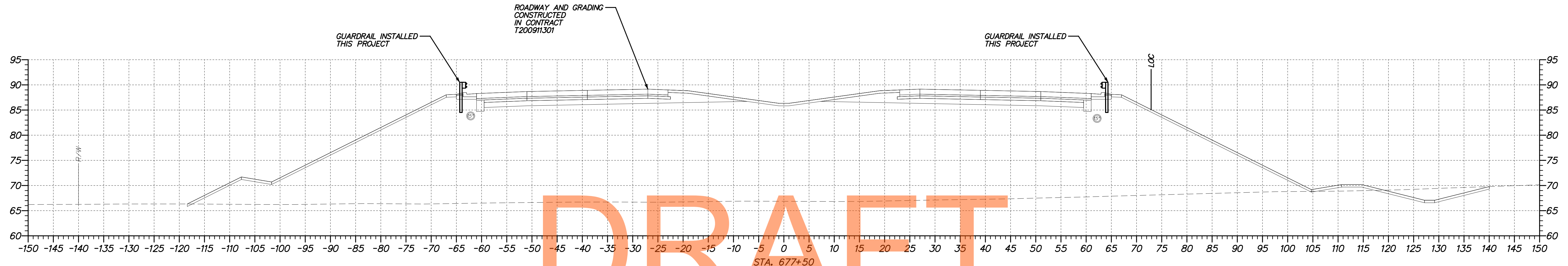

DRAFT

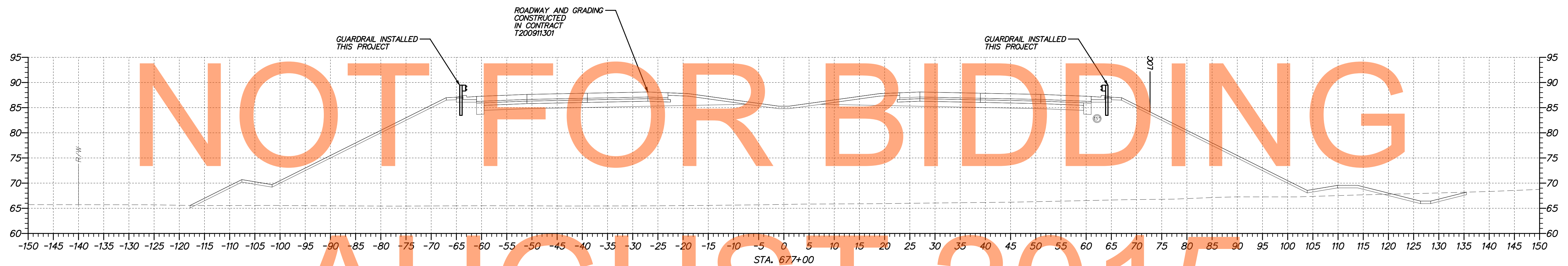

NOT FOR BIDDING

AUGUST 2015

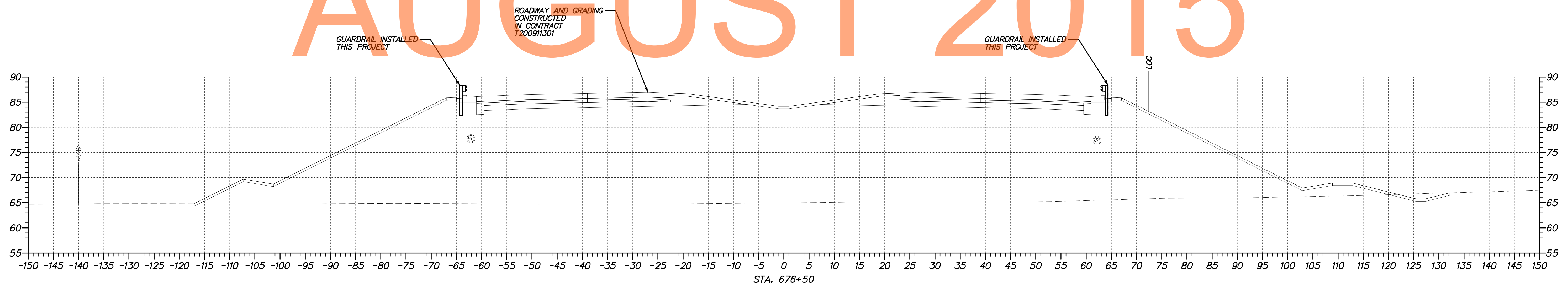

ADDENDUMS / REVISIONS	

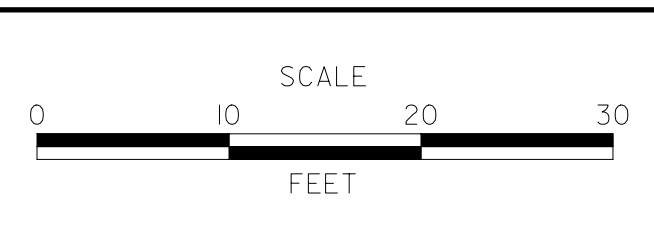

**US 301,
SR 896 TO SR 1**

CONTRACT T200911308	BRIDGE NO.
COUNTY NEW CASTLE	DESIGNED BY: WJD CHECKED BY: MAA

**CROSS SECTIONS
US 301 MAINLINE
STA. 676+50 TO STA. 677+50**

SHEET NO. 17
TOTAL SHTS. 337

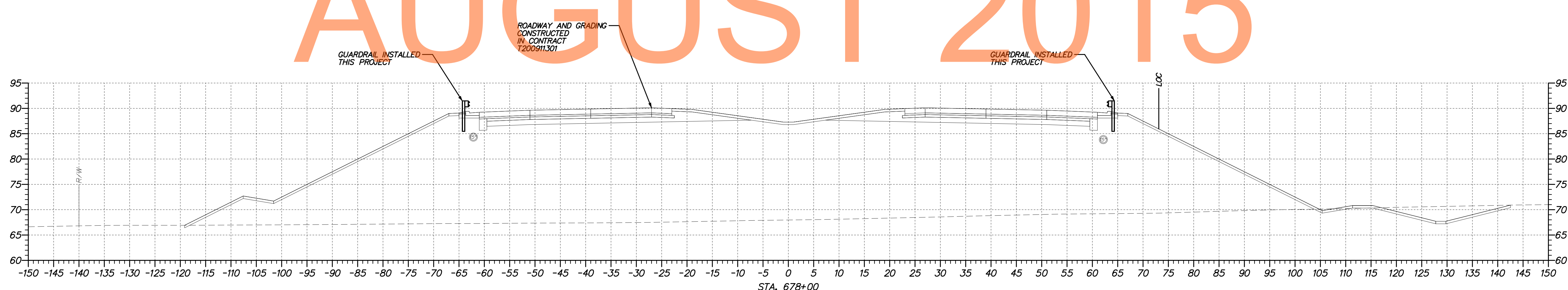
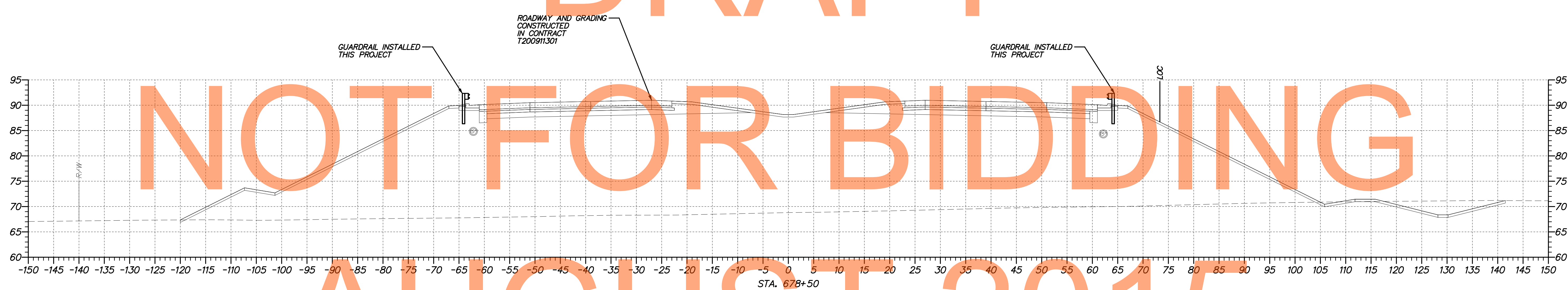
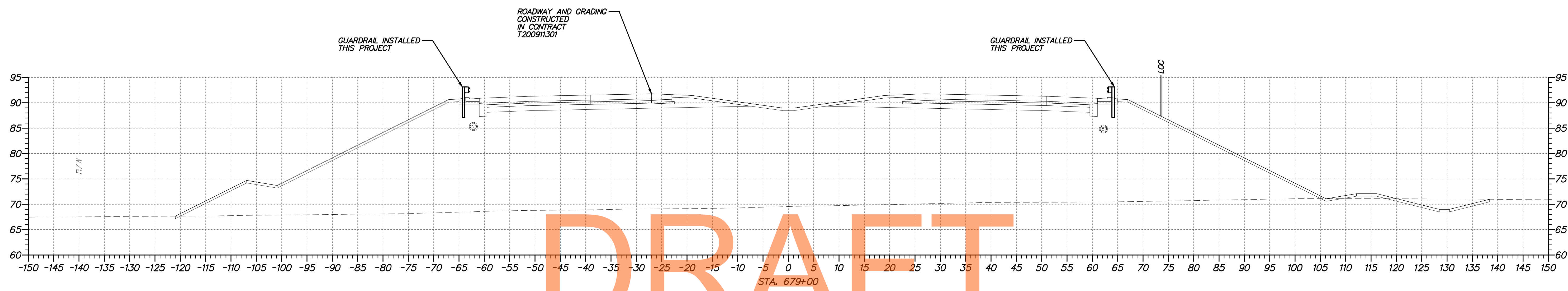

DRAFT

NOT FOR BIDDING

AUGUST 2015

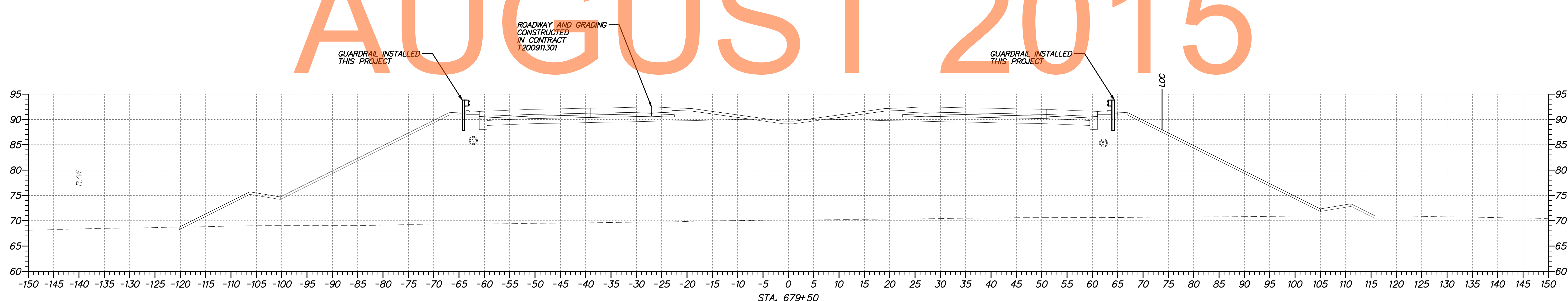
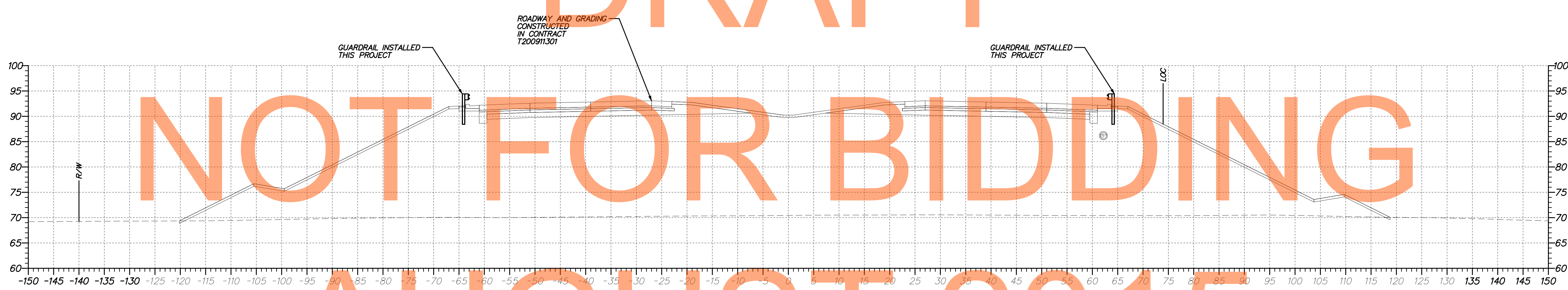
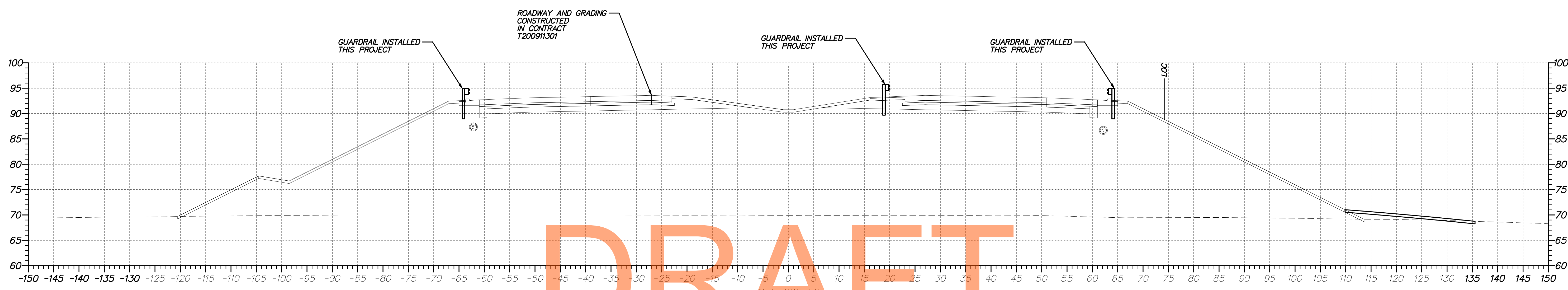

DRAFT
NOT FOR BIDDING
AUGUST 2015



ADDENDUMS / REVISIONS	

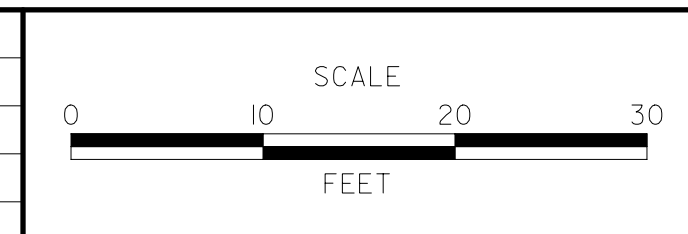

**US 301,
SR 896 TO SR 1**

CONTRACT T200911308	BRIDGE NO.
COUNTY NEW CASTLE	DESIGNED BY: WJD CHECKED BY: MAA

**CROSS SECTIONS
US 301 MAINLINE
STA. 679+50 TO STA. 680+50**

SHEET NO. 19
TOTAL SHTS. 337

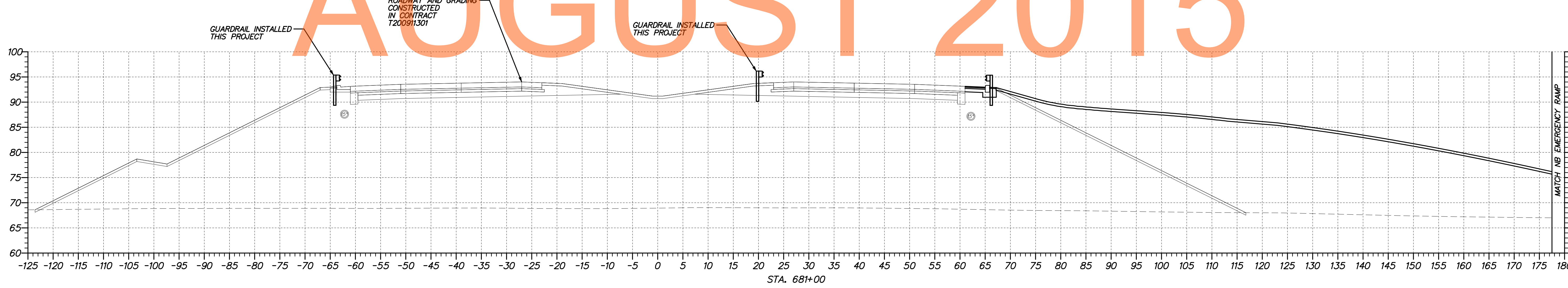
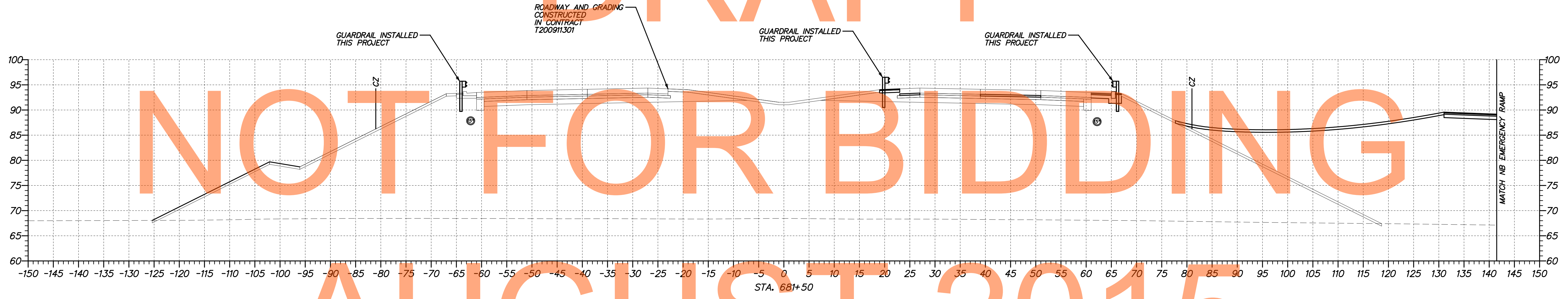
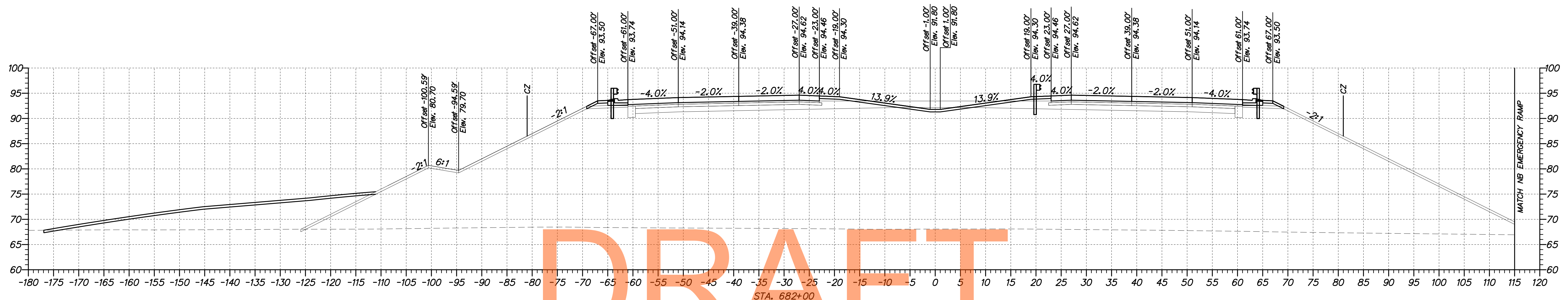

DRAFT
NOT FOR BIDDING
AUGUST 2015

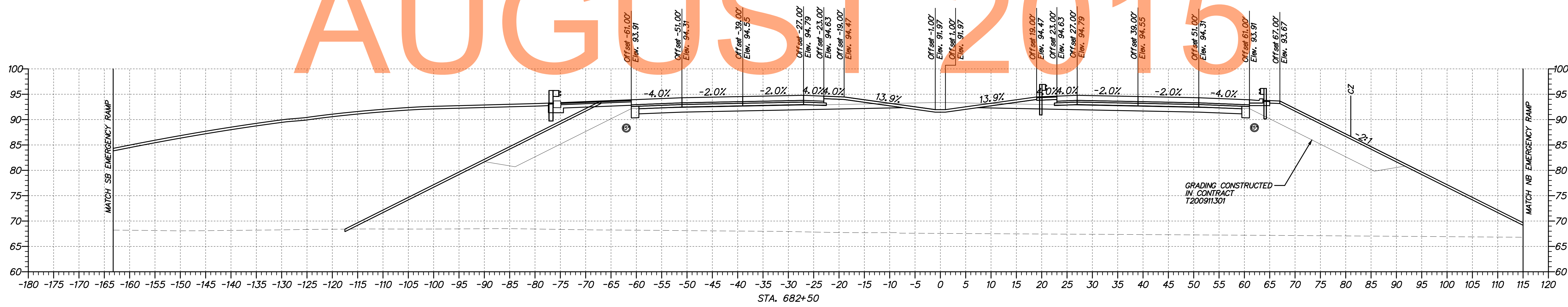
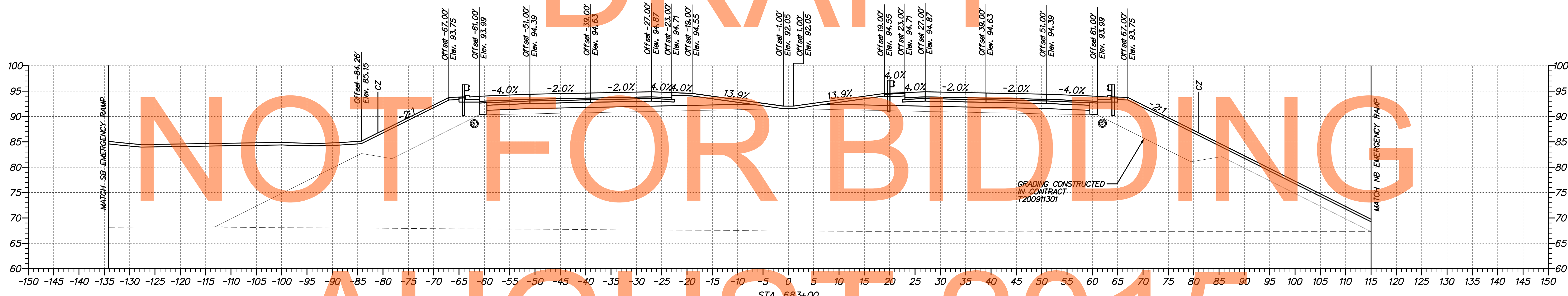
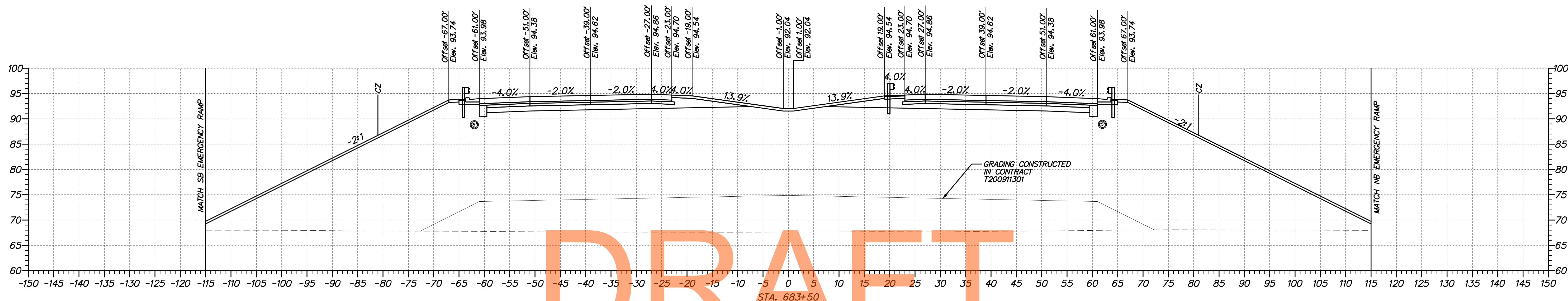

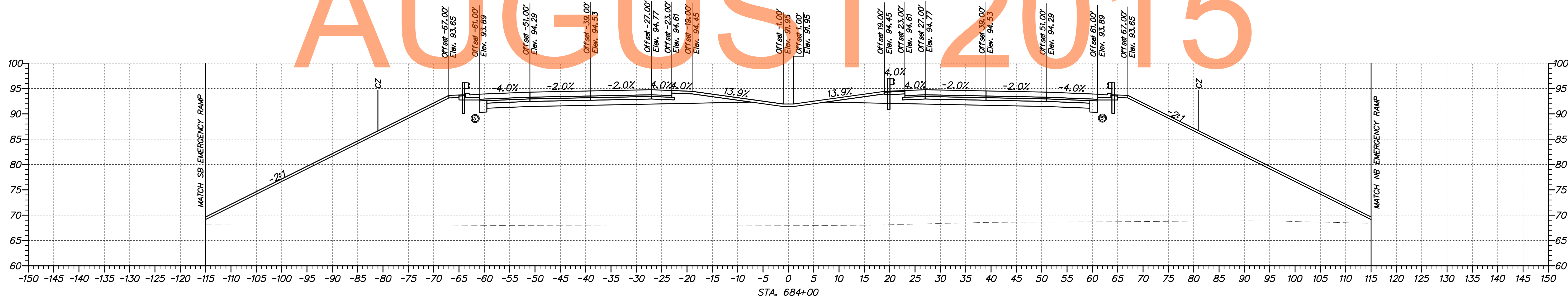
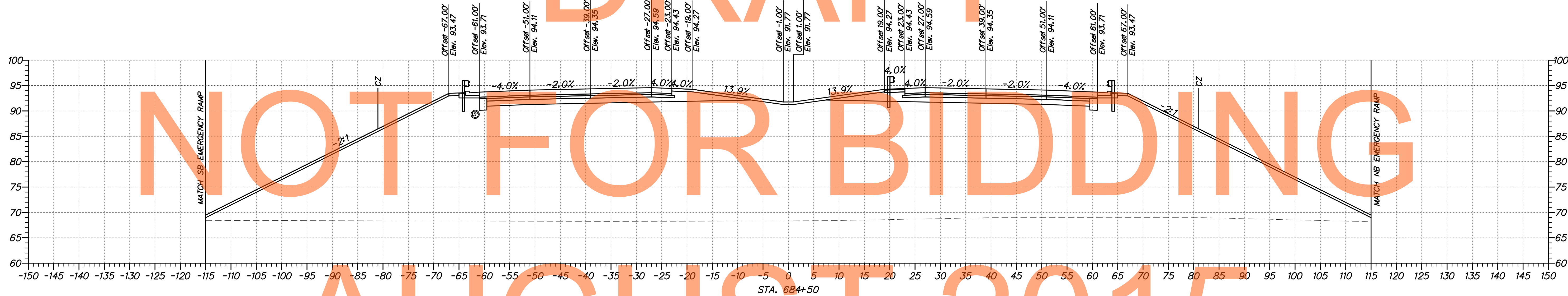
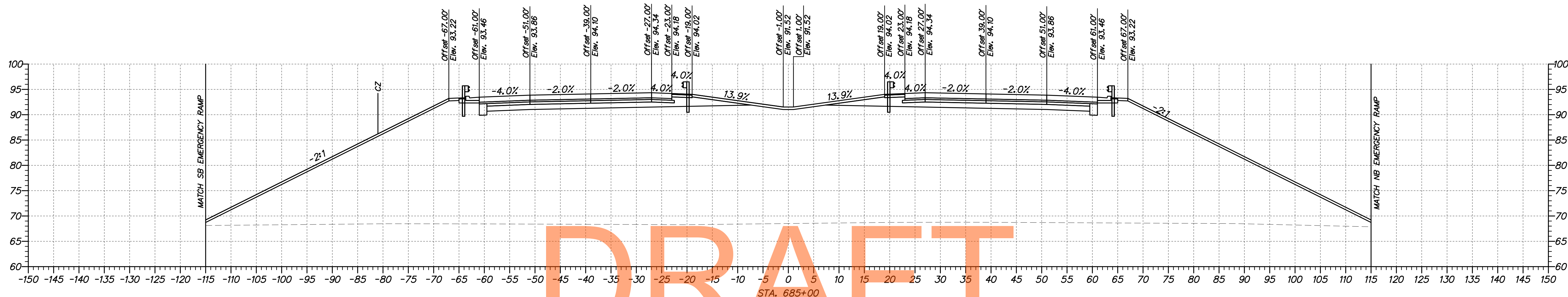

ADDENDUMS / REVISIONS

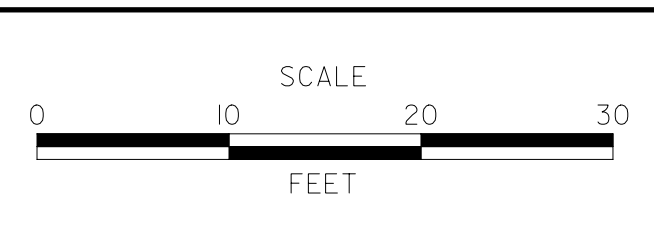

**US 301,
SR 896 TO SR 1**

CONTRACT T200911308	BRIDGE NO.
COUNTY NEW CASTLE	DESIGNED BY: WJD CHECKED BY: MAA

**CROSS SECTIONS
US 301 MAINLINE
STA. 684+00 TO STA. 685+00**

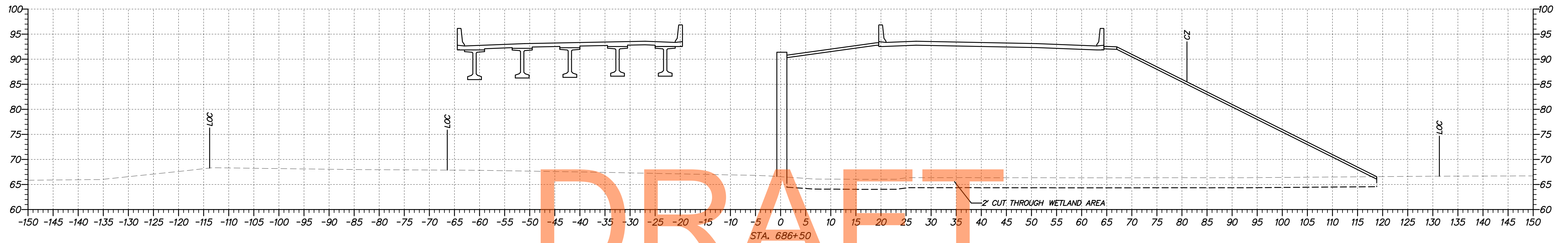

DRAFT

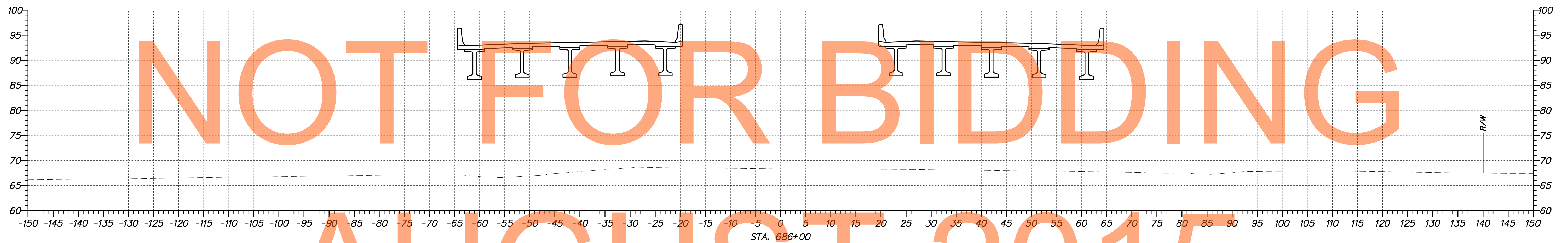

NOT FOR BIDDING

AUGUST 2015

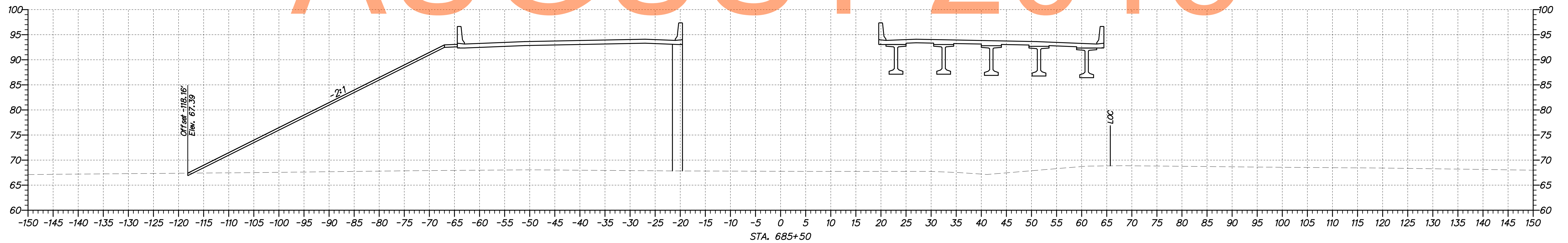

ADDENDUMS / REVISIONS



US 301,
SR 896 TO SR 1

CONTRACT T200911308	BRIDGE NO.
COUNTY NEW CASTLE	DESIGNED BY: WJD
	CHECKED BY: MAA

CROSS SECTIONS
US 301 MAINLINE
STA. 685+50 TO STA. 686+50

SHEET NO. 23
TOTAL SHTS. 337

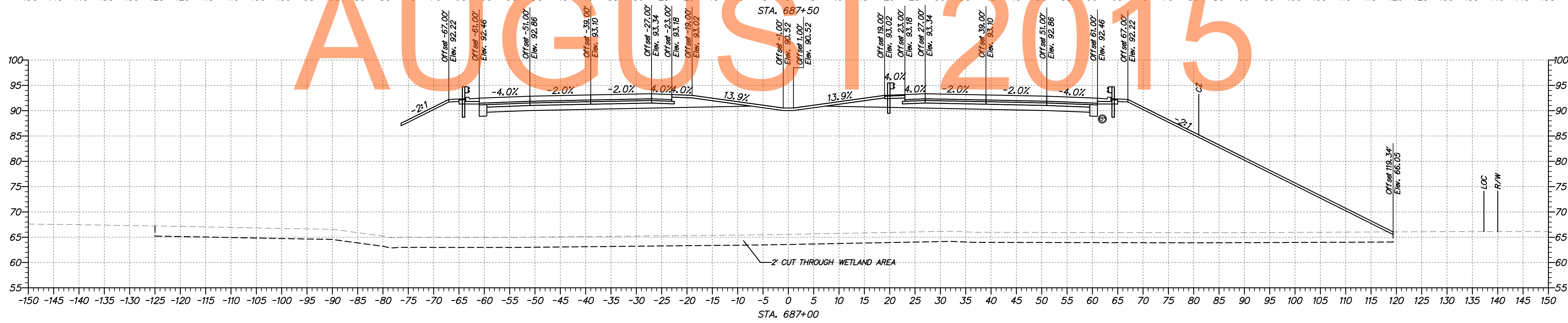
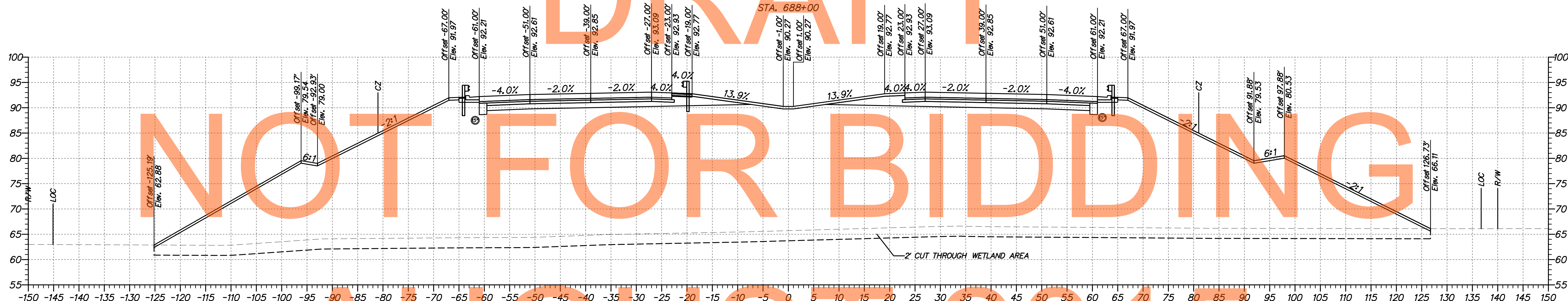
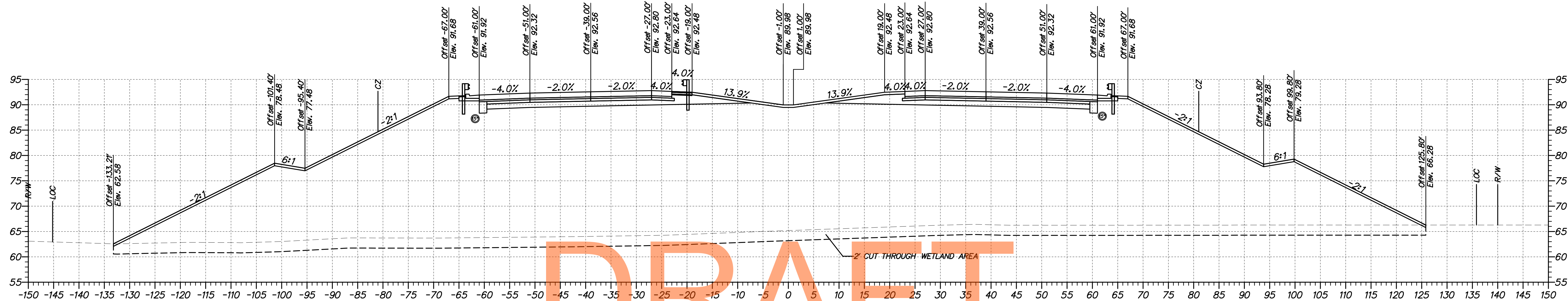

ADDENDUMS / REVISIONS

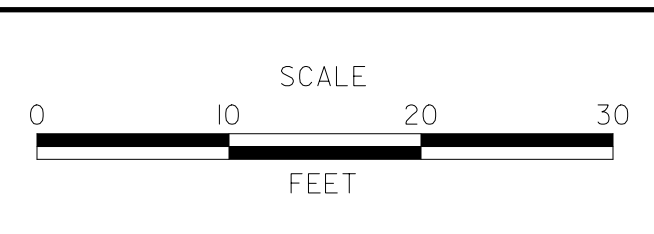

**US 301,
SR 896 TO SR 1**

CONTRACT T200911308	BRIDGE NO.
COUNTY NEW CASTLE	DESIGNED BY: WJD
	CHECKED BY: MAA

**CROSS SECTIONS
US 301 MAINLINE
STA. 687+00 TO STA. 688+00**

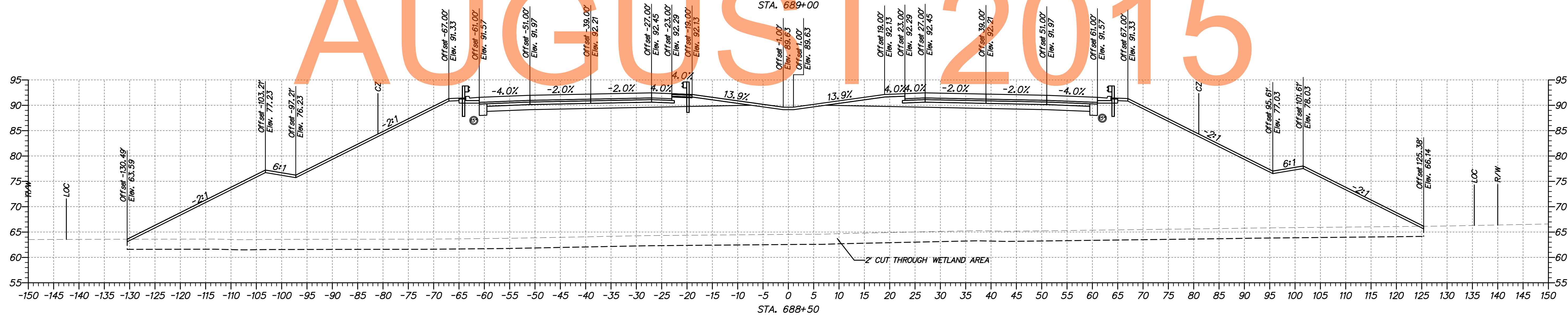
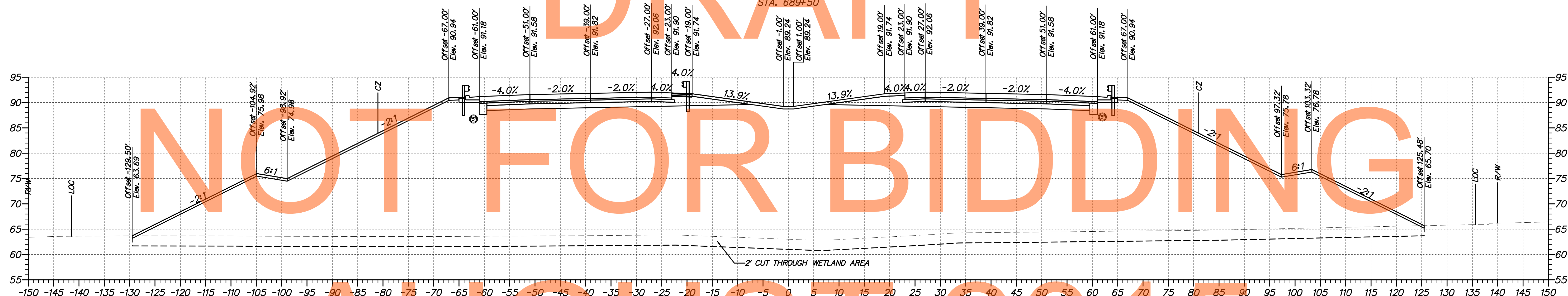
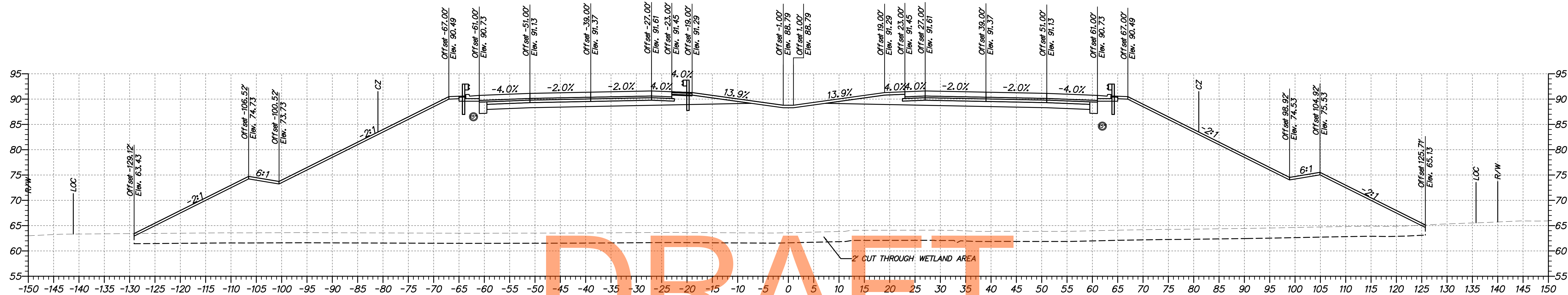

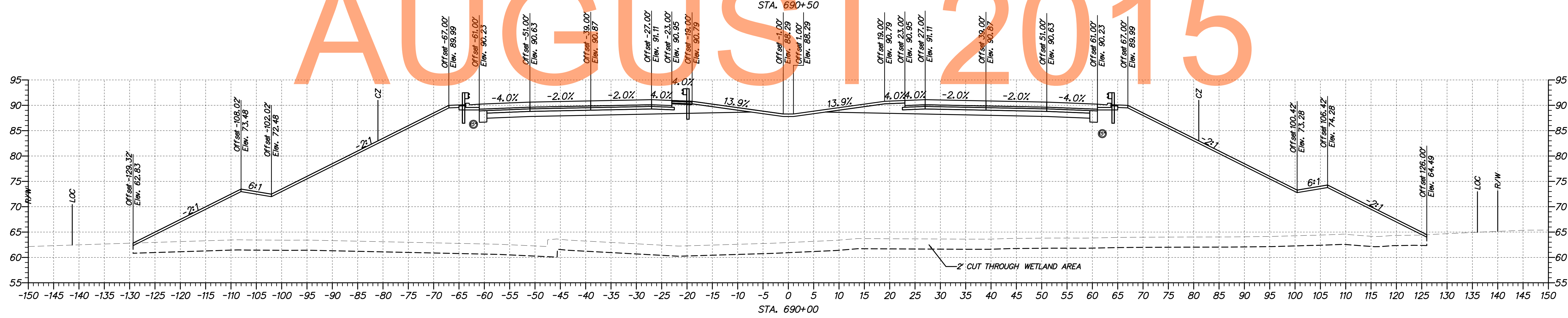
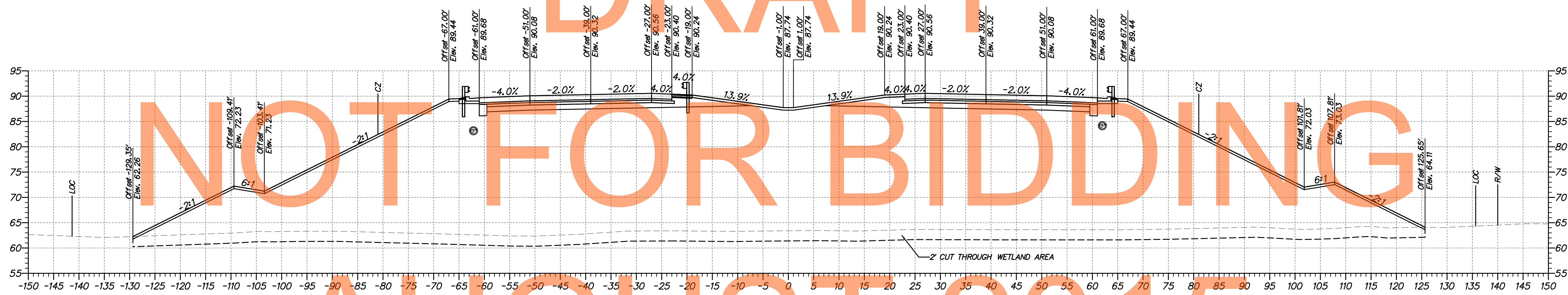
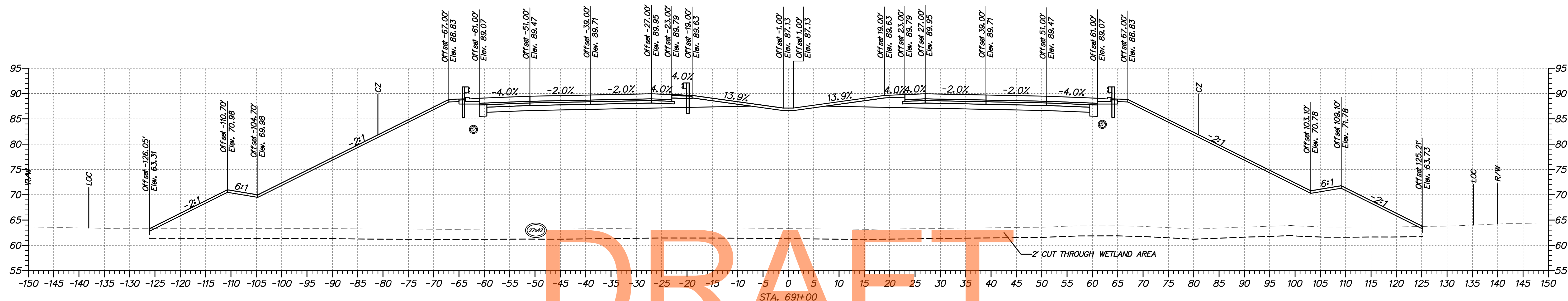

ADDENDUMS / REVISIONS	

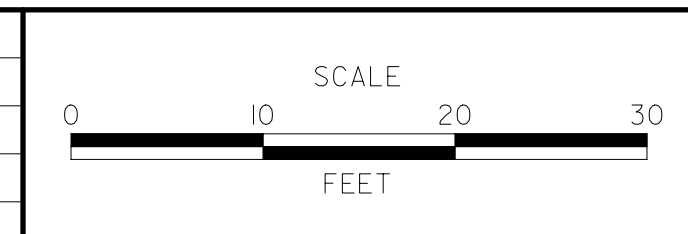

**US 301,
SR 896 TO SR 1**

CONTRACT T200911308	BRIDGE NO.
COUNTY NEW CASTLE	DESIGNED BY: WJD
	CHECKED BY: MAA

**CROSS SECTIONS
US 301 MAINLINE
STA. 690+00 TO STA. 691+00**

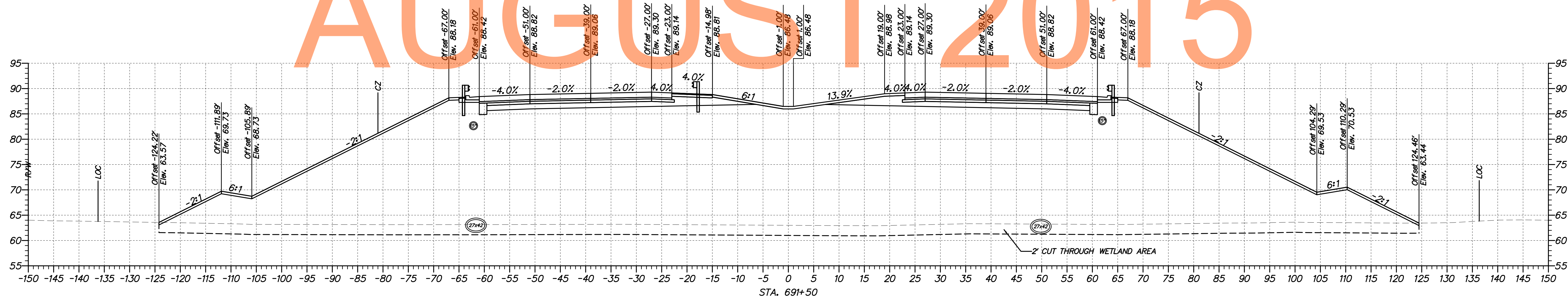
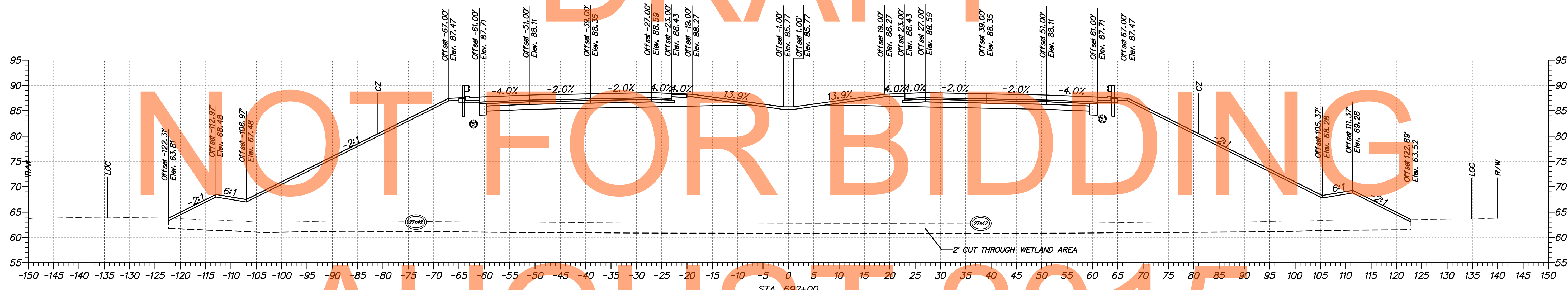
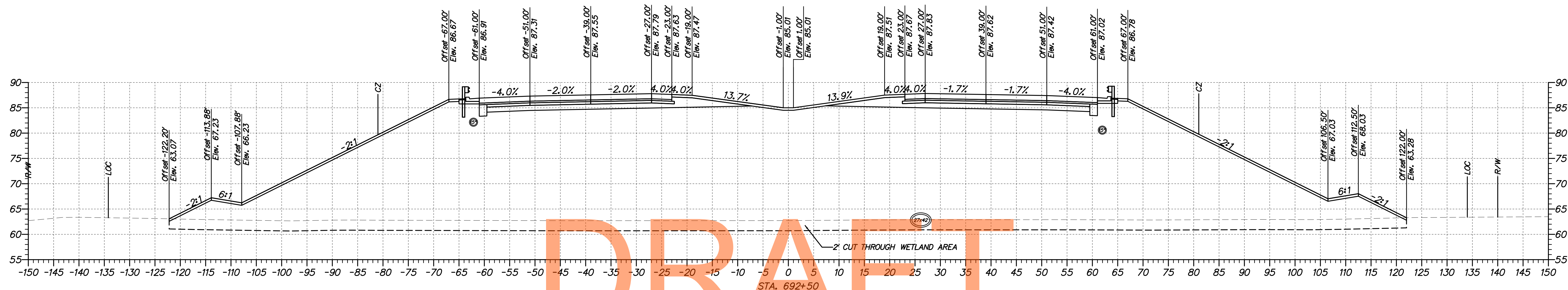

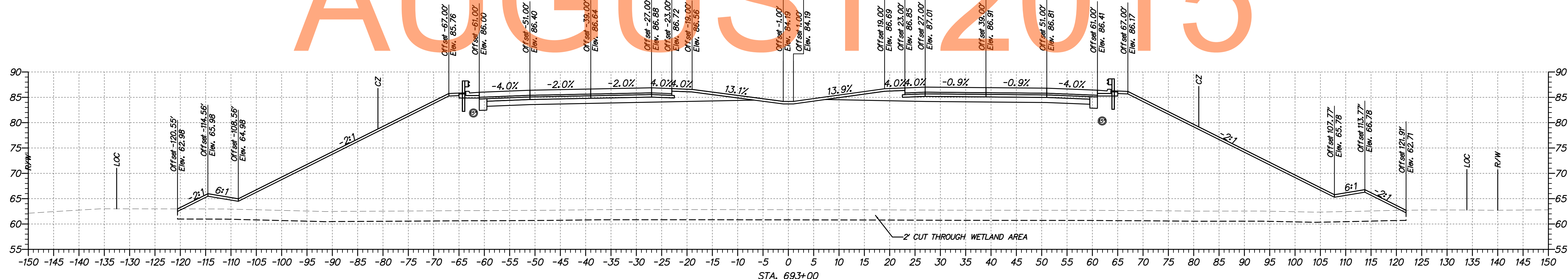
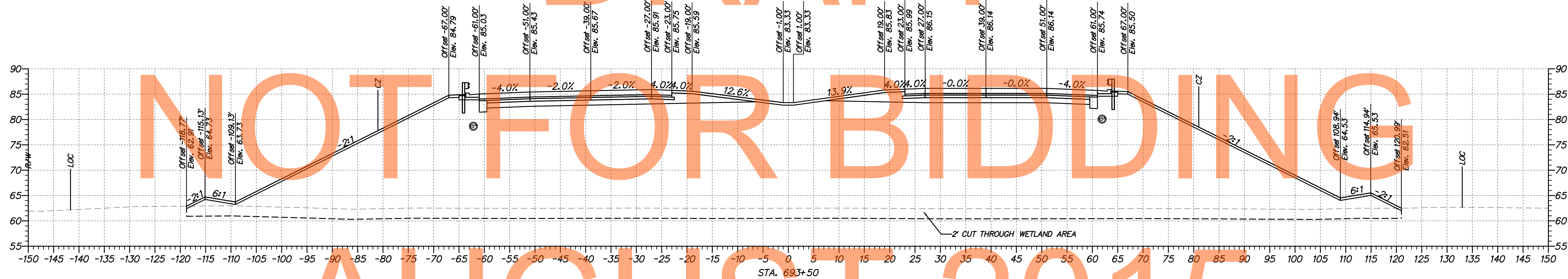
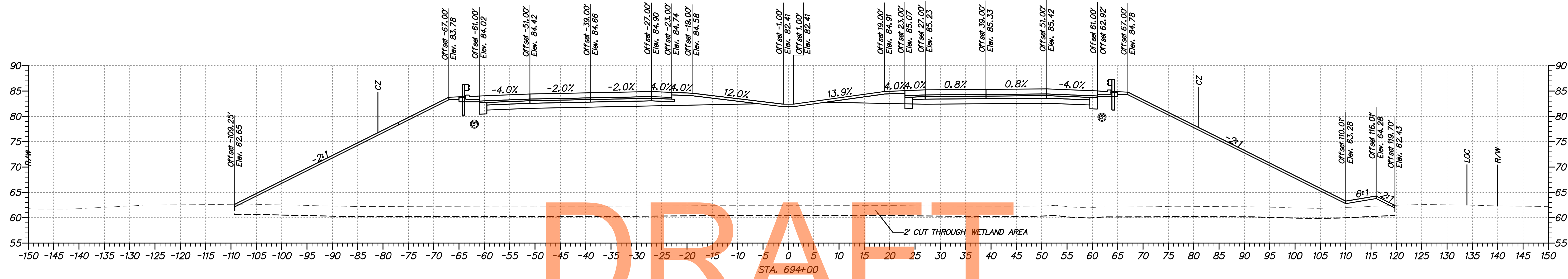

ADDENDUMS / REVISIONS

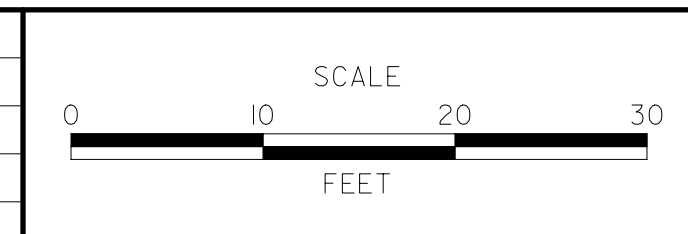

**US 301,
SR 896 TO SR 1**

CONTRACT T200911308	BRIDGE NO.
COUNTY NEW CASTLE	DESIGNED BY: WJD CHECKED BY: MAA

**CROSS SECTIONS
US 301 MAINLINE
STA. 693+00 TO STA. 694+00**

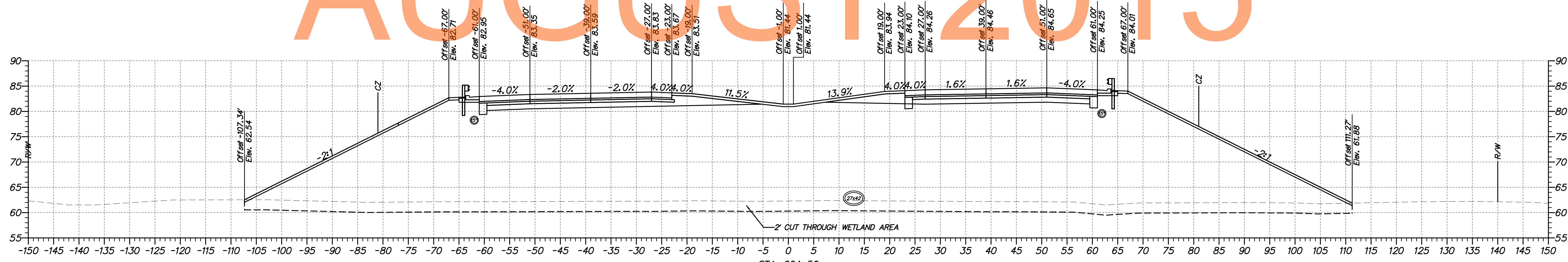
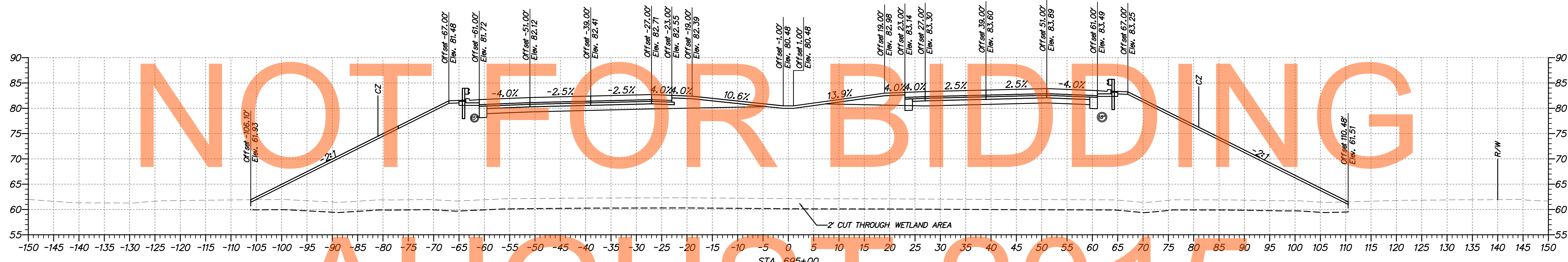
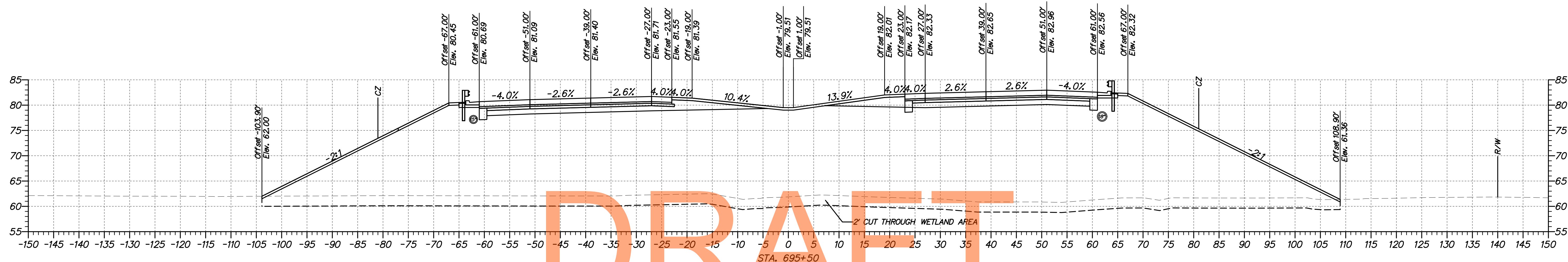

ADDENDUMS / REVISIONS

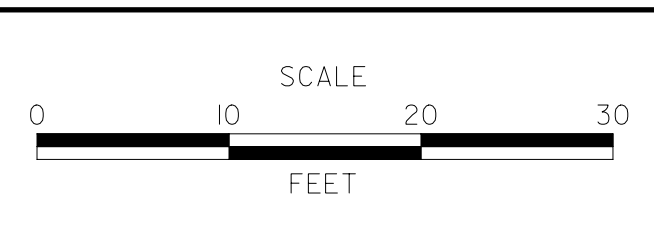

US 301,
SR 896 TO SR 1

CONTRACT T200911308	BRIDGE NO.
COUNTY NEW CASTLE	DESIGNED BY: WJD
	CHECKED BY: MAA

CROSS SECTIONS
US 301 MAINLINE
STA. 694+50 TO STA. 695+50

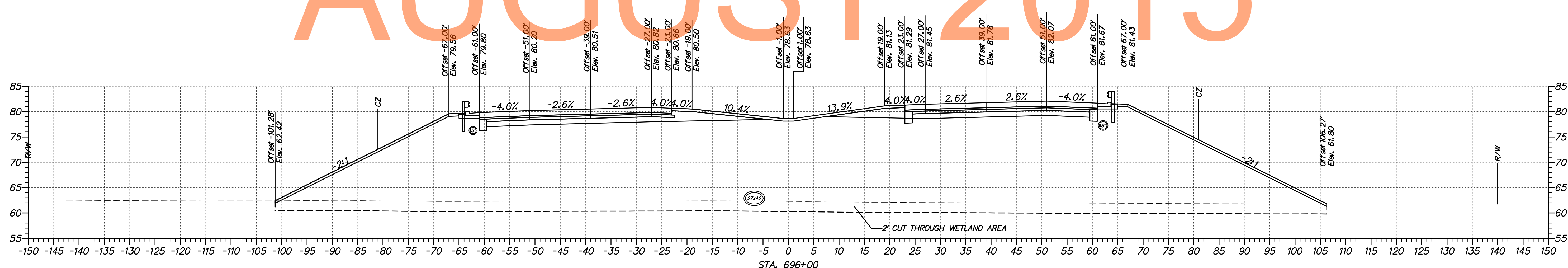
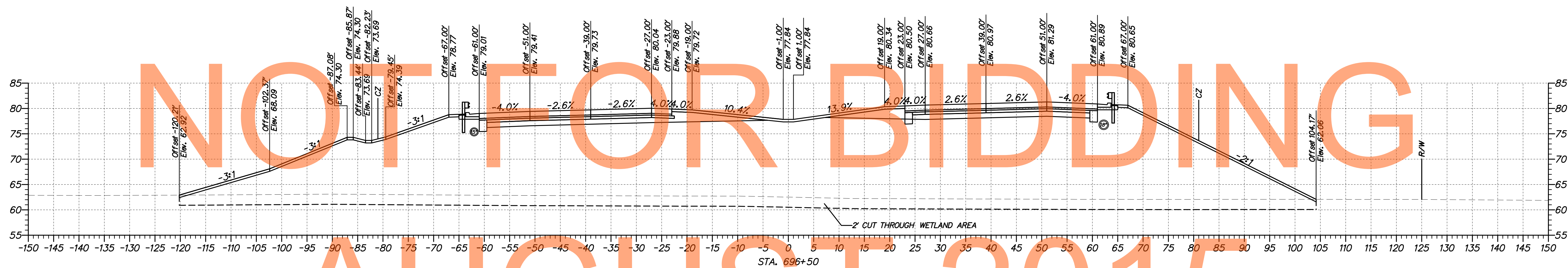
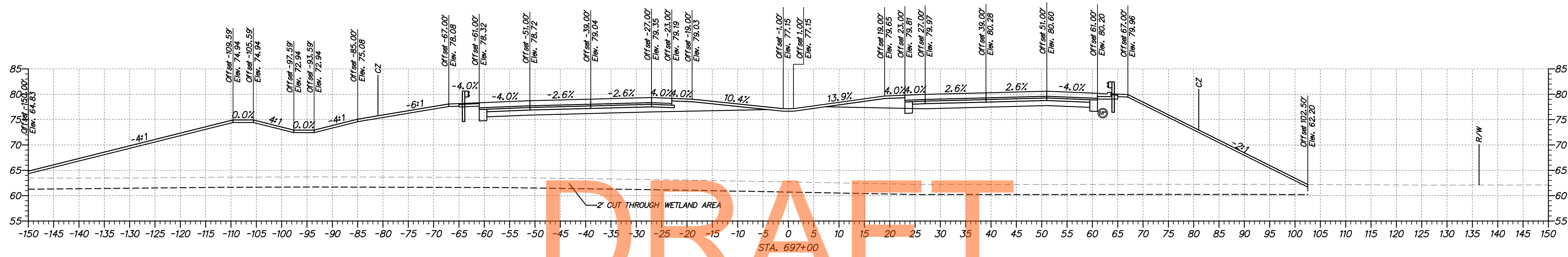

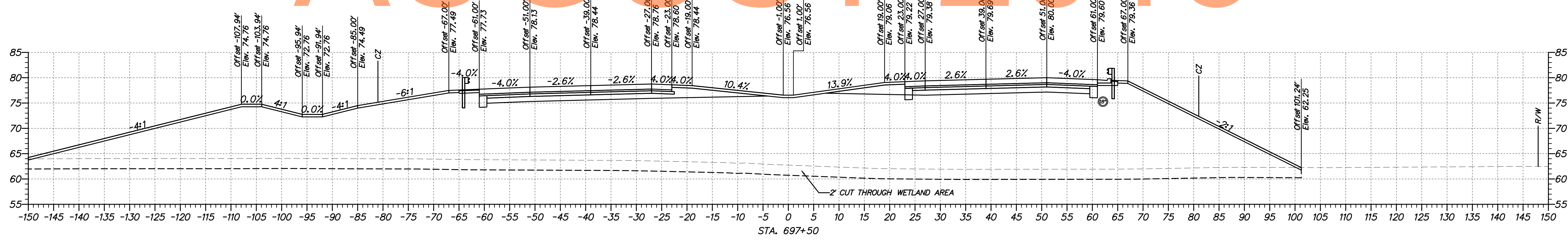
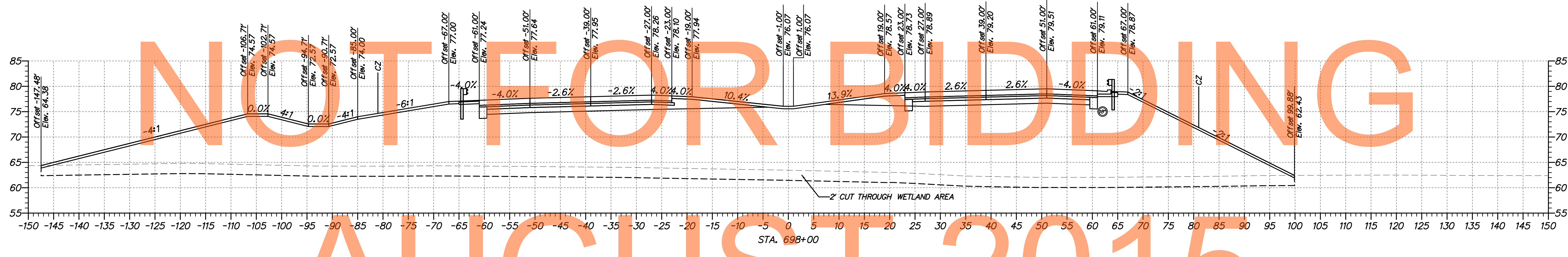
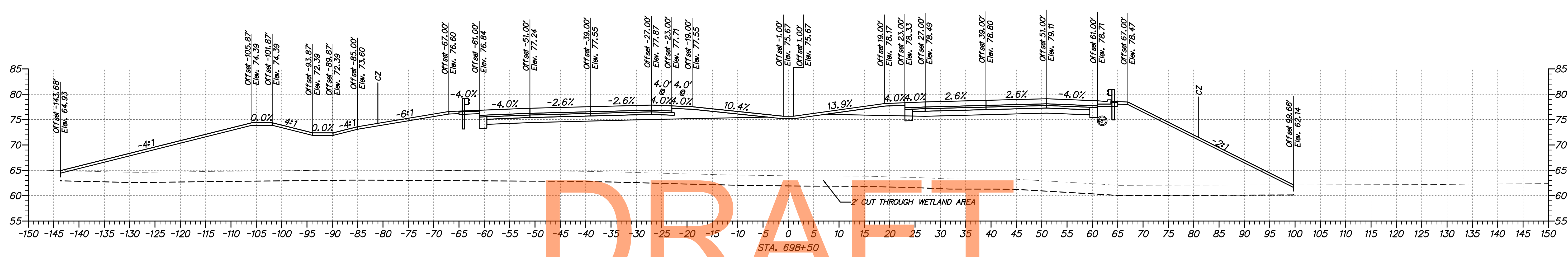

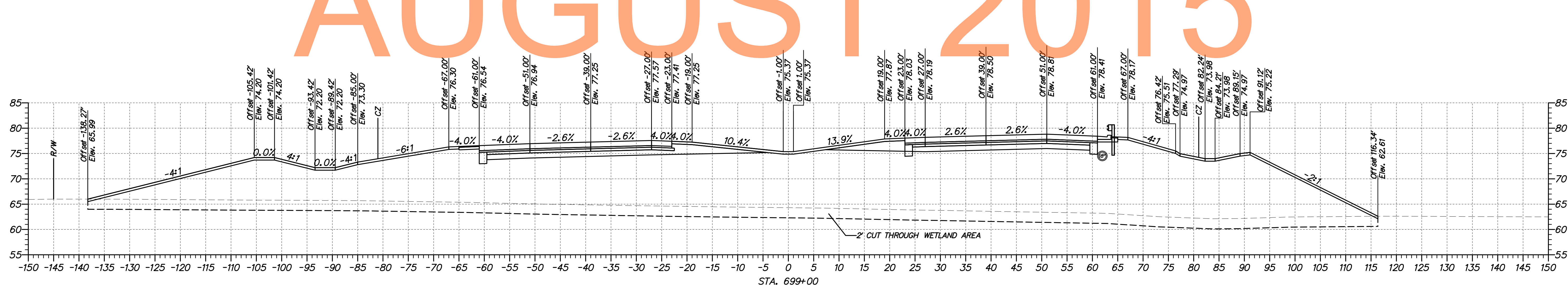
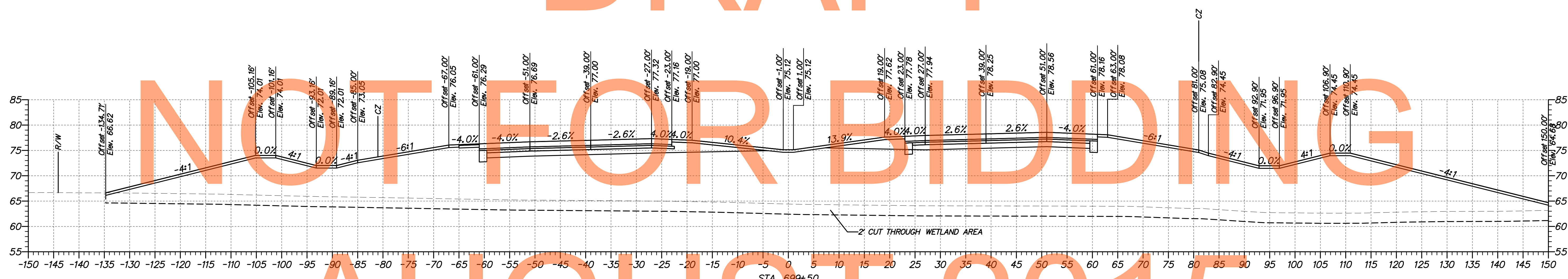
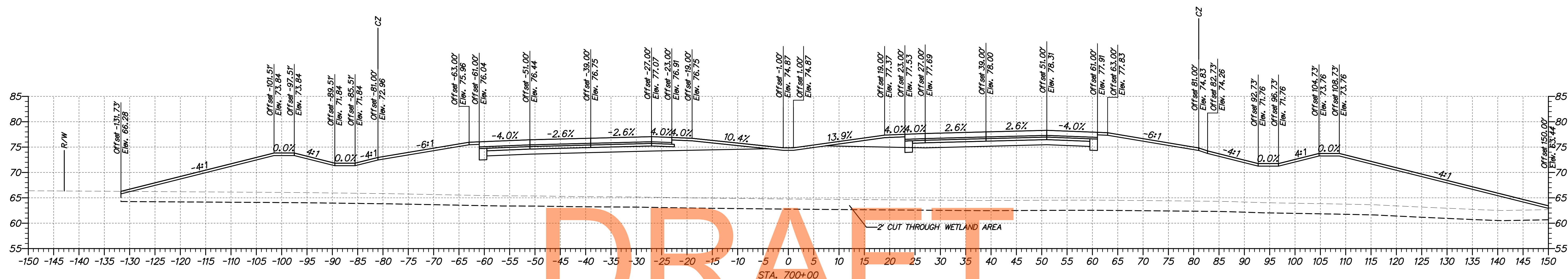

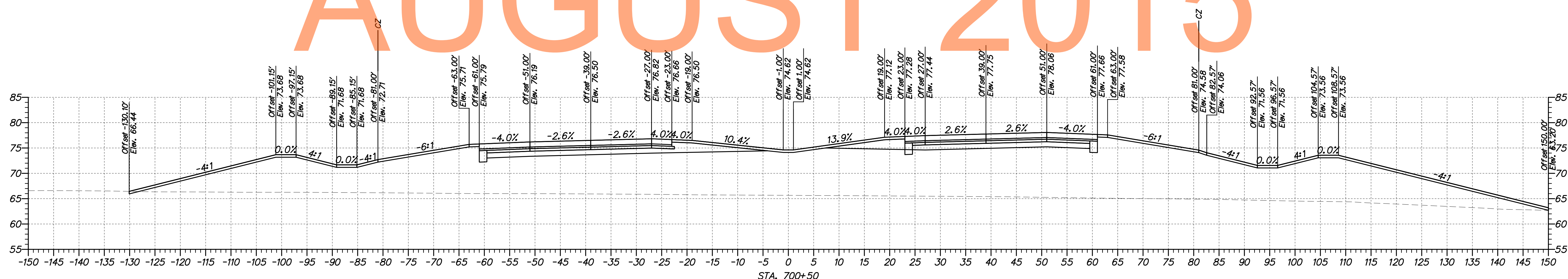
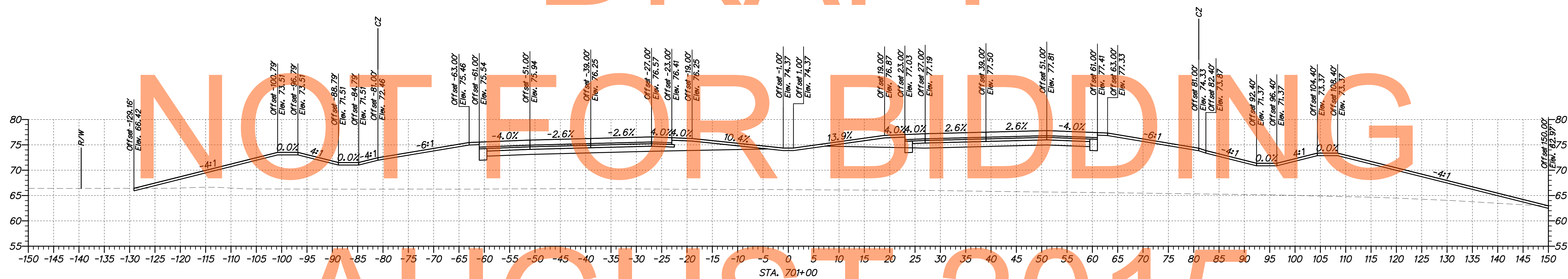
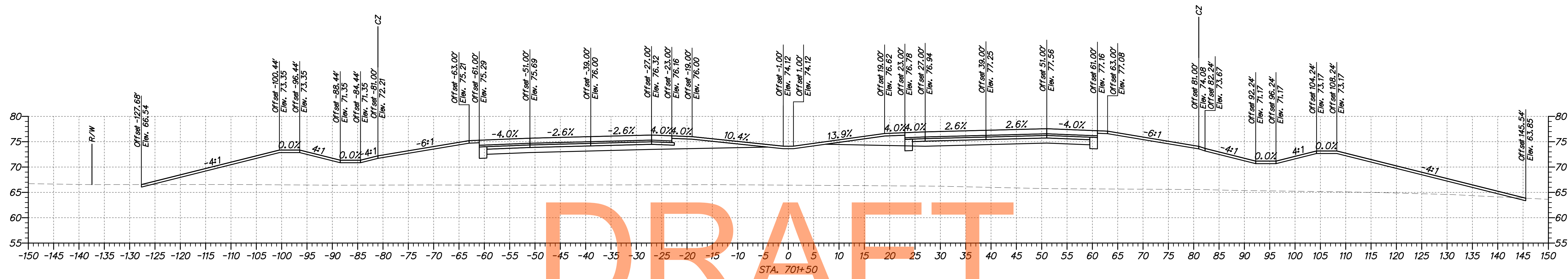

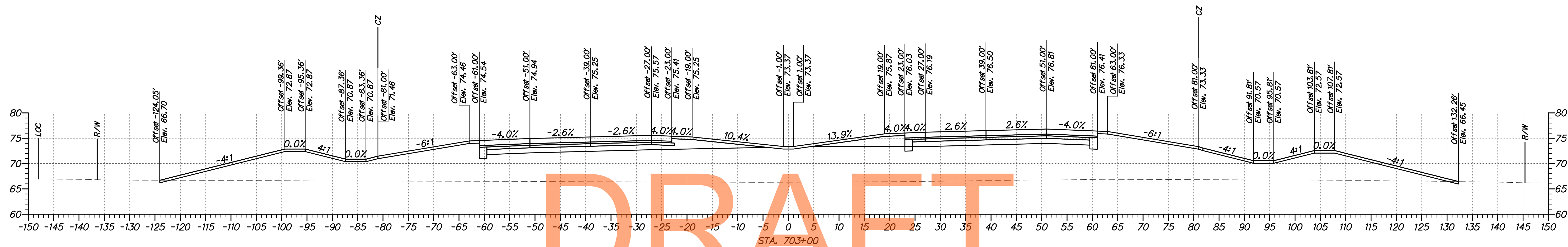

STA. 703+00

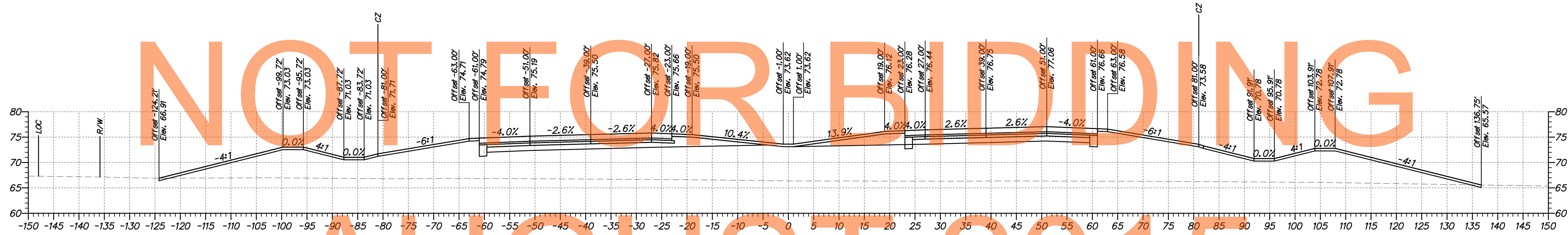

STA. 702+50

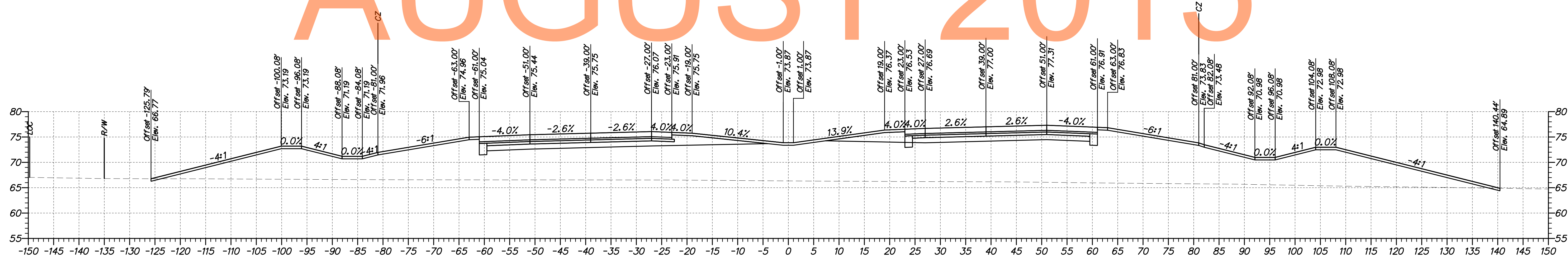

STA. 702+00



ADDENDUMS / REVISIONS



US 301,
SR 896 TO SR 1

CONTRACT	BRIDGE NO.
T200911308	
COUNTY	DESIGNED BY: WJD
NEW CASTLE	CHECKED BY: MAA

CROSS SECTIONS
US 301 MAINLINE
STA. 702+00 TO STA. 703+00

SHEET NO.
34
TOTAL SHTS.
337

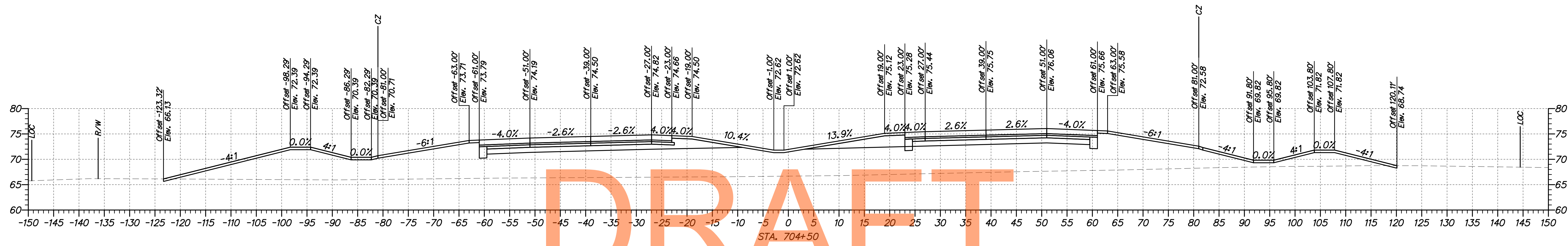

DRAFT

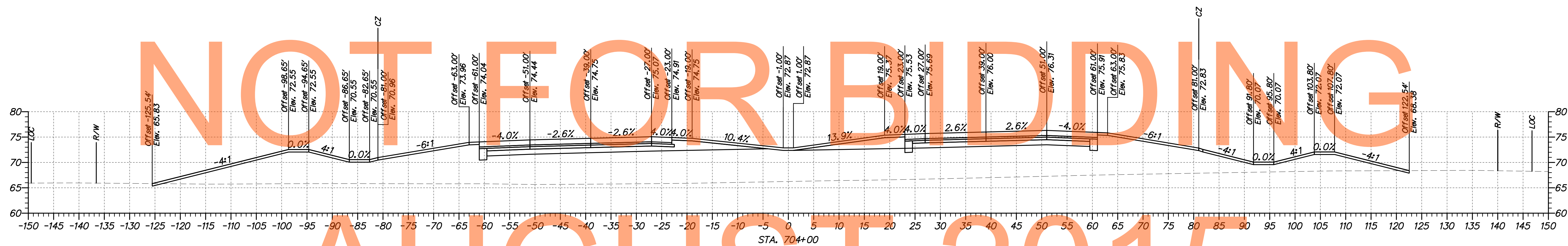

NOT FOR BIDDING

AUGUST 2015

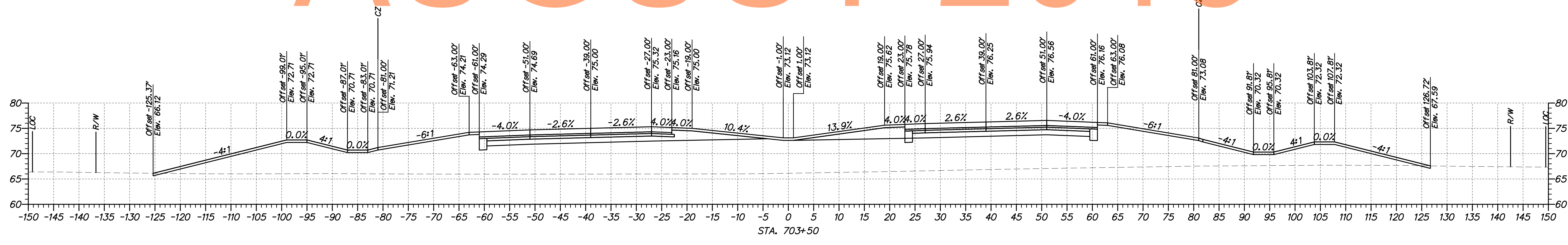

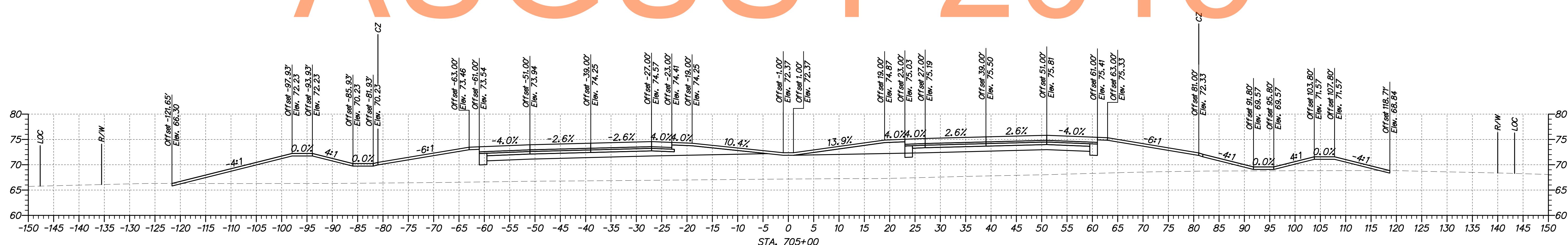
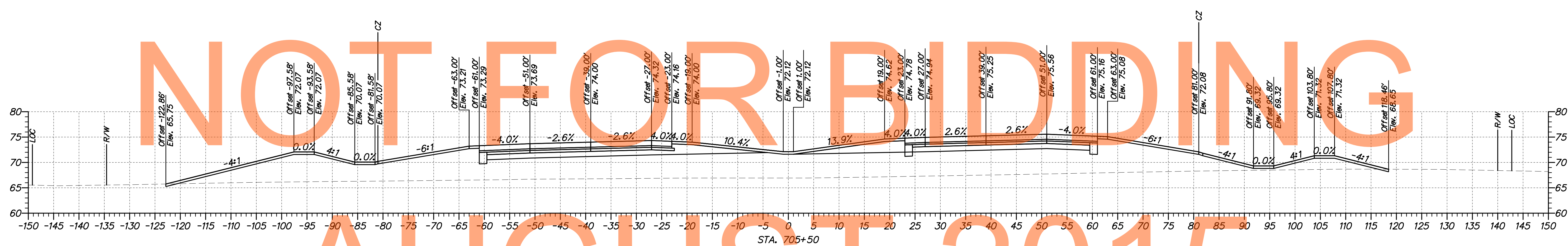
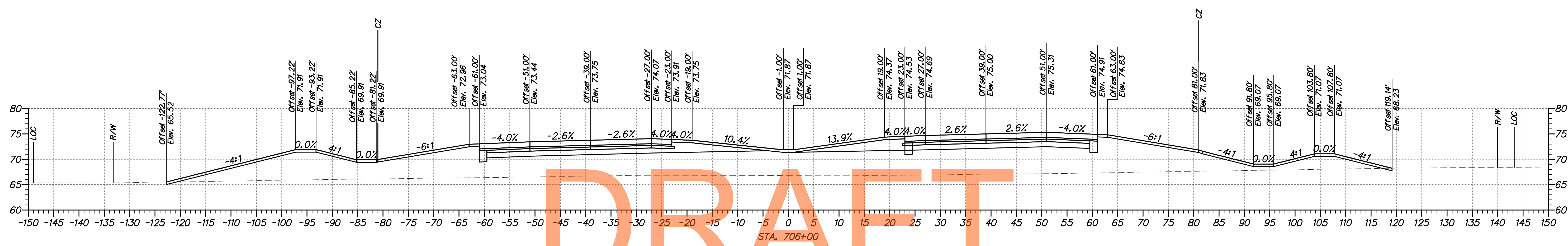

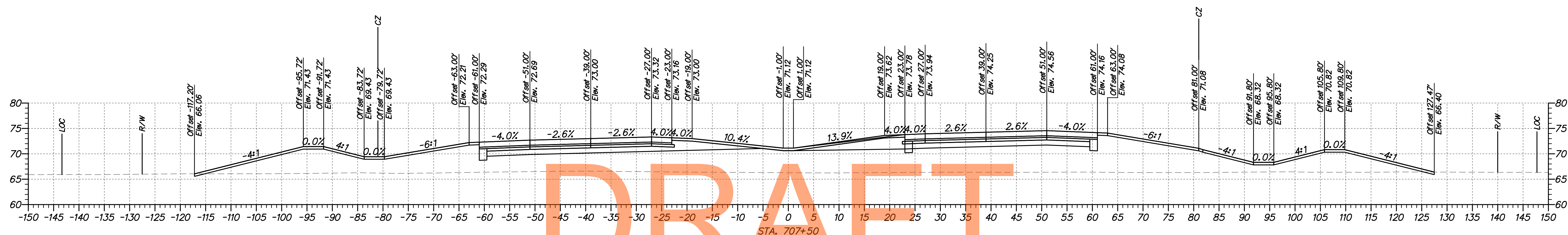

DRAFT

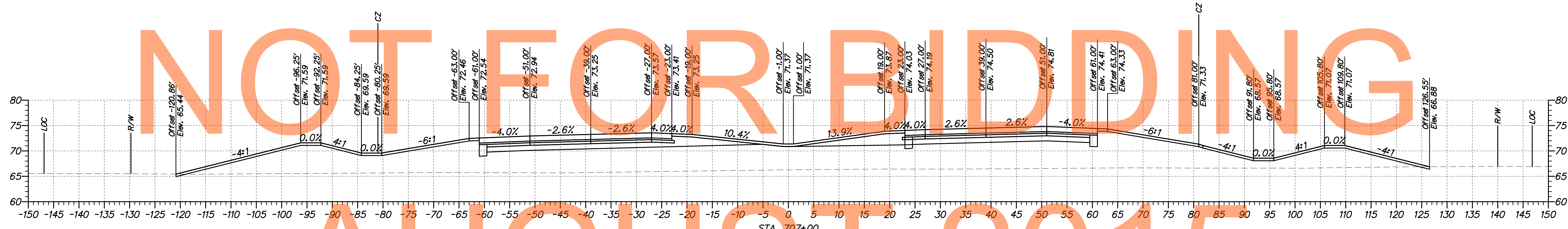

AUGUST 2015

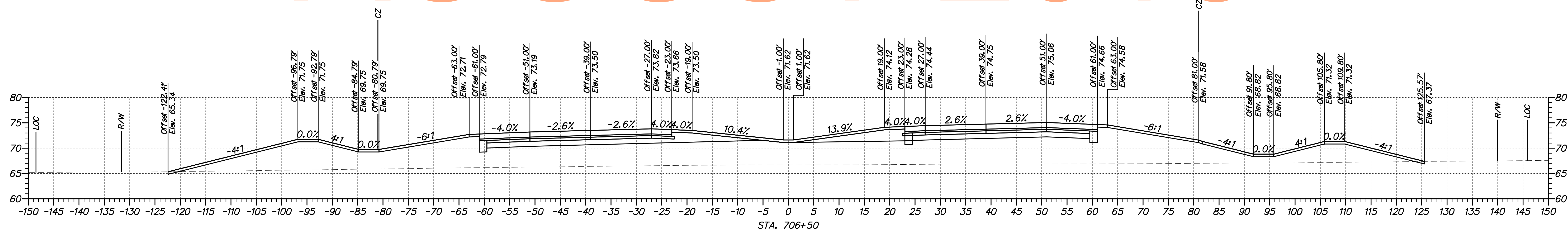

ADDENDUMS / REVISIONS	

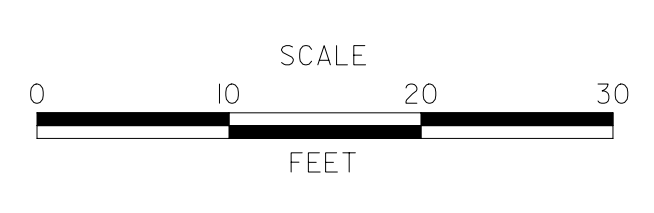

**US 301,
SR 896 TO SR 1**

CONTRACT T200911308	BRIDGE NO.
COUNTY NEW CASTLE	DESIGNED BY: WJD
	CHECKED BY: MAA

**CROSS SECTIONS
US 301 MAINLINE
STA. 706+50 TO STA. 707+50**

SHEET NO. 37
TOTAL SHTS. 337

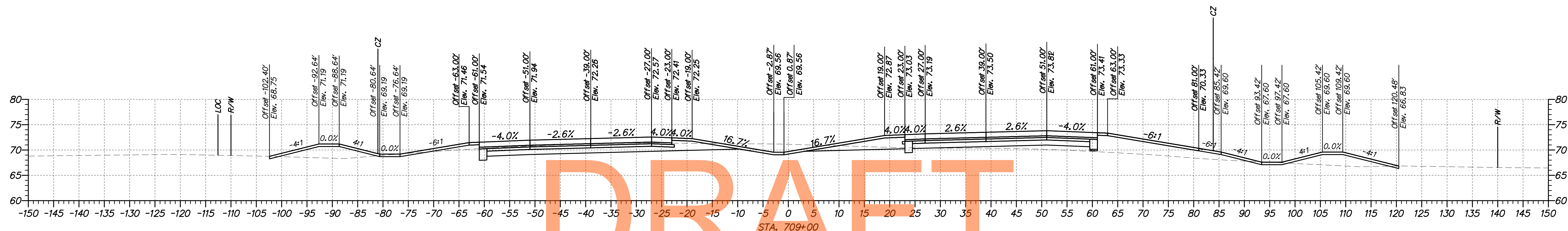

DRAFT

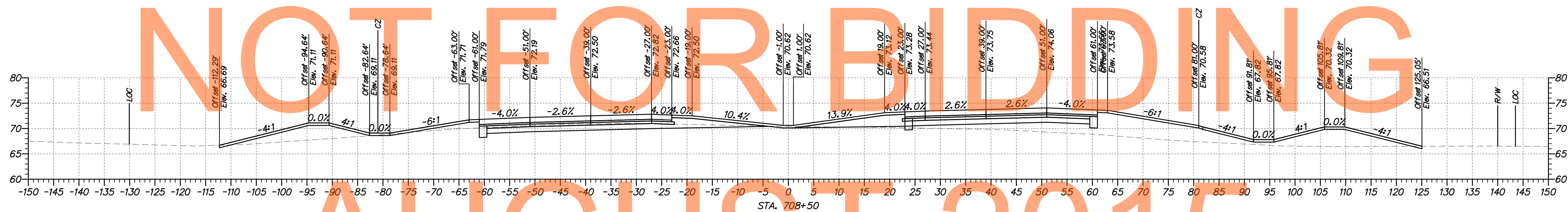

AUGUST 2015

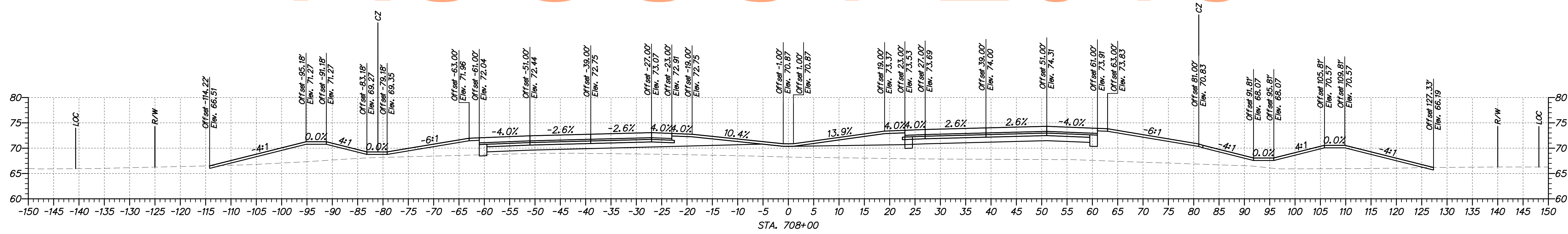

NOT FOR BIDDING

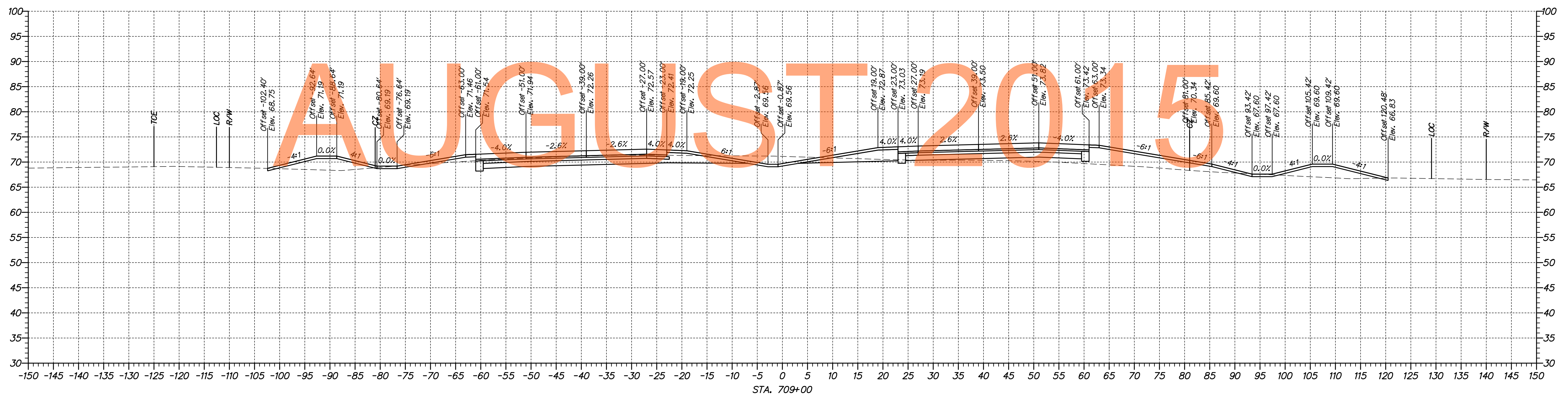
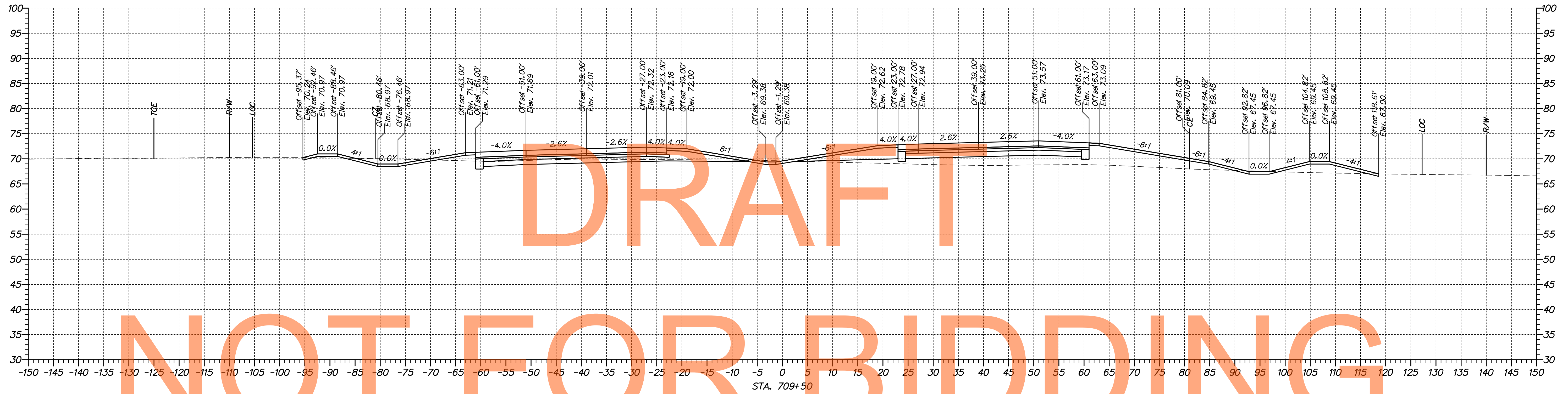

n:\1653-000\semitract\locadd\XS002\301_LA_70900-74850.dgn
 07/30/2014 10:55:57 AM



ADDENDUMS / REVISIONS	

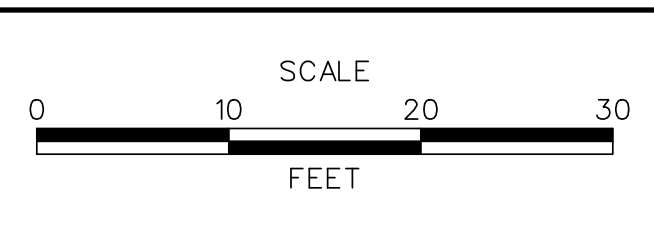

**US 301,
SR 896 TO SR 1**

CONTRACT	BRIDGE NO.
T200911308	DESIGNED BY: MEF
COUNTY	CHECKED BY: TAO
NEW CASTLE	

**CROSS SECTIONS
US 301 MAINLINE**

SHEET NO.
39
TOTAL SHTS.
337

DRAFT

NOT FOR BIDDING

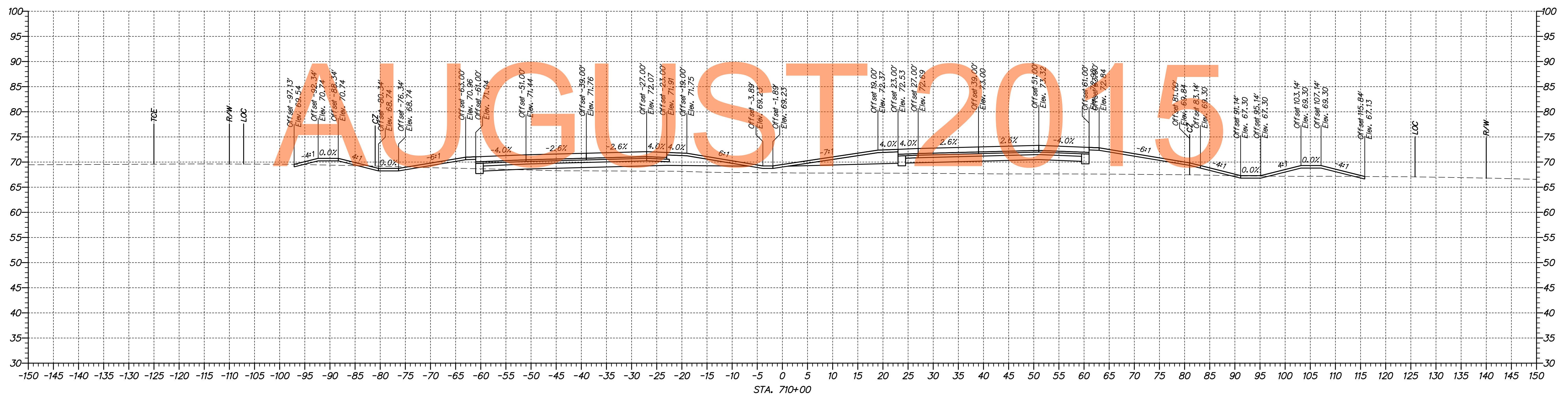
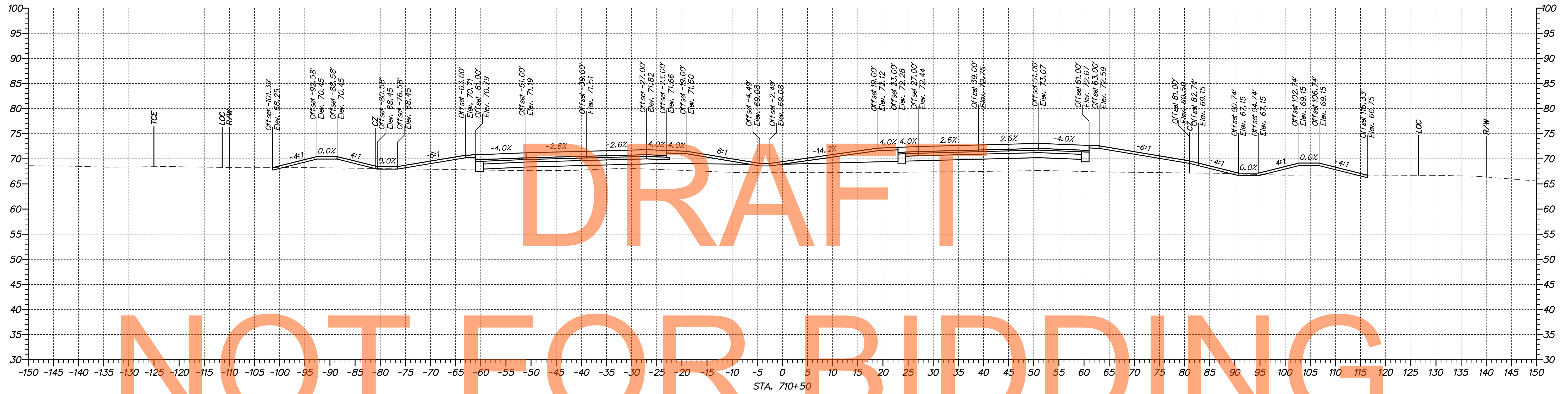

p:\1653-000\sect\sect\loc\add\XS002\301_LA_70900-74850.dgn
 07/30/2014 10:16:00 AM



ADDENDUMS / REVISIONS	

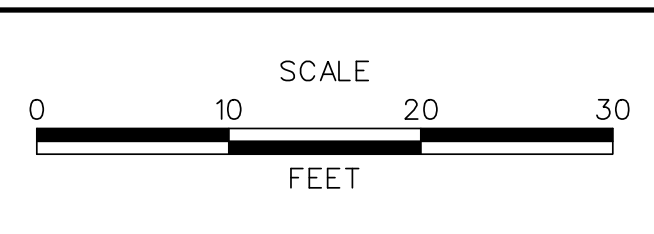

**US 301,
SR 896 TO SR 1**

CONTRACT T200911308	BRIDGE NO.
COUNTY NEW CASTLE	DESIGNED BY: MEF
	CHECKED BY: TAO

**CROSS SECTIONS
US 301 MAINLINE**

SHEET NO. 40
TOTAL SHTS. 337

NOT FOR BIDDING

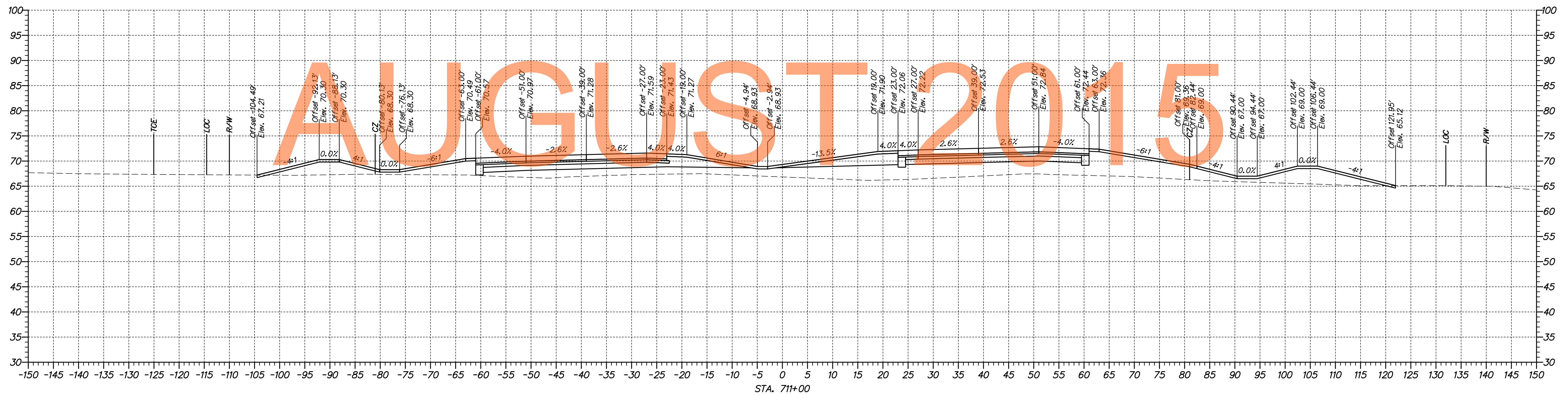
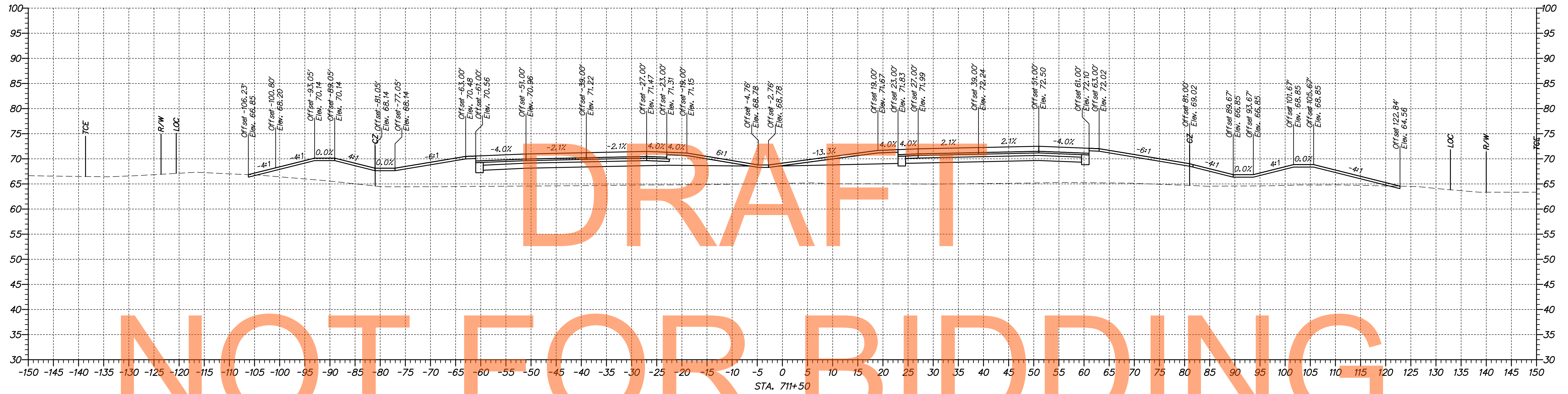

n:\1653-000\semitract\la\cead\XS002\301_LA_70900-74850.dgn
 09/30/2014 10:06:02 AM



ADDENDUMS / REVISIONS	

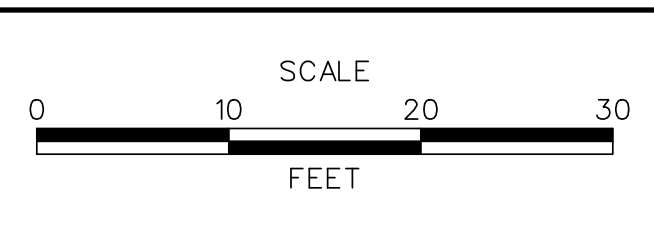

**US 301,
SR 896 TO SR 1**

CONTRACT	BRIDGE NO.
T200911308	
COUNTY	DESIGNED BY: MEF
NEW CASTLE	CHECKED BY: TAO

**CROSS SECTIONS
US 301 MAINLINE**

SHEET NO.	41
TOTAL SHTS.	337

DRAFT

NOT FOR BIDDING

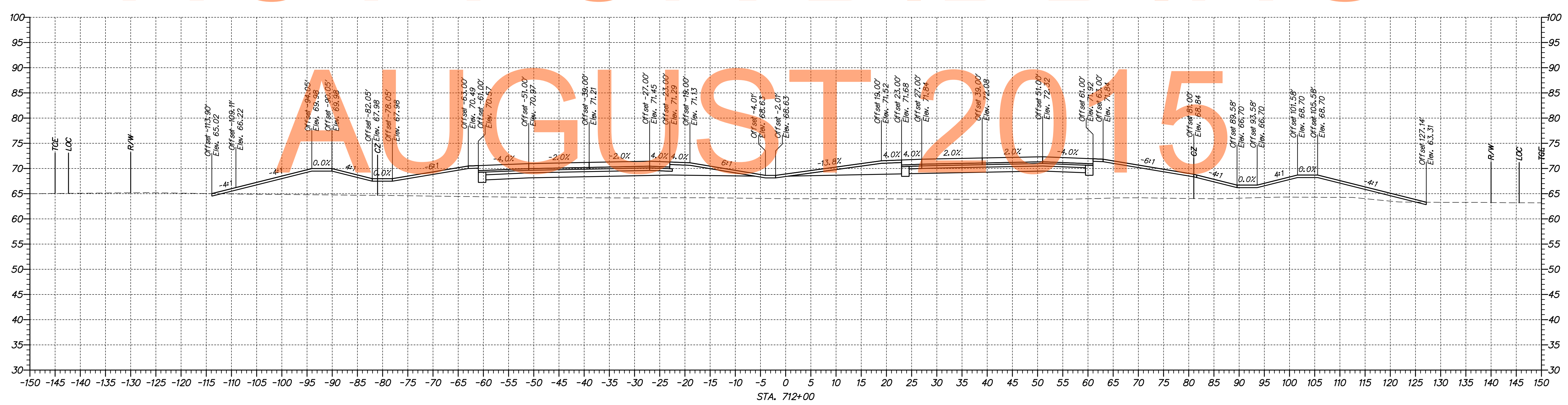
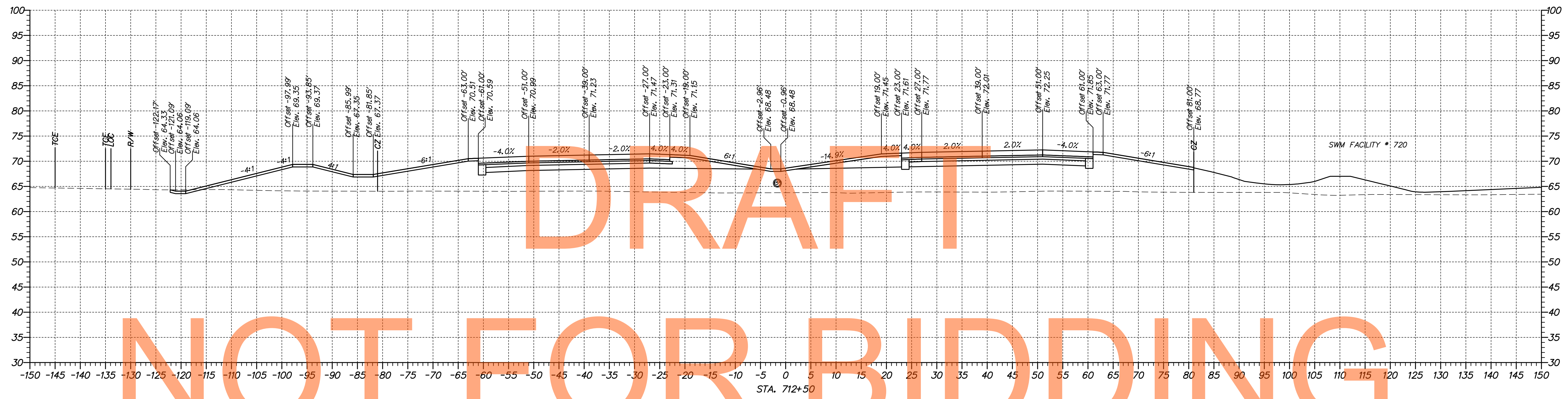

\\03653-000\sem\project\la\cadd\XS002\301_LA_70900-74850.dgn 09/30/2014 10:06:05 AM



ADDENDUMS / REVISIONS	

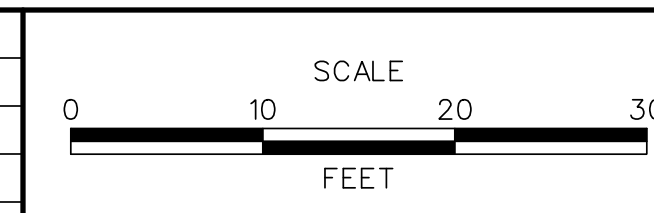

US 301,
SR 896 TO SR 1

CONTRACT T200911308	BRIDGE NO.
COUNTY NEW CASTLE	DESIGNED BY: MEF
	CHECKED BY: TAO

CROSS SECTIONS
US 301 MAINLINE

SHEET NO. 42
TOTAL SHTS. 337

DRAFT

NOT FOR BIDDING

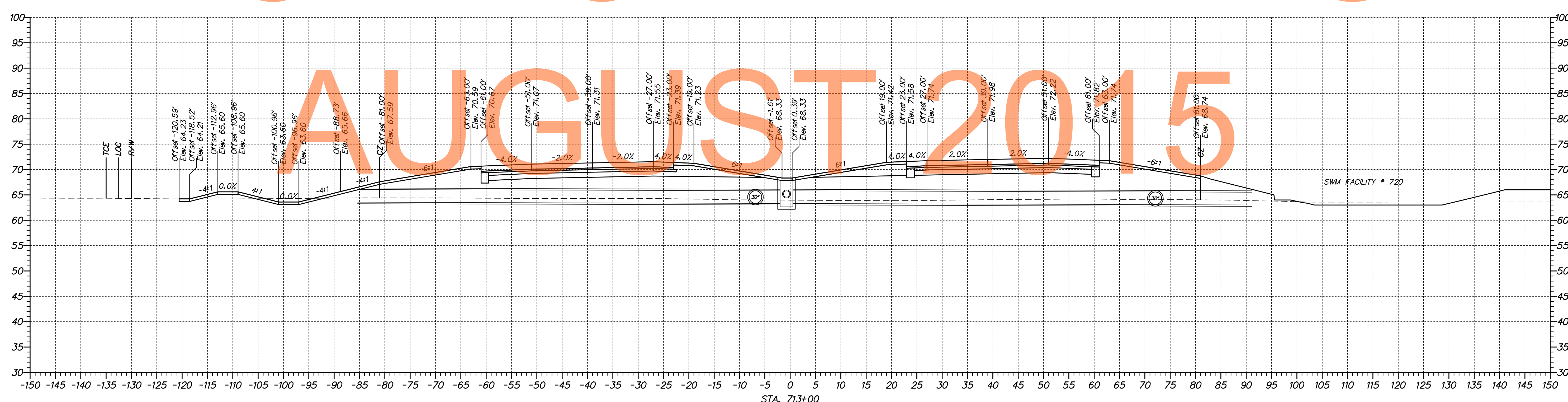
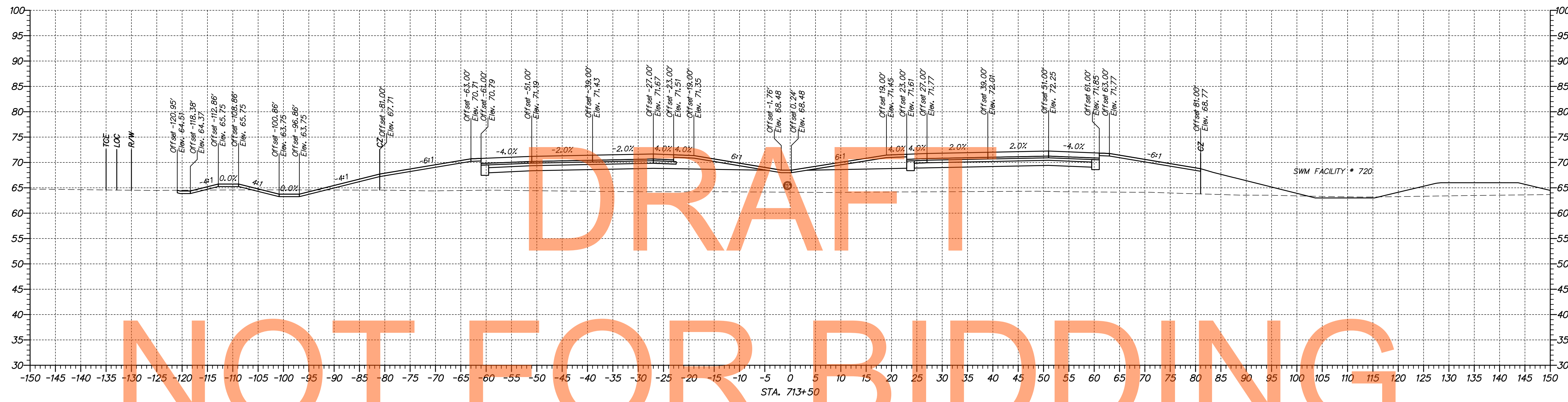

\\1653-000\sem\project\la\cadd\XS002\301_LA_70900-74850.dgn
01/30/2014 10:16:05 AM



ADDENDUMS / REVISIONS	

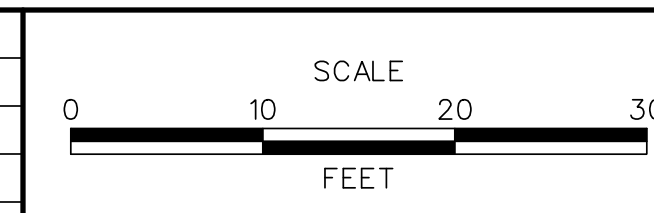

US 301,
SR 896 TO SR 1

CONTRACT T200911308	BRIDGE NO.
COUNTY NEW CASTLE	DESIGNED BY: MEF
	CHECKED BY: TAO

CROSS SECTIONS
US 301 MAINLINE

SHEET NO. 43
TOTAL SHTS. 337

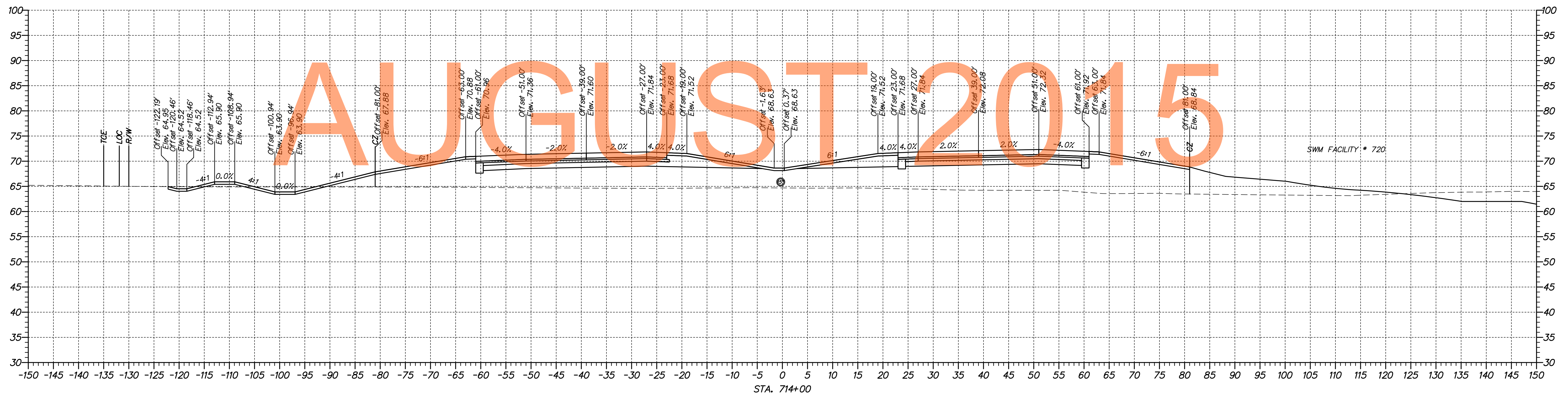
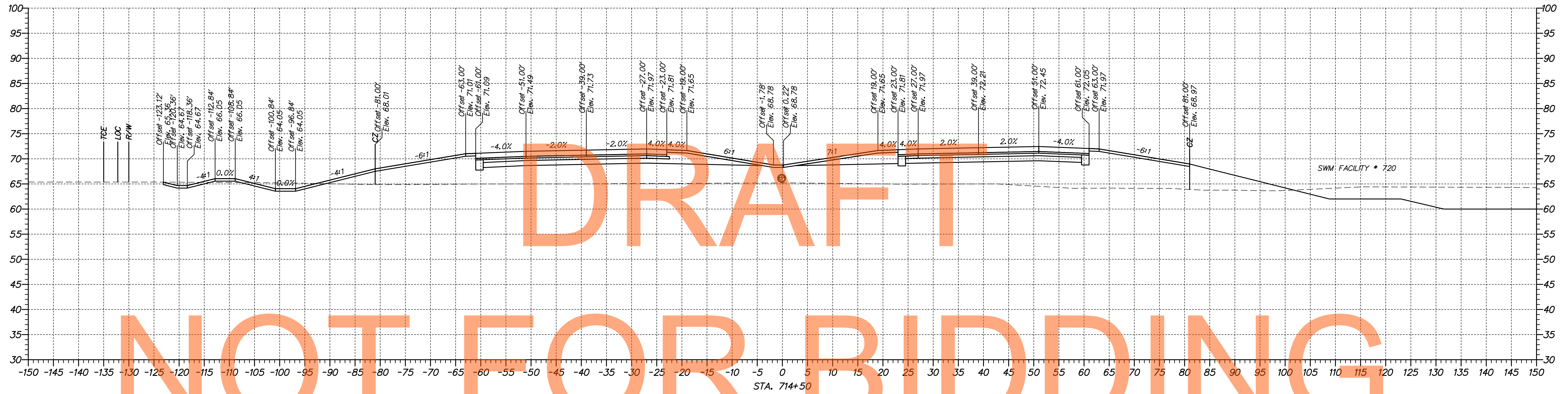

DRAFT
NOT FOR BIDDING

ADDENDUMS / REVISIONS

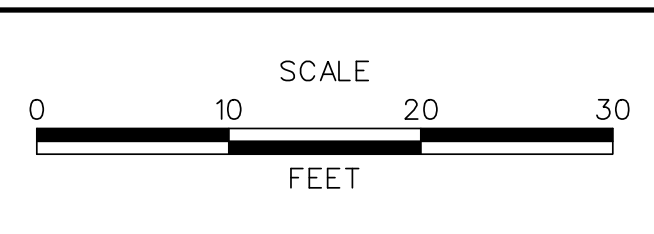

**US 301,
SR 896 TO SR 1**

CONTRACT T200911308	BRIDGE NO.
COUNTY NEW CASTLE	DESIGNED BY: MEF
	CHECKED BY: TAO

**CROSS SECTIONS
US 301 MAINLINE**

SHEET NO.	44
TOTAL SHTS.	337

p:\1653-000\sect\sect\1a\cadd\XS002\301_LA_70900-74850.dgn 09/30/2014 10:16:10 AM



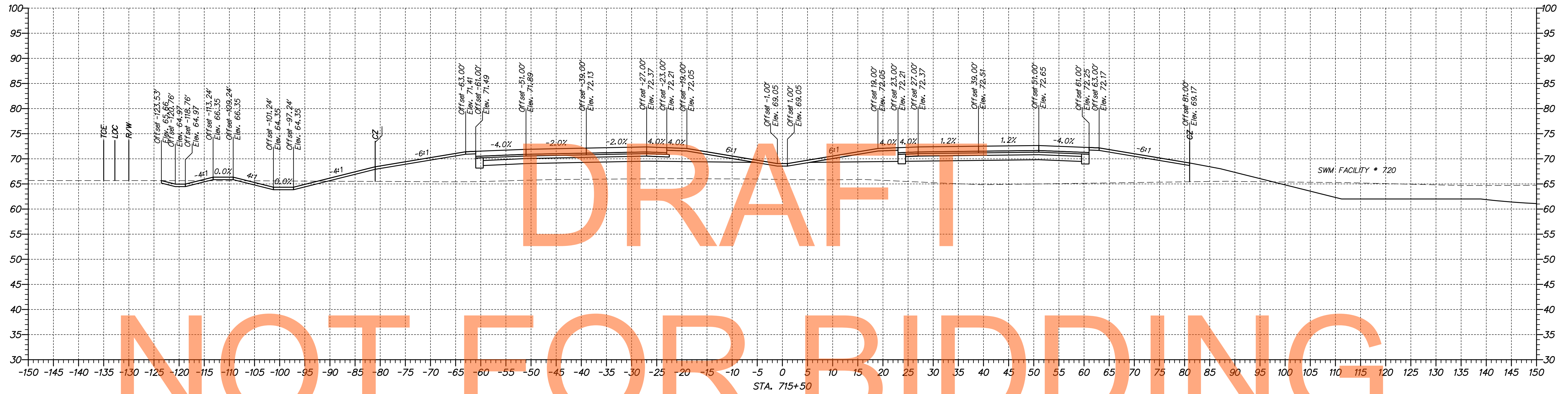

DRAFT

NOT FOR BIDDING

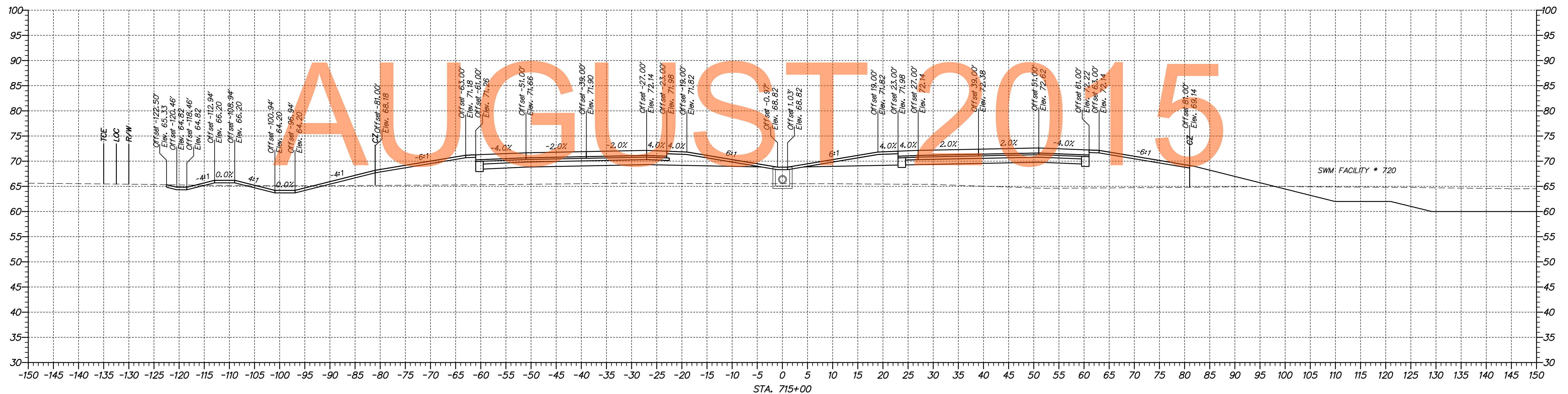

ADDENDUMS / REVISIONS	

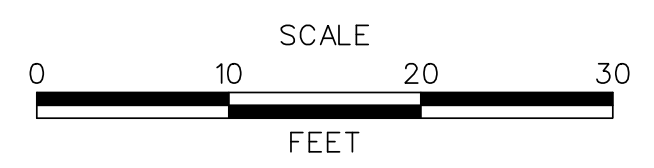

**US 301,
SR 896 TO SR 1**

CONTRACT	BRIDGE NO.
T200911308	DESIGNED BY: MEF
COUNTY	CHECKED BY: TAO
NEW CASTLE	

**CROSS SECTIONS
US 301 MAINLINE**

SHEET NO.
45
TOTAL SHTS.
337

p:\1653-000\sect\refect\la\cadd\XS002\301_LA_70900-74850.dgn
 01/30/2014 10:06:12 AM



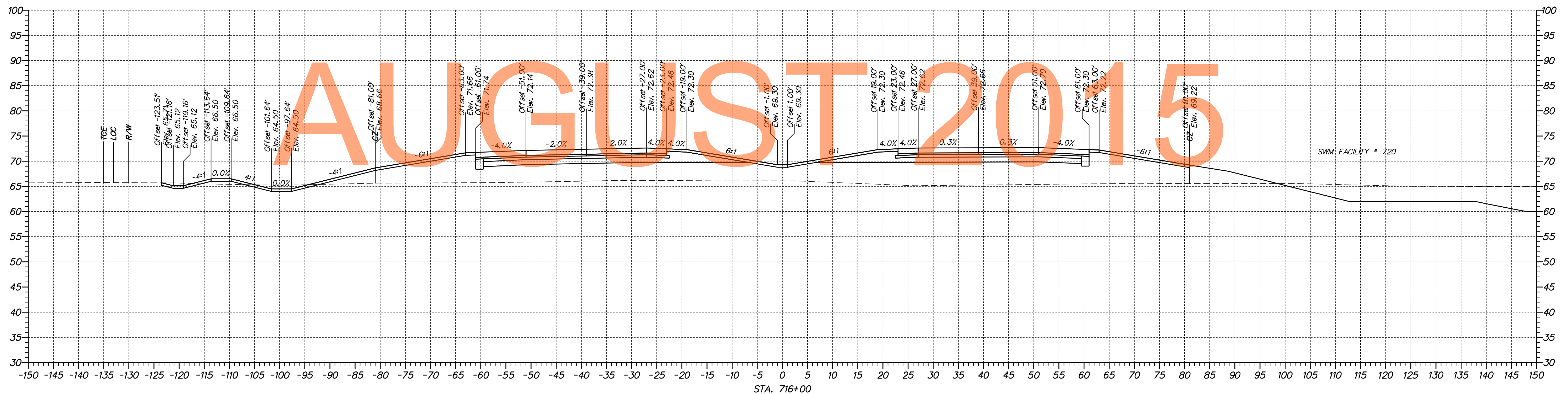
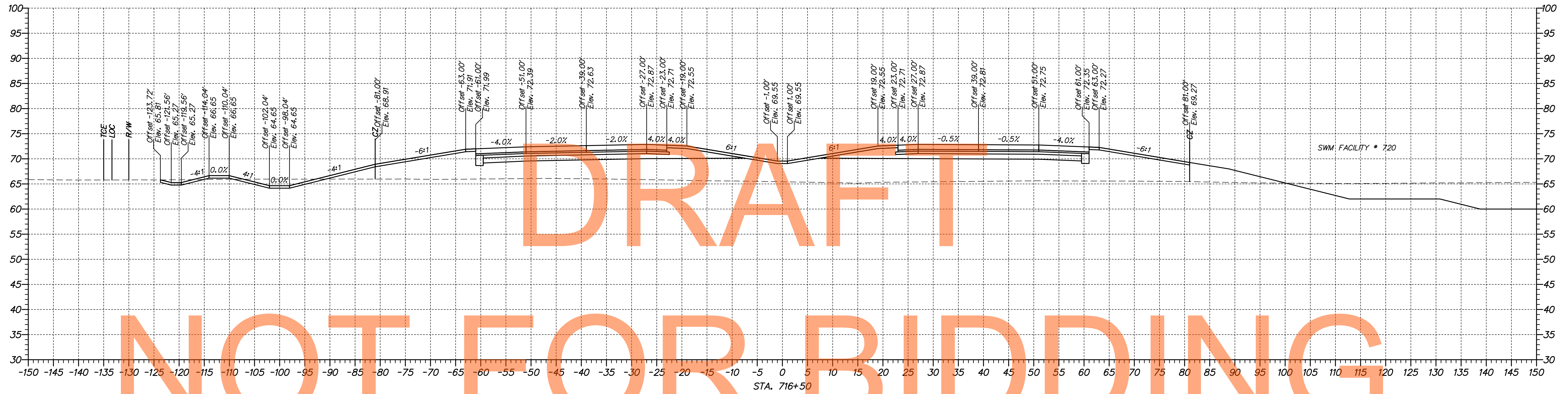

DRAFT

NOT FOR BIDDING

p:\1653-000\sect\sect\la\cead\XS002\301_LA_70900-74850.dgn
 01/30/2014 10:06:15 AM



ADDENDUMS / REVISIONS	

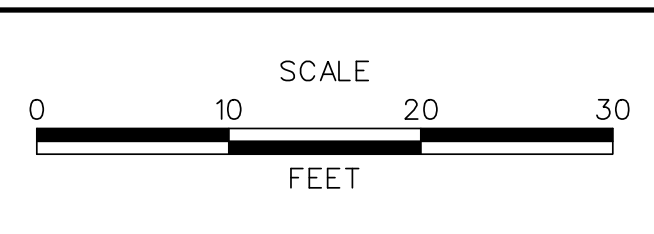

**US 301,
SR 896 TO SR 1**

CONTRACT	BRIDGE NO.
T200911308	DESIGNED BY: MEF
COUNTY	CHECKED BY: TAO
NEW CASTLE	

CROSS SECTIONS US 301 MAINLINE	SHEET NO.
	46
CROSS SECTIONS US 301 MAINLINE	TOTAL SHTS.
	337

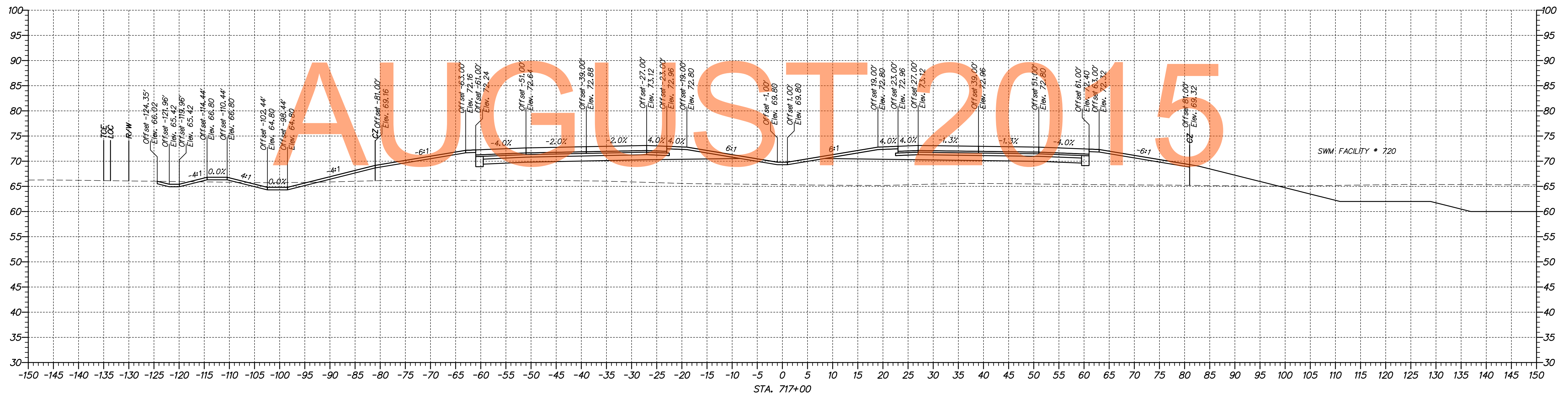
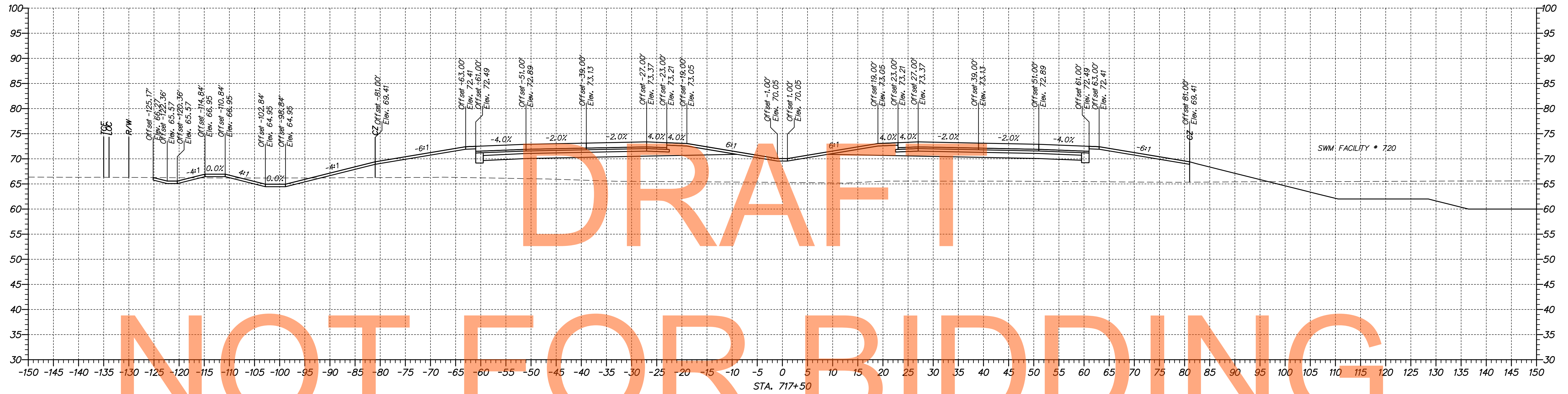

DRAFT

NOT FOR BIDDING

ADDENDUMS / REVISIONS	

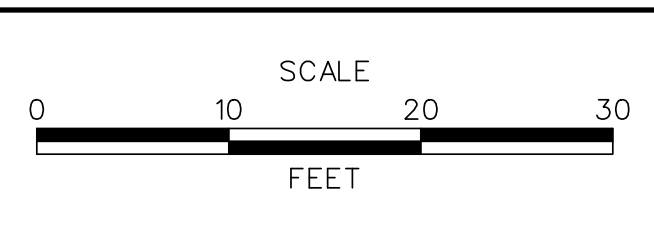

**US 301,
SR 896 TO SR 1**

CONTRACT T200911308	BRIDGE NO.
COUNTY NEW CASTLE	DESIGNED BY: MEF
	CHECKED BY: TAO

**CROSS SECTIONS
US 301 MAINLINE**

SHEET NO. 47
TOTAL SHTS. 337

p:\1653-000\external\la\cedar\XS002\301_LA_70900-74850.dgn
 09/30/2014 10:57:41 AM



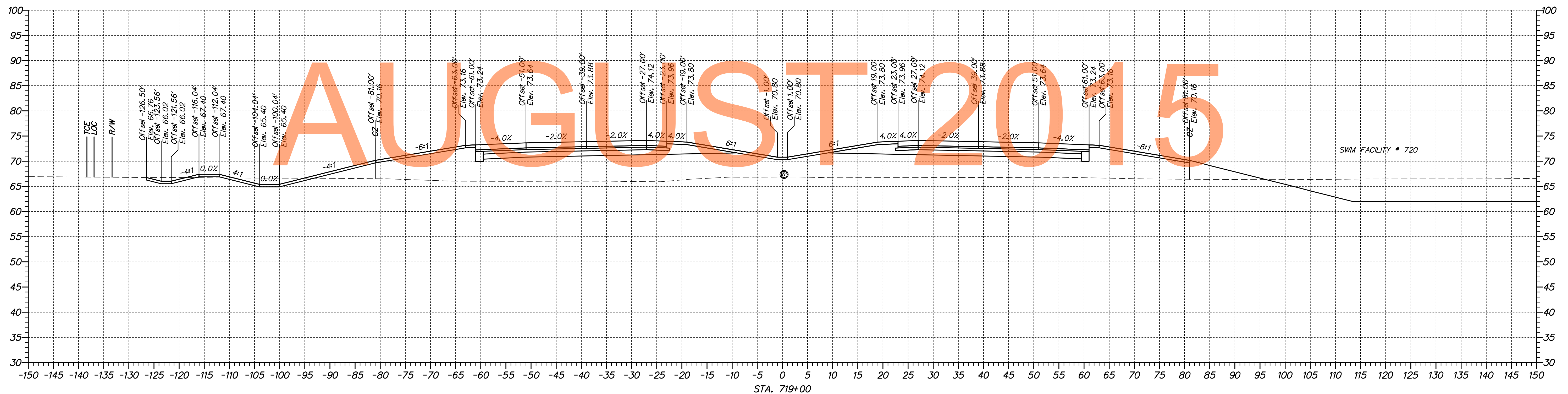
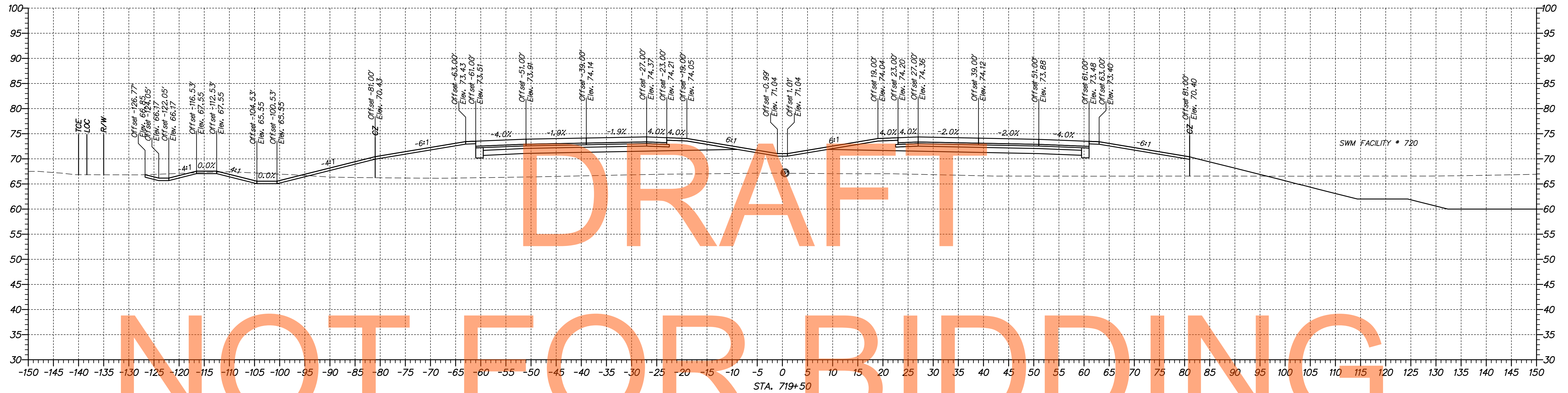

DRAFT

NOT FOR BIDDING

AUGUST 2015

p:\1653-000\semitract\la\cead\XS002\301_LA_70900-74850.dgn
 08/30/2014 10:06:22 AM

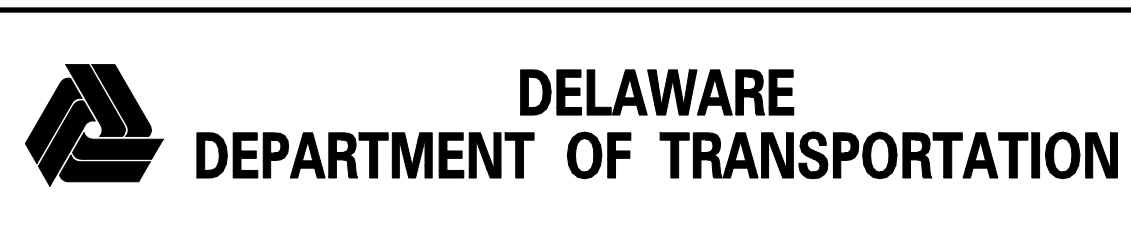

ADDENDUMS / REVISIONS	

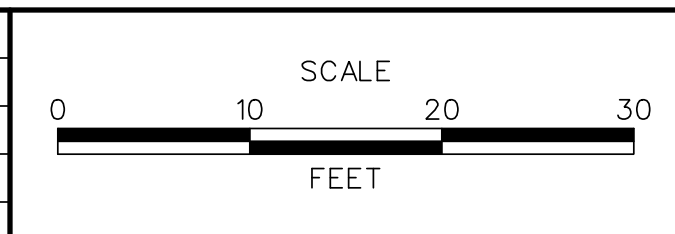

**US 301,
SR 896 TO SR 1**

CONTRACT	BRIDGE NO.
T200911308	DESIGNED BY: MEF
COUNTY	CHECKED BY: TAO
NEW CASTLE	

CROSS SECTIONS US 301 MAINLINE	SHEET NO.
	49
CROSS SECTIONS US 301 MAINLINE	TOTAL SHTS.
	337

DRAFT

NOT FOR BIDDING

AUGUST 2015

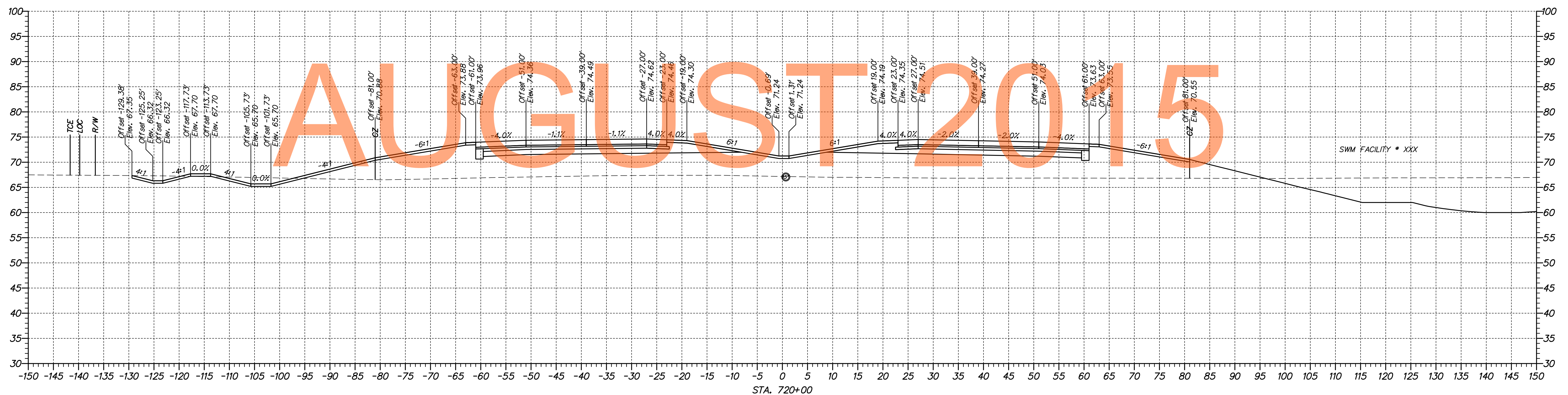
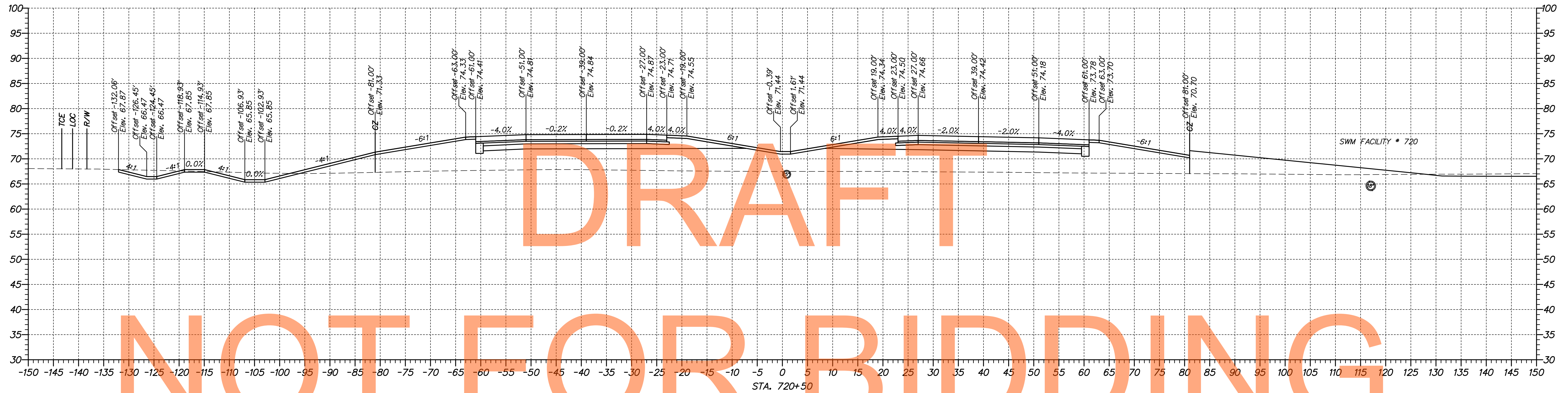

\\s01\653-000\semitruct\la\cadd\XS002\301_LA_70900-74850.dgn 09/30/2014 10:16:25 AM



ADDENDUMS / REVISIONS	

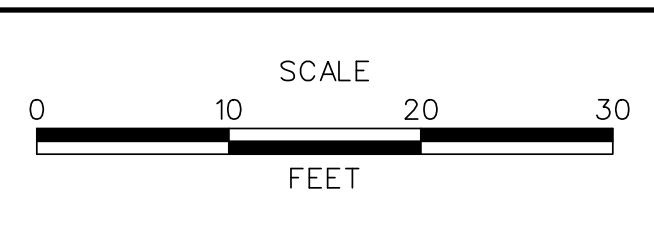

**US 301,
SR 896 TO SR 1**

CONTRACT T200911308	BRIDGE NO.
COUNTY NEW CASTLE	DESIGNED BY: MEF
	CHECKED BY: TAO

**CROSS SECTIONS
US 301 MAINLINE**

SHEET NO. 50
TOTAL SHTS. 337