

DRAFT

NOT FOR BIDDING

AUGUST 2015

No. 31653-000, CONTRACT
 8/2/2015 10:34:53 AM
 I:\CAD\X500U301_Mainline_1A.dgn



ADDENDUMS / REVISIONS

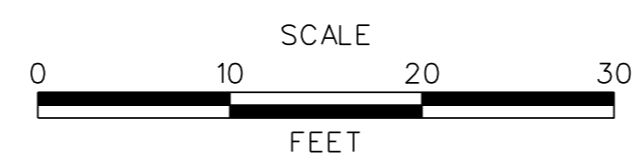

US 301,
SR 896 TO SR 1

CONTRACT	T200911308	BRIDGE NO.	
COUNTY	NEW CASTLE	DESIGNED BY:	JAD
		CHECKED BY:	BRT

CROSS SECTIONS
US 301 MAINLINE

SHEET NO.	151
TOTAL SHTS.	337

DRAFT

NOT FOR BIDDING
AUGUST 2015

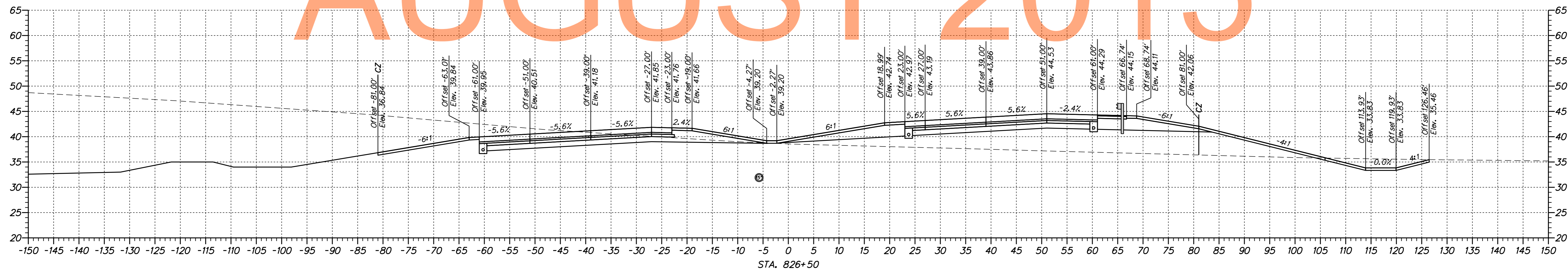
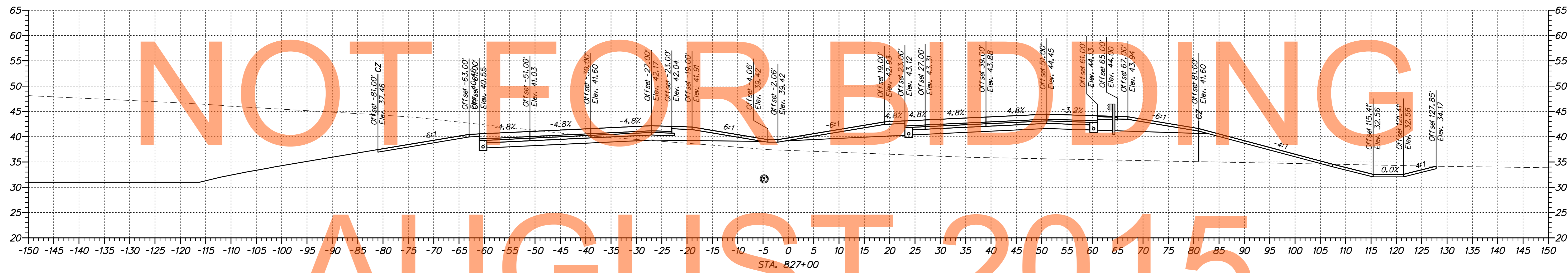
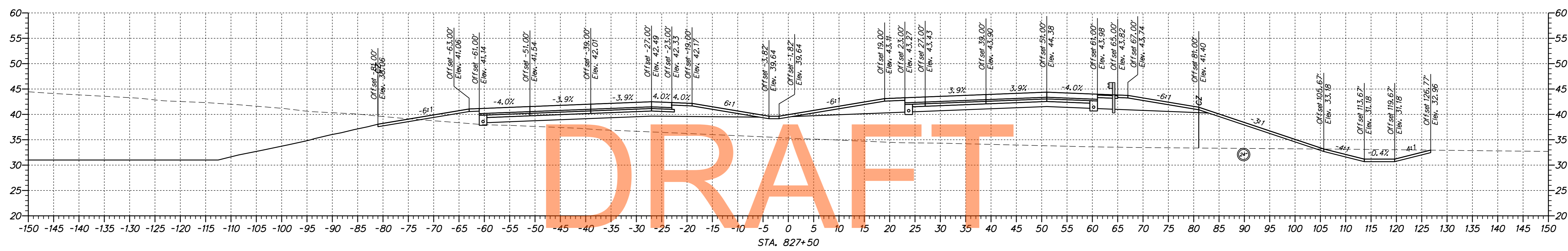

\\s1653\000\CONTRACT\14\CADD\X500U301_Marline_1A.dgn 8/2/2015 10:34:53 AM



ADDENDUMS / REVISIONS	

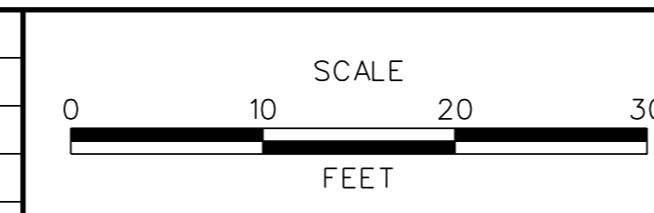

US 301,
SR 896 TO SR 1

CONTRACT	T200911308	BRIDGE NO.	
COUNTY	NEW CASTLE	DESIGNED BY:	JAD
		CHECKED BY:	BRT

CROSS SECTIONS US 301 MAINLINE	
SHEET NO.	152
TOTAL SHTS.	337

DRAFT

NOT FOR BIDDING

AUGUST 2015

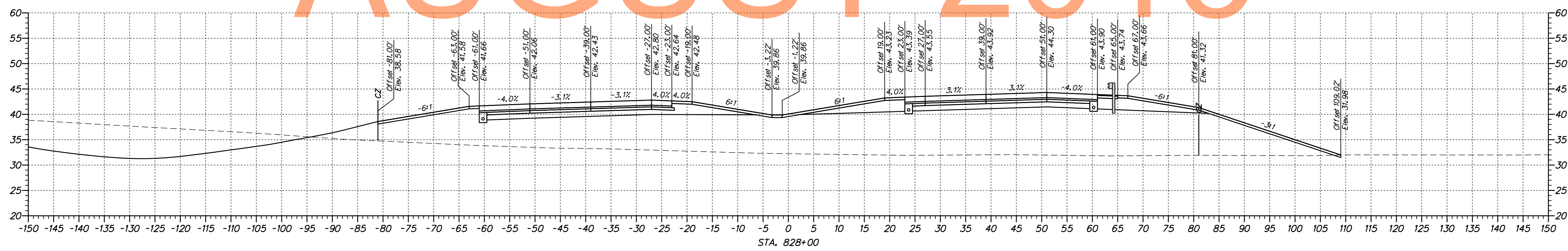
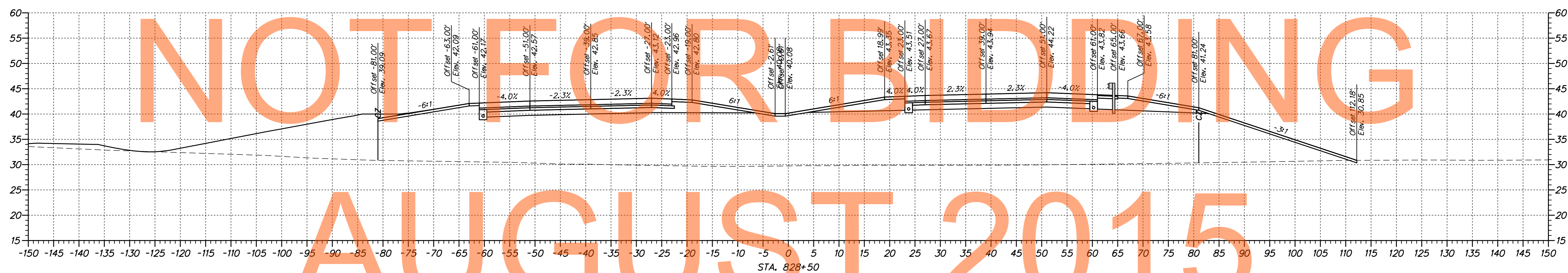
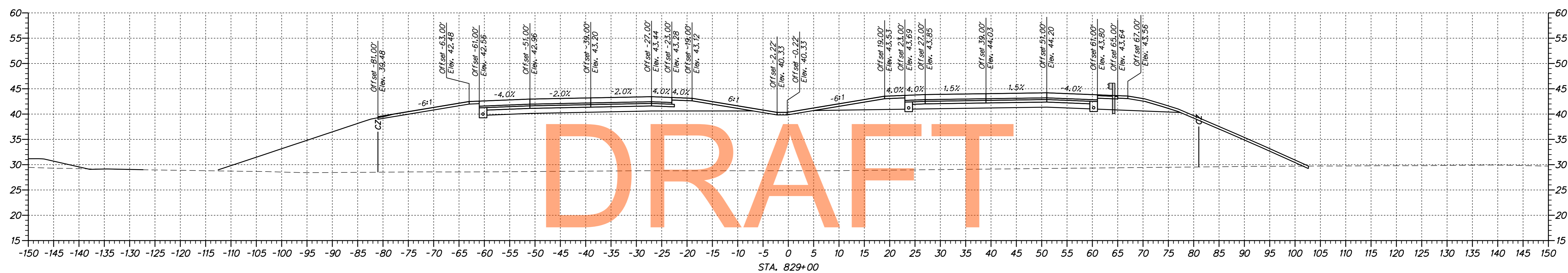

\\s31653\000\CONTRACT 10\2015\10\24\15\1A.dgn



ADDENDUMS / REVISIONS	

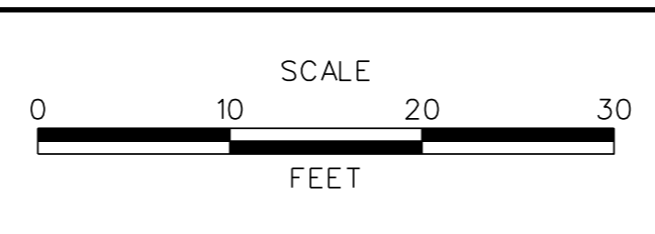

US 301,
SR 896 TO SR 1

CONTRACT	BRIDGE NO.
T200911308	DESIGNED BY: JAD
COUNTY	CHECKED BY: BRT
NEW CASTLE	

CROSS SECTIONS US 301 MAINLINE	SHEET NO.
	153
	TOTAL SHTS.
	337

DRAFT

NOT FOR BIDDING

AUGUST 2015

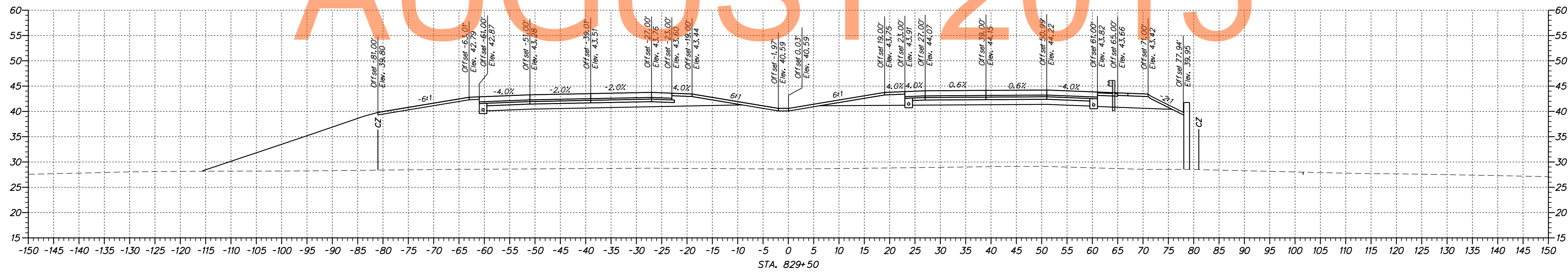
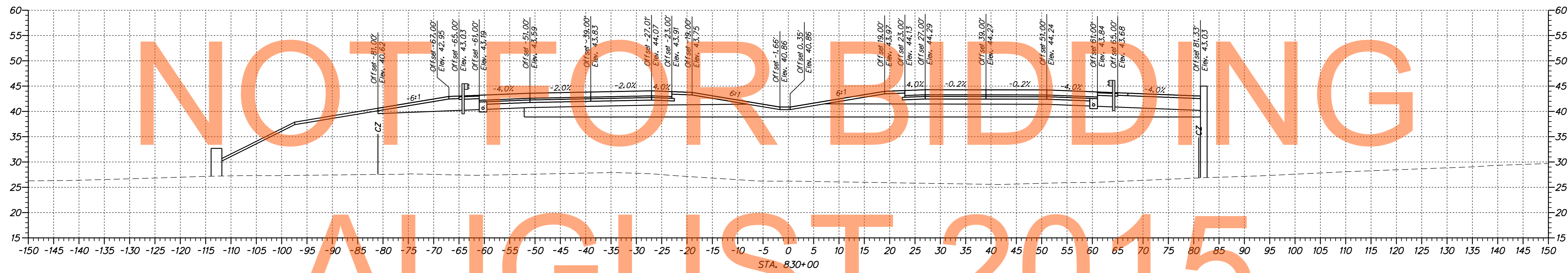
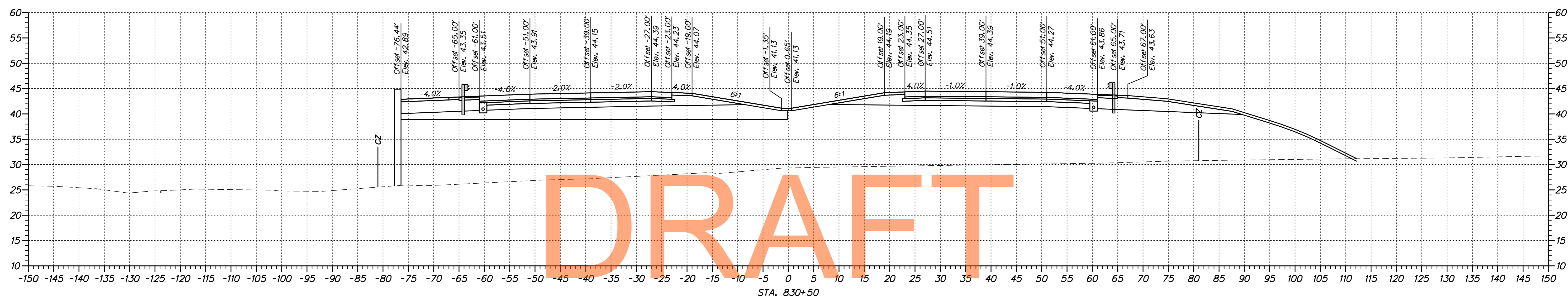

\\CAD\X50001301_Markline_1A.dgn 8/2/2015 10:24:53 AM



ADDENDUMS / REVISIONS	

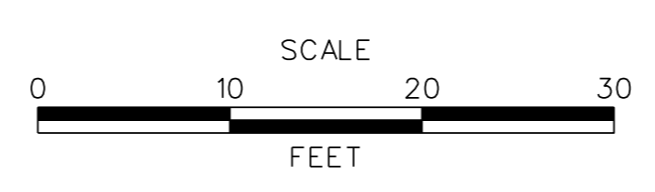

US 301, SR 896 TO SR 1

CONTRACT	T200911308	BRIDGE NO.	
COUNTY	NEW CASTLE	DESIGNED BY:	JAD
		CHECKED BY:	BRT

CROSS SECTIONS US 301 MAINLINE

SHEET NO.	154
TOTAL SHTS.	337

DRAFT

NOT FOR BIDDING
AUGUST 2015

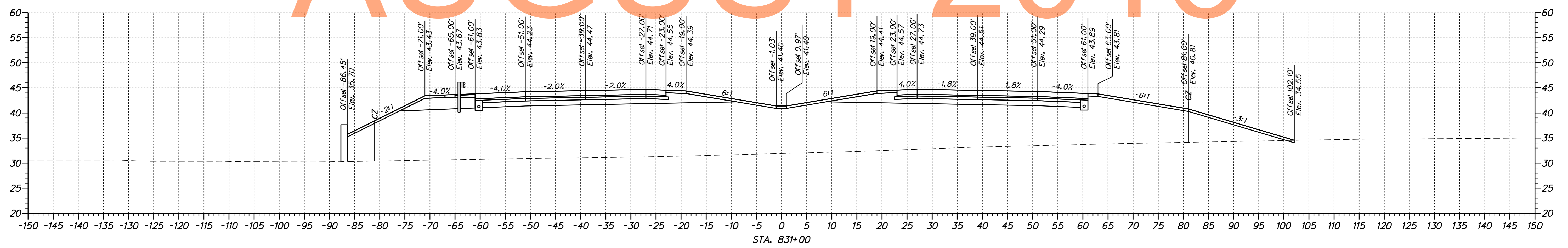
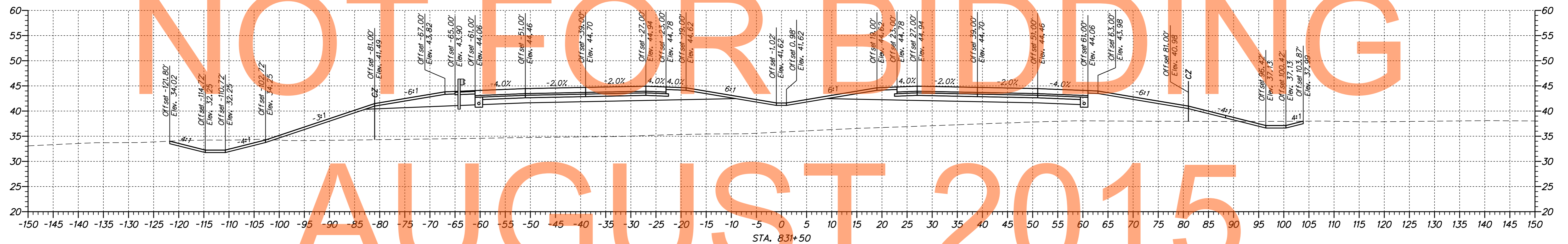
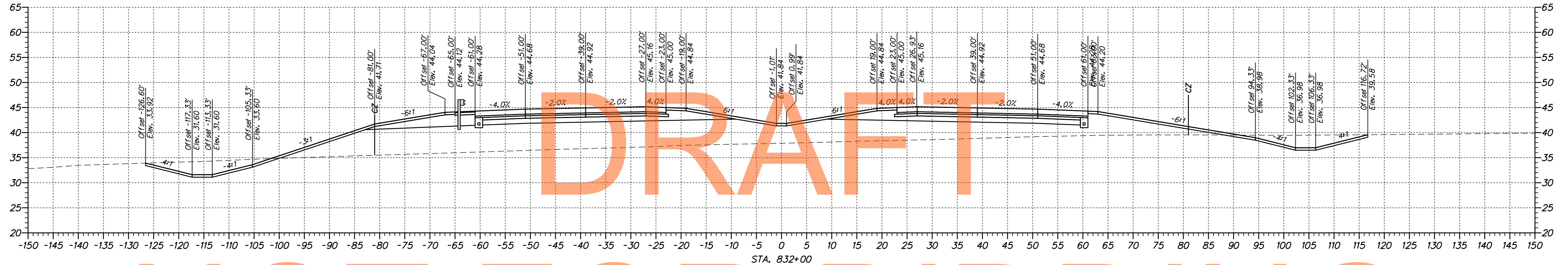

\\s31653\000\CONTRACT 14\CADD\X500U301_Mainline_1A.dgn 8/2/2015 10:24:31 AM



ADDENDUMS / REVISIONS	

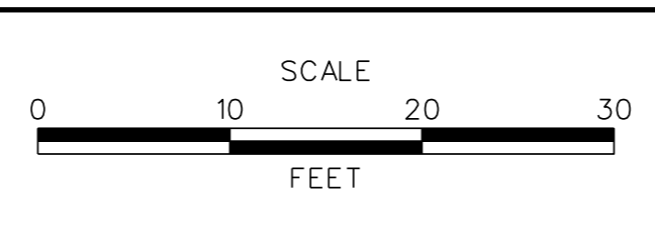

US 301,
SR 896 TO SR 1

CONTRACT T200911308	BRIDGE NO.
COUNTY NEW CASTLE	DESIGNED BY: JAD
	CHECKED BY: BRT

CROSS SECTIONS US 301 MAINLINE	SHEET NO. 155
	TOTAL SHTS. 337

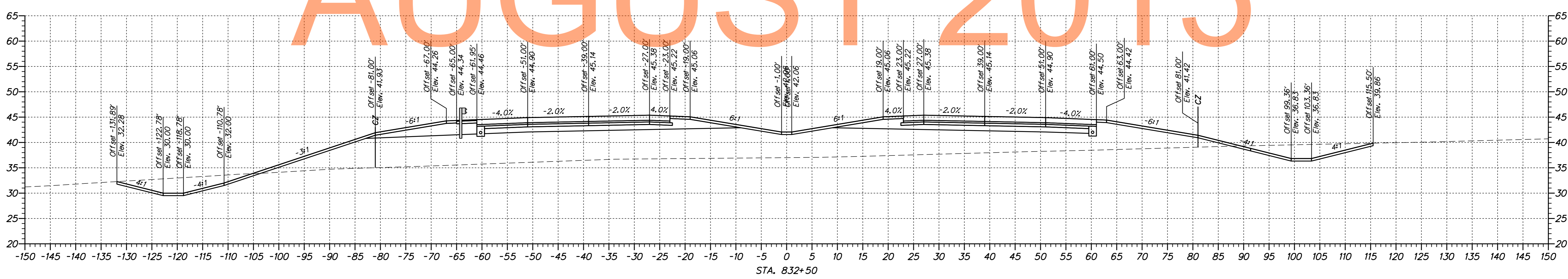
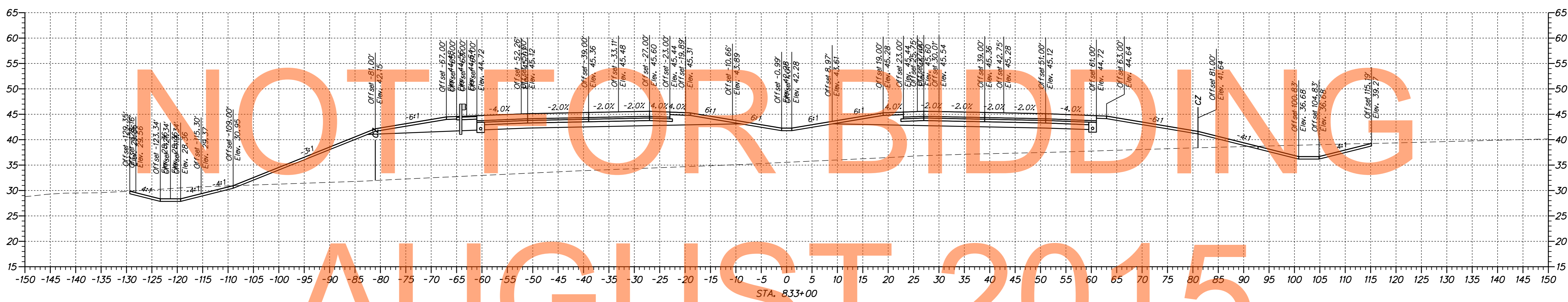
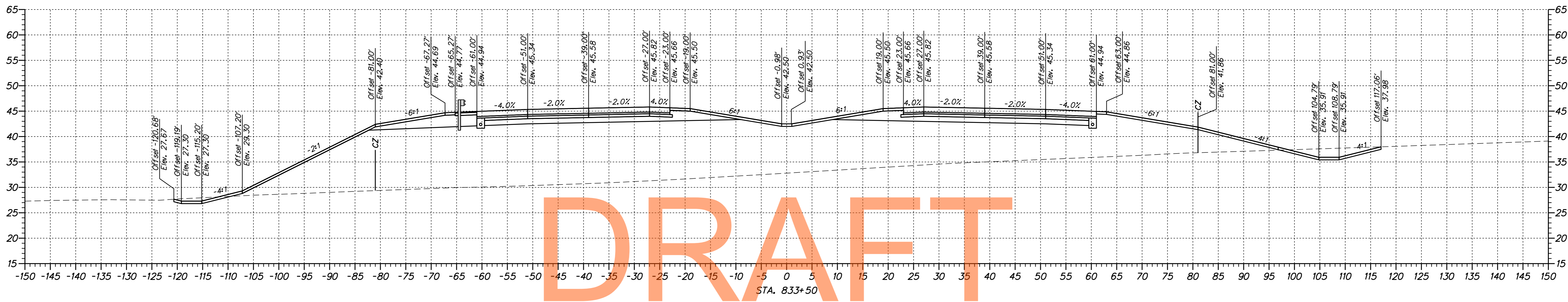

DRAFT

NOT FOR BIDDING

AUGUST 2015

No. 31653-000, CONTRACT 1A-CADD, XS000U301_M, Mainline_1A.dgn
 8/2/2015 10:24:31 AM



ADDENDUMS / REVISIONS	

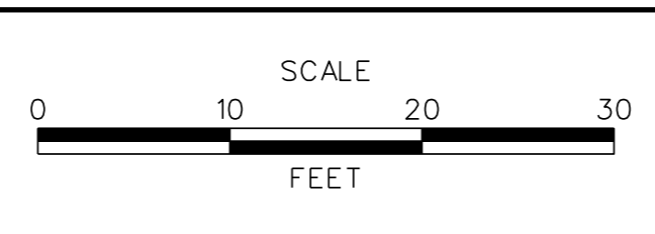

**US 301,
SR 896 TO SR 1**

CONTRACT	T200911308	BRIDGE NO.	
COUNTY	NEW CASTLE	DESIGNED BY:	JAD
		CHECKED BY:	BRT

CROSS SECTIONS US 301 MAINLINE	
SHEET NO.	156
TOTAL SHTS.	337

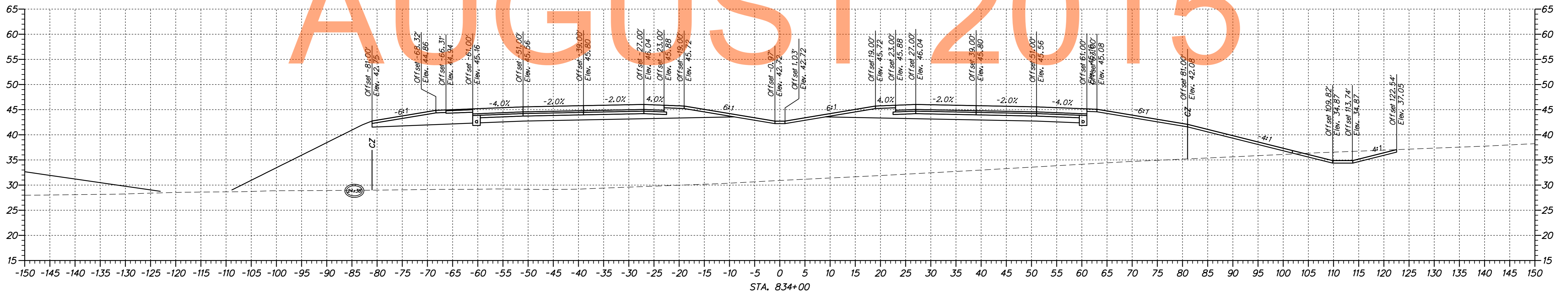
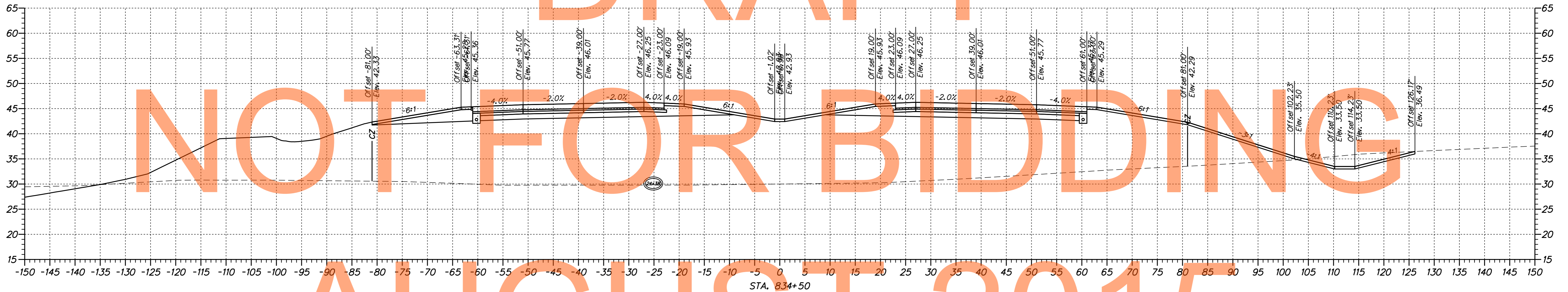
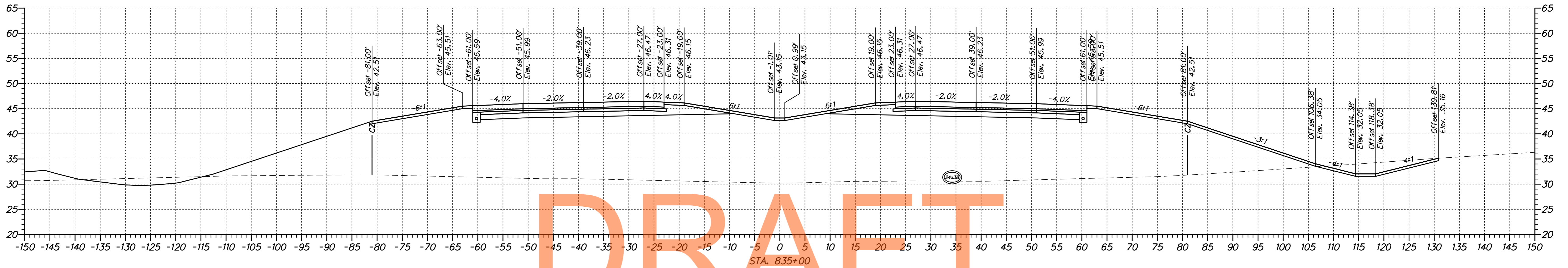

M:\31653\000\CONTRACT\14\CADD\X500U101_Marline_1A.dgn
 8/2/2015 10:24:31 AM



ADDENDUMS / REVISIONS	

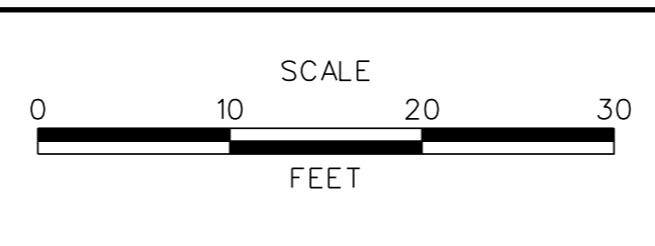

US 301,
 SR 896 TO SR 1

CONTRACT	BRIDGE NO.
T200911308	DESIGNED BY: JAD
COUNTY	CHECKED BY: BRT
NEW CASTLE	

CROSS SECTIONS US 301 MAINLINE	
SHEET NO.	157
TOTAL SHTS.	337

DRAFT

NOT FOR BIDDING

AUGUST 2015

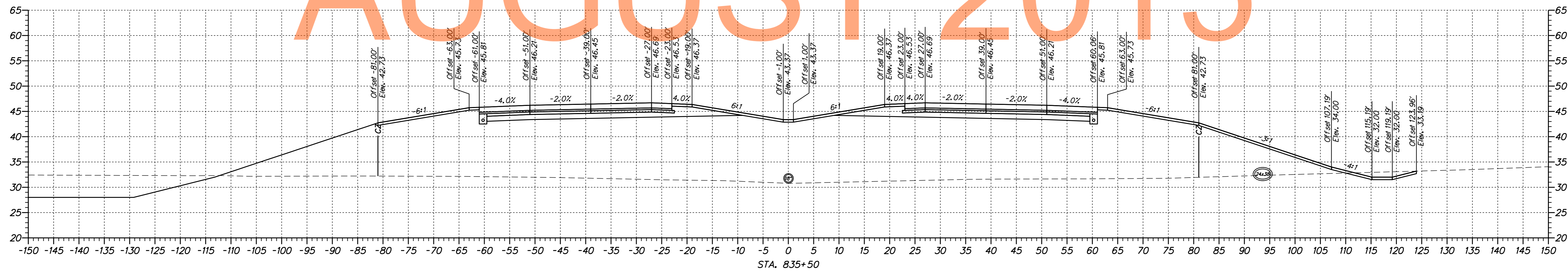
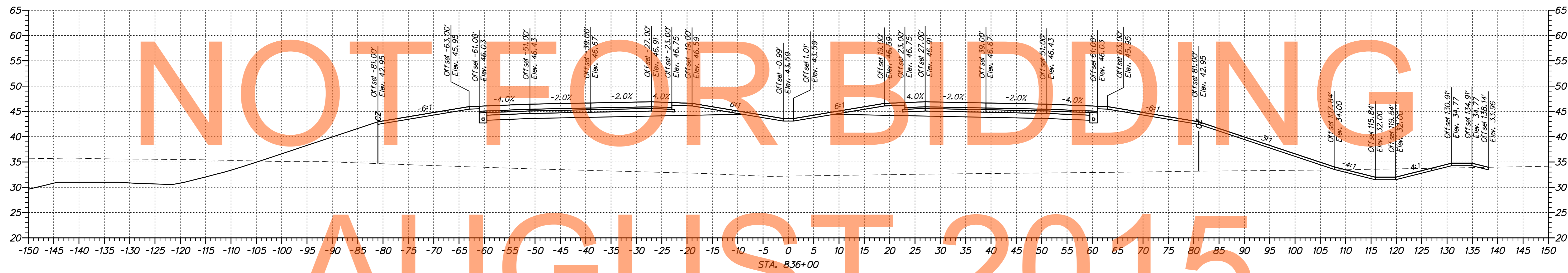
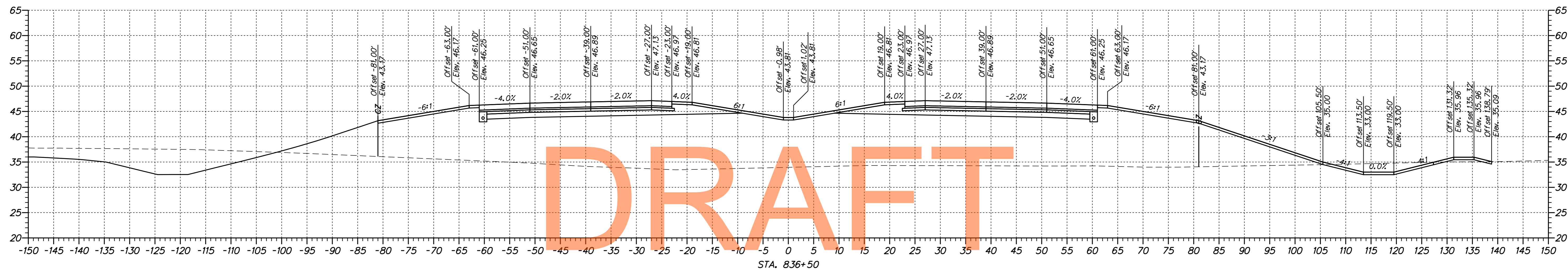

\\NAS1653\000\CONTRACT\14\CADD\X500U101_Marline_1A.dgn 9/2/2015 10:24:31 AM



ADDENDUMS / REVISIONS	

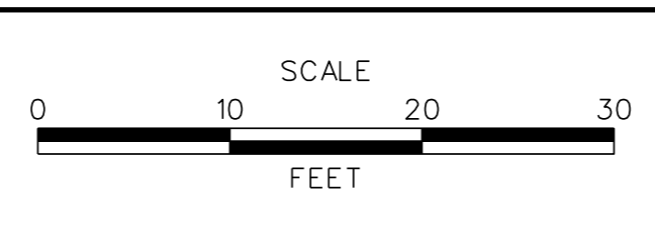

US 301,
SR 896 TO SR 1

CONTRACT T200911308	BRIDGE NO.
COUNTY NEW CASTLE	DESIGNED BY: JAD
	CHECKED BY: BRT

CROSS SECTIONS US 301 MAINLINE	SHEET NO. 158
	TOTAL SHTS. 337

DRAFT

NOT FOR BIDDING

AUGUST 2015

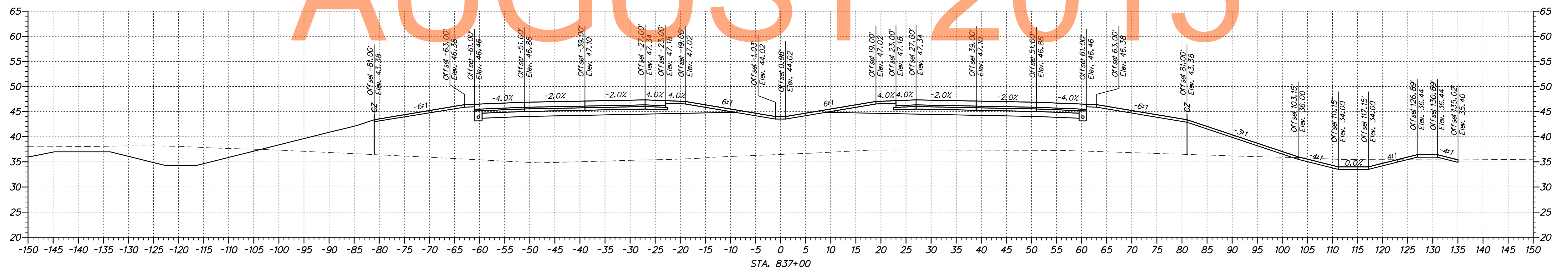
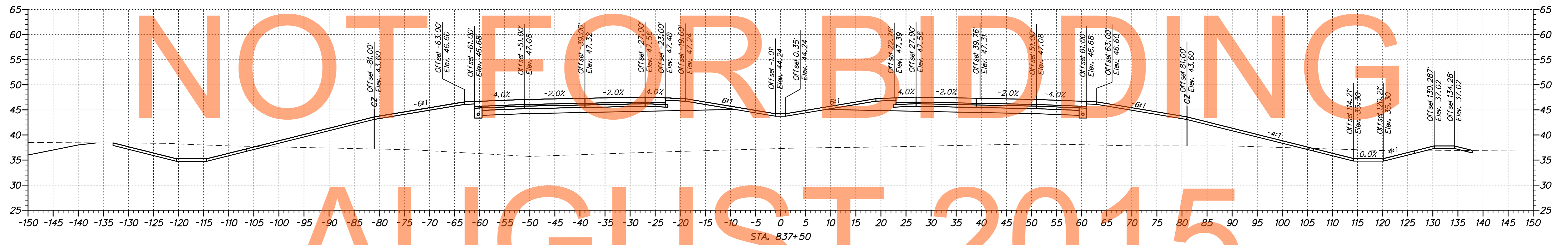

M:\31653\000\CONTRACT\1A\CADD\X500U301_Marline_1A.dgn
 8/2/2015 10:24:51 AM



ADDENDUMS / REVISIONS	

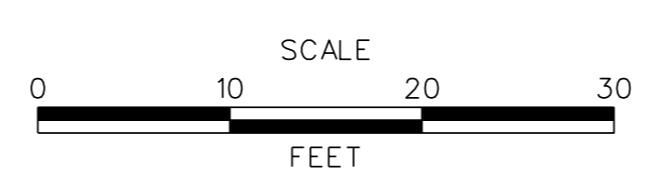

US 301,
SR 896 TO SR 1

CONTRACT	BRIDGE NO.
T200911308	DESIGNED BY: JAD
COUNTY	CHECKED BY: BRT
NEW CASTLE	

CROSS SECTIONS
US 301 MAINLINE

SHEET NO.
159
TOTAL SHTS.
337

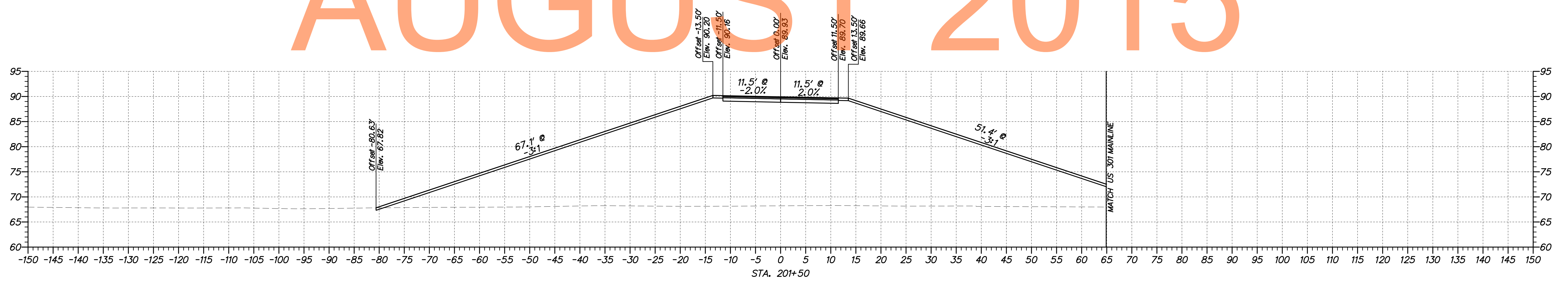
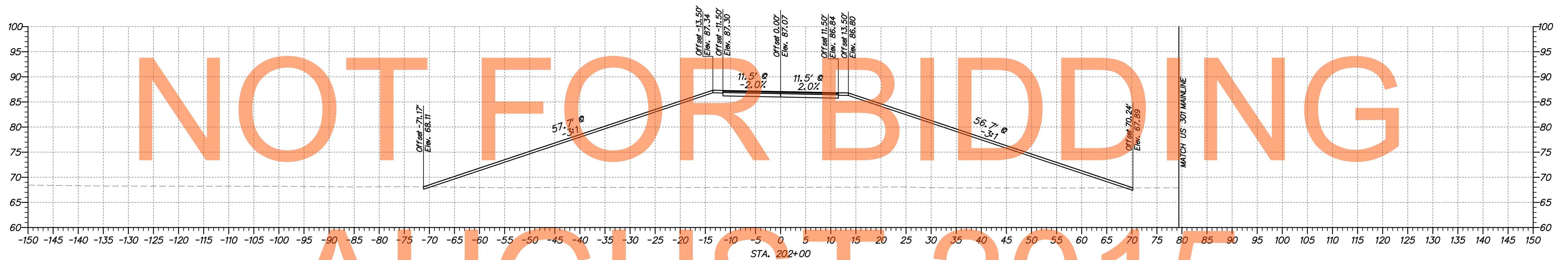
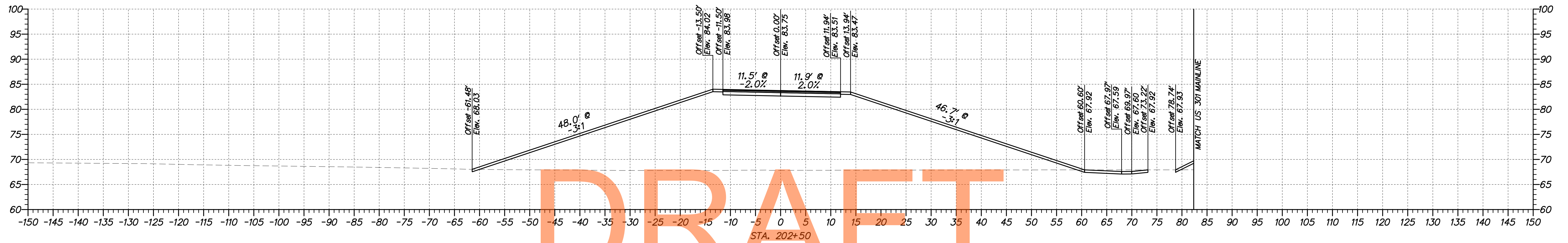

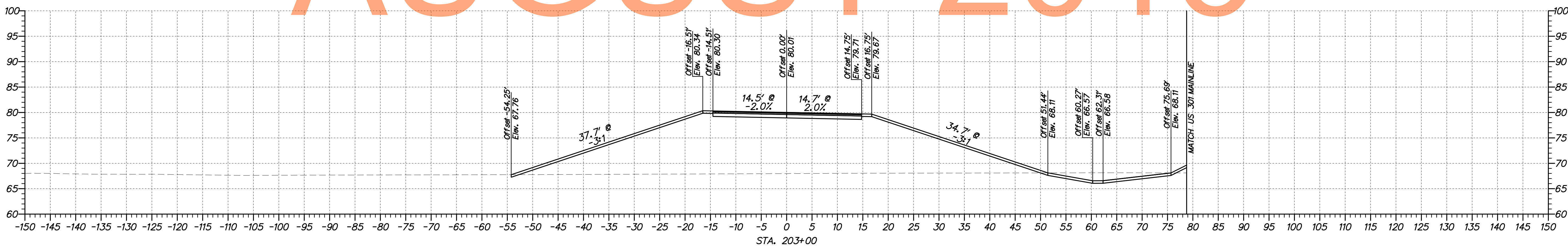
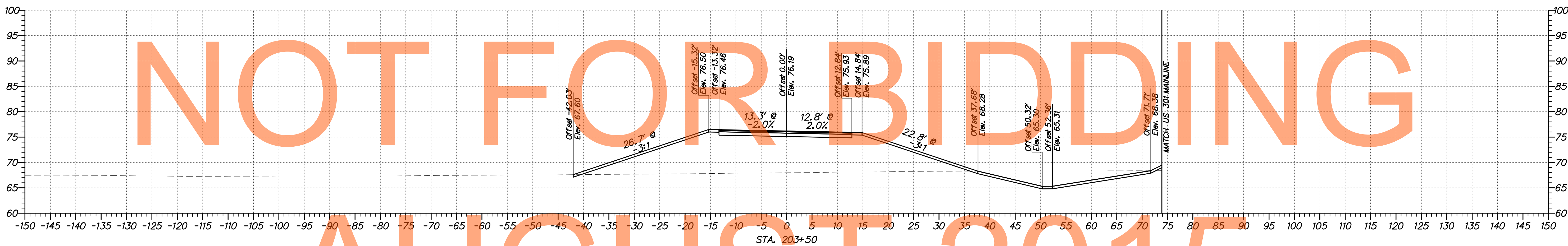
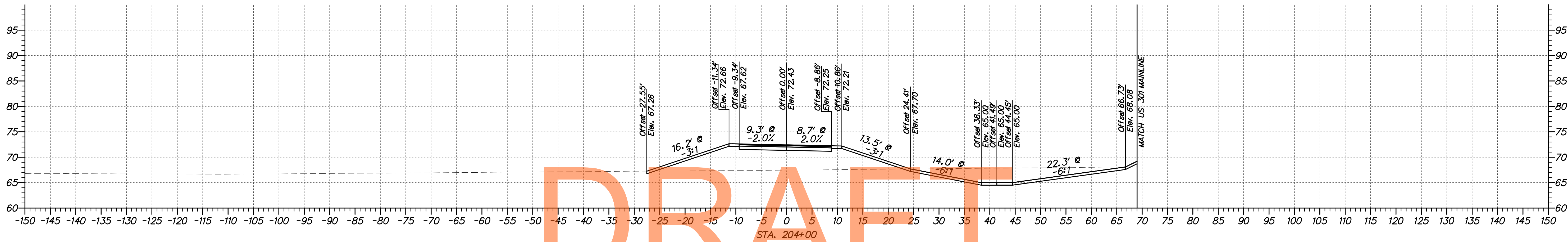

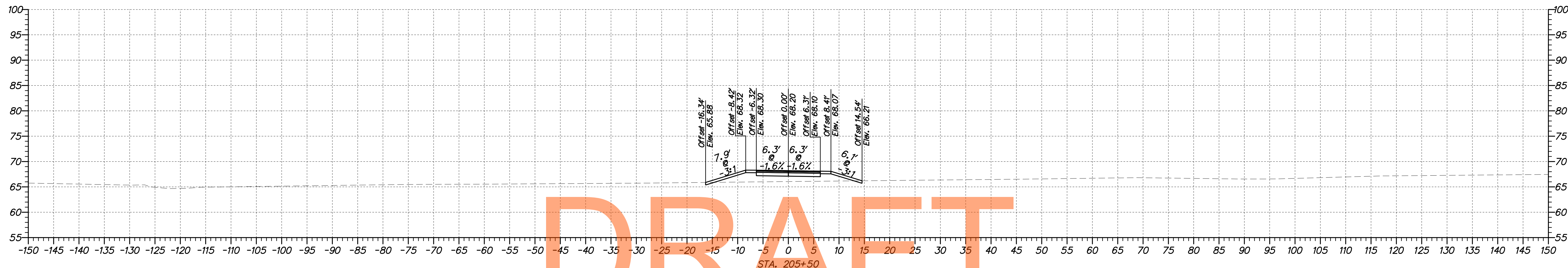

DRAFT

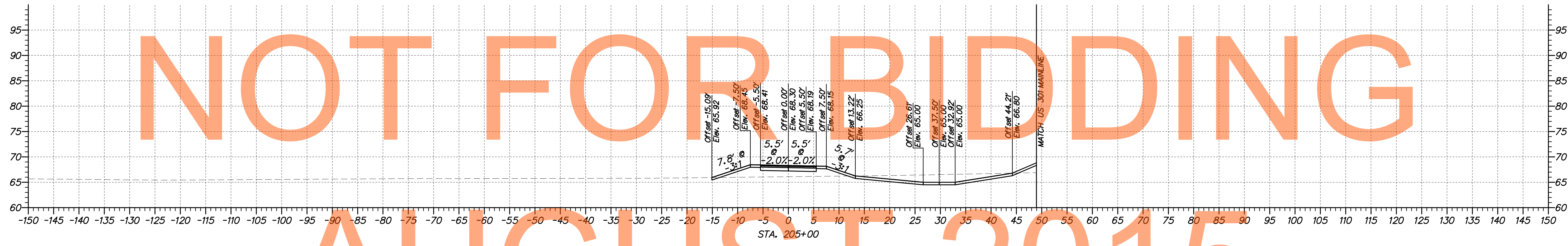

AUGUST 2015

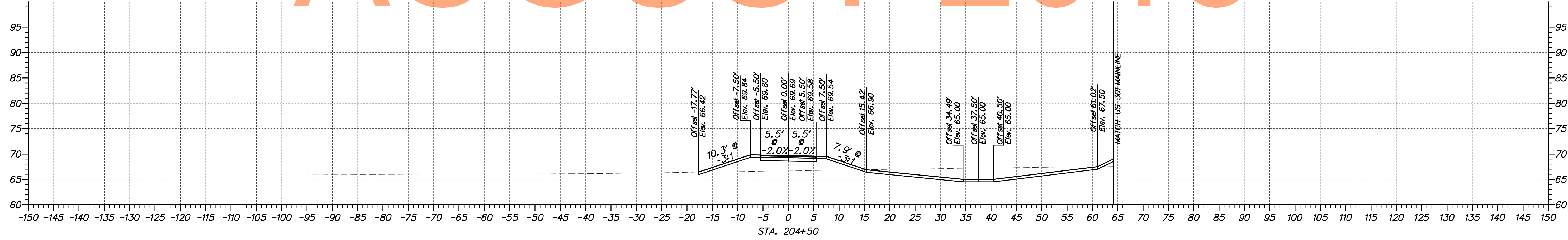

ADDENDUMS / REVISIONS	

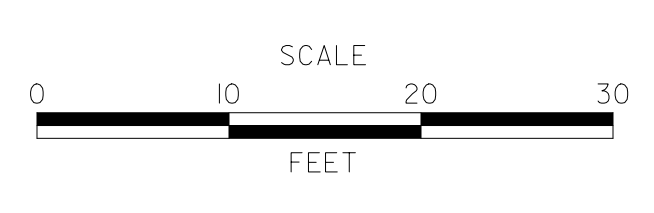

**US 301,
SR 896 TO SR 1**

CONTRACT T200911308	BRIDGE NO.
COUNTY NEW CASTLE	DESIGNED BY: WJD
	CHECKED BY: MAA

**CROSS SECTIONS
SB EMERGENCY RAMP
STA. 204+50 TO STA. 205+50**

SHEET NO. 162
TOTAL SHTS. 337

DRAFT

NOT FOR BIDDING

AUGUST 2015

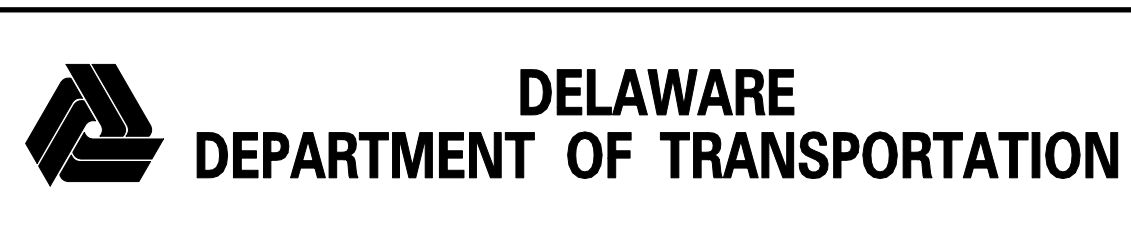
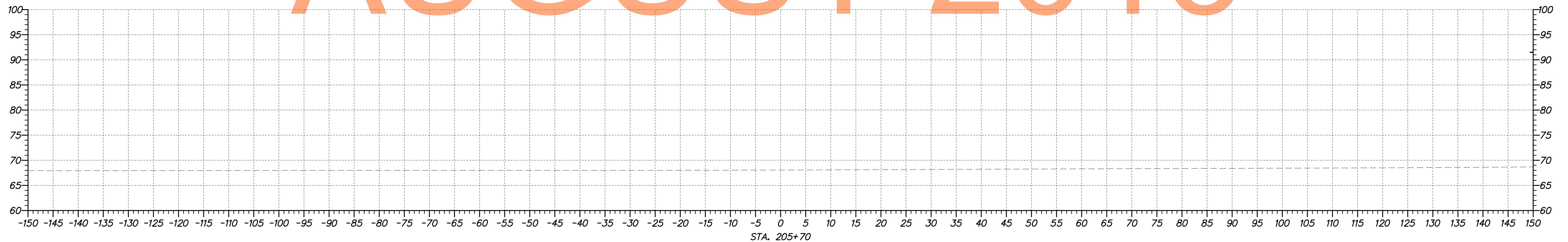

ADDENDUMS / REVISIONS



**US 301,
SR 896 TO SR 1**

CONTRACT T200911308	BRIDGE NO.
COUNTY NEW CASTLE	DESIGNED BY: WJD CHECKED BY: MAA

**CROSS SECTIONS
SB EMERGENCY RAMP**
STA. 205+70 TO STA. 205+70

SHEET NO.	163
TOTAL SHTS.	337

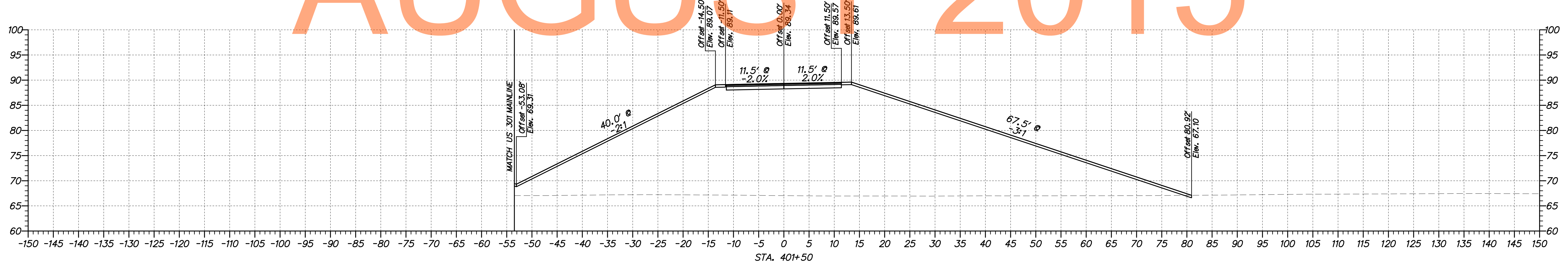
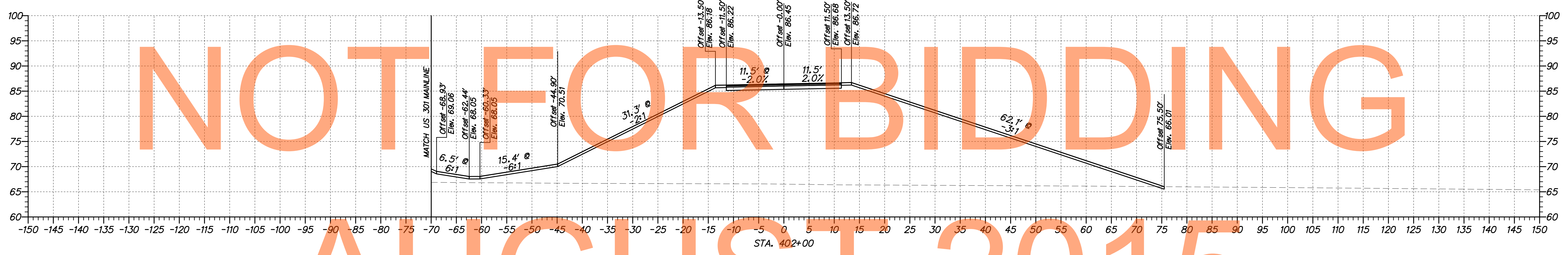
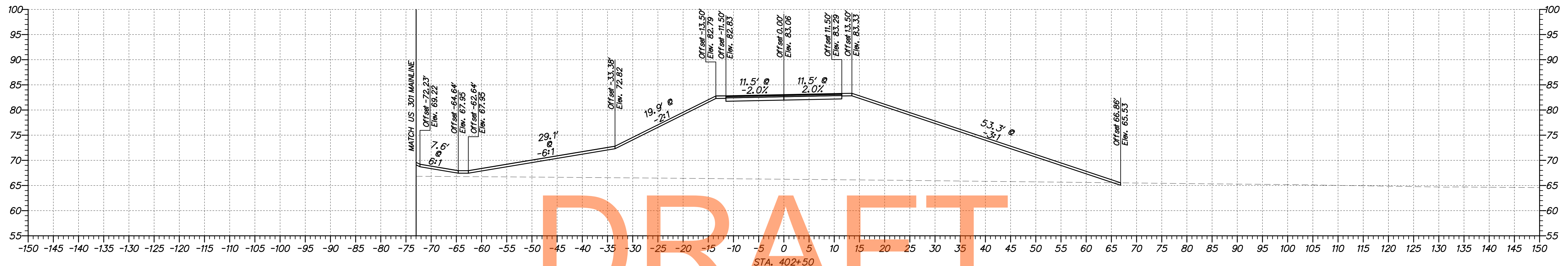

DRAFT

NOT FOR BIDDING

AUGUST 2015

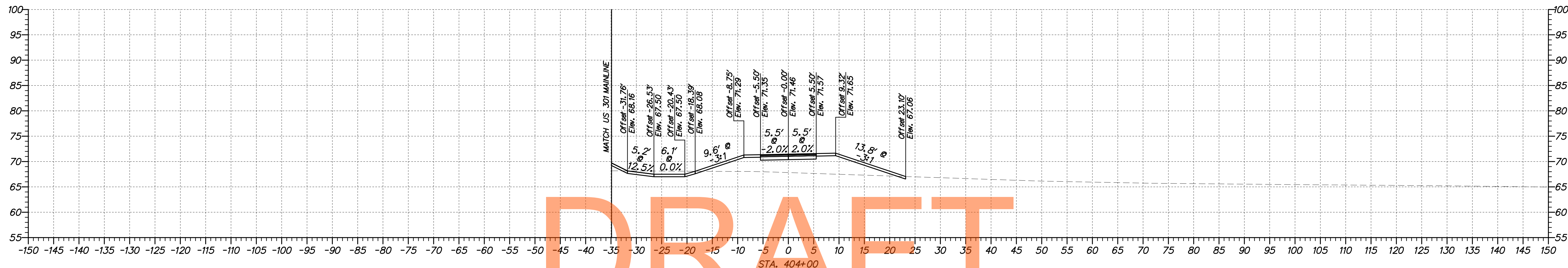

DRAFT

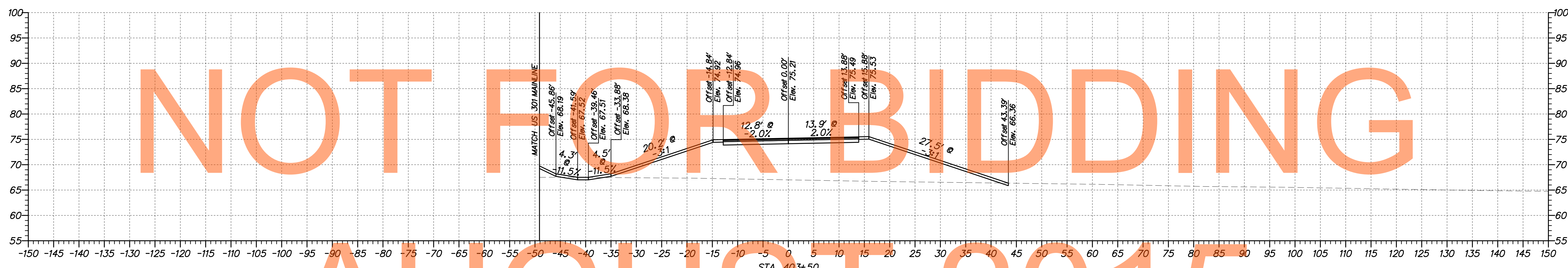

NOT FOR BIDDING

AUGUST 2015

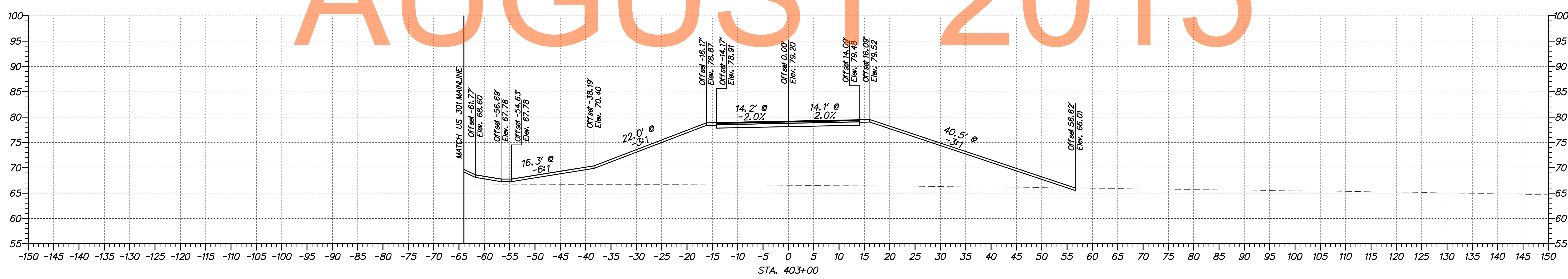

ADDENDUMS / REVISIONS	

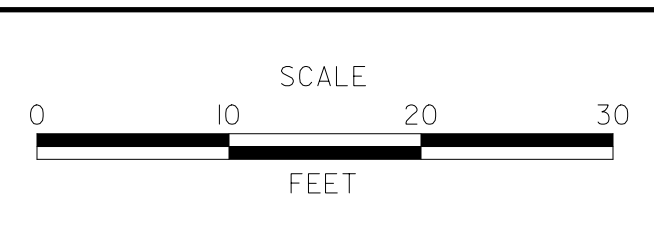

**US 301,
SR 896 TO SR 1**

CONTRACT T200911308	BRIDGE NO.
COUNTY NEW CASTLE	DESIGNED BY: WJD
	CHECKED BY: MAA

**CROSS SECTIONS
NB EMERGENCY RAMP
STA. 403+00 TO STA. 404+00**

SHEET NO. 165
TOTAL SHTS. 337

DRAFT

NOT FOR BIDDING

AUGUST 2015

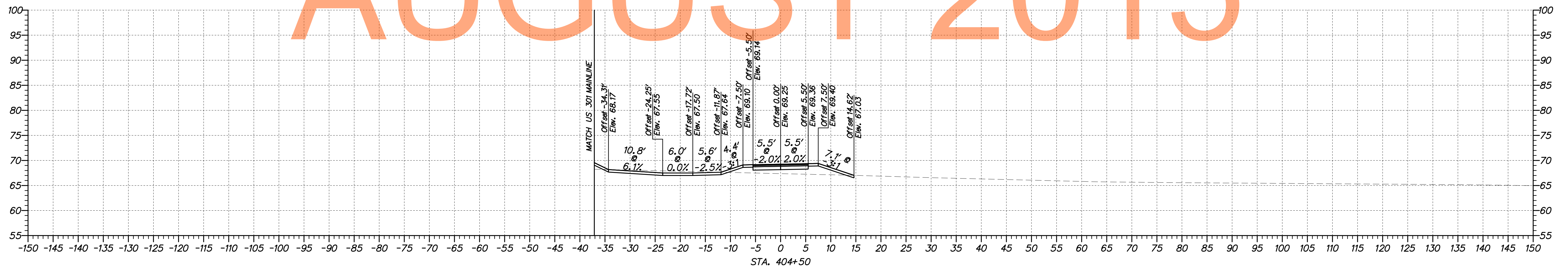
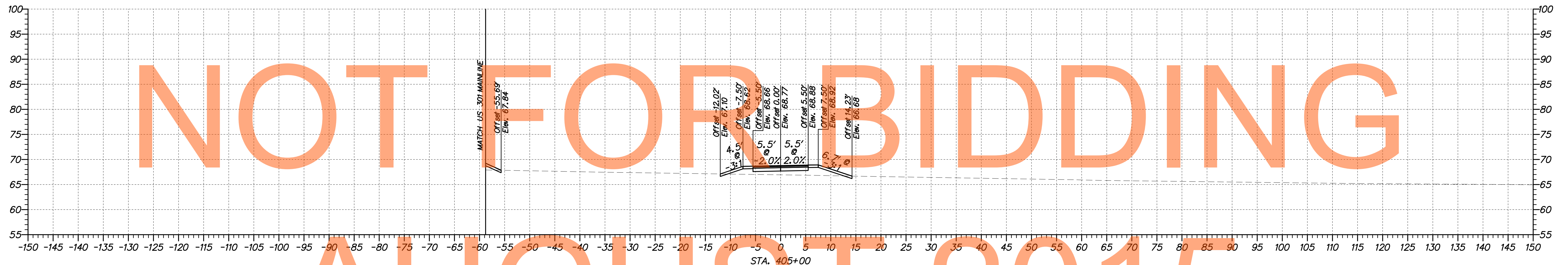
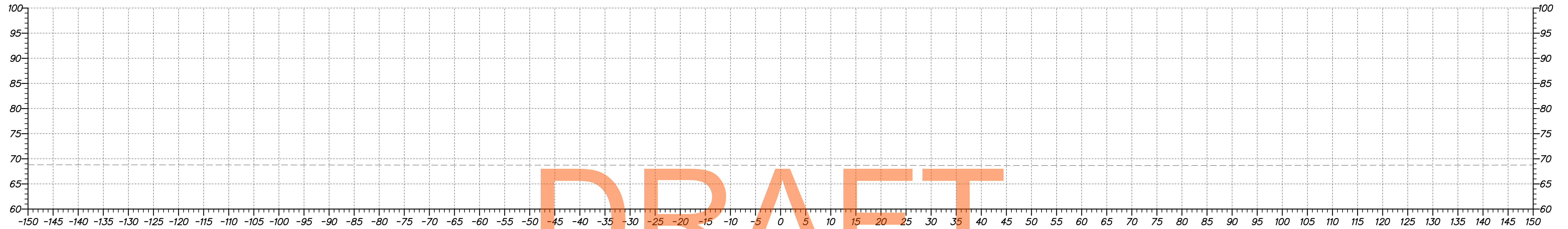

DELAWARE
DEPARTMENT OF TRANSPORTATION

ADDENDUMS / REVISIONS

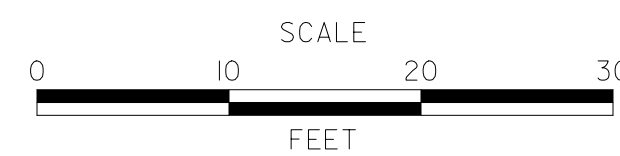

US 301,
SR 896 TO SR 1

CONTRACT
T200911308
COUNTY
NEW CASTLE

BRIDGE NO.
DESIGNED BY: WJD
CHECKED BY: MAA

CROSS SECTIONS
NB EMERGENCY RAMP
STA. 404+50 TO STA. 405+34

SHEET NO.
166
TOTAL SHTS.
337

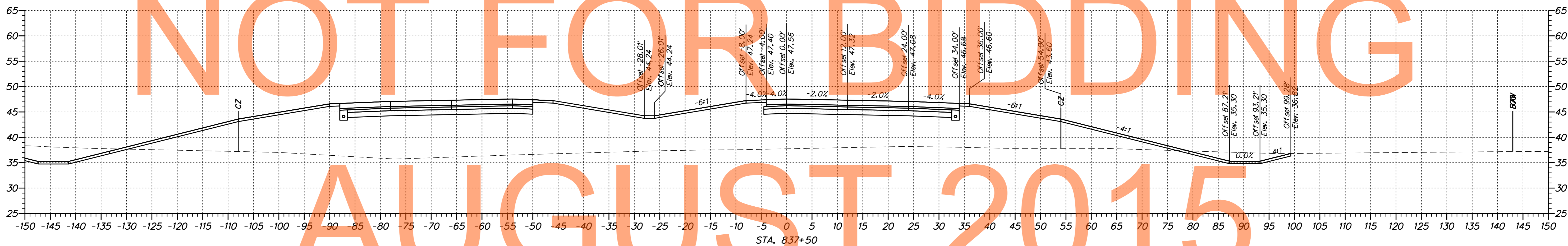
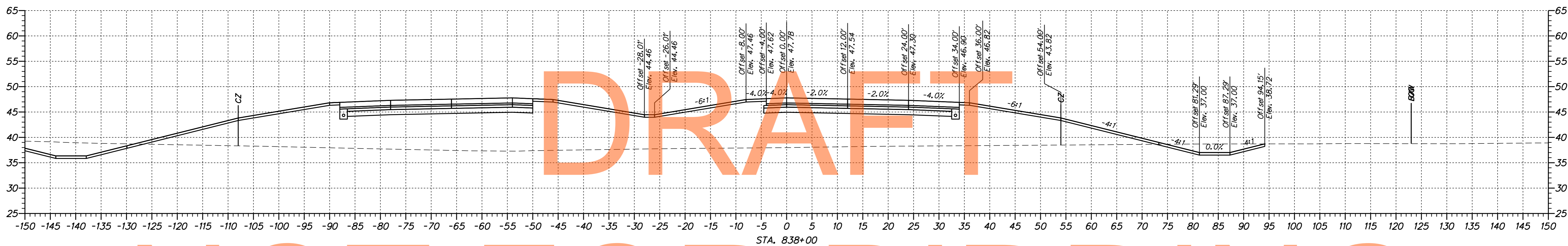
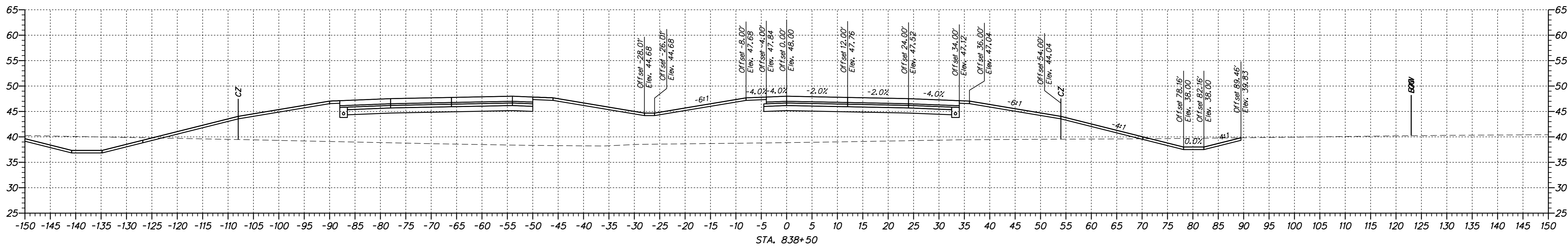

DRAFT

NOT FOR BIDDING

AUGUST 2015

n:\1653-000\semitr\el\la\cead\XS00U301\Romps_1A.dgn
 07/31/2014 2:28:23 PM



ADDENDUMS / REVISIONS	

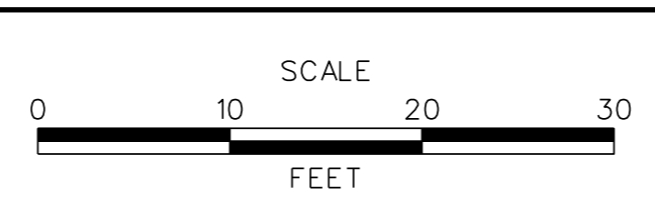

**US 301,
SR 896 TO SR 1**

CONTRACT	BRIDGE NO.
T200911308	DESIGNED BY: JAD
COUNTY	CHECKED BY: BRT
NEW CASTLE	

CROSS SECTIONS US 301 NB RAMP	SHEET NO.
	167
	TOTAL SHTS.
	337

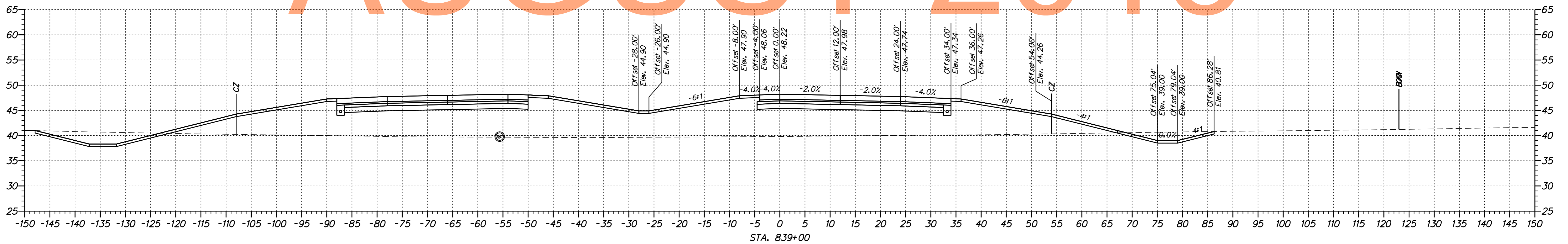
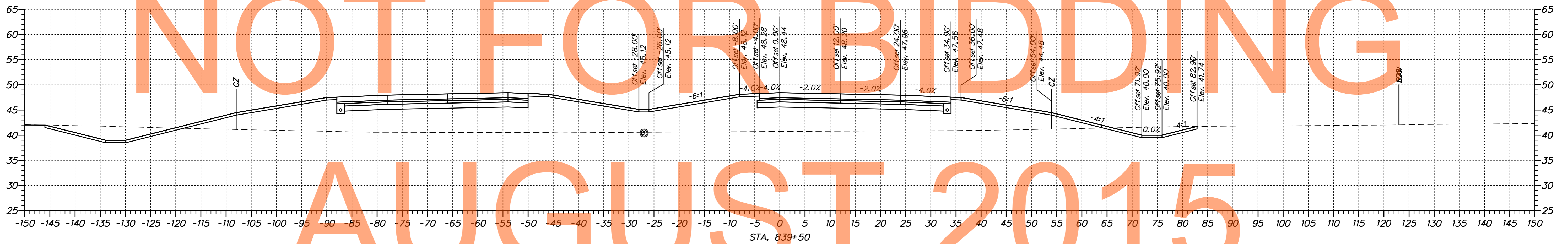
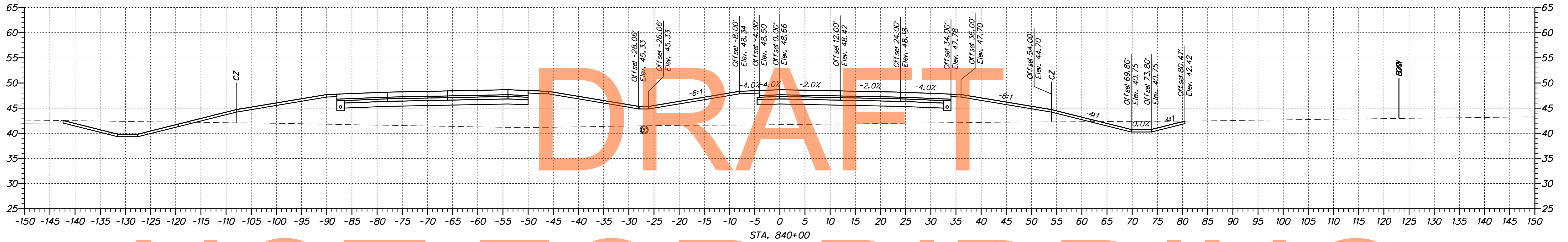
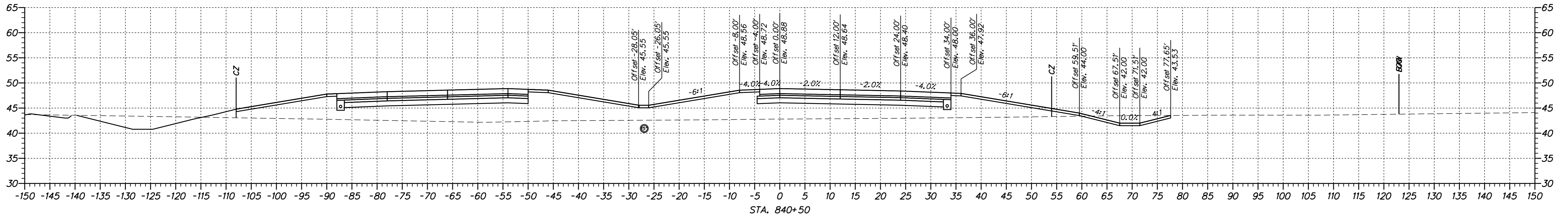

DRAFT

NOT FOR BIDDING

AUGUST 2015

n:\1653-000\semitr\el\la\cadd\X800U301\Romps_1A.dgn
 01/31/2014 2:28:23 PM



ADDENDUMS / REVISIONS	

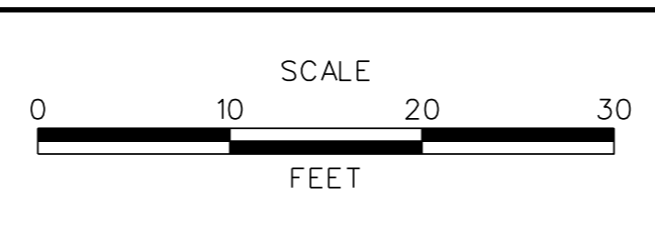

**US 301,
SR 896 TO SR 1**

CONTRACT	BRIDGE NO.
T200911308	
COUNTY	DESIGNED BY: JAD
NEW CASTLE	CHECKED BY: BRT

CROSS SECTIONS US 301 NB RAMP	SHEET NO.
	168
CROSS SECTIONS US 301 NB RAMP	TOTAL SHTS.
	337

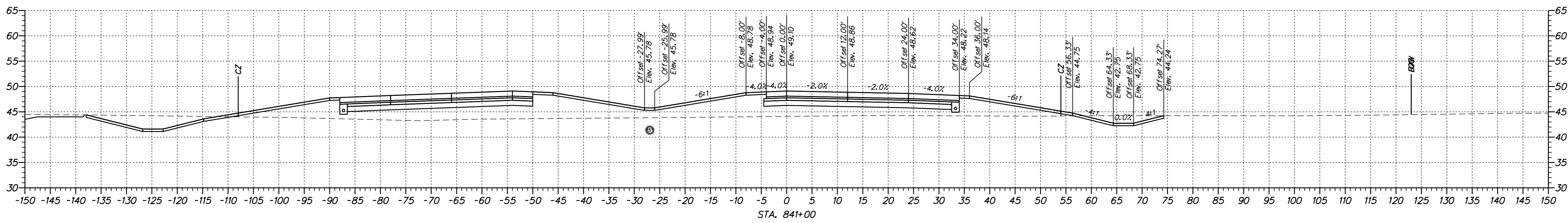
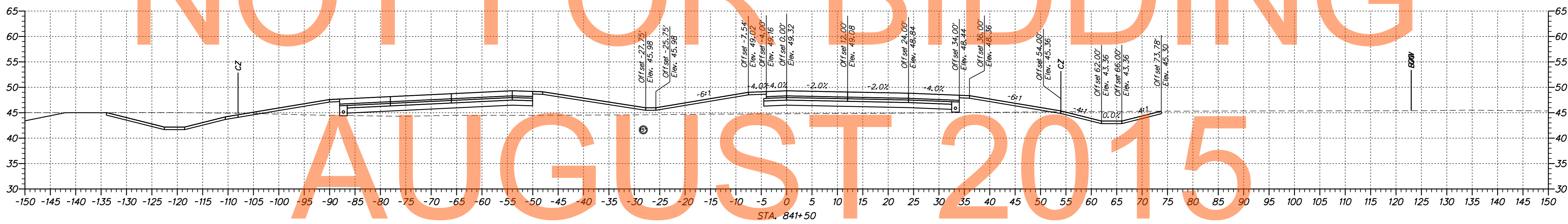
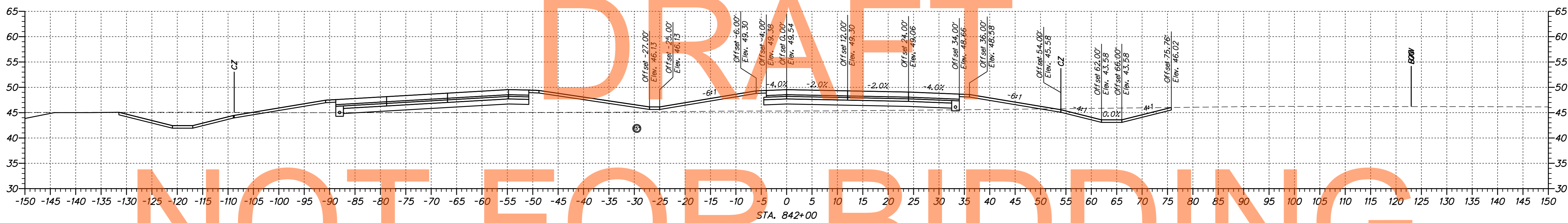
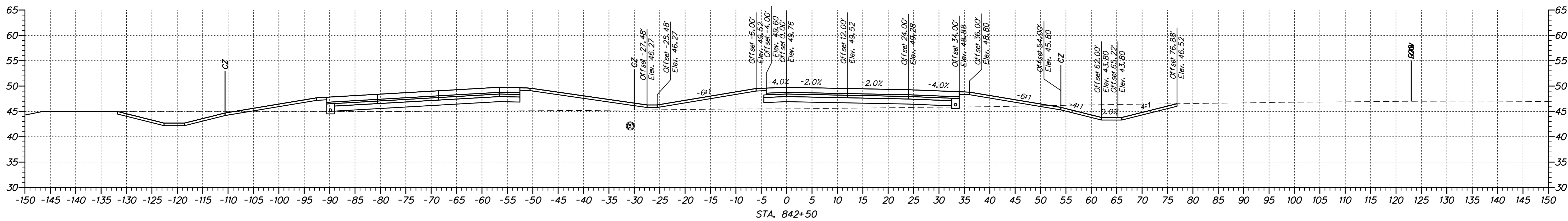

DRAFT

NOT FOR BIDDING

AUGUST 2015

p:\1653-000\semitr\el\1a_cadd\X800U301_L_Ramps_1A.dgn
 01/31/2014 2:28:23 PM



ADDENDUMS / REVISIONS	

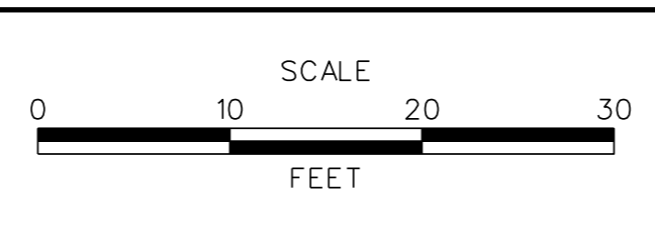

**US 301,
SR 896 TO SR 1**

CONTRACT	BRIDGE NO.
T200911308	
COUNTY	DESIGNED BY: JAD
NEW CASTLE	CHECKED BY: BRT

CROSS SECTIONS US 301 NB RAMP	SHEET NO.
	169
CROSS SECTIONS US 301 NB RAMP	TOTAL SHTS.
	337

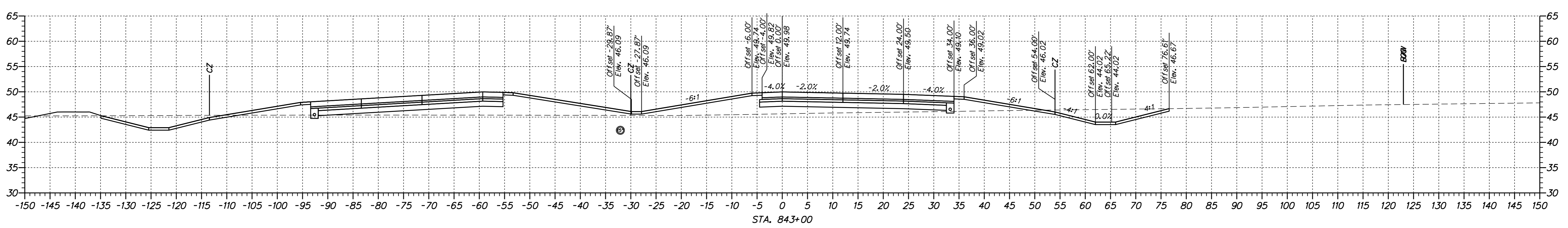
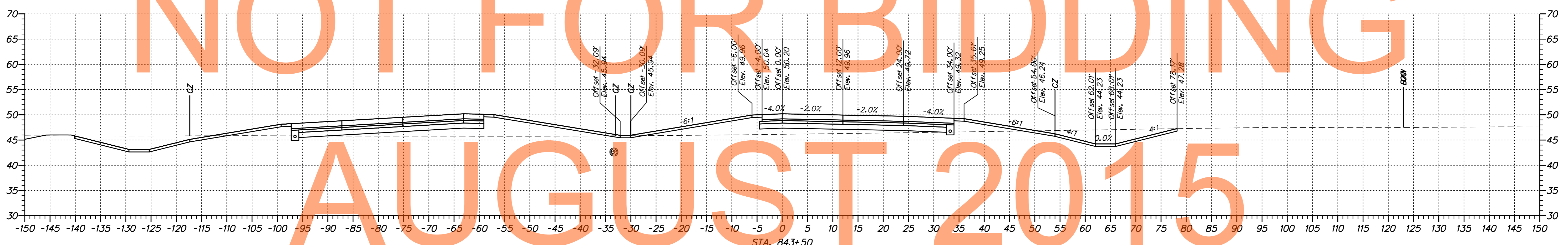
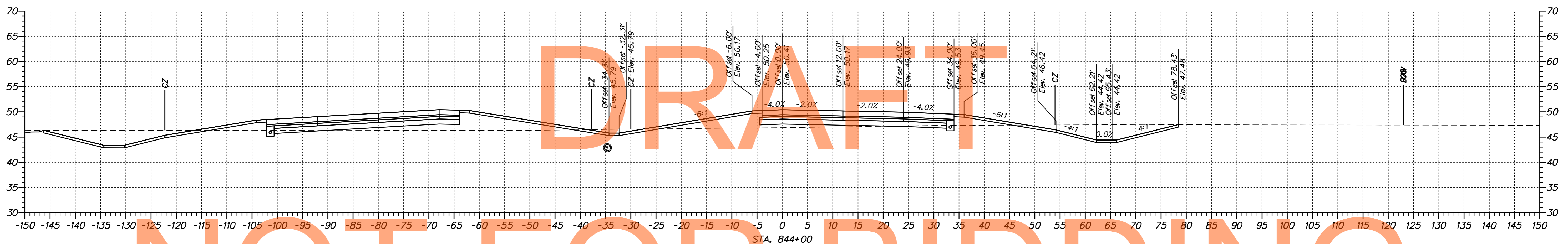
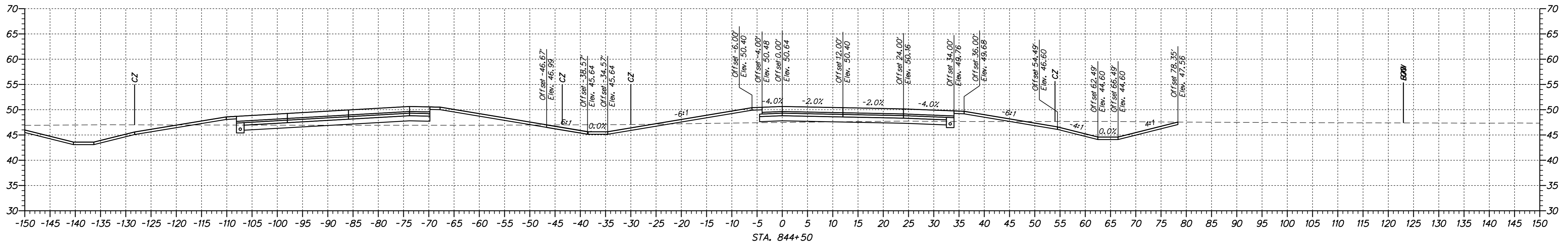

DRAFT

NOT FOR BIDDING

AUGUST 2015

n:\1653-000\scenire\1\cad\X500U301_L_Romps_1A.dgn
 01/31/2014 2:28:24 PM



ADDENDUMS / REVISIONS	

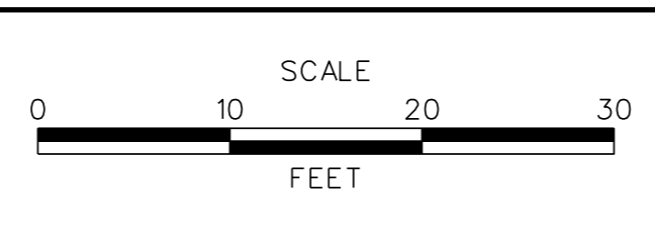

**US 301,
SR 896 TO SR 1**

CONTRACT T200911308	BRIDGE NO.
COUNTY NEW CASTLE	DESIGNED BY: JAD
	CHECKED BY: BRT

CROSS SECTIONS US 301 NB RAMP	
SHEET NO.	170
TOTAL SHTS.	337

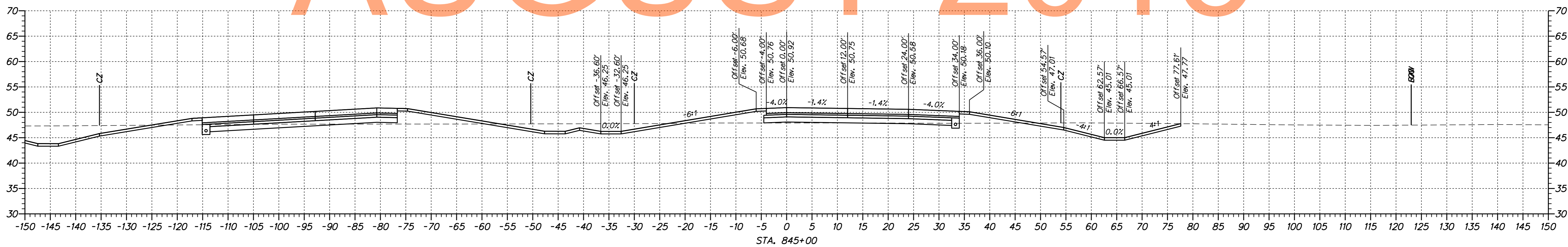
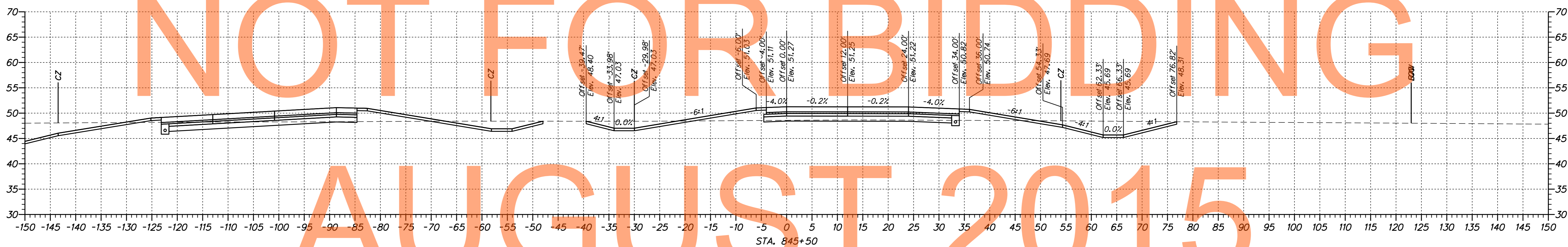
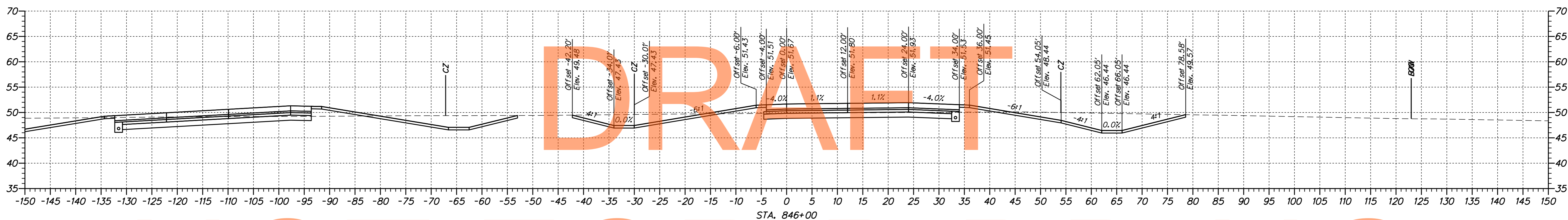
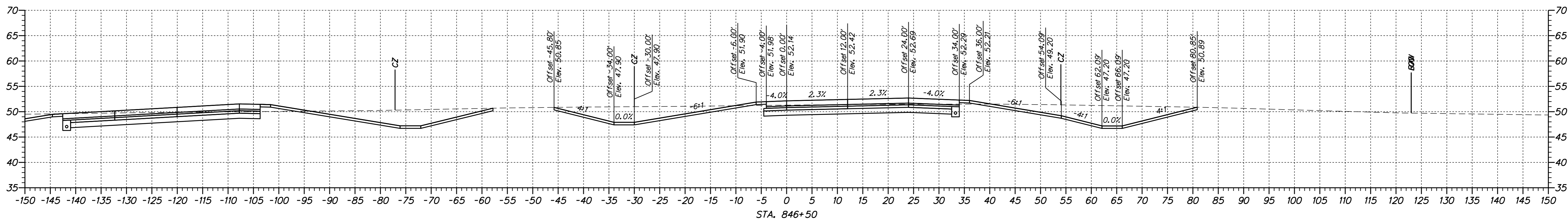

NOT FOR BIDDING
AUGUST 2015

n:\1653-000\scenire\1\cad\X500U301\Romps_1A.dgn
 07/31/2014 2:28:24 PM

ADDENDUMS / REVISIONS

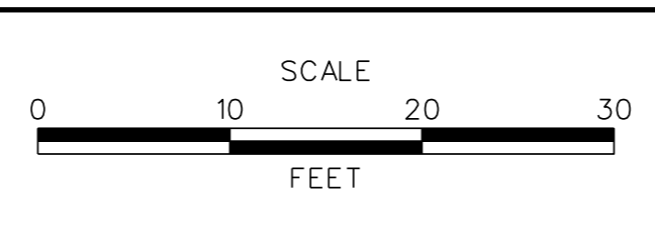

US 301,
SR 896 TO SR 1

CONTRACT	BRIDGE NO.
T200911308	
COUNTY	DESIGNED BY: JAD
NEW CASTLE	CHECKED BY: BRT

CROSS SECTIONS	SHEET NO.
US 301 NB RAMP	171
	TOTAL SHTS.
	337

\\031653-000\scen\res\1\o_cadd\X500U301\Romps_1A.dgn
07/31/2014 2:28:24 PM

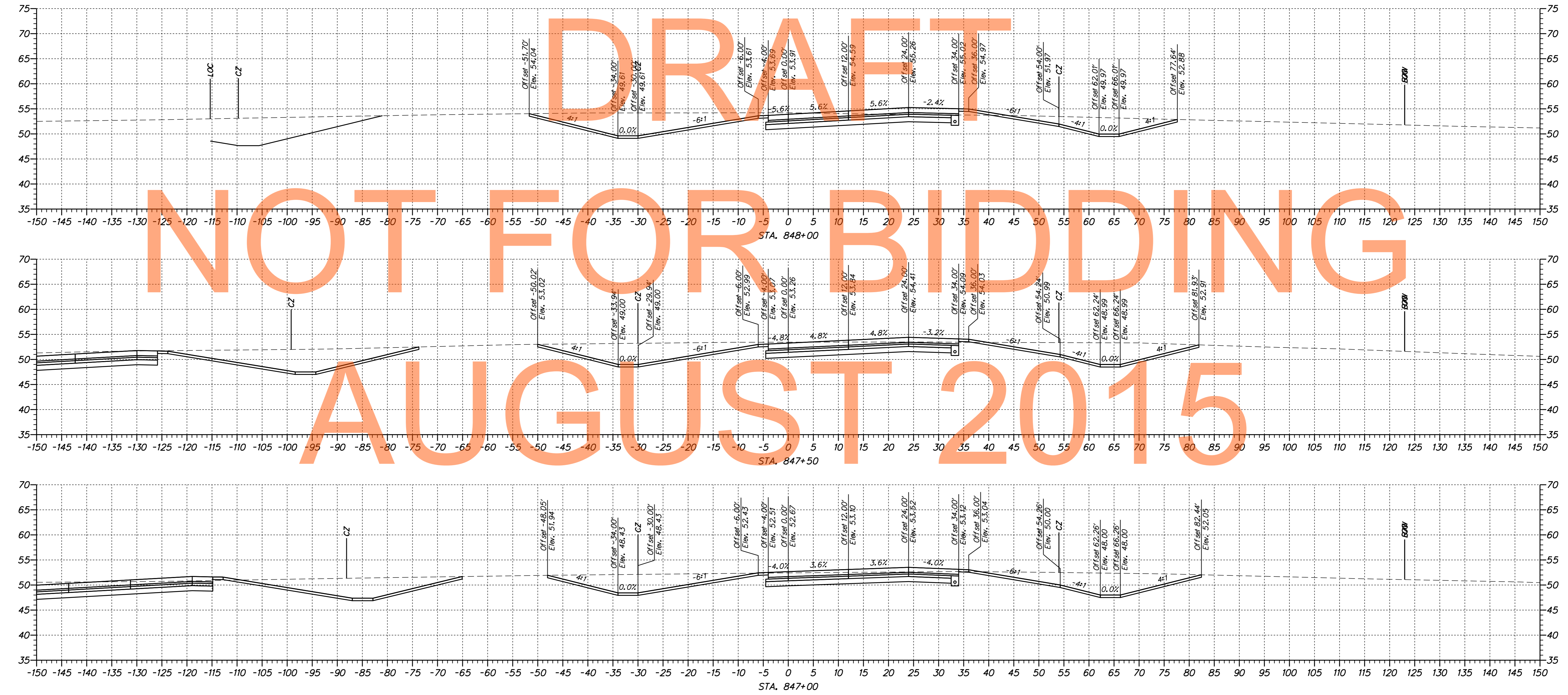

DRAFT
NOT FOR BIDDING
AUGUST 2015



ADDENDUMS / REVISIONS	

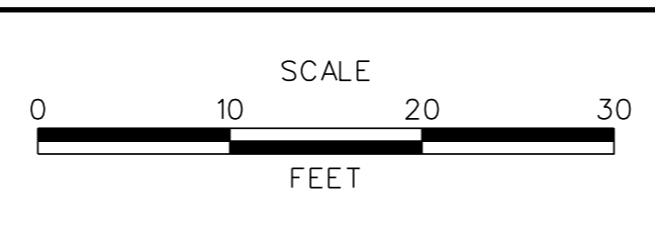

US 301,
SR 896 TO SR 1

CONTRACT T200911308	BRIDGE NO.
COUNTY NEW CASTLE	DESIGNED BY: JAD
	CHECKED BY: BRT

CROSS SECTIONS US 301 NB RAMP	SHEET NO. 172
	TOTAL SHTS. 337

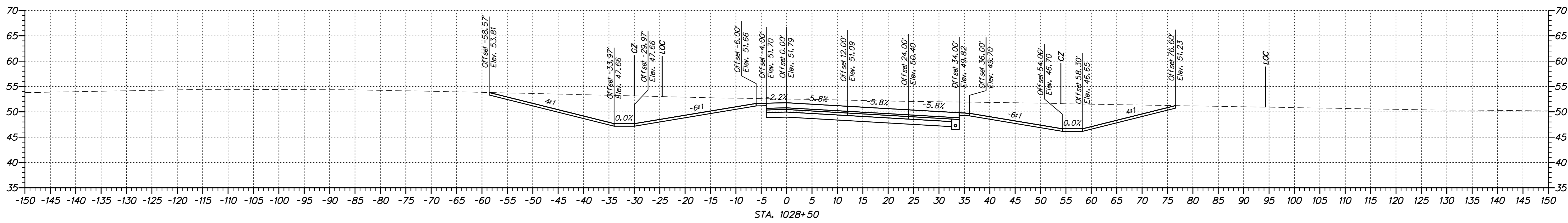
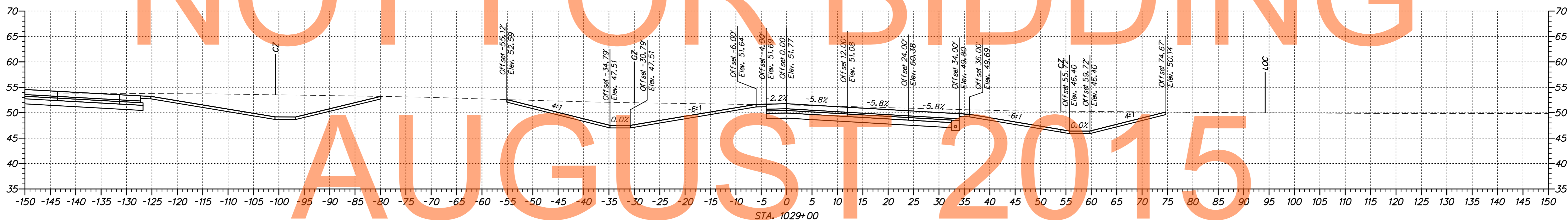
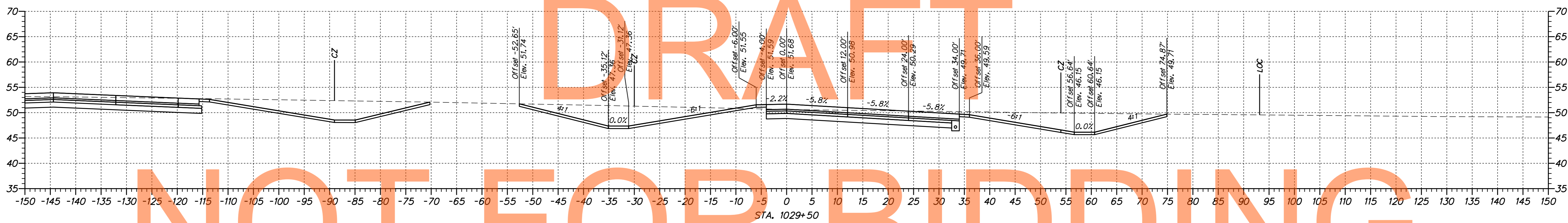
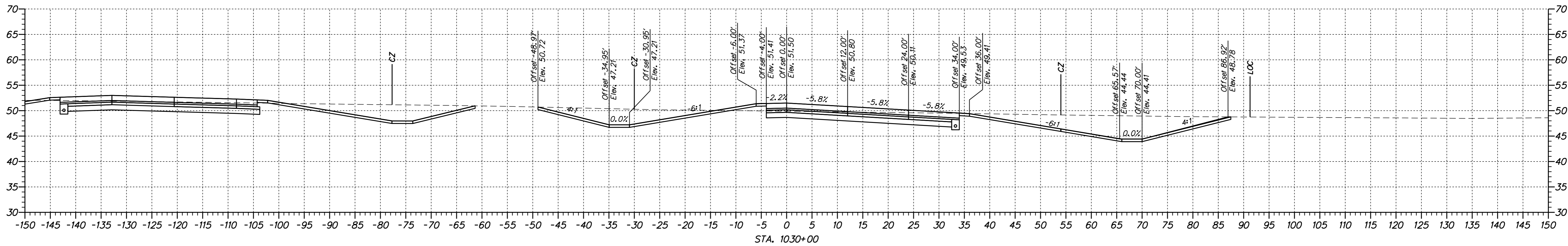

DRAFT

NOT FOR BIDDING

AUGUST 2015

n:\1653-000\semitres\la\cadd\X500U301\Ramps_1A.dgn
 03/2014 2:28:24 PM

ADDENDUMS / REVISIONS	

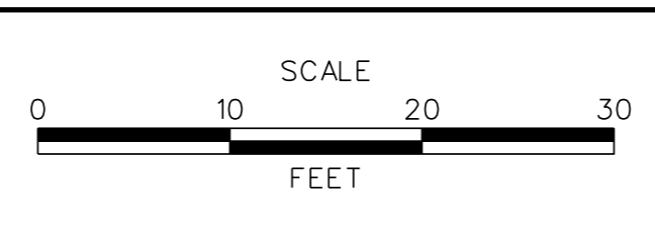

US 301,
SR 896 TO SR 1

CONTRACT	BRIDGE NO.
T200911308	
COUNTY	DESIGNED BY: JAD
NEW CASTLE	CHECKED BY: BRT

CROSS SECTIONS	SHEET NO.
RAMP Q	173
	TOTAL SHTS.
	337

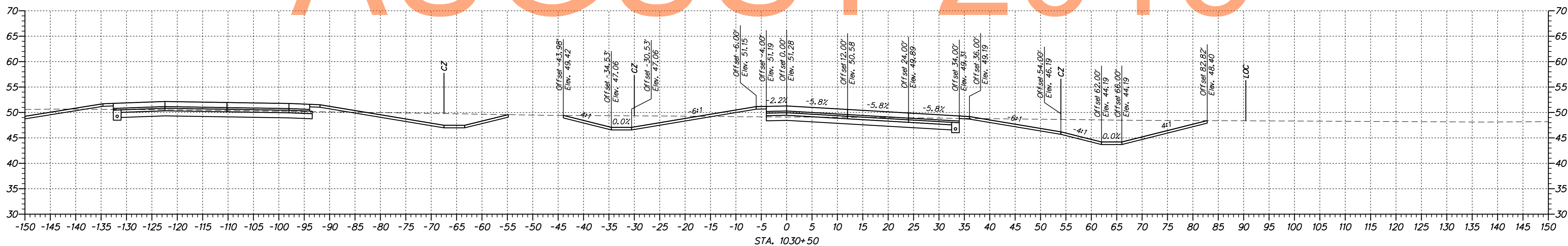
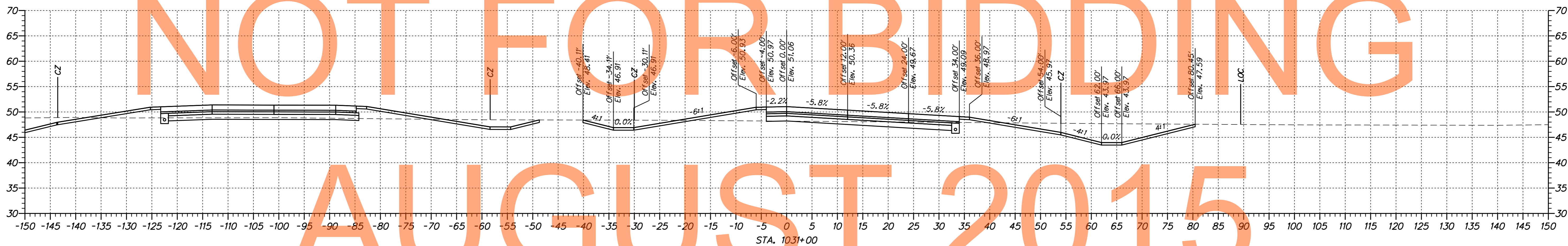
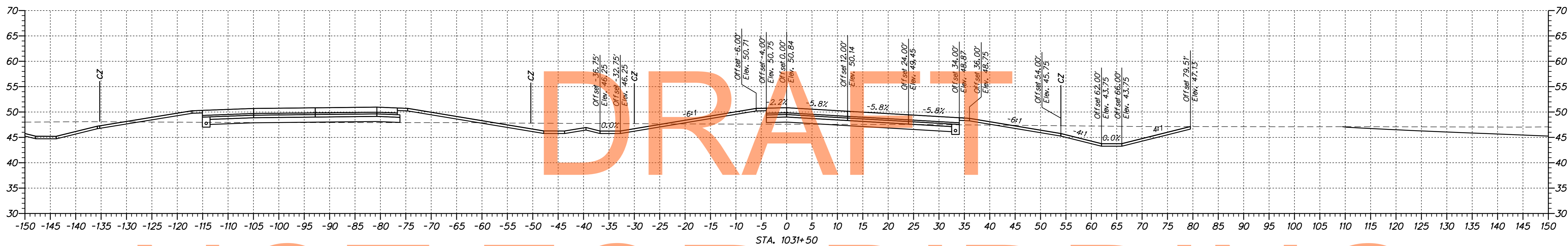
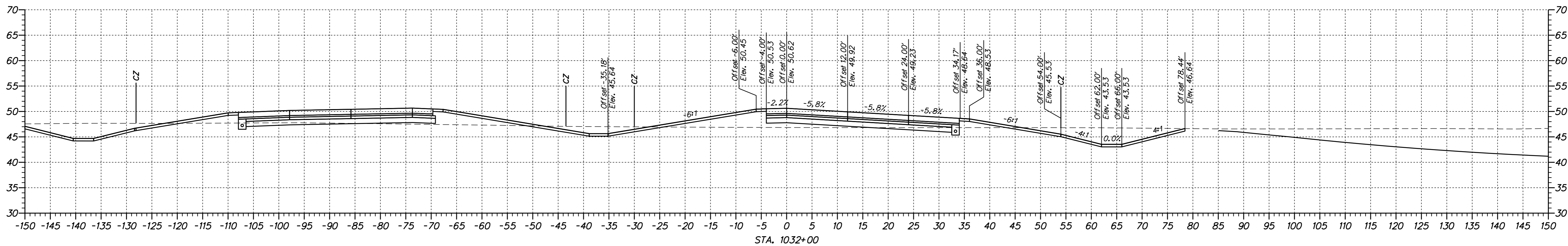

DRAFT

NOT FOR BIDDING

AUGUST 2015

n:\1653-000\scenres\1030\cadd\X500U301_L_Ramps_1A.dgn
 07/31/2014 2:28:24 PM



ADDENDUMS / REVISIONS

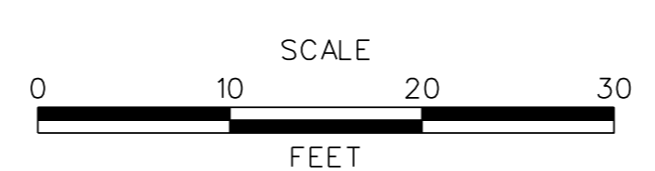

US 301,
SR 896 TO SR 1

CONTRACT T200911308	BRIDGE NO.
COUNTY NEW CASTLE	DESIGNED BY: JAD CHECKED BY: BRT

CROSS SECTIONS
RAMP Q

SHEET NO. 174
TOTAL SHTS. 337

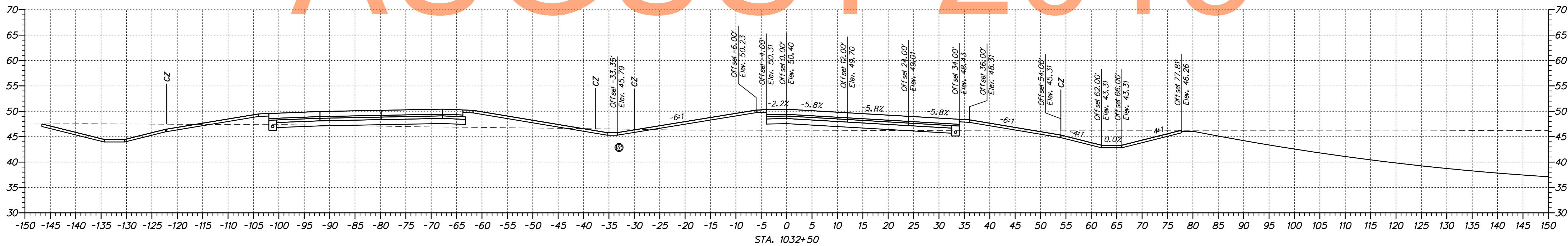
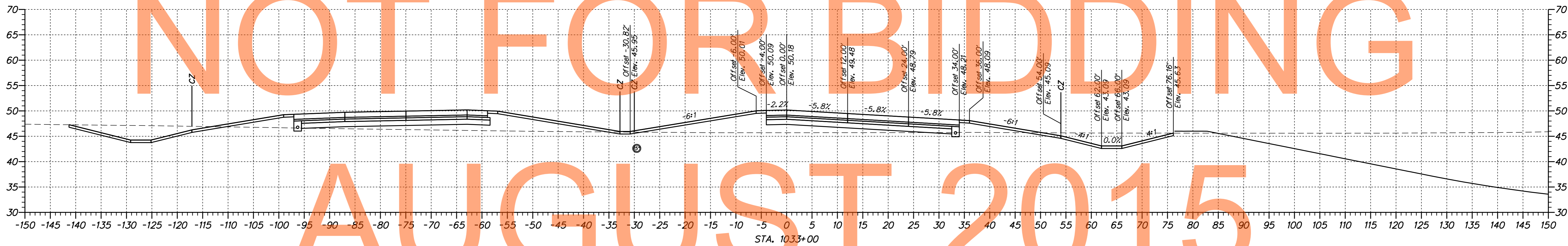
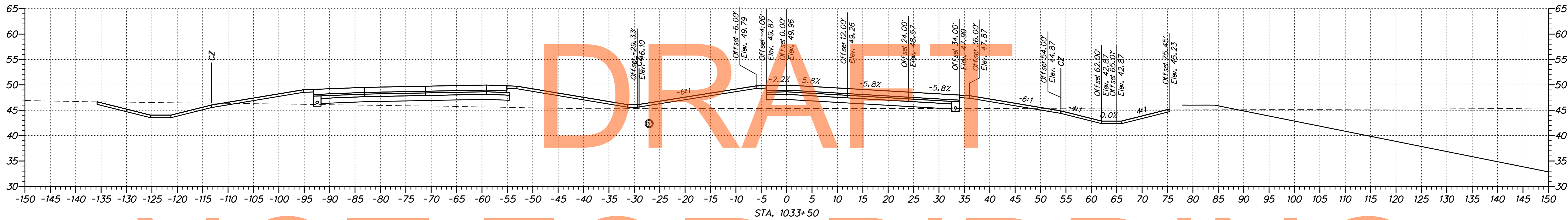
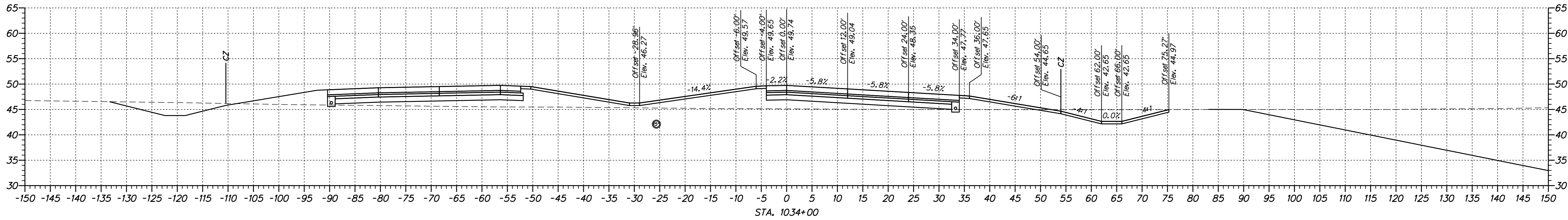

DRAFT

NOT FOR BIDDING

AUGUST 2015

n:\1653-000\scenire\1a\cadd\XS00U301\Romps_1A.dgn
 01/31/2014 2:28:24 PM



ADDENDUMS / REVISIONS	

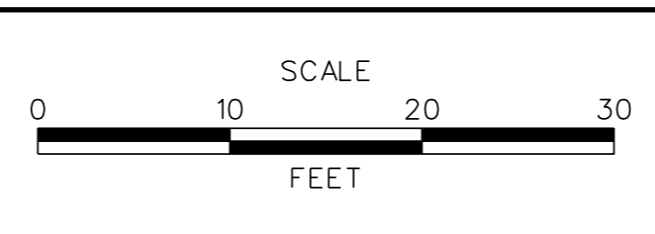

US 301,
SR 896 TO SR 1

CONTRACT T200911308	BRIDGE NO.
COUNTY NEW CASTLE	DESIGNED BY: JAD
	CHECKED BY: BRT

CROSS SECTIONS RAMP Q	SHEET NO. 175
	TOTAL SHTS. 337

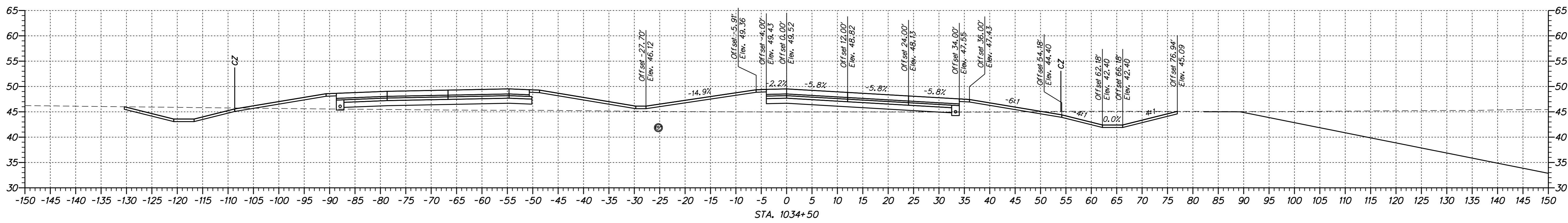
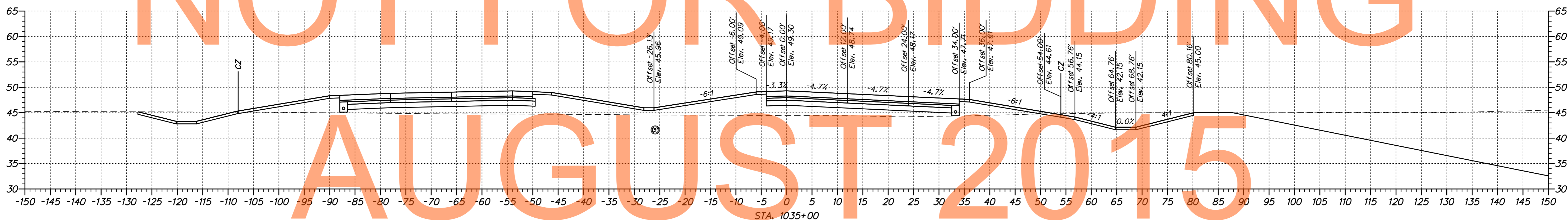
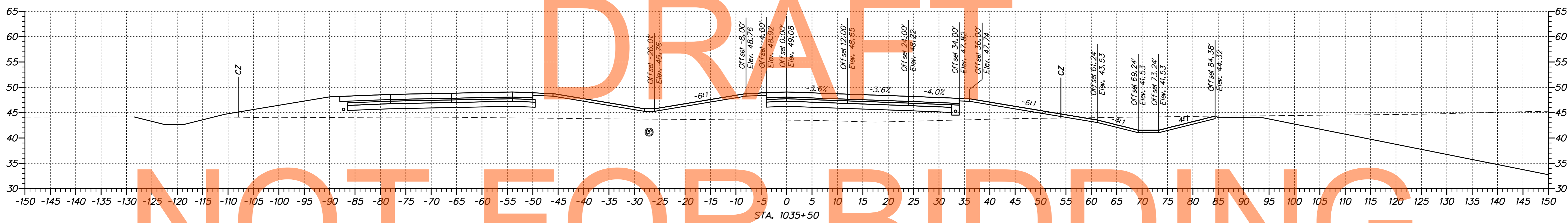
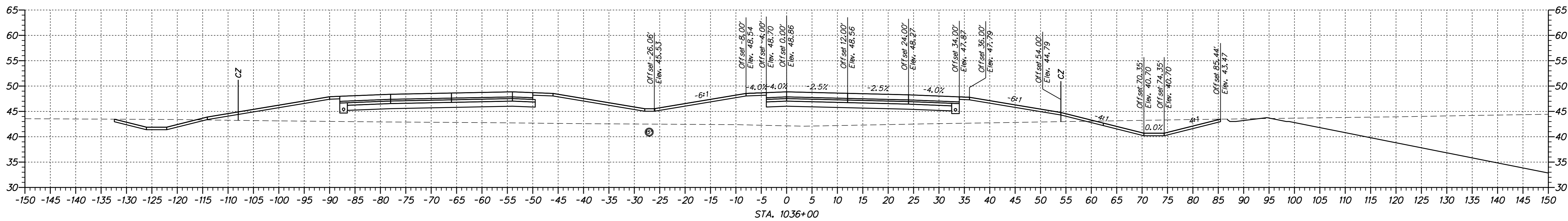

DRAFT

NOT FOR BIDDING

AUGUST 2015

n:\1653-000\semitres\1a\cead\XS00U301\Romps_1A.dgn
 01/31/2014 2:28:24 PM



ADDENDUMS / REVISIONS	

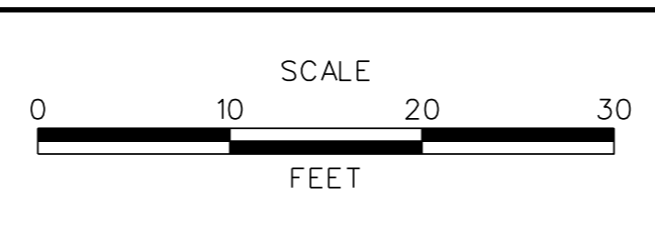

US 301,
SR 896 TO SR 1

CONTRACT	T200911308	BRIDGE NO.	
COUNTY	NEW CASTLE	DESIGNED BY:	JAD
		CHECKED BY:	BRT

CROSS SECTIONS RAMP Q	SHEET NO.	176
	TOTAL SHTS.	337

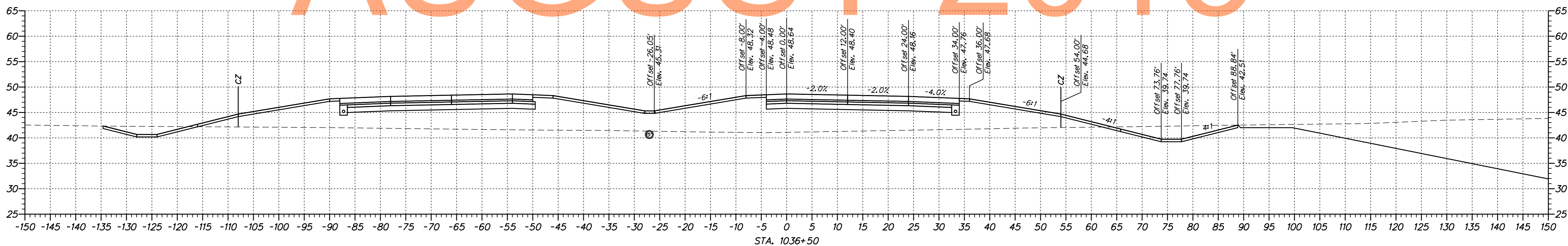
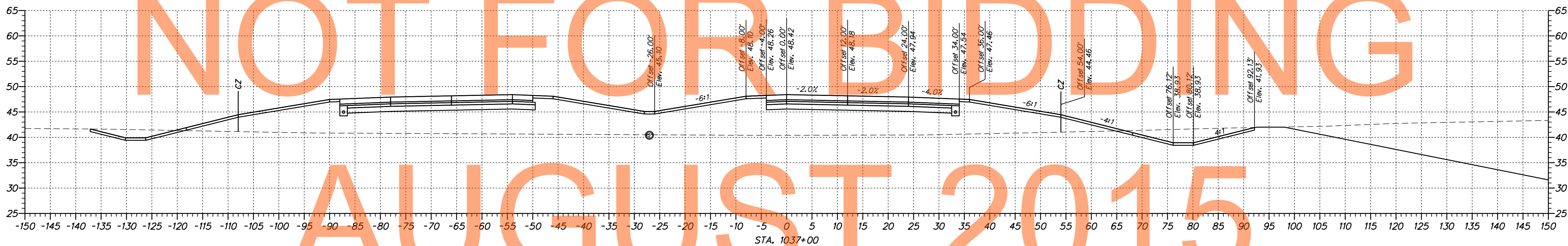
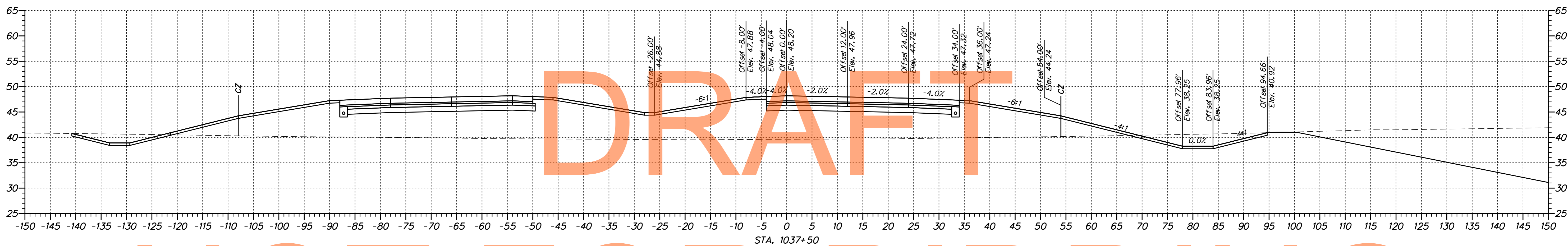
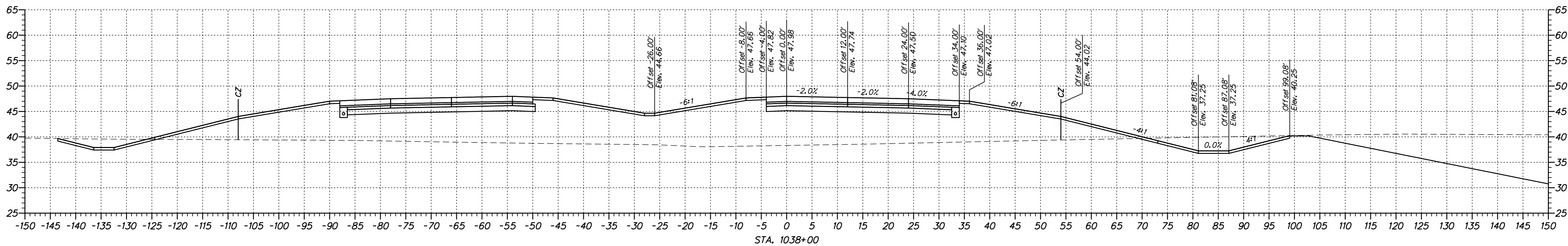

DRAFT

NOT FOR BIDDING

AUGUST 2015

n:\1653-000\semitr\el\1036ad\XS00U301_L_Ramps_1A.dgn
 01/31/2014 2:28:24 PM



ADDENDUMS / REVISIONS	

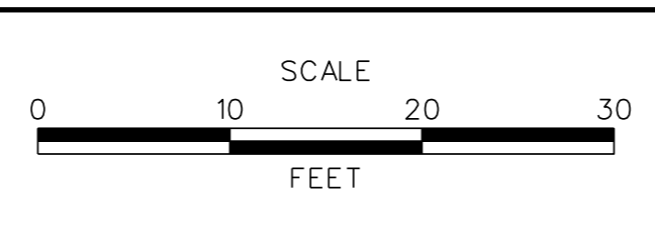

**US 301,
SR 896 TO SR 1**

CONTRACT	BRIDGE NO.
T200911308	
COUNTY	DESIGNED BY: JAD
NEW CASTLE	CHECKED BY: BRT

CROSS SECTIONS RAMP Q	SHEET NO.
	177
CROSS SECTIONS RAMP Q	TOTAL SHTS.
	337

DRAFT

NOT FOR BIDDING

AUGUST 2015

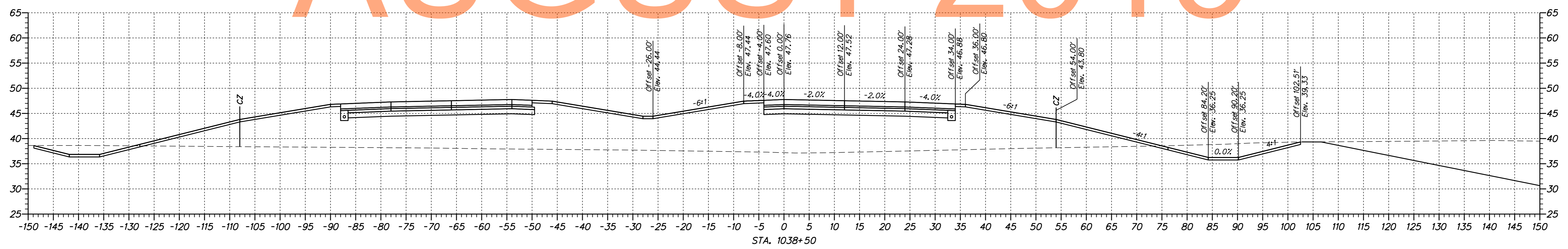
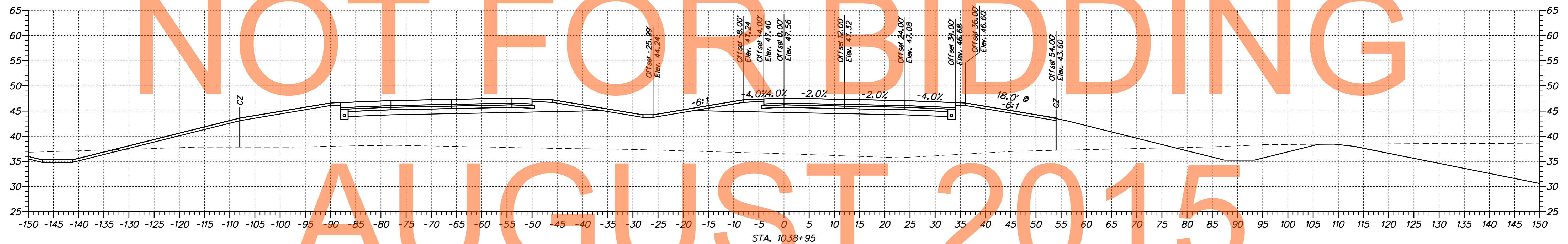

n:\31653-000\scenire\10\cad\X500U301\Ramps_1A.dgn
 07/31/2014 2:28:24 PM



ADDENDUMS / REVISIONS	



US 301,
SR 896 TO SR 1

CONTRACT	BRIDGE NO.
T200911308	DESIGNED BY: JAD
COUNTY	CHECKED BY: BRT
NEW CASTLE	

CROSS SECTIONS
RAMP Q

SHEET NO.
178
TOTAL SHTS.
337

DRAFT

NOT FOR BIDDING

AUGUST 2015

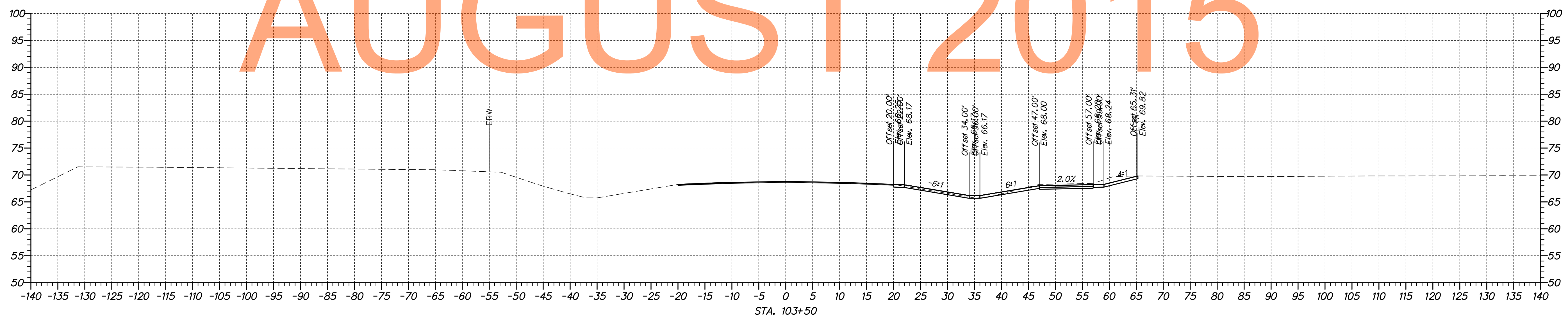
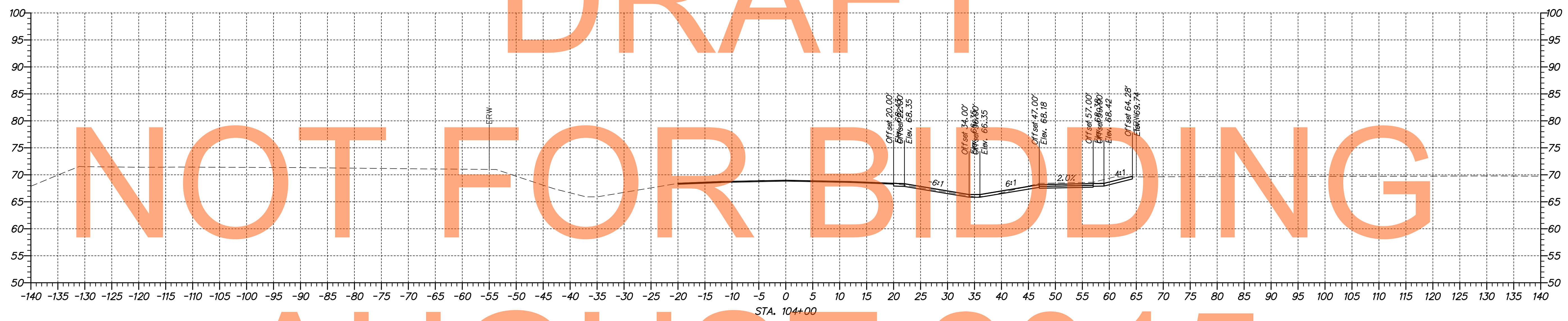
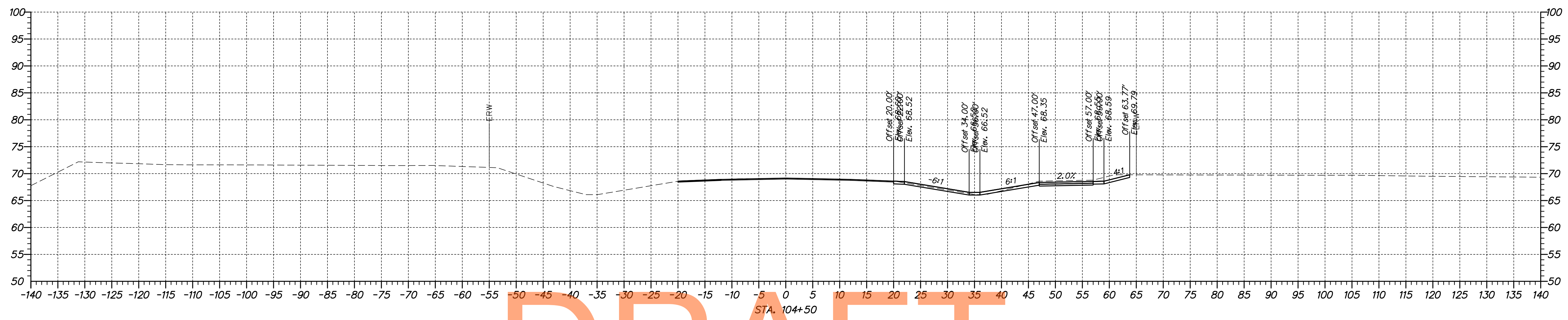

nc:\653-000\contract\1a\cadd\XS002\301_1A_JamisonCorner.dgn 10/20/2014 10:19:56 AM



ADDENDUMS / REVISIONS	

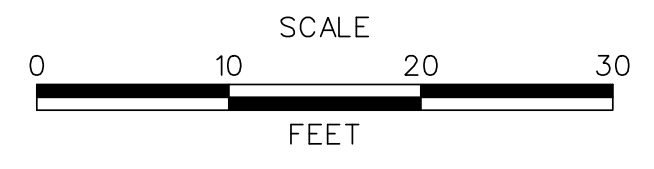

US 301, SR 896 TO SR 1

CONTRACT T200911308	BRIDGE NO.
COUNTY NEW CASTLE	DESIGNED BY: MEF
	CHECKED BY: TAO

CROSS SECTIONS JAMISON CORNER ROAD

SHEET NO. 179
TOTAL SHTS. 337

DRAFT

NOT FOR BIDDING

AUGUST 2015

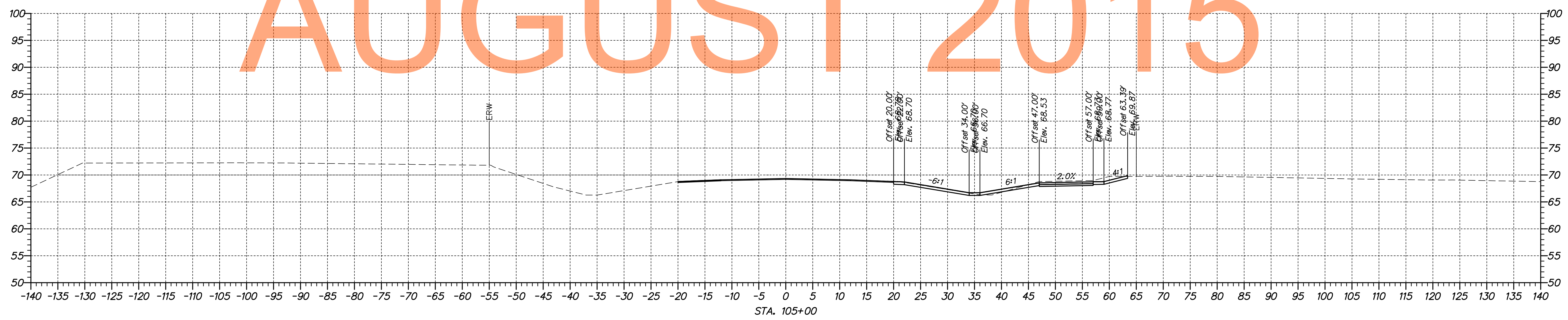
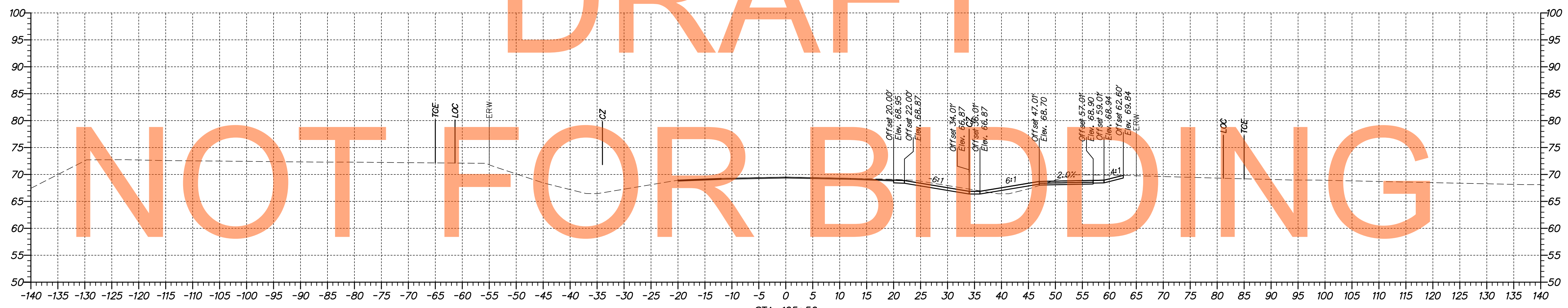
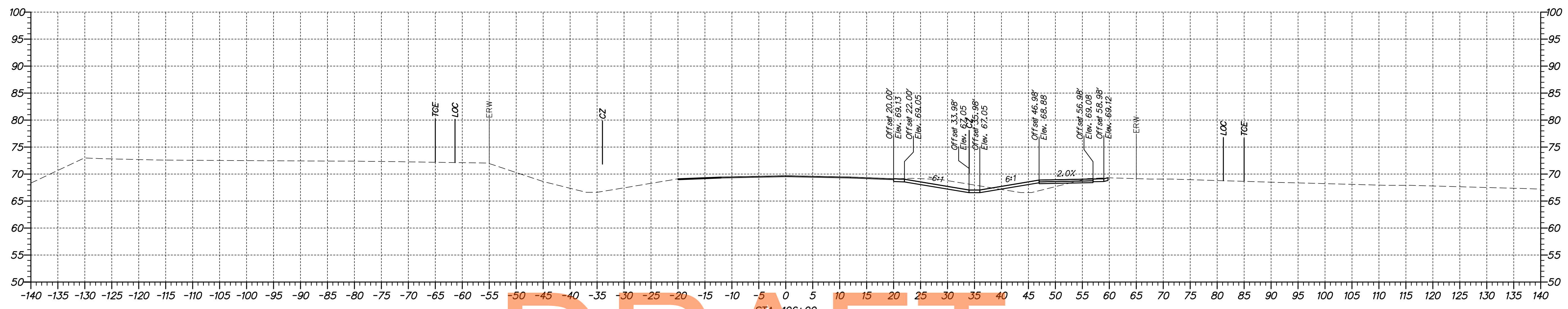

\\s3\653-000\contract\1a\cadd\XS002\301_1A_JamisonCorner.dgn 10/30/2014 10:20:01 AM



ADDENDUMS / REVISIONS	

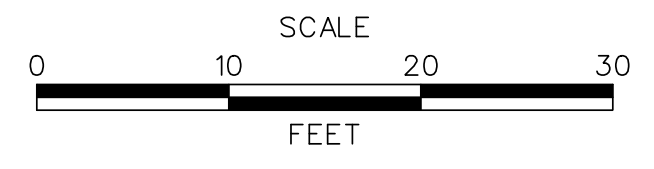

**US 301,
SR 896 TO SR 1**

CONTRACT T200911308	BRIDGE NO.
COUNTY NEW CASTLE	DESIGNED BY: MEF
	CHECKED BY: TAO

**CROSS SECTIONS
JAMISON CORNER ROAD**

SHEET NO. 180
TOTAL SHTS. 337

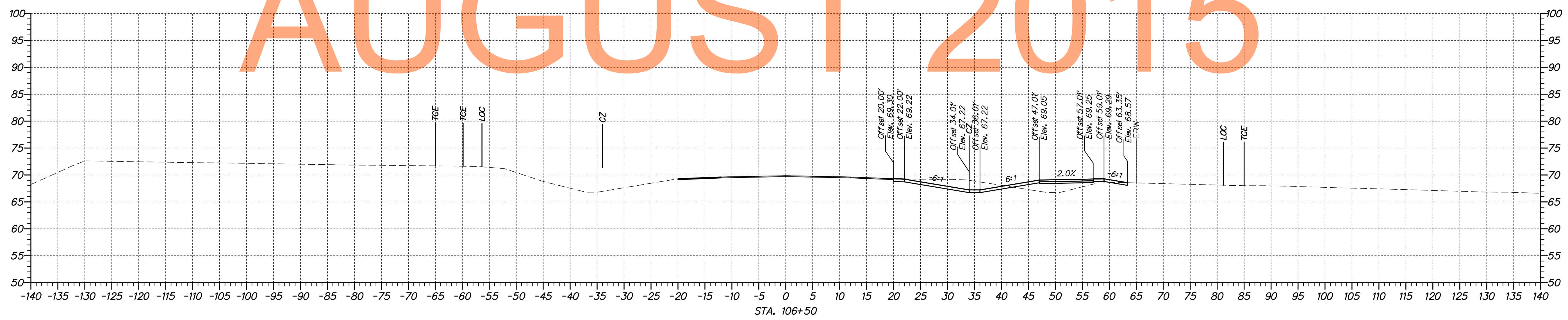
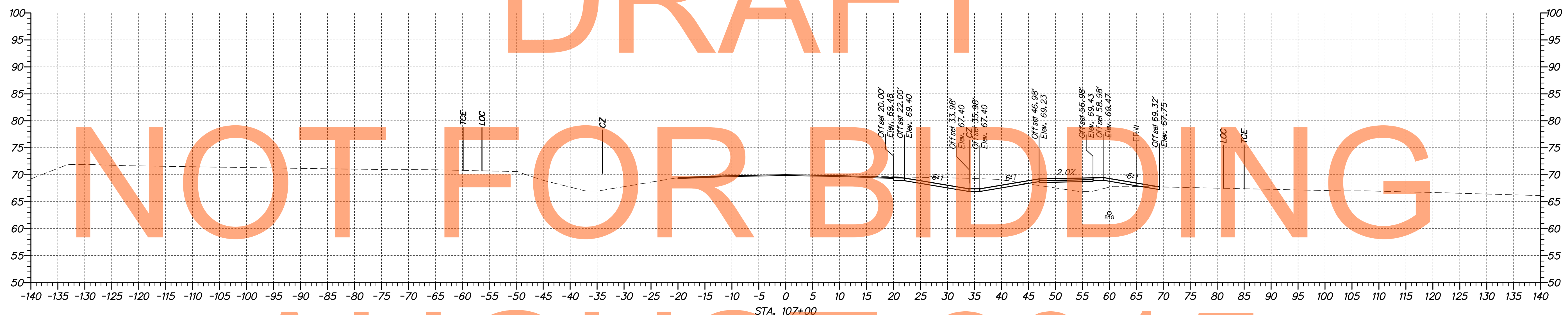
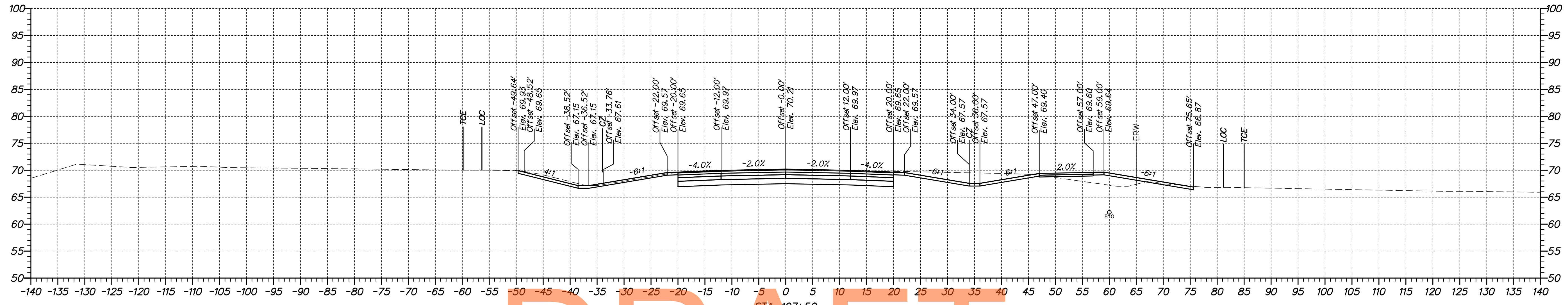

DRAFT

NOT FOR BIDDING

AUGUST 2015

p:\1653-000\sect\sect\1a\cead\XS002\301_1A_JamisonCorner.dgn 10/30/2014 10:20:03 AM



ADDENDUMS / REVISIONS	

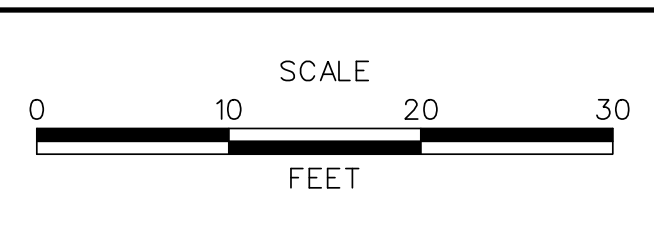

**US 301,
SR 896 TO SR 1**

CONTRACT T200911308	BRIDGE NO.
COUNTY NEW CASTLE	DESIGNED BY: MEF
	CHECKED BY: TAO

**CROSS SECTIONS
JAMISON CORNER ROAD**

SHEET NO. 181
TOTAL SHTS. 337

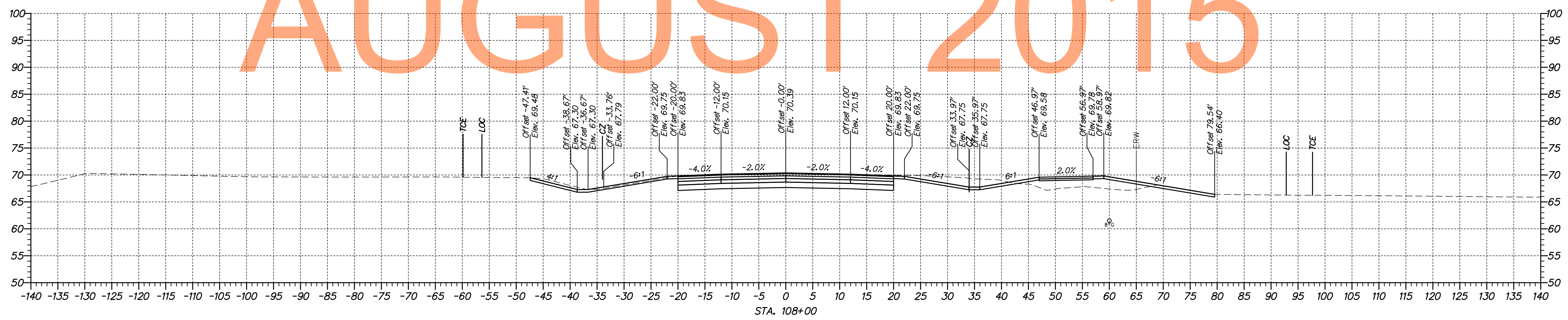
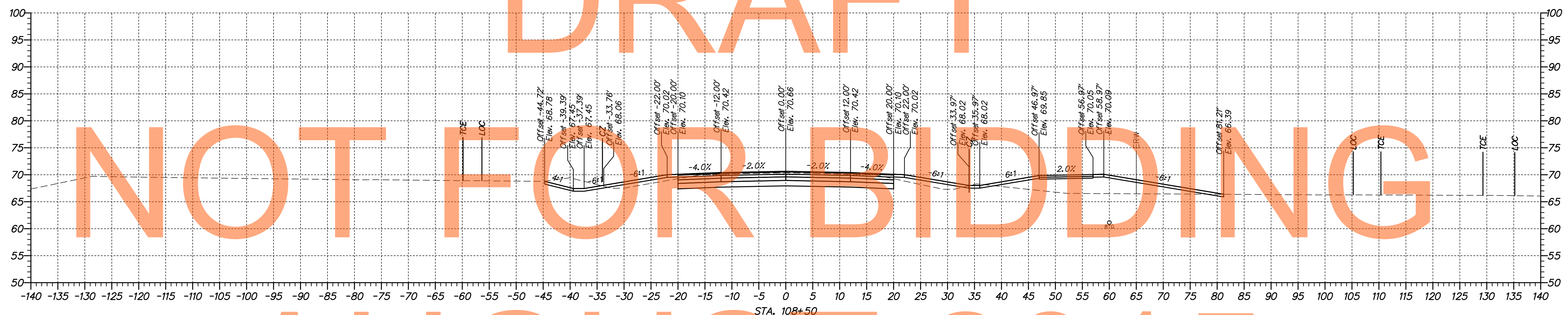
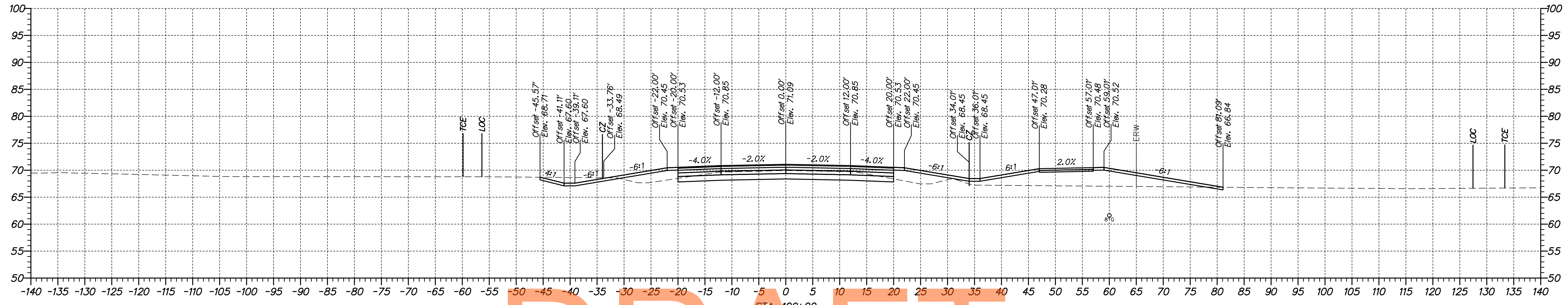

DRAFT

NOT FOR BIDDING

AUGUST 2015

p:\1653-000\com\sect\p\cead\XS002\301_1A_JamisonCorner.dgn
 07/30/2014 10:20:05 AM



ADDENDUMS / REVISIONS	

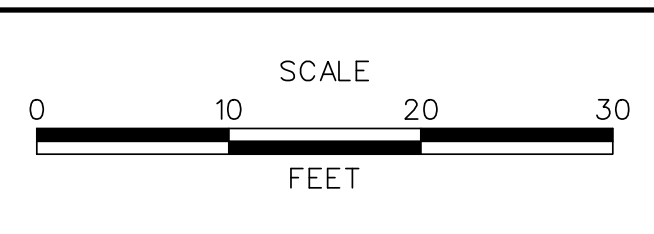

**US 301,
SR 896 TO SR 1**

CONTRACT	BRIDGE NO.
T200911308	DESIGNED BY: MEF
COUNTY	CHECKED BY: TAO
NEW CASTLE	

**CROSS SECTIONS
JAMISON CORNER ROAD**

SHEET NO.
182
TOTAL SHTS.
337

DRAFT

NOT FOR BIDDING

AUGUST 2015

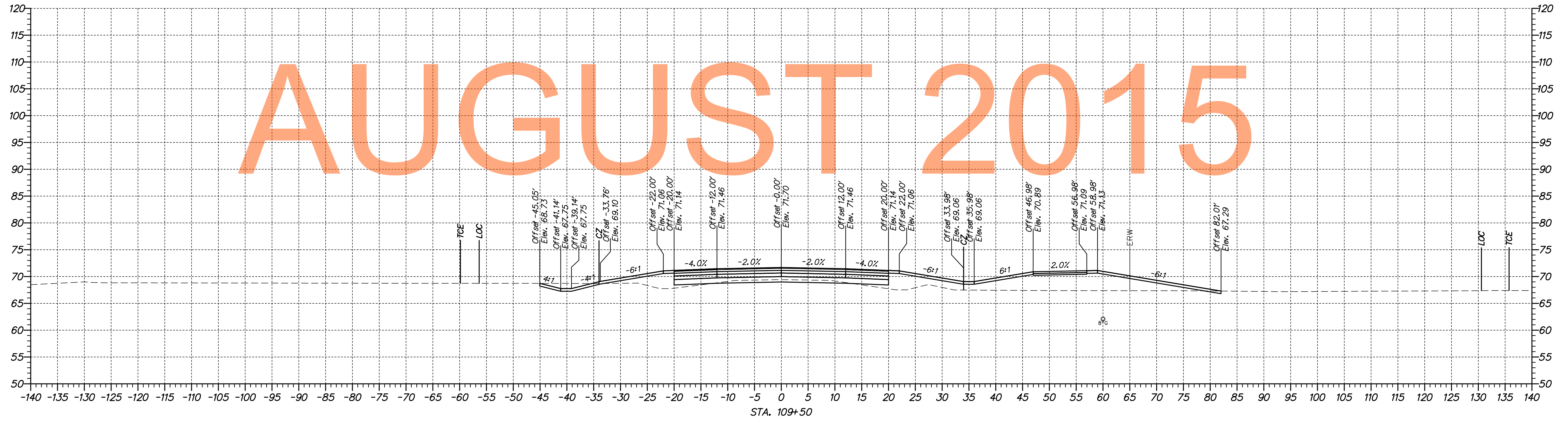
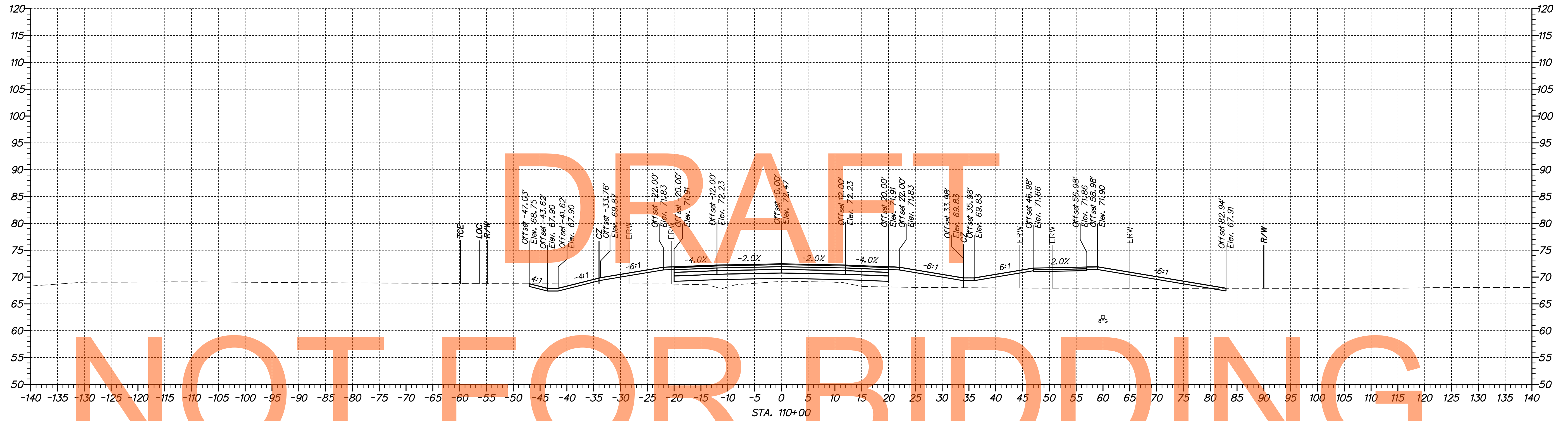

\\s002\project\10\cadd\X5002\1301_1A_JamisonCorner.dgn 10/30/2014 10:20:09 AM



ADDENDUMS / REVISIONS

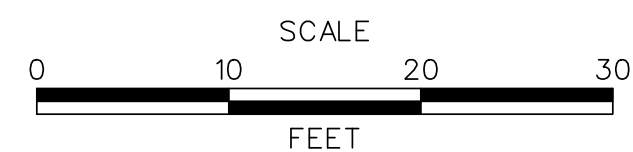

US 301,
SR 896 TO SR 1

CONTRACT	BRIDGE NO.
T200911308	DESIGNED BY: MEF
COUNTY	CHECKED BY: TAO
NEW CASTLE	

CROSS SECTIONS
JAMISON CORNER ROAD

SHEET NO.
183
TOTAL SHTS.
337

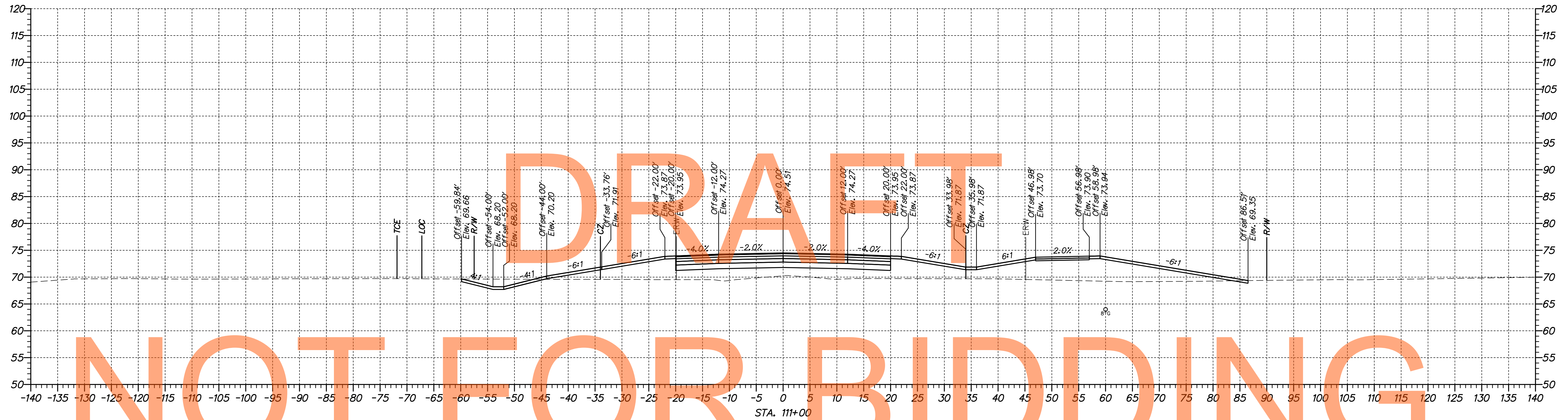

NOT FOR BIDDING

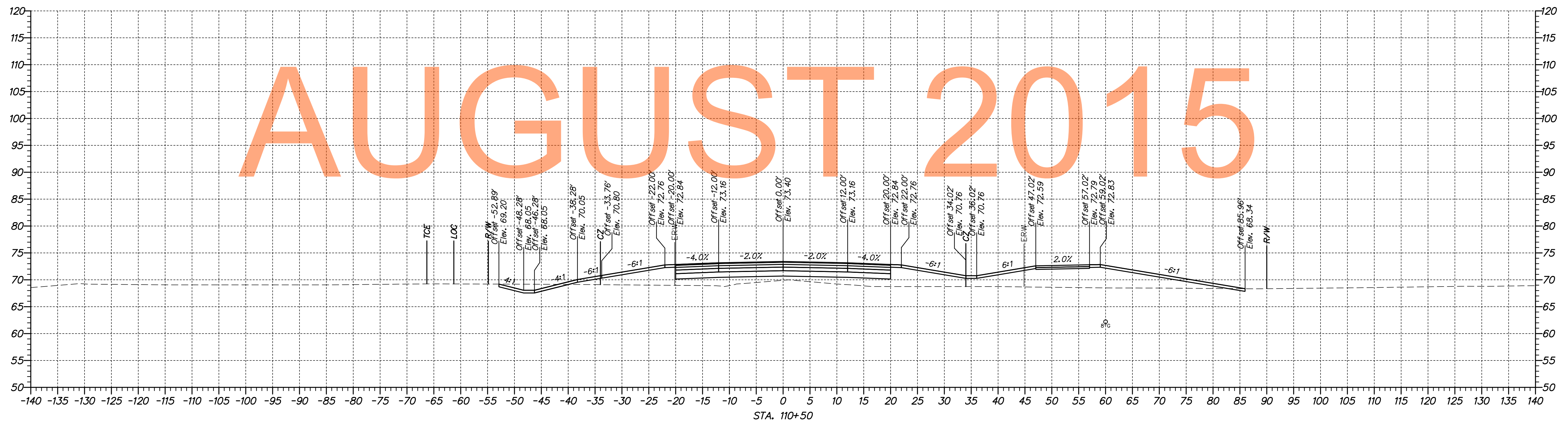

AUGUST 2015

p:\1653-000\contract\1a\cadd\XS002\301_1A_JamisonCorner.dgn
 08/30/2014 10:20:10 AM



ADDENDUMS / REVISIONS

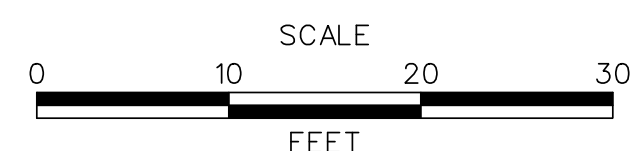

US 301,
SR 896 TO SR 1

CONTRACT	BRIDGE NO.
T200911308	DESIGNED BY: MEF
COUNTY	CHECKED BY: TAO
NEW CASTLE	

CROSS SECTIONS
JAMISON CORNER ROAD

SHEET NO.
184
TOTAL SHTS.
337

DRAFT

NOT FOR BIDDING

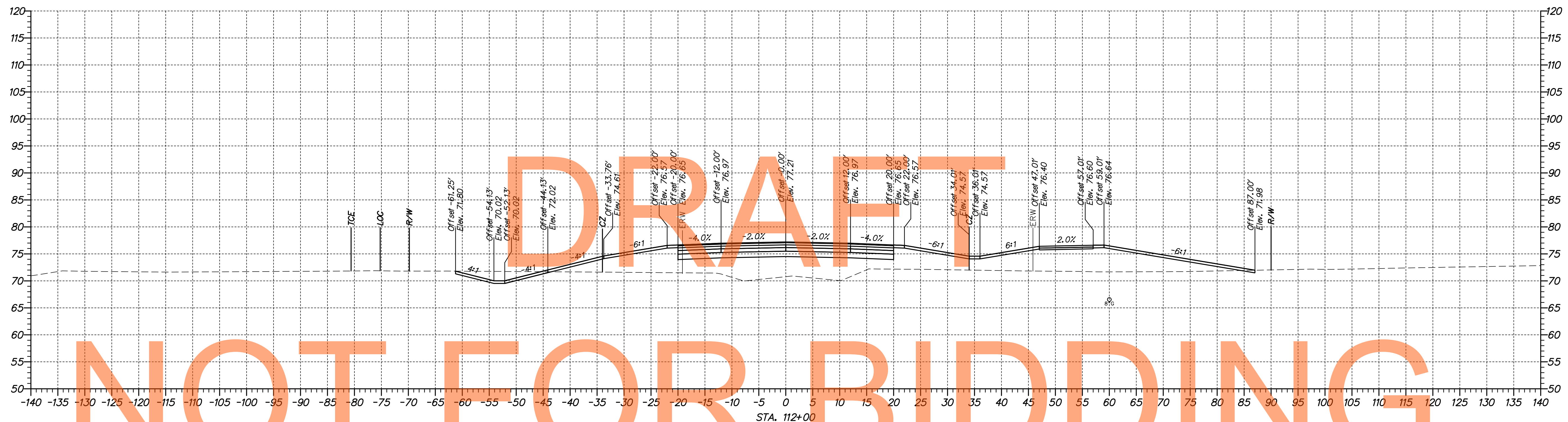

AUGUST 2015

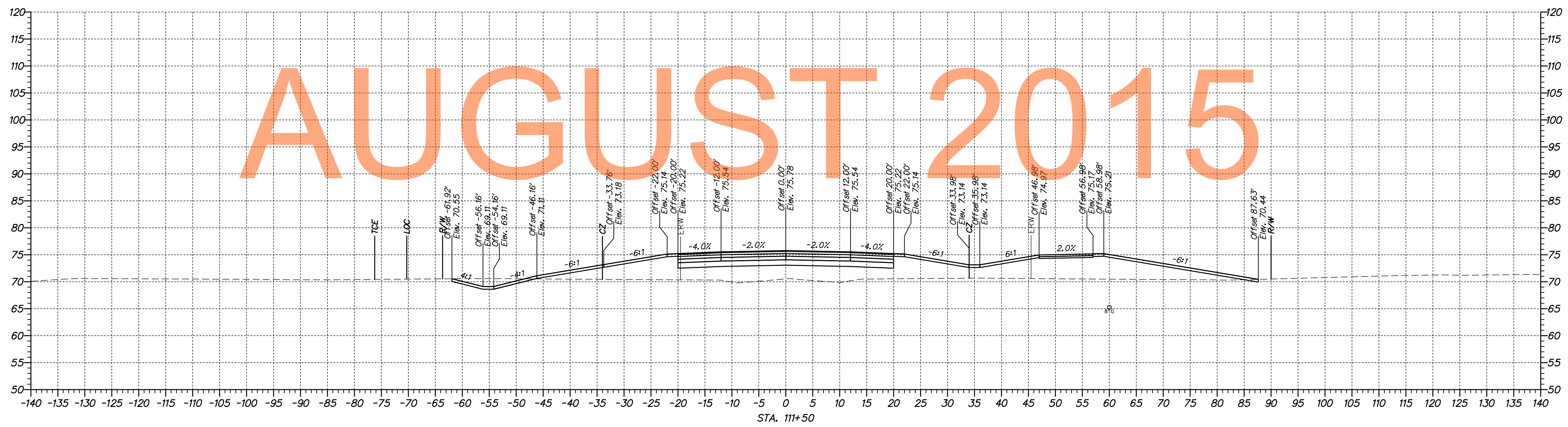

p:\1653-000\contract\1a\cadd\XS002\301_1A_JamisonCorner.dgn
 08/30/2014 10:20:12 AM



ADDENDUMS / REVISIONS	

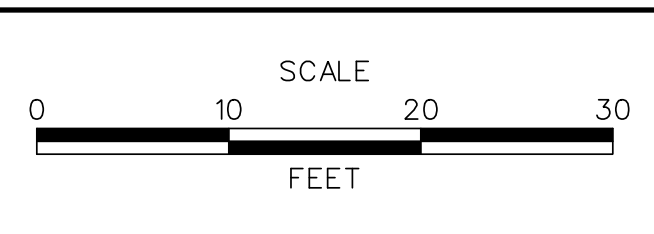

**US 301,
SR 896 TO SR 1**

CONTRACT T200911308	BRIDGE NO.
COUNTY NEW CASTLE	DESIGNED BY: MEF
	CHECKED BY: TAO

**CROSS SECTIONS
JAMISON CORNER ROAD**

SHEET NO. 185
TOTAL SHTS. 337

NOT FOR BIDDING

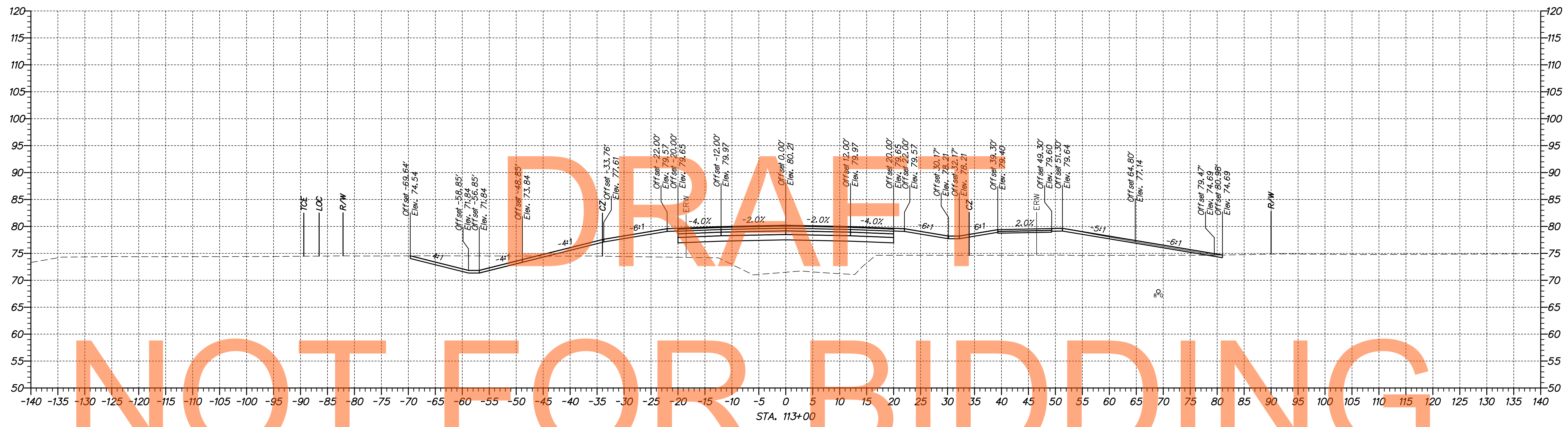

AUGUST 2015

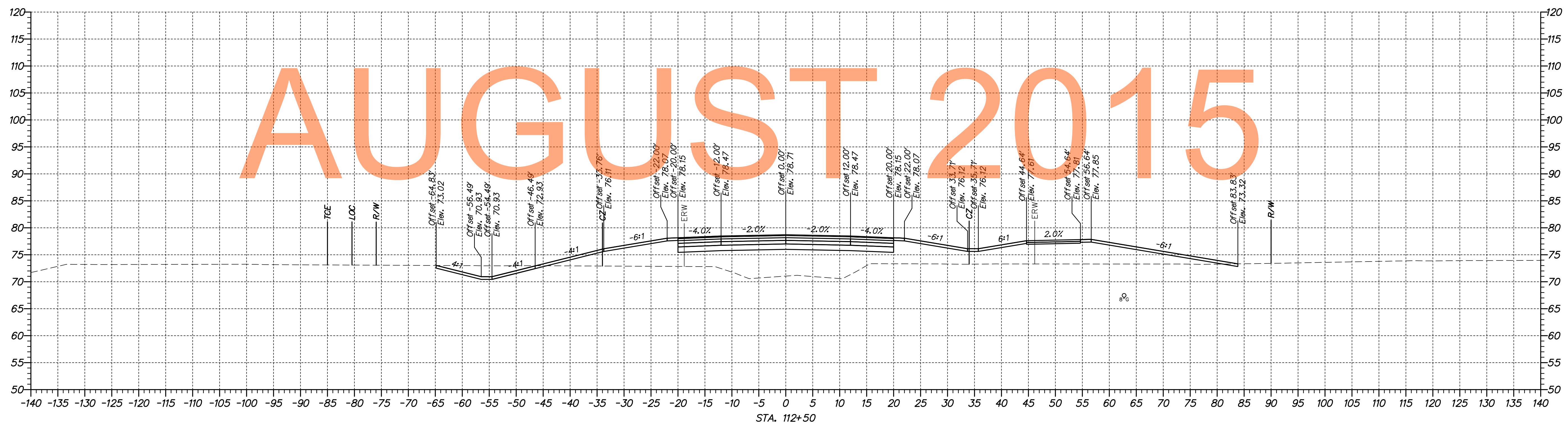

p:\1653-000\contract\1a\cadd\XS002\301_1A_JamisonCorner.dgn
 07/30/2014 10:20:14 AM



ADDENDUMS / REVISIONS	

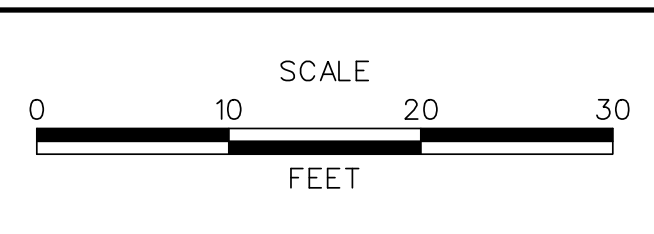

**US 301,
SR 896 TO SR 1**

CONTRACT T200911308	BRIDGE NO.
COUNTY NEW CASTLE	DESIGNED BY: MEF
	CHECKED BY: TAO

**CROSS SECTIONS
JAMISON CORNER ROAD**

SHEET NO. 186
TOTAL SHTS. 337

DRAFT

NOT FOR BIDDING

AUGUST 2015

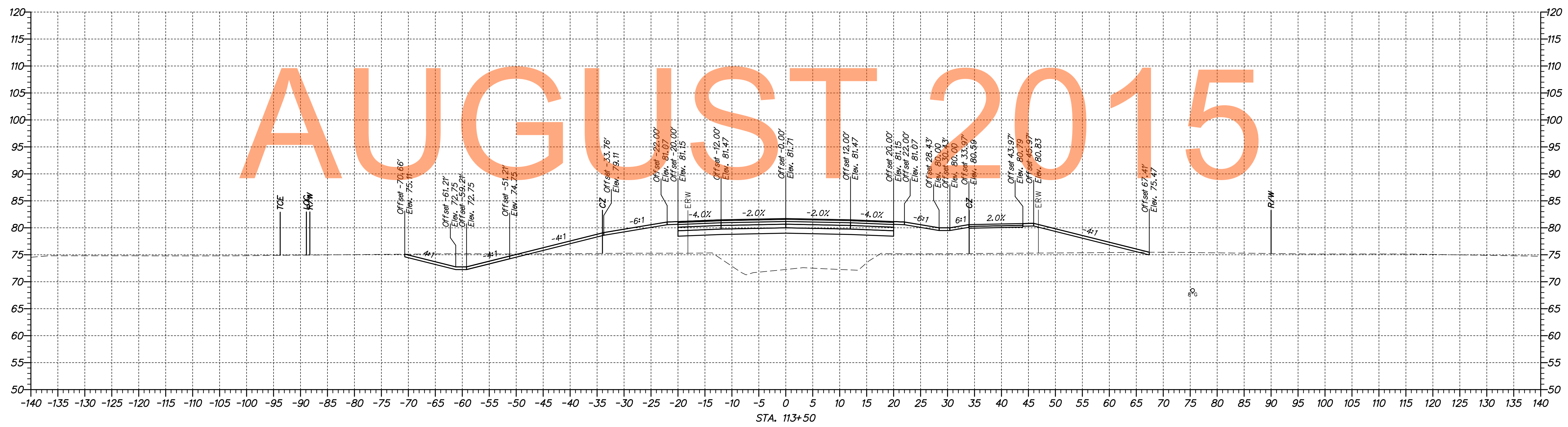
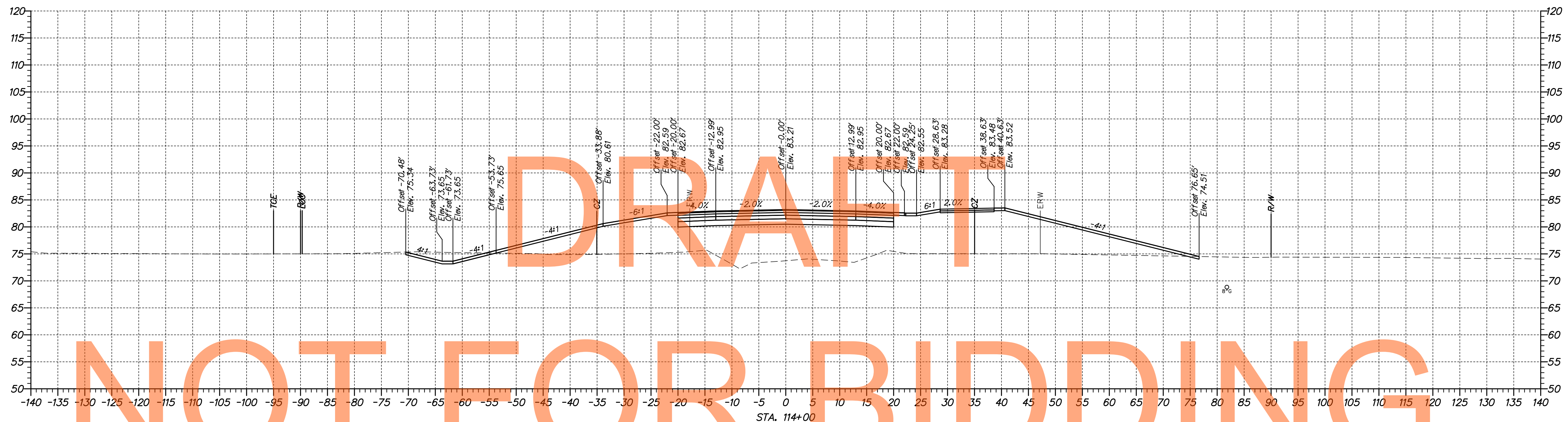

\\0653-000\contract\1a\cadd\X5002\301_1A_JamisonCorner.dgn 10/30/2014 10:20:16 AM



ADDENDUMS / REVISIONS	

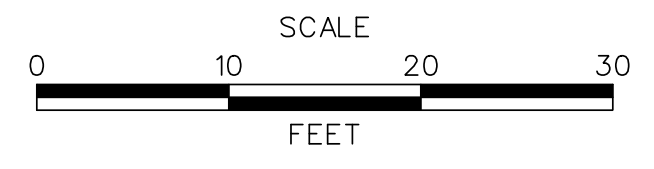

US 301,
SR 896 TO SR 1

CONTRACT	BRIDGE NO.
T200911308	
COUNTY	DESIGNED BY: MEF
NEW CASTLE	CHECKED BY: TAO

CROSS SECTIONS
JAMISON CORNER ROAD

SHEET NO.
187
TOTAL SHTS.
337

NOT FOR BIDDING

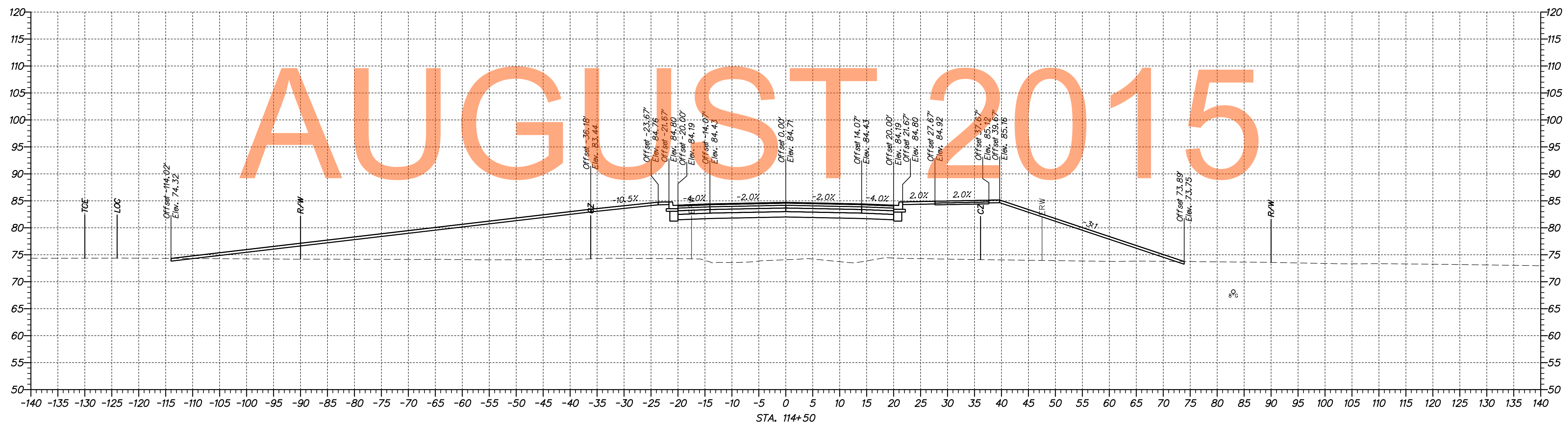
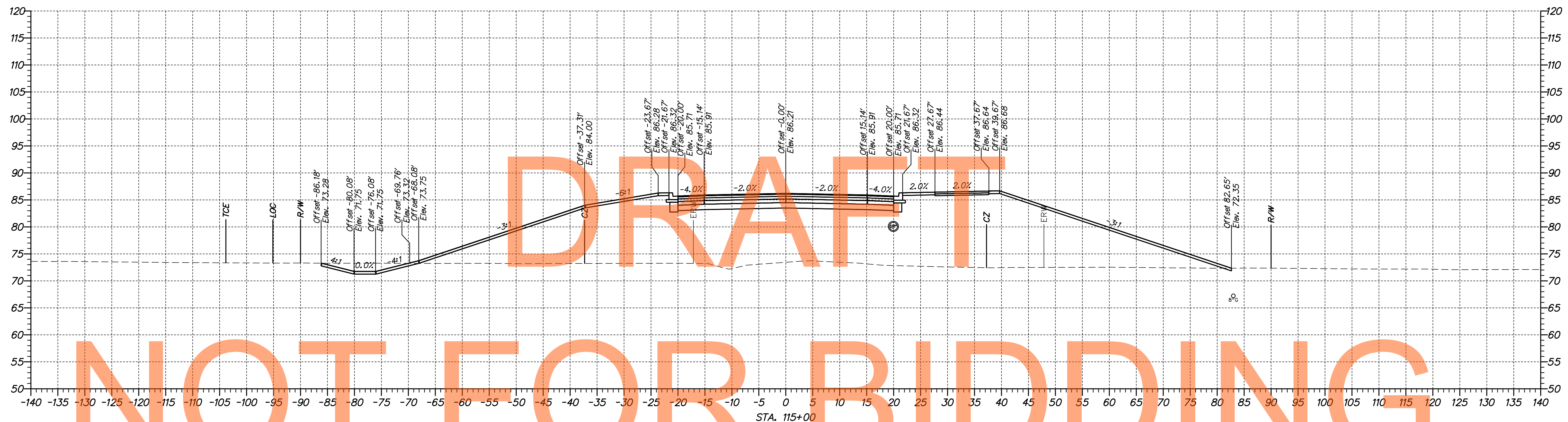

p:\1653-000\contract\1a\cadd\XS002\301_1A_JamisonCorner.dgn
 07/30/2014 10:20:16 AM



ADDENDUMS / REVISIONS	

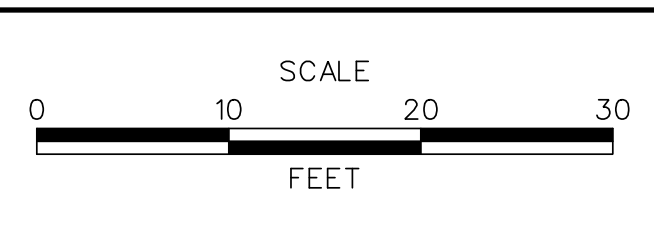

**US 301,
SR 896 TO SR 1**

CONTRACT T200911308	BRIDGE NO.
COUNTY NEW CASTLE	DESIGNED BY: MEF
	CHECKED BY: TAO

**CROSS SECTIONS
JAMISON CORNER ROAD**

SHEET NO. 188
TOTAL SHTS. 337

DRAFT

NOT FOR BIDDING

AUGUST 2015

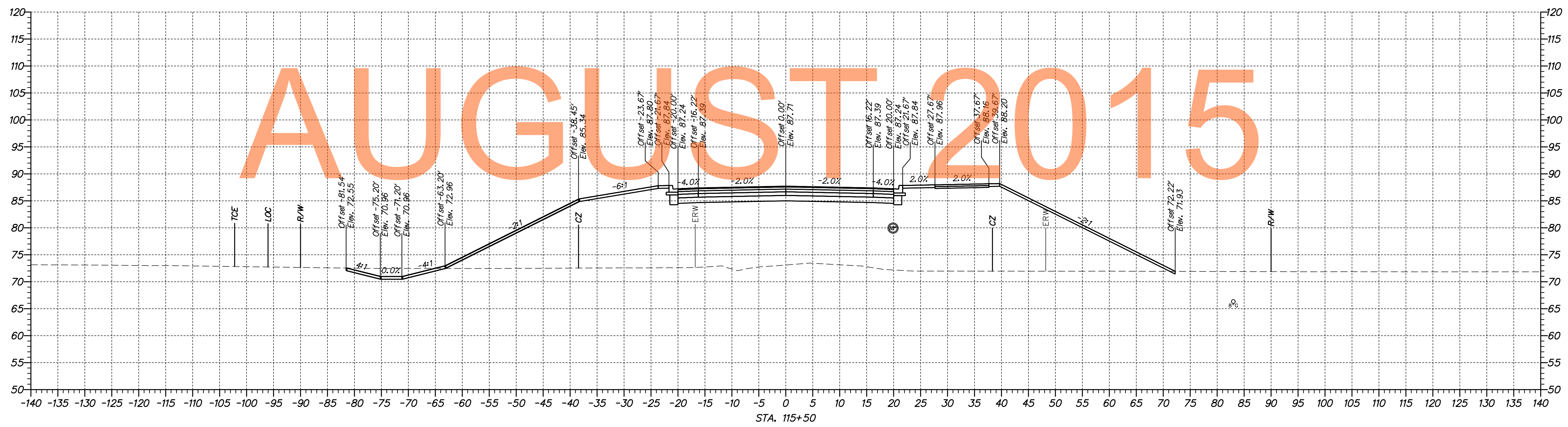
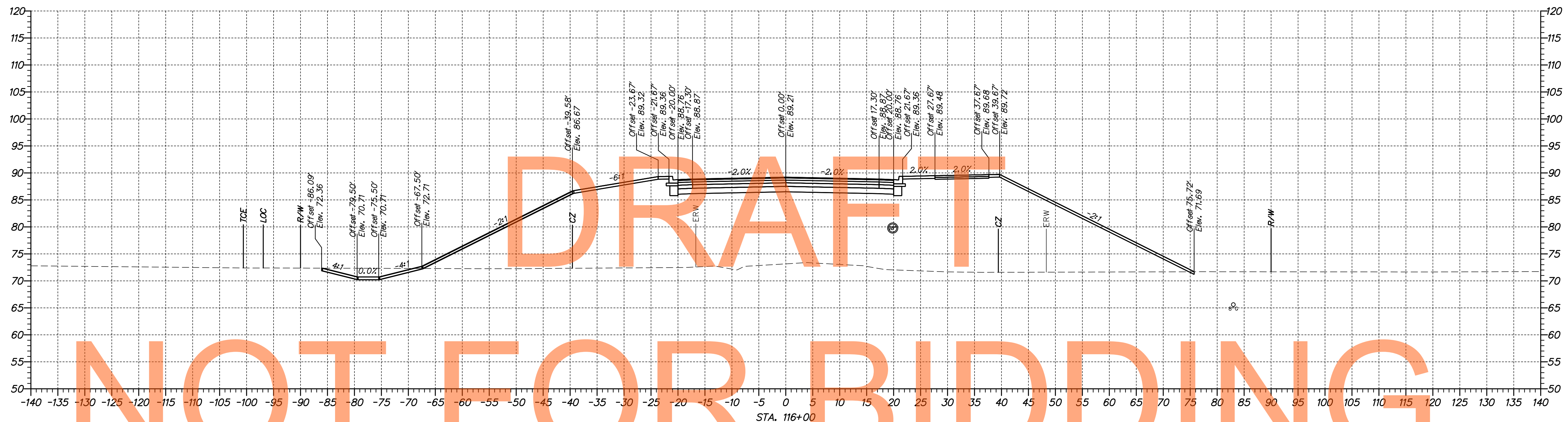

nc:\1653-000\com\refect\p\cead\XS002\301_1A_JamisonCorner.dgn 10/30/2014 10:20:52 AM



ADDENDUMS / REVISIONS	

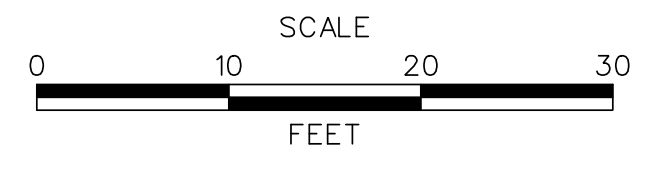

US 301, SR 896 TO SR 1

CONTRACT T200911308	BRIDGE NO.
COUNTY NEW CASTLE	DESIGNED BY: MEF
	CHECKED BY: TAO

CROSS SECTIONS JAMISON CORNER ROAD

SHEET NO. 189
TOTAL SHTS. 337

DRAFT

NOT FOR BIDDING

AUGUST 2015

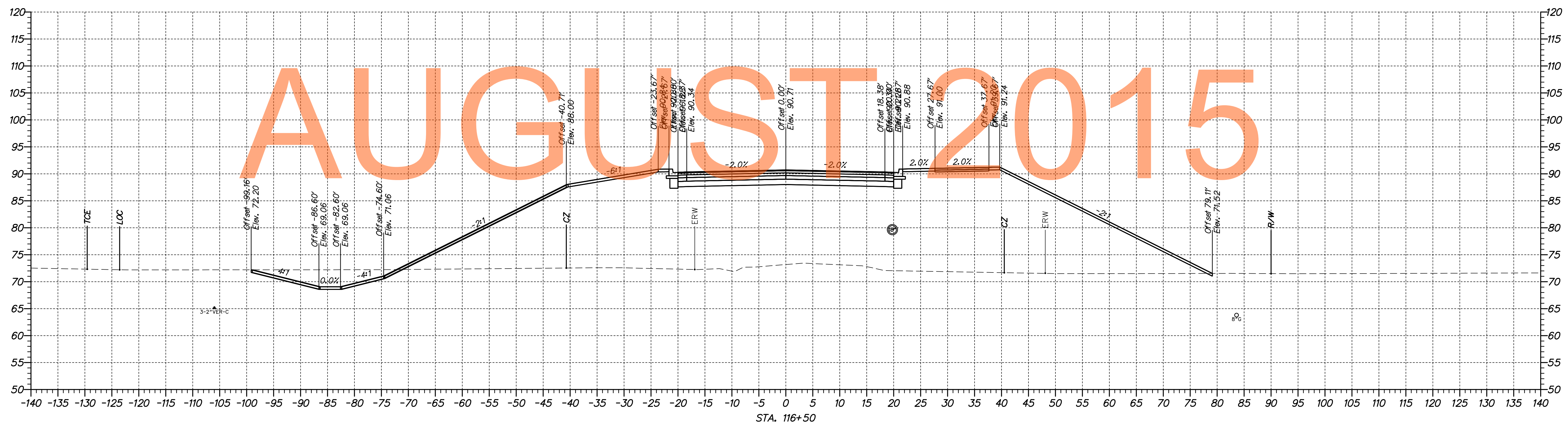
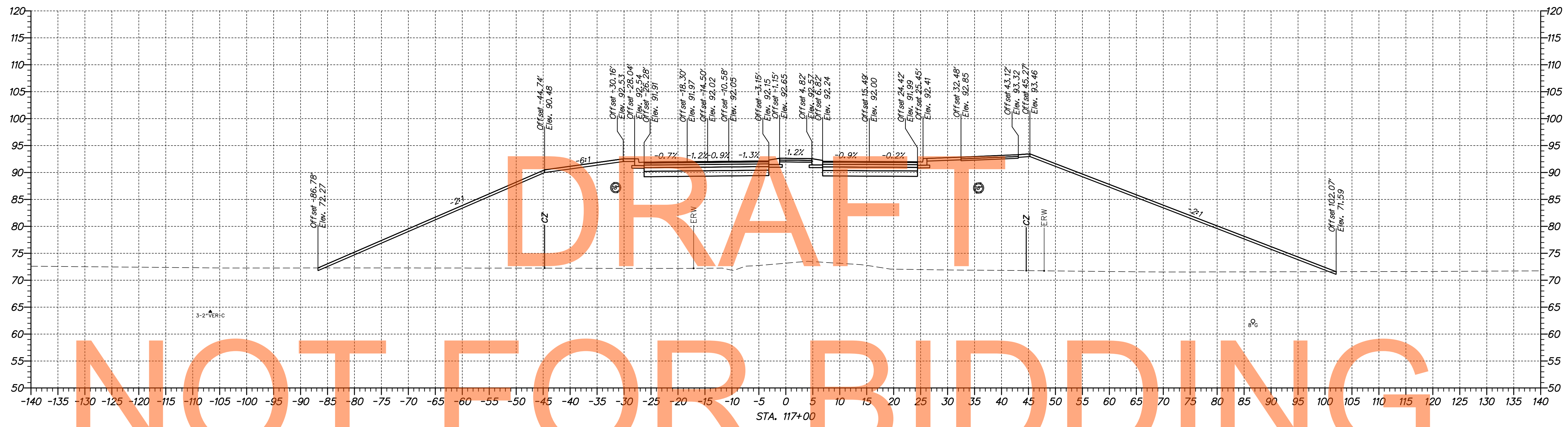

MP:376531-000-Contract:1A-CADD-VS002U301-1A-JamisonCorner.dgn
PL:3/2014 2:12:10 PM



ADDENDUMS / REVISIONS	

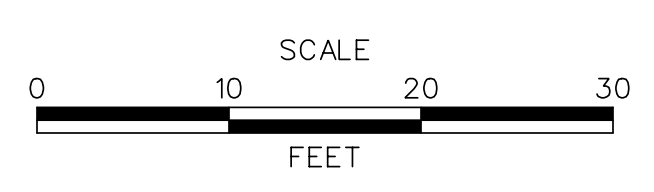

US 301,
SR 896 TO SR 1

CONTRACT	BRIDGE NO.
T200911308	
COUNTY	DESIGNED BY: MEF
NEW CASTLE	CHECKED BY: TAO

CROSS SECTIONS
JAMISON CORNER ROAD

SHEET NO.
190
TOTAL SHTS.
337

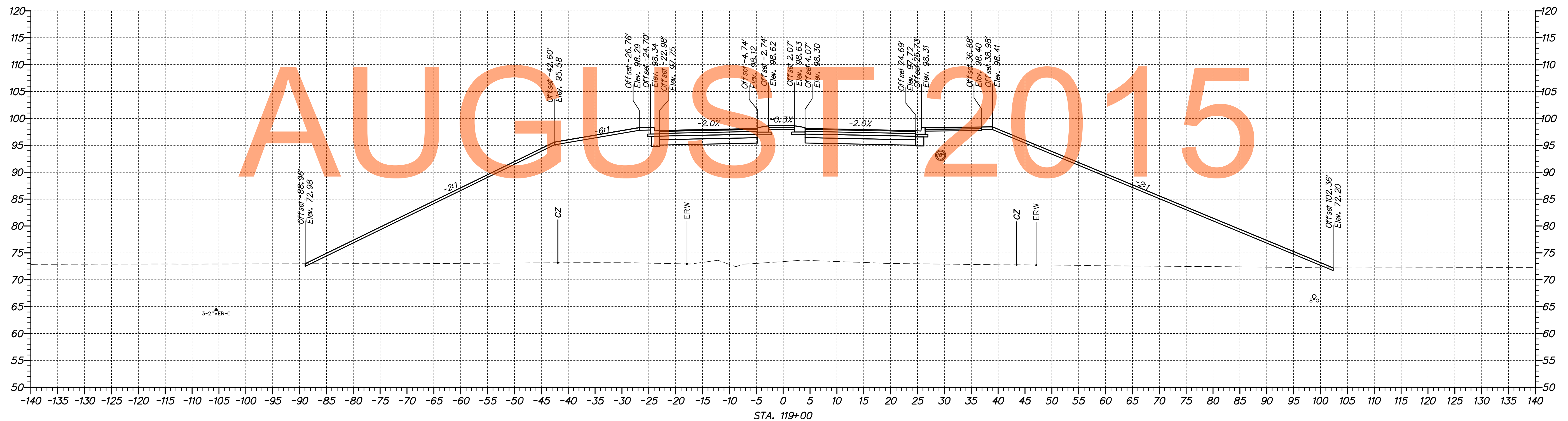
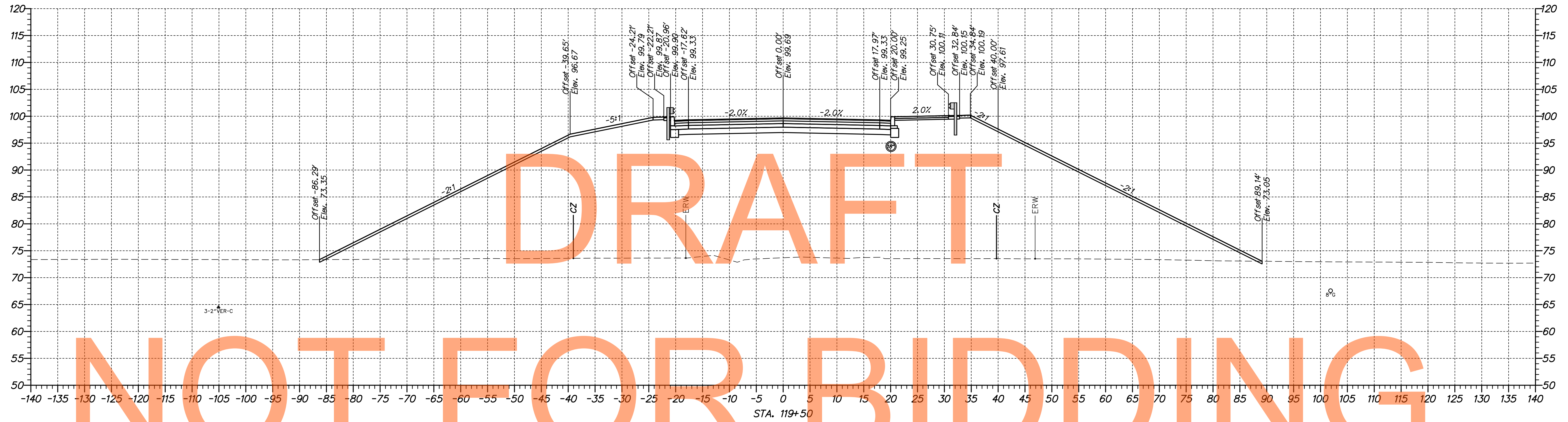

DRAFT

NOT FOR BIDDING

AUGUST 2015

M:\316531-000\Contract 1A\CADD\VS02U301-1A_JamisonCorner.dgn
 11/27/2014 2:10:08 PM



ADDENDUMS / REVISIONS

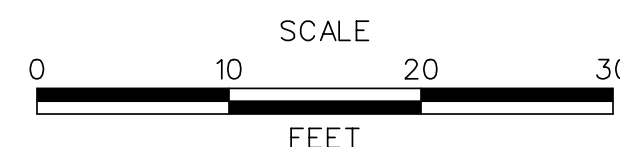

**US 301,
SR 896 TO SR 1**

CONTRACT	BRIDGE NO.
T200911308	DESIGNED BY: MEF
COUNTY	CHECKED BY: TAO
NEW CASTLE	

**CROSS SECTIONS
JAMISON CORNER ROAD**

SHEET NO.
191
TOTAL SHTS.
337

DRAFT

NOT FOR BIDDING

AUGUST 2015

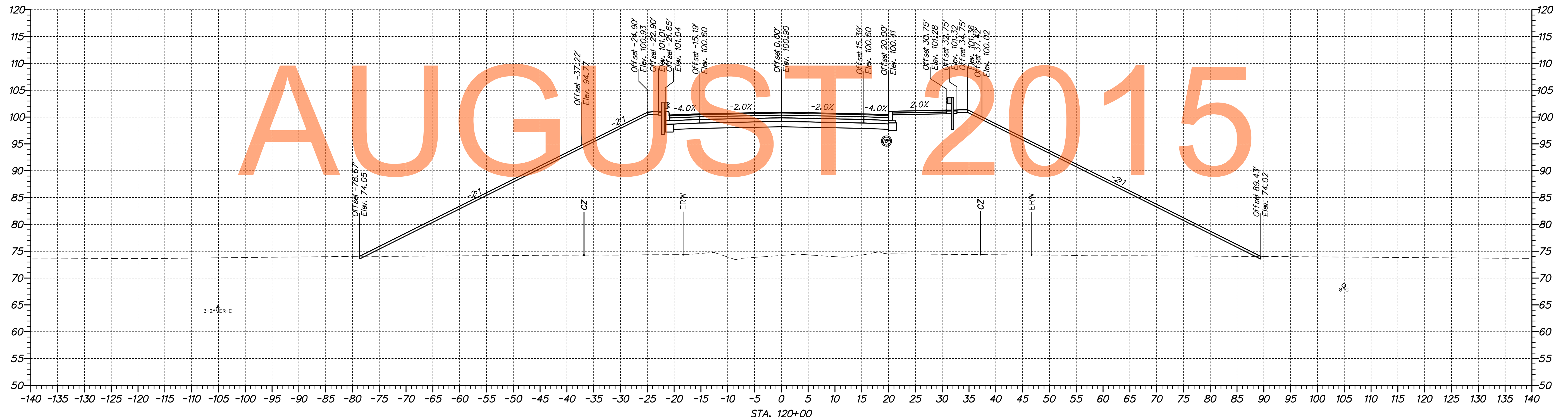
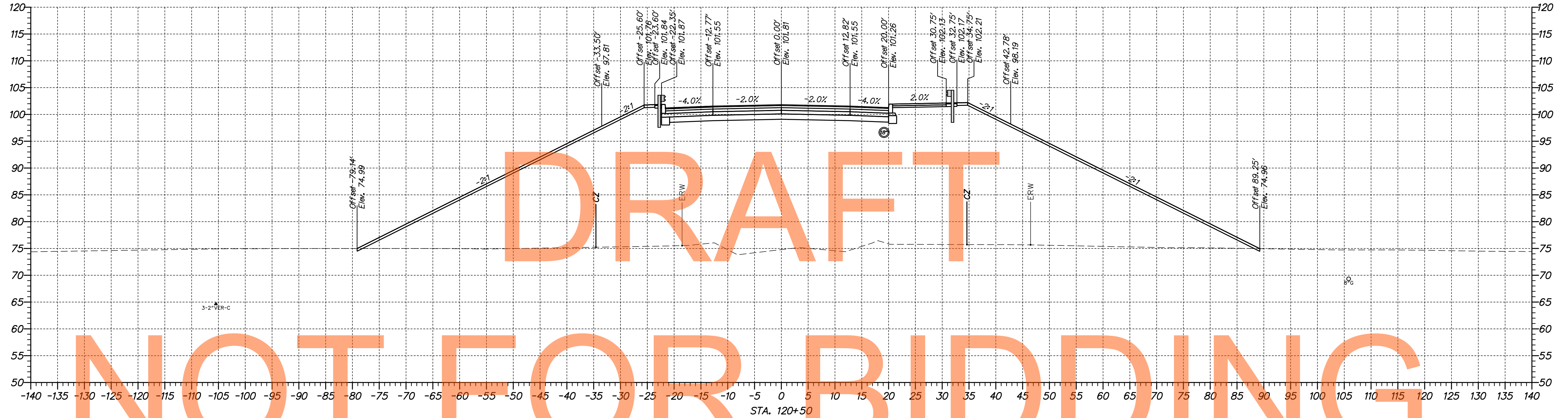

MP_316531_000_VisCont.dwg 1A-CADD_VISO2U301_1A_JamisonCorner.dgn 11/27/2014 2:13:44 PM



ADDENDUMS / REVISIONS

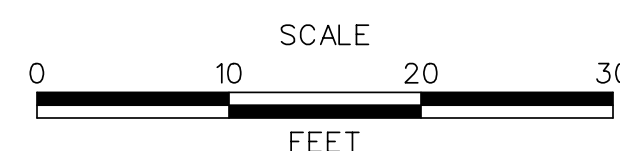

US 301,
SR 896 TO SR 1

CONTRACT	BRIDGE NO.
T200911308	DESIGNED BY: MEF
COUNTY	CHECKED BY: TAO
NEW CASTLE	

CROSS SECTIONS
JAMISON CORNER ROAD

SHEET NO.
192
TOTAL SHTS.
337

DRAFT

NOT FOR BIDDING

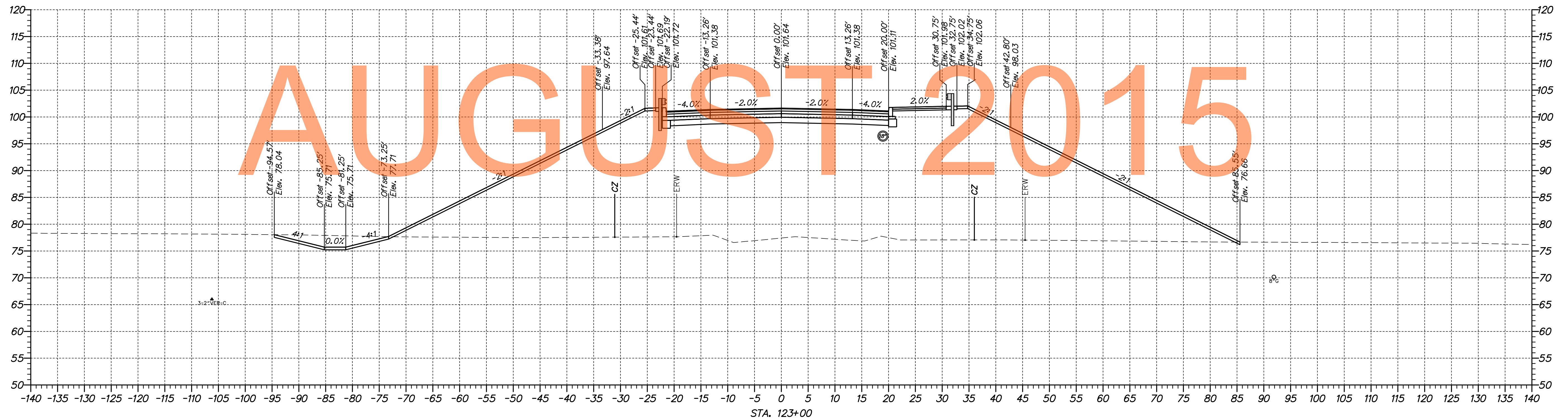
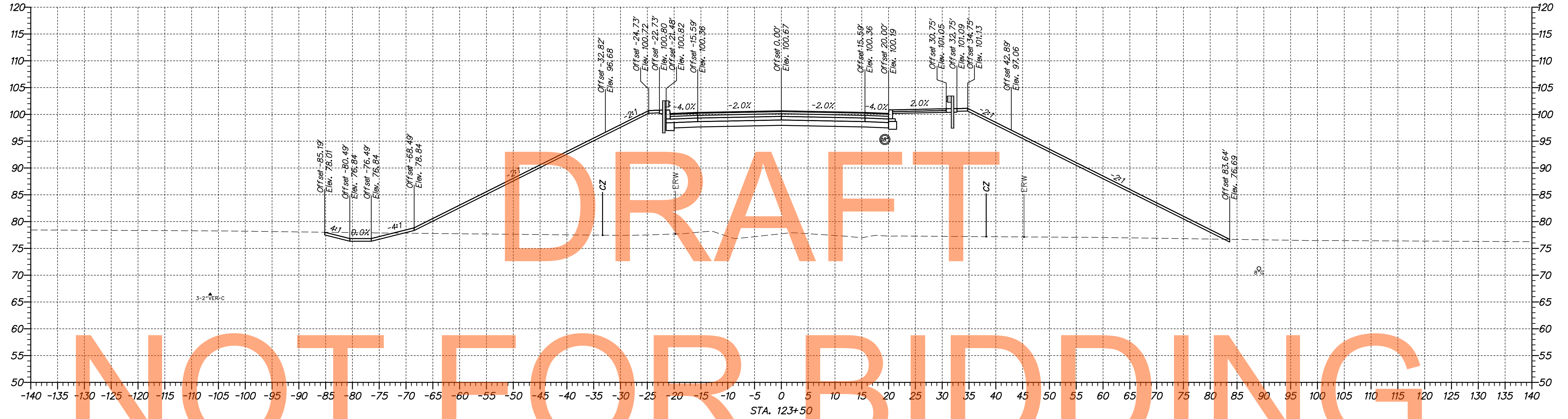

MP_316531_000_VisCont.dwg 1A.CADD.VS02U301_1A_JamisonCorner.dgn 11/27/2014 2:14:27 PM



ADDENDUMS / REVISIONS

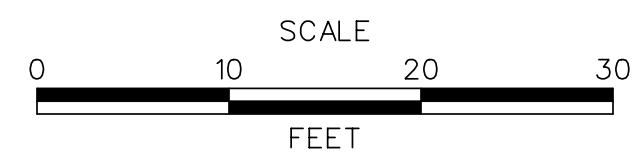

US 301,
SR 896 TO SR 1

CONTRACT	BRIDGE NO.
T200911308	DESIGNED BY: MEF
COUNTY	CHECKED BY: TAO
NEW CASTLE	

CROSS SECTIONS
JAMISON CORNER ROAD

SHEET NO.
193
TOTAL SHTS.
337

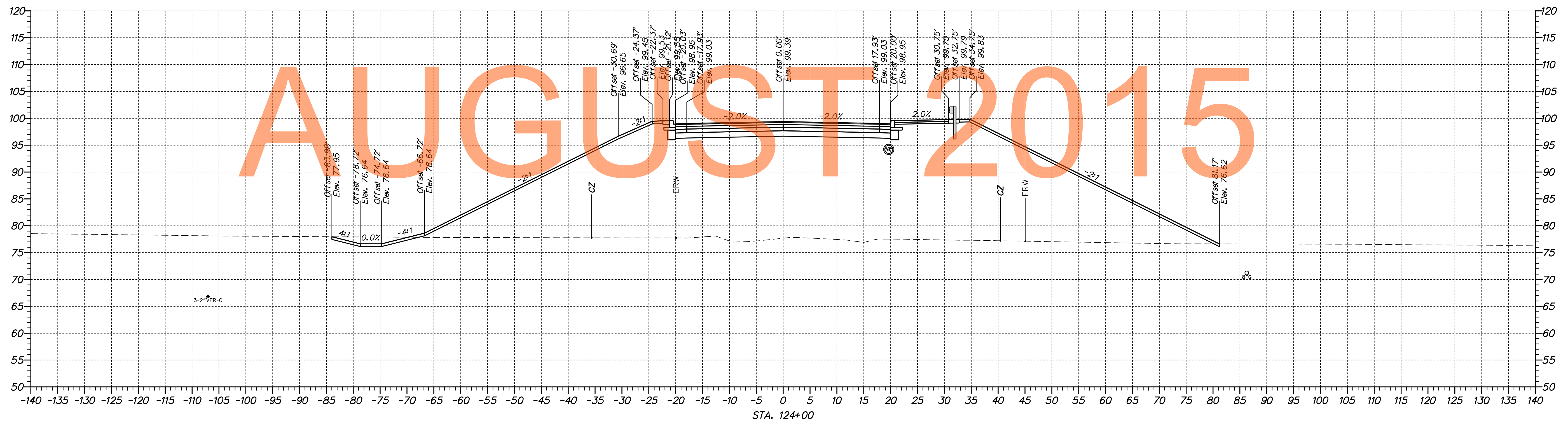
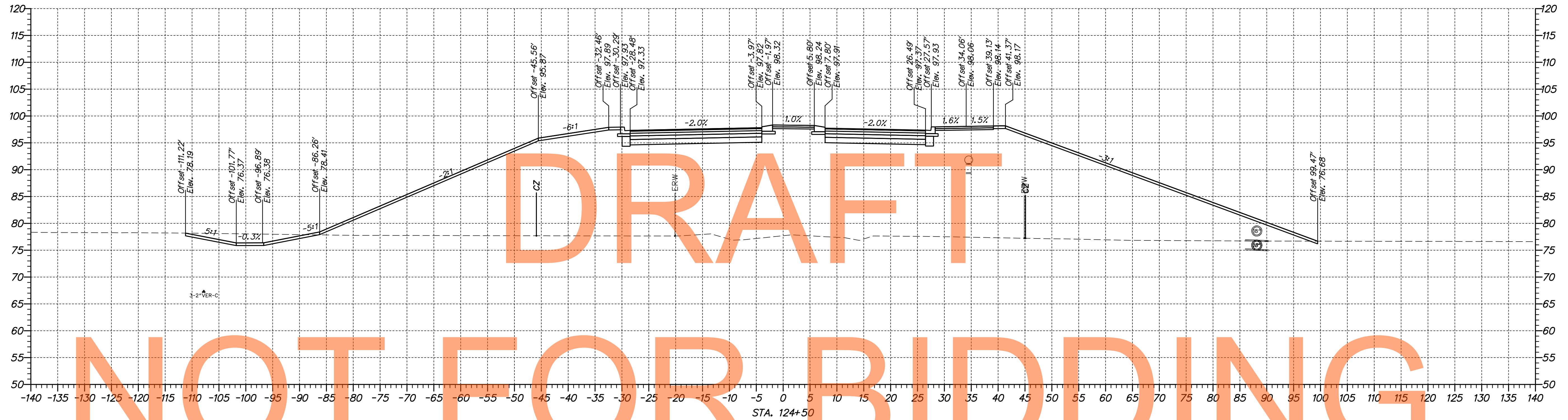

DRAFT

NOT FOR BIDDING

AUGUST 2015

M:\31653\000\Contract\1A\CADD\VS02U301_1A_JamisonCorner.dgn
 11/27/2014 2:21:10 PM



ADDENDUMS / REVISIONS

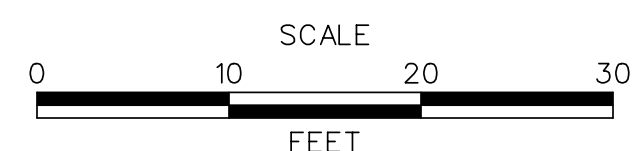

US 301,
SR 896 TO SR 1

CONTRACT	BRIDGE NO.
T200911308	DESIGNED BY: MEF
COUNTY	CHECKED BY: TAO
NEW CASTLE	

CROSS SECTIONS
JAMISON CORNER ROAD

SHEET NO.
194
TOTAL SHTS.
337

DRAFT

NOT FOR BIDDING

AUGUST 2015

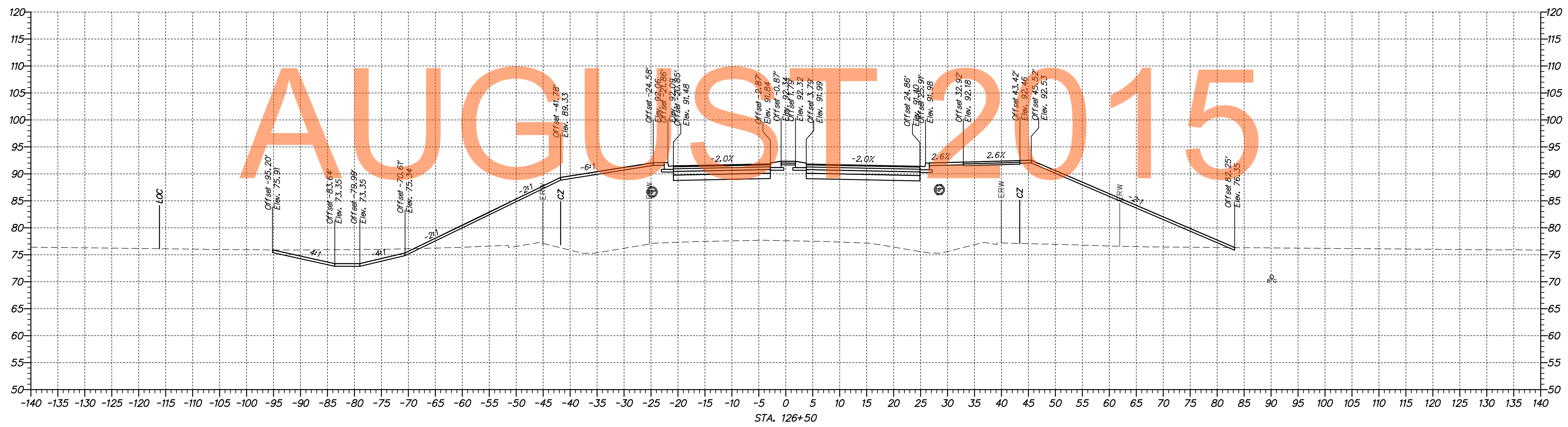
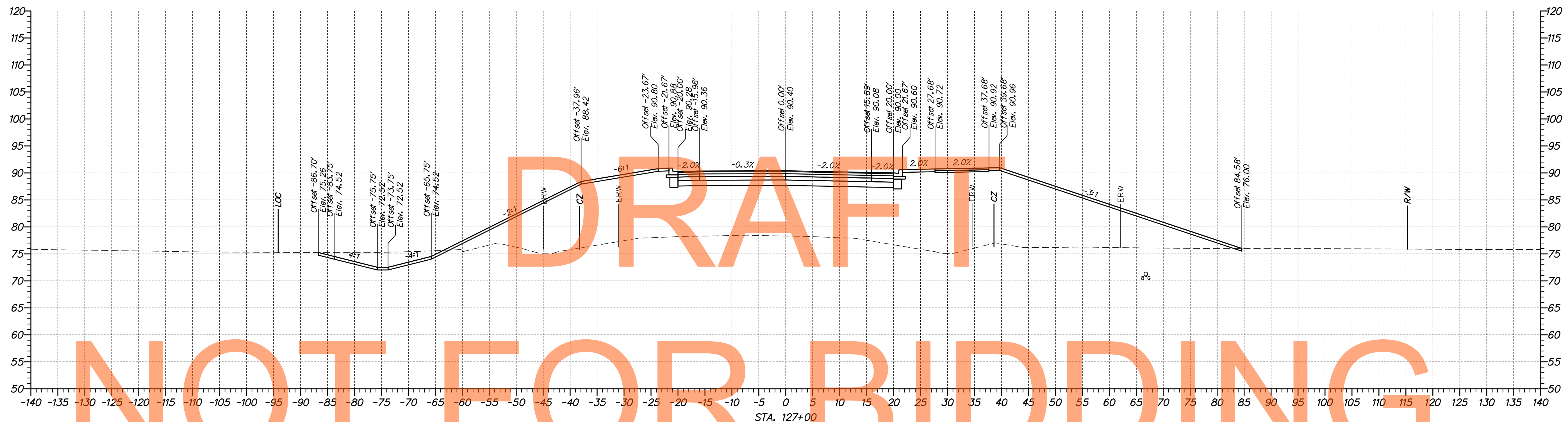

nc:\653-000\con\ref\p\cead\XS002\301_1A_JamisonCorner.dgn 10/30/2014 10:20:53 AM



ADDENDUMS / REVISIONS	

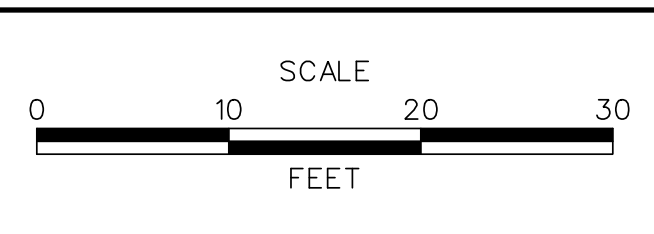

**US 301,
SR 896 TO SR 1**

CONTRACT T200911308	BRIDGE NO.
COUNTY NEW CASTLE	DESIGNED BY: MEF
	CHECKED BY: TAO

**CROSS SECTIONS
JAMISON CORNER ROAD**

SHEET NO. 195
TOTAL SHTS. 337

DRAFT

NOT FOR BIDDING

AUGUST 2015

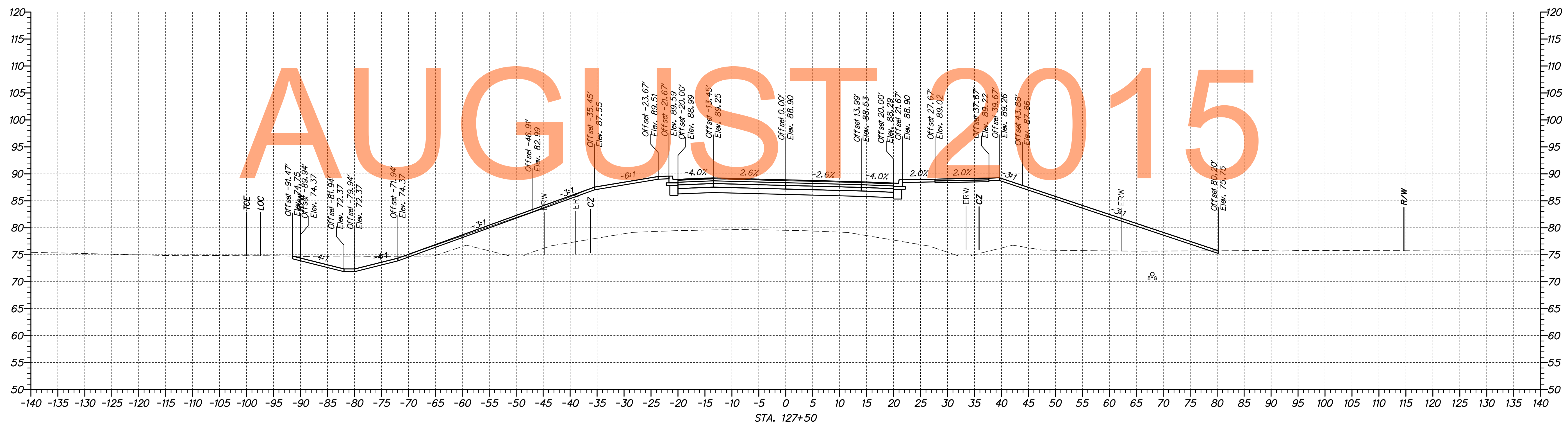
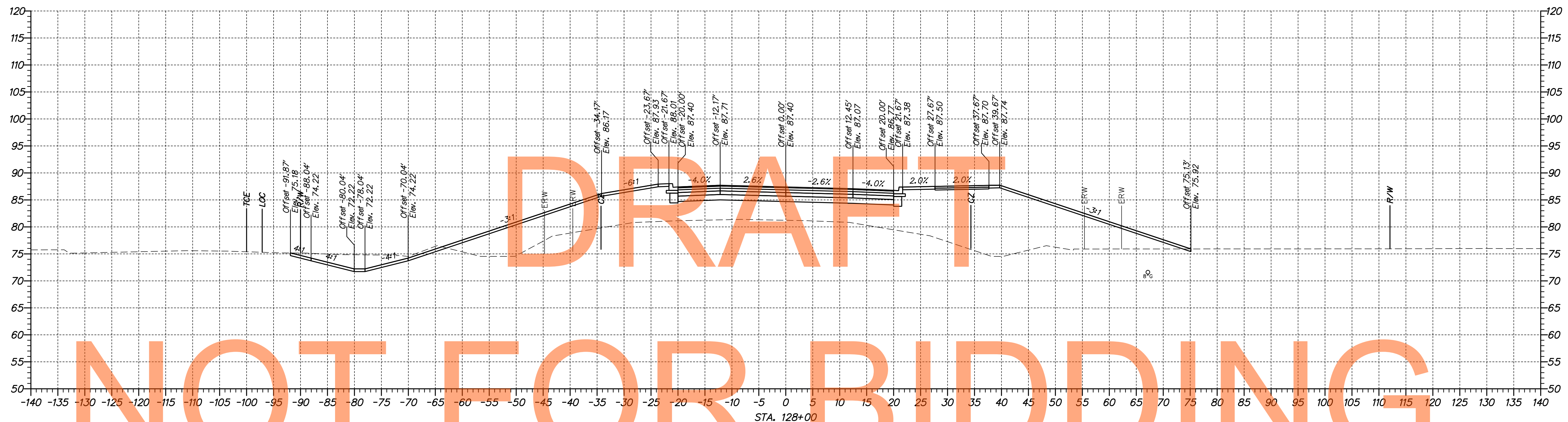

\\1653-000\cadd\project\1a\cadd\XS002\301_1A_JamisonCorner.dgn 10/30/2014 10:20:53 AM



ADDENDUMS / REVISIONS	

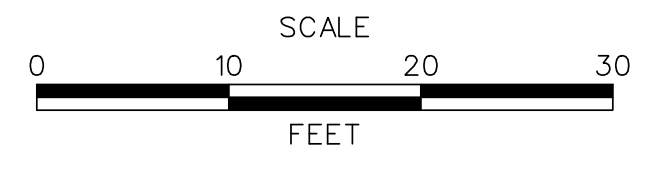

US 301,
SR 896 TO SR 1

CONTRACT	BRIDGE NO.
T200911308	
COUNTY	DESIGNED BY: MEF
NEW CASTLE	CHECKED BY: TAO

CROSS SECTIONS
JAMISON CORNER ROAD

SHEET NO.
196
TOTAL SHTS.
337

n:\1653-000\con\proj\1a\cadd\XS002\301_1A_JamisonCorner.dgn
 08/30/2014 10:20:57 AM

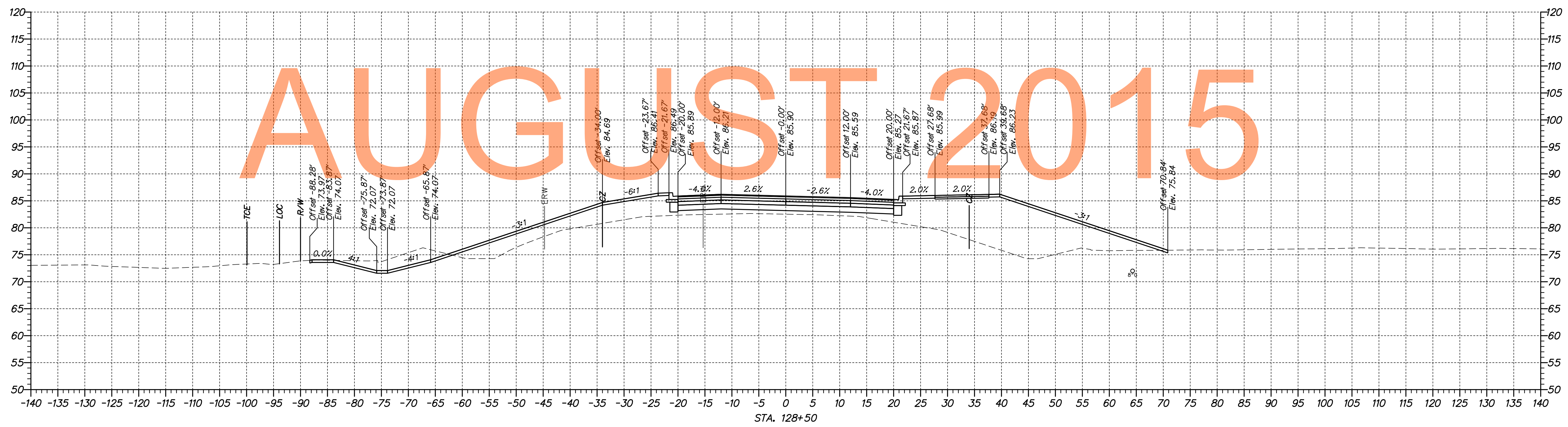
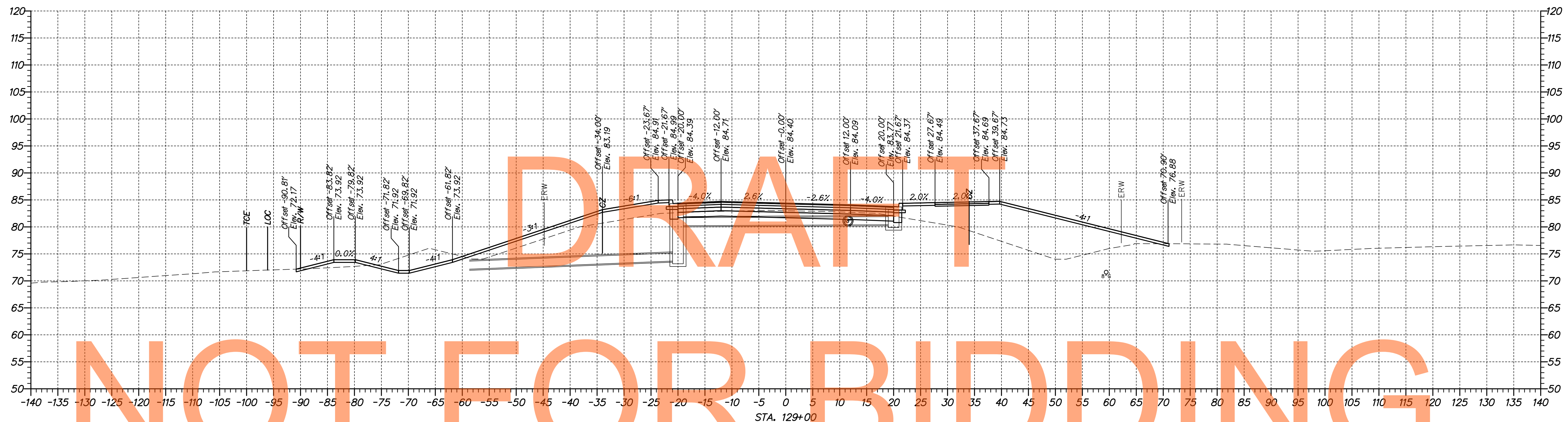

DRAFT

NOT FOR BIDDING

AUGUST 2015



ADDENDUMS / REVISIONS	

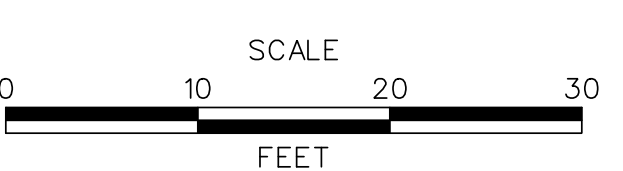

**US 301,
SR 896 TO SR 1**

CONTRACT	BRIDGE NO.
T200911308	DESIGNED BY: MEF
COUNTY	CHECKED BY: TAO
NEW CASTLE	

**CROSS SECTIONS
JAMISON CORNER ROAD**

SHEET NO.
197
TOTAL SHTS.
337

DRAFT

NOT FOR BIDDING

AUGUST 2015

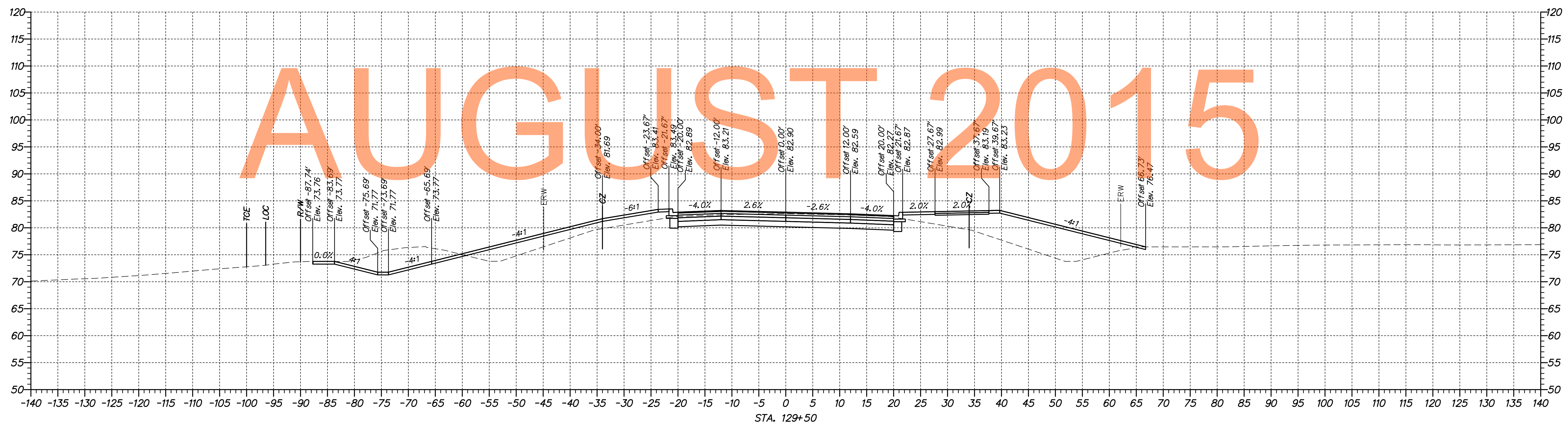
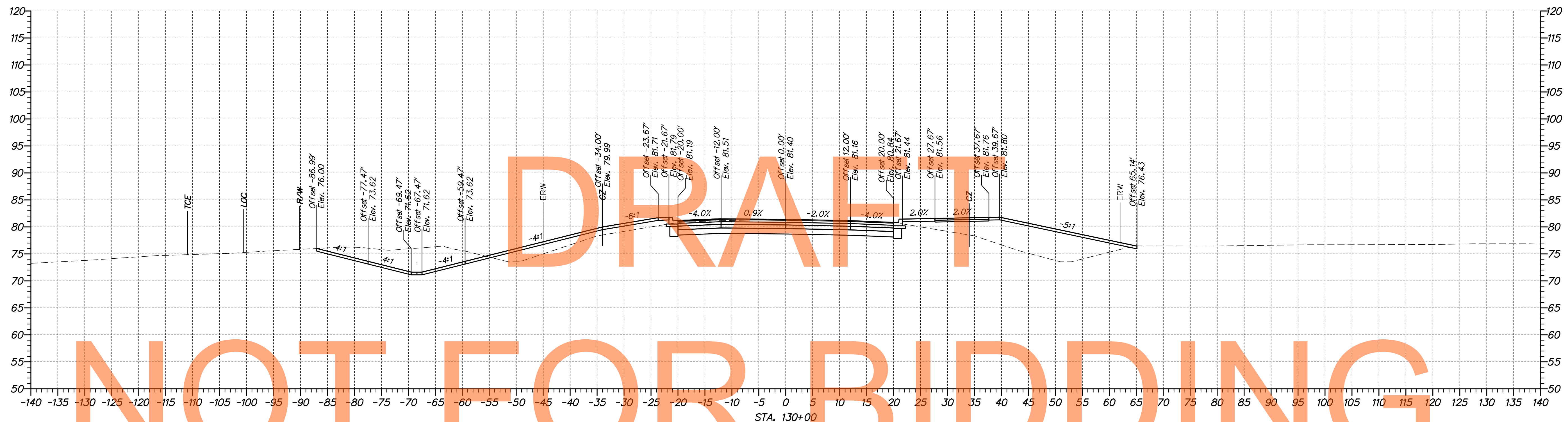

\\1653-000\con\trac\1a\cadd\X5002\301_1A_JamisonCorner.dgn 10/20/2014 10:20:59 AM



ADDENDUMS / REVISIONS	

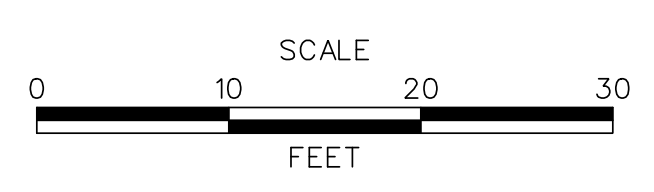

US 301, SR 896 TO SR 1

CONTRACT	BRIDGE NO.
T200911308	DESIGNED BY: MEF
COUNTY	CHECKED BY: TAO
NEW CASTLE	

CROSS SECTIONS JAMISON CORNER ROAD

SHEET NO.
198
TOTAL SHTS.
337

NOT FOR BIDDING

AUGUST 2015

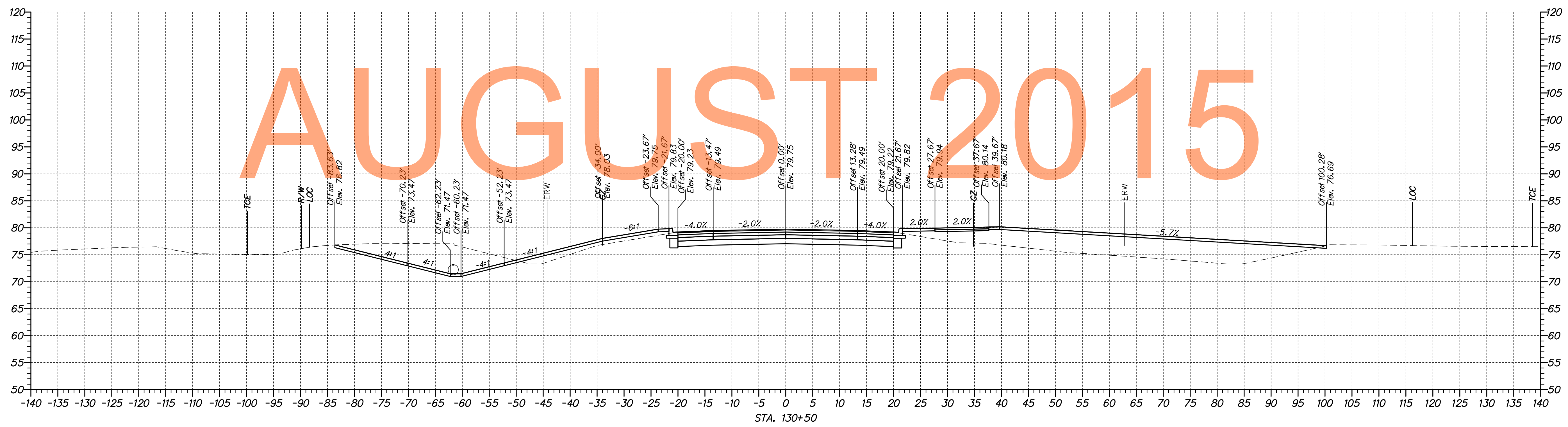
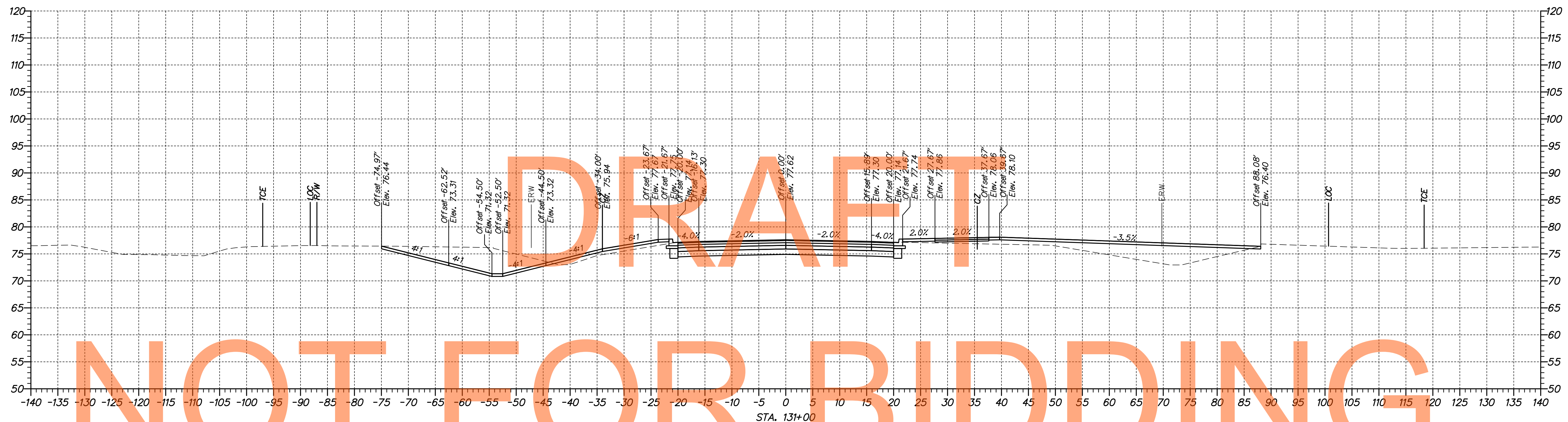

p:\1653-000\contract\1a\cadd\XS002\1301_1A_JamisonCorner.dgn
 08/30/2014 10:20:44 AM



ADDENDUMS / REVISIONS	

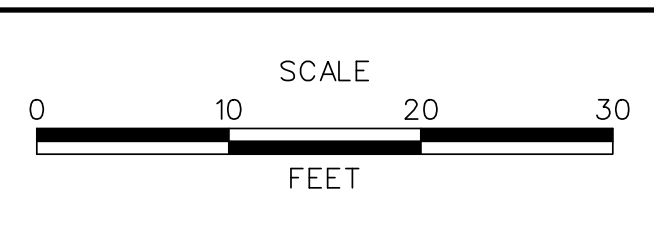

US 301,
SR 896 TO SR 1

CONTRACT	BRIDGE NO.
T200911308	DESIGNED BY: MEF
COUNTY	CHECKED BY: TAO
NEW CASTLE	

**CROSS SECTIONS
JAMISON CORNER ROAD**

SHEET NO.	199
TOTAL SHTS.	337

DRAFT

NOT FOR BIDDING

AUGUST 2015

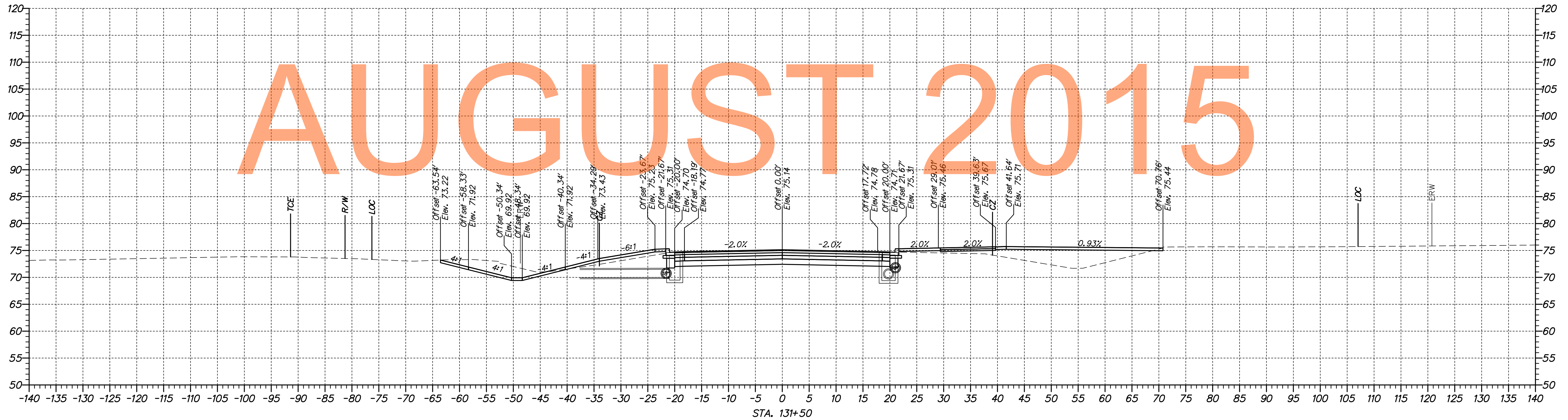
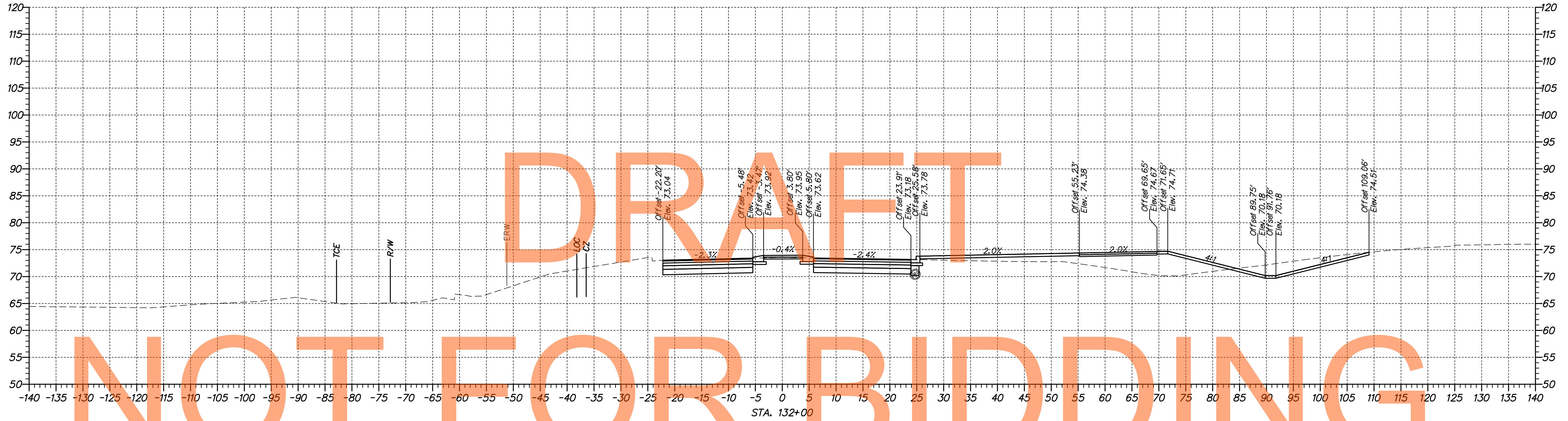

\\03653-000\con\proj\delaware\2014\10\2014_08\131-132\131-132.dgn



ADDENDUMS / REVISIONS

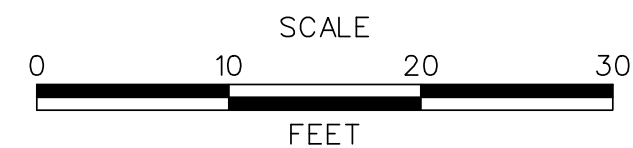

US 301,
SR 896 TO SR 1

CONTRACT	BRIDGE NO.
T200911308	DESIGNED BY: MEF
COUNTY	CHECKED BY: TAO
NEW CASTLE	

CROSS SECTIONS
JAMISON CORNER ROAD

SHEET NO.
200
TOTAL SHTS.
337