

DRAFT

NOT FOR BIDDING

AUGUST 2015

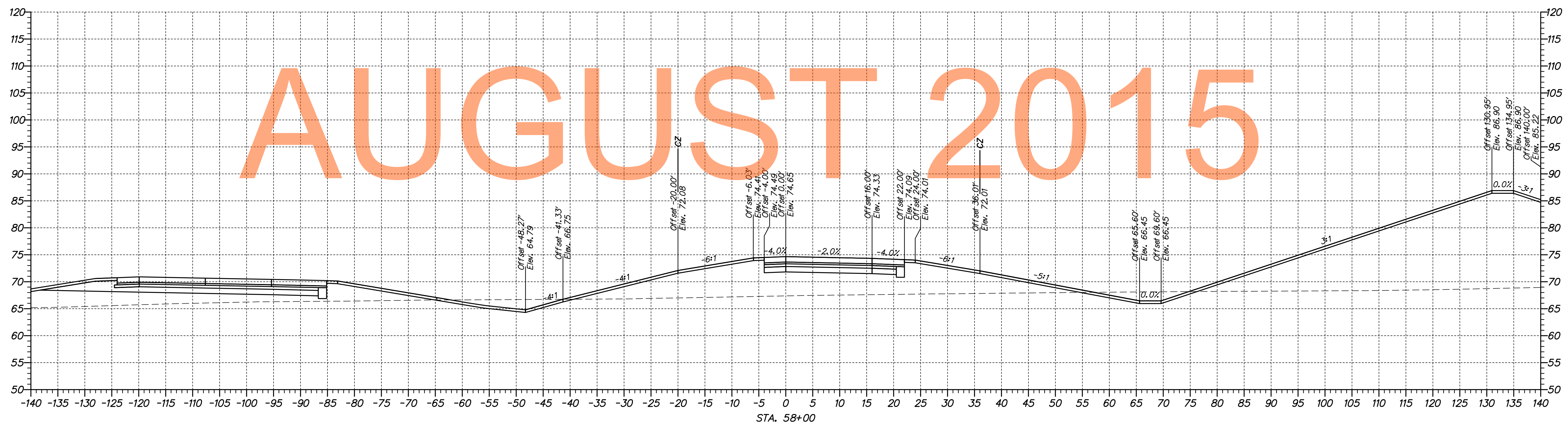
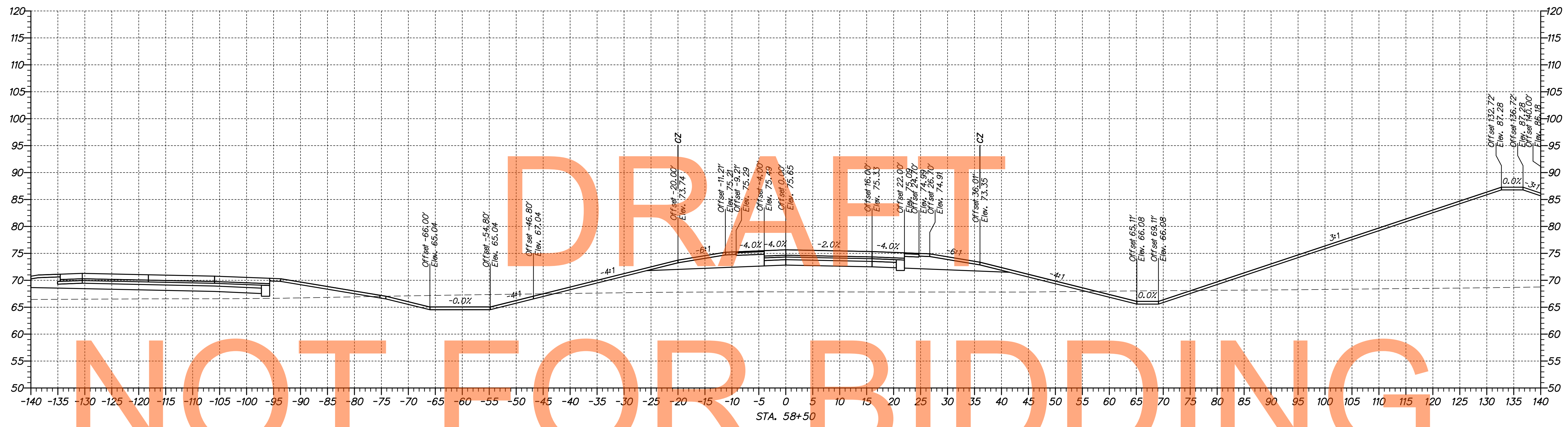

\\0653-000\con\refect\p\cadd\US301-IA\_Ramp\_P\_AET\_Sections\BFT.dgn 10/30/2014 10:22:22 AM



ADDENDUMS / REVISIONS	

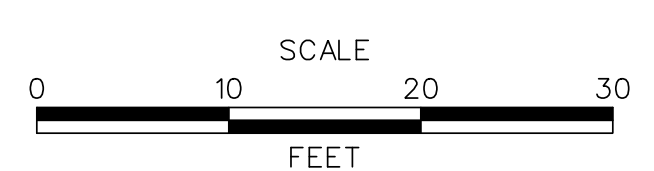

US 301, SR 896 TO SR 1

CONTRACT T200911308	BRIDGE NO.
COUNTY NEW CASTLE	DESIGNED BY: MEF
	CHECKED BY: TAO

CROSS SECTIONS RAMP P

SHEET NO. 251
TOTAL SHTS. 337

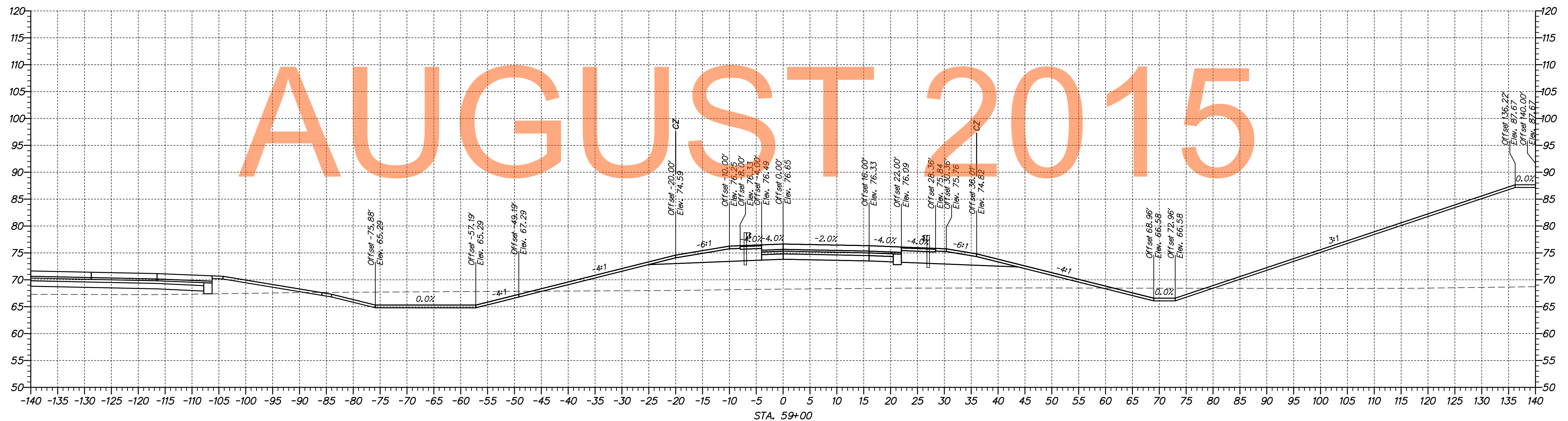
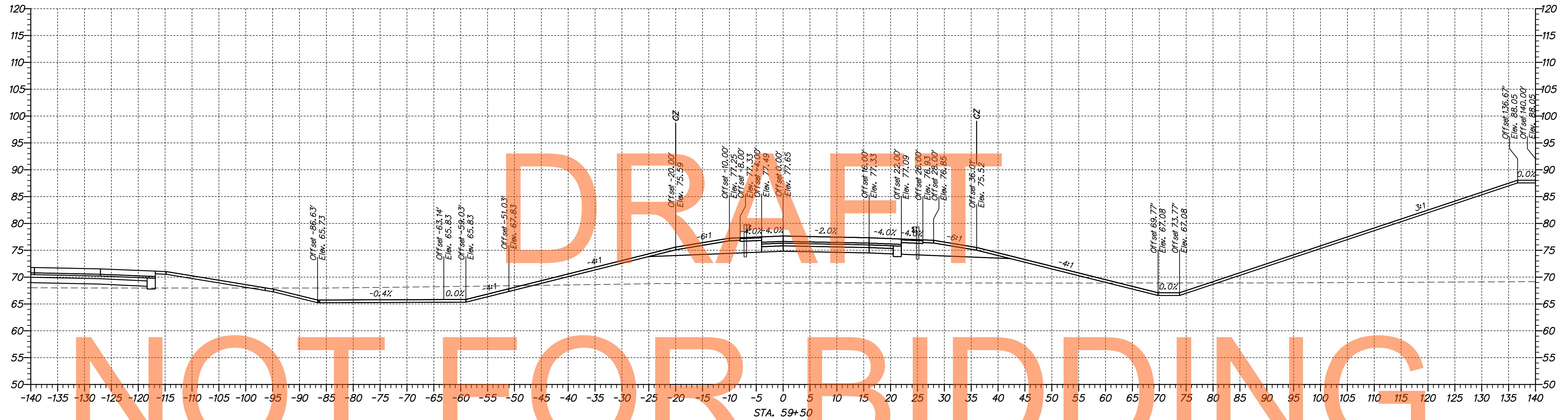

DRAFT

NOT FOR BIDDING

AUGUST 2015

p:\1653-000\contract\p\cadd\US301-IA\_Ramp\_P\_AET\_Sections\BFT.dgn  
 08/30/2014 10:22:24 AM



ADDENDUMS / REVISIONS	

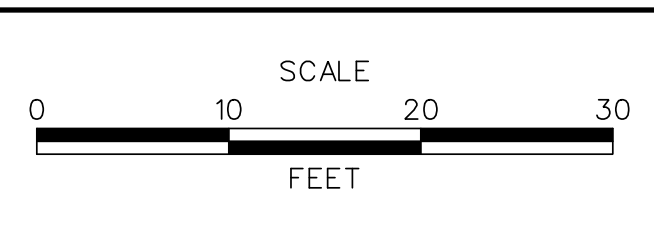

**US 301,  
SR 896 TO SR 1**

CONTRACT T200911308	BRIDGE NO.
COUNTY NEW CASTLE	DESIGNED BY: MEF
	CHECKED BY: TAO

<b>CROSS SECTIONS RAMP P</b>	SHEET NO. 252
	TOTAL SHTS. 337

DRAFT

NOT FOR BIDDING

AUGUST 2015

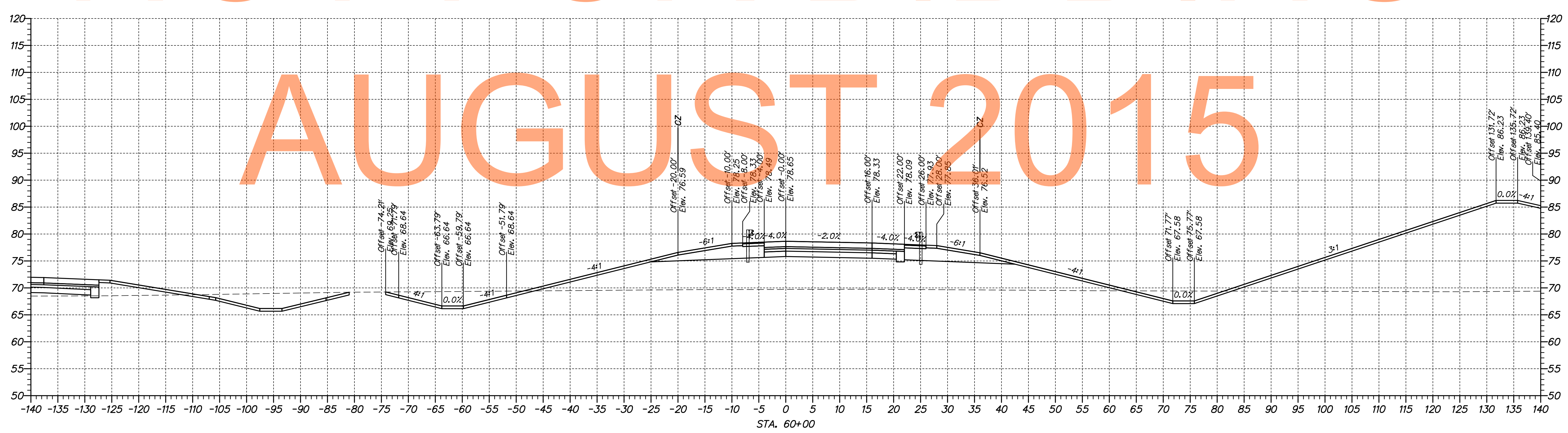
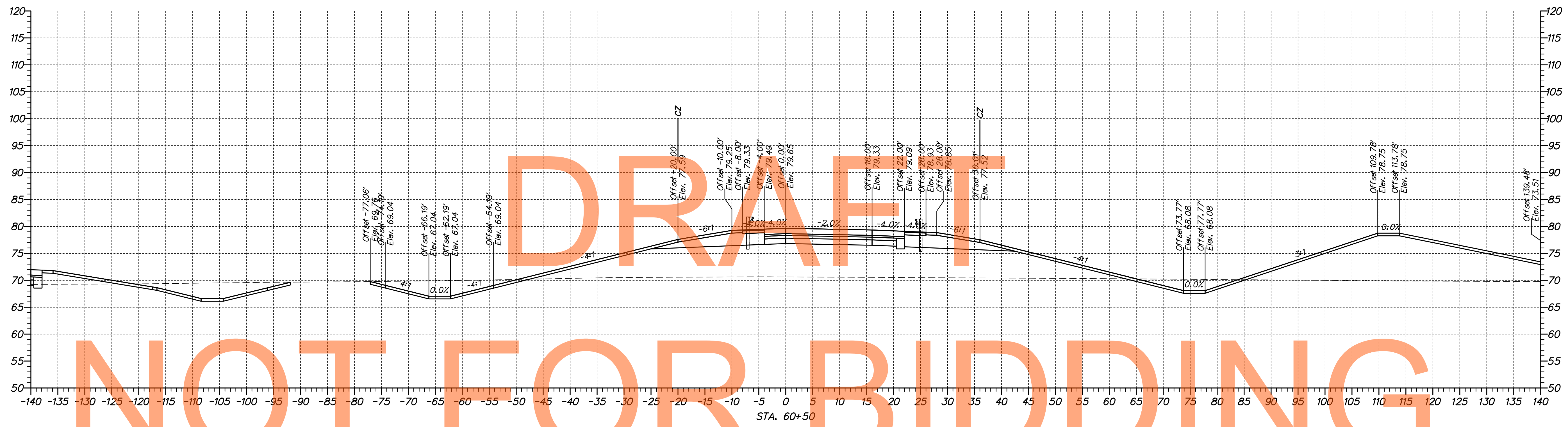

\\03653-000\contract\1a\cadd\US301\A\_Ramp\_P\_AET\_Sections\BFT.dgn 10/30/2014 10:22:28 AM



ADDENDUMS / REVISIONS	

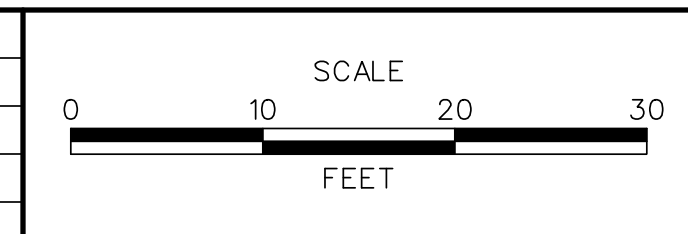

US 301,  
SR 896 TO SR 1

CONTRACT	BRIDGE NO.
T200911308	DESIGNED BY: MEF
COUNTY	CHECKED BY: TAO
NEW CASTLE	

CROSS SECTIONS  
RAMP P

SHEET NO.
253
TOTAL SHTS.
337

DRAFT

NOT FOR BIDDING

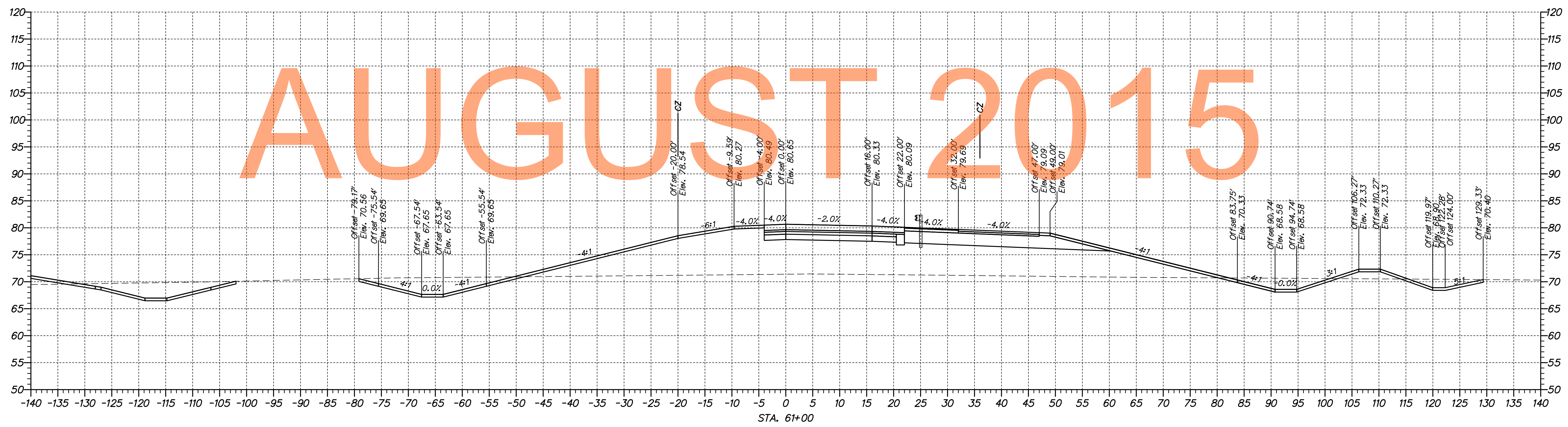
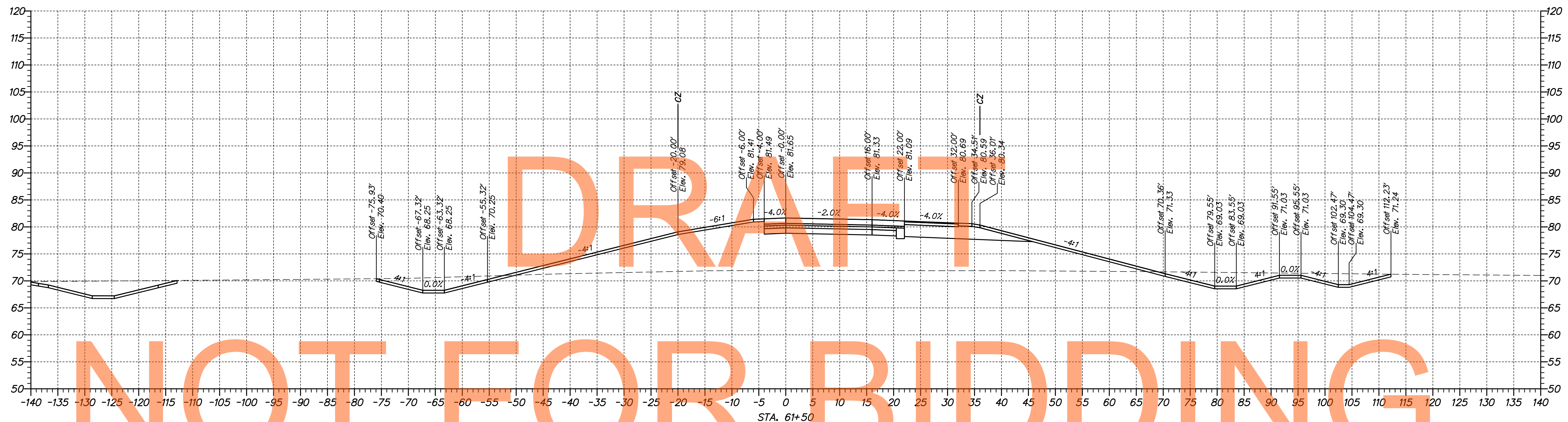

n:\1653-000\contract\1a\cadd\US301-1A\_Ramp\_P\_AET\_SectionsBFT.dgn  
 10/30/2014 10:22:28 AM



ADDENDUMS / REVISIONS	

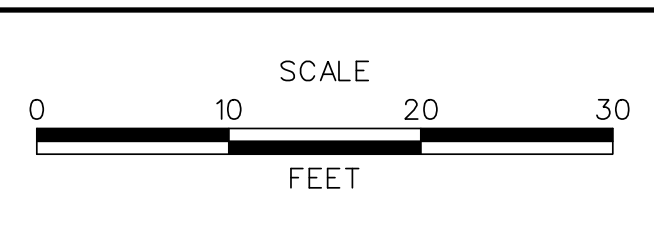

**US 301,  
SR 896 TO SR 1**

CONTRACT	BRIDGE NO.
T200911308	
COUNTY	DESIGNED BY: MEF
NEW CASTLE	CHECKED BY: TAO

<b>CROSS SECTIONS RAMP P</b>	SHEET NO.
	254
	TOTAL SHTS.
	337

DRAFT

NOT FOR BIDDING

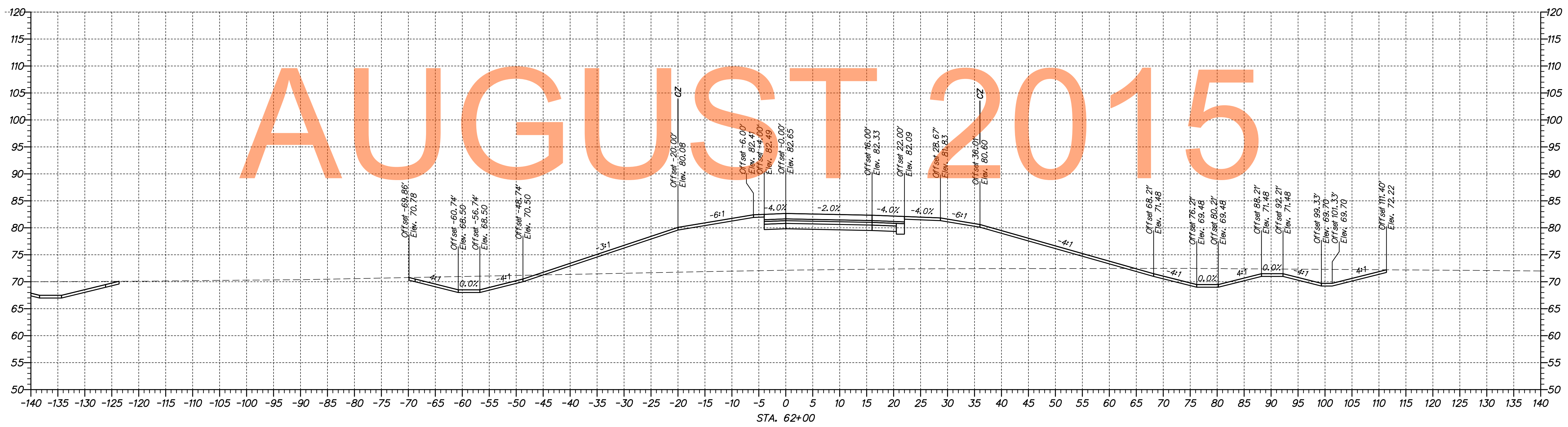
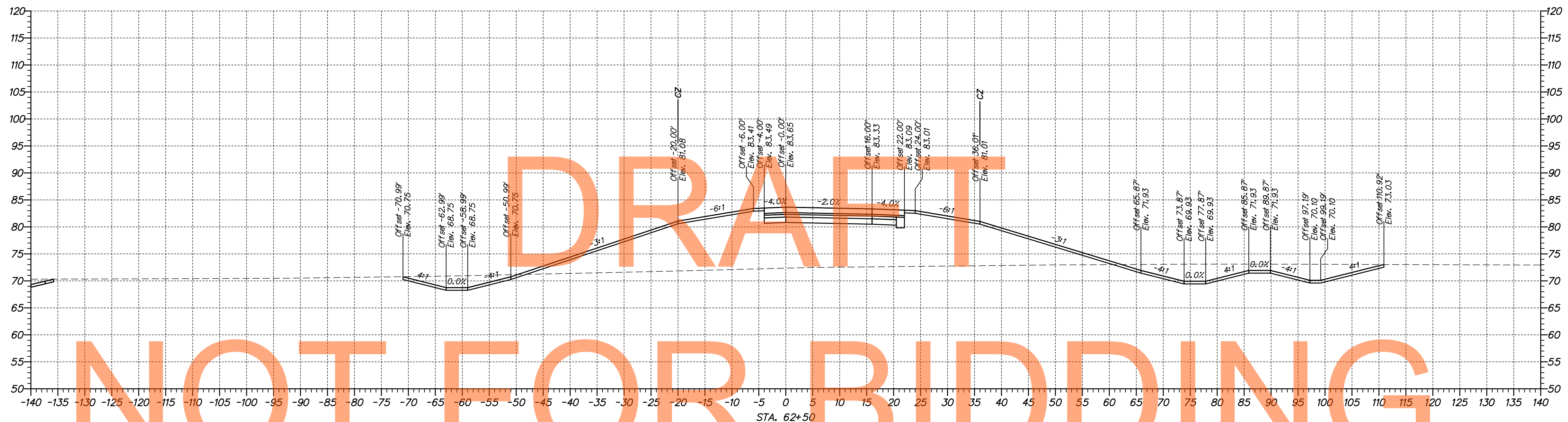

p:\1653-000\con\trac\1a\cadd\US301-1A\_Ramp\_P\_AET\_SectionsBFT.dgn  
 08/30/2014 10:22:50 AM



ADDENDUMS / REVISIONS	

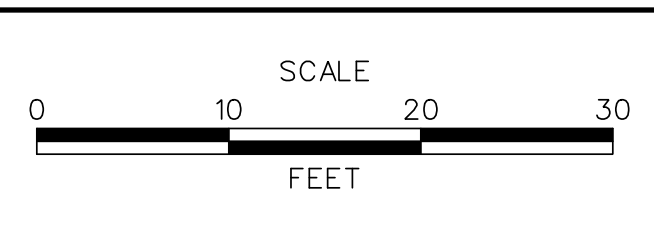

**US 301,  
SR 896 TO SR 1**

CONTRACT	BRIDGE NO.
T200911308	
COUNTY	DESIGNED BY: MEF
NEW CASTLE	CHECKED BY: TAO

<b>CROSS SECTIONS RAMP P</b>	SHEET NO.
	255
	TOTAL SHTS.
	337

DRAFT

NOT FOR BIDDING

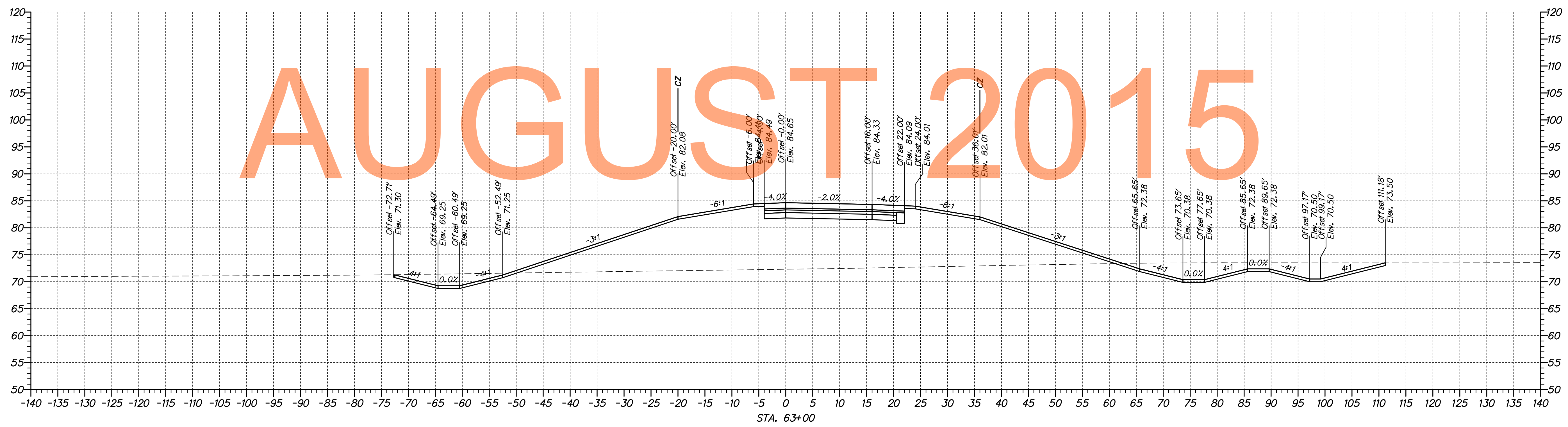
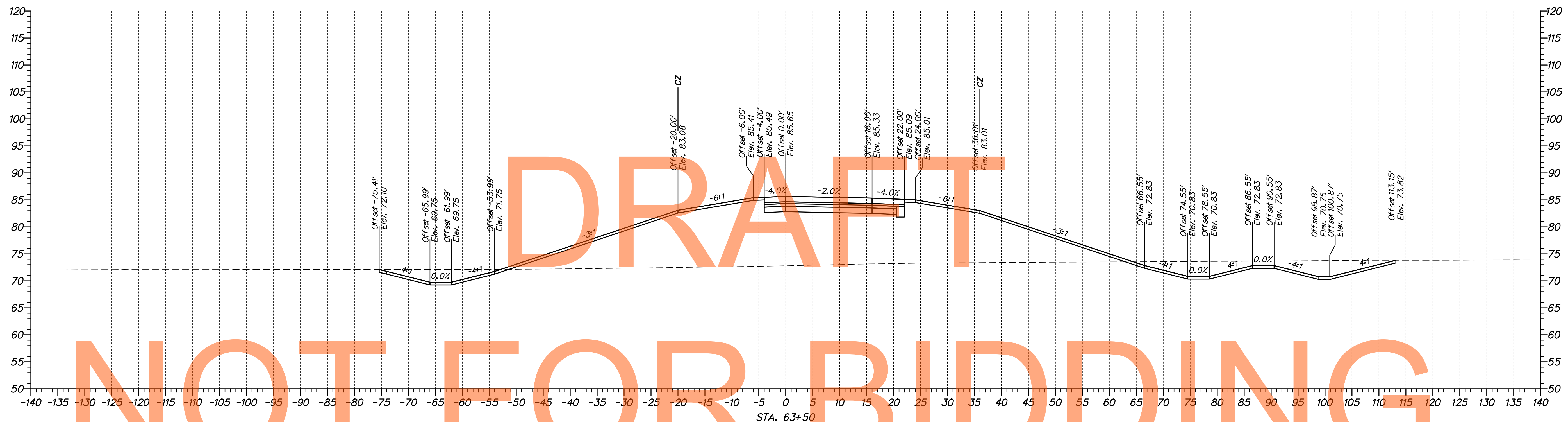

p:\1653-000\con\ref\1a\cadd\US301\_1A\_Ramp\_P\_AET\_Sections\BFT.dgn  
 08/30/2014 10:22:53 AM



ADDENDUMS / REVISIONS	

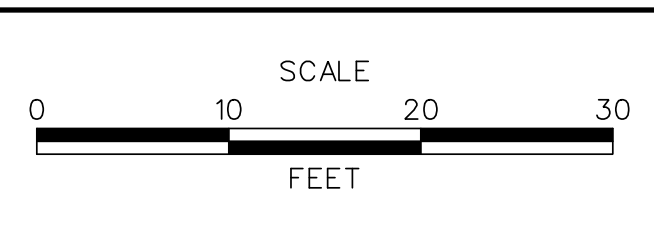

**US 301,  
SR 896 TO SR 1**

CONTRACT	BRIDGE NO.
T200911308	
COUNTY	DESIGNED BY: MEF
NEW CASTLE	CHECKED BY: TAO

<b>CROSS SECTIONS RAMP P</b>	SHEET NO.
	256
<b>CROSS SECTIONS RAMP P</b>	TOTAL SHTS.
	337

DRAFT

NOT FOR BIDDING

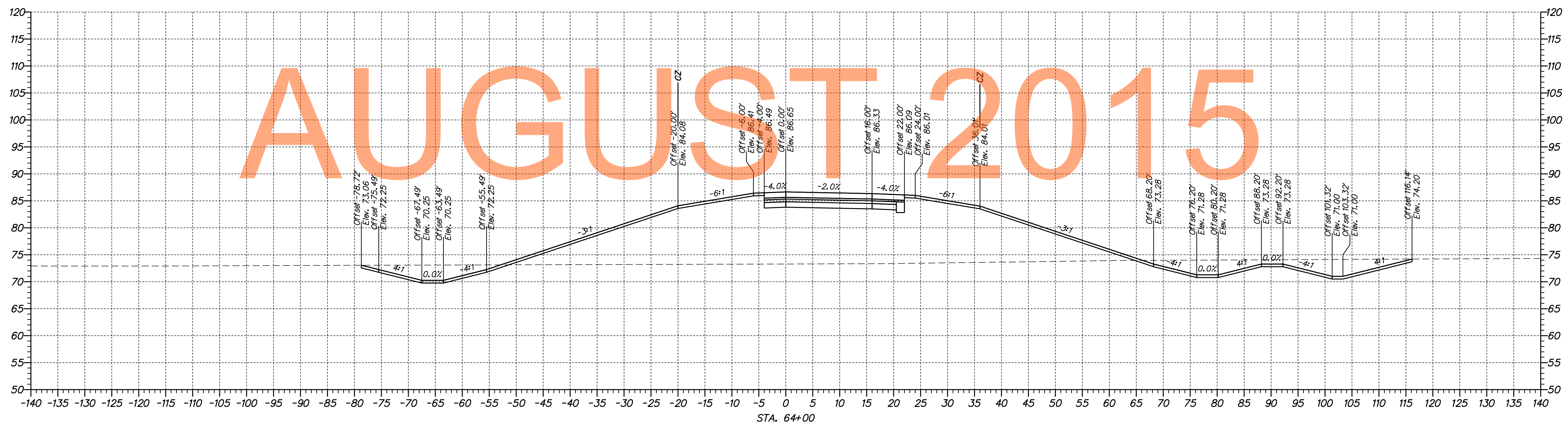
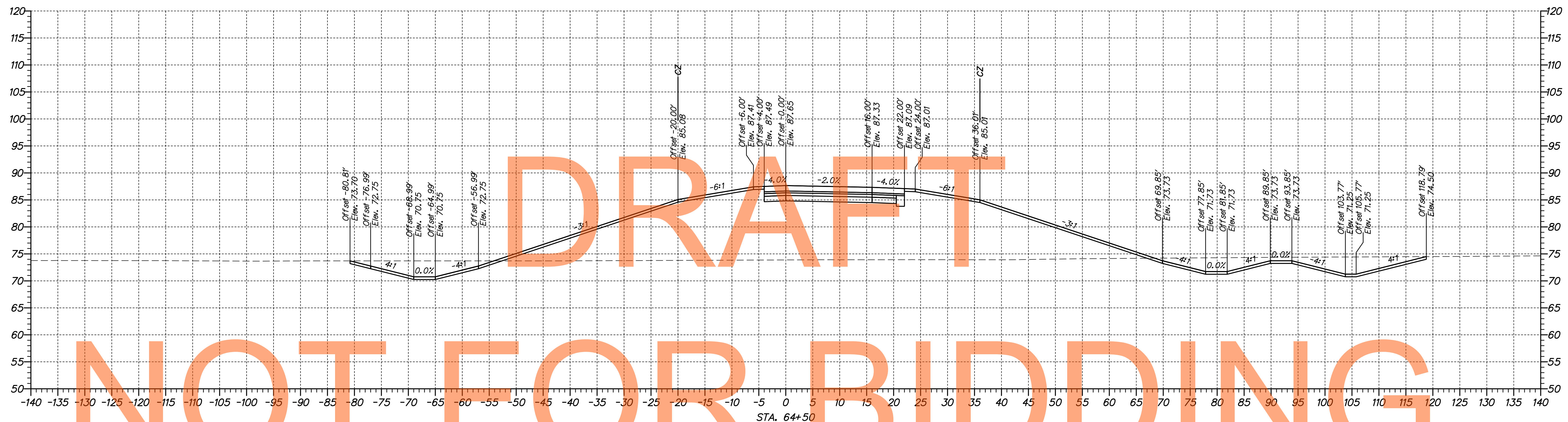

n:\1653-000\con\trac\1a\cadd\US301-1A\_Ramp\_P\_AET\_SectionsBFT.dgn  
 10/30/2014 10:22:53 AM



ADDENDUMS / REVISIONS	

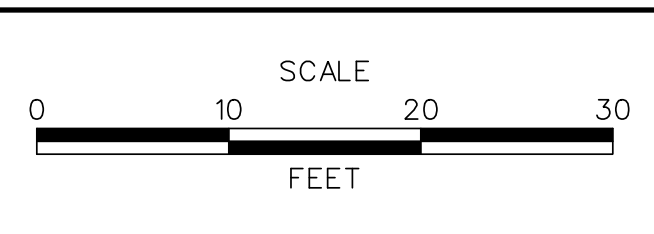

**US 301,  
SR 896 TO SR 1**

CONTRACT T200911308	BRIDGE NO.
COUNTY NEW CASTLE	DESIGNED BY: MEF
	CHECKED BY: TAO

<b>CROSS SECTIONS RAMP P</b>	SHEET NO. 257
	TOTAL SHTS. 337

DRAFT

NOT FOR BIDDING

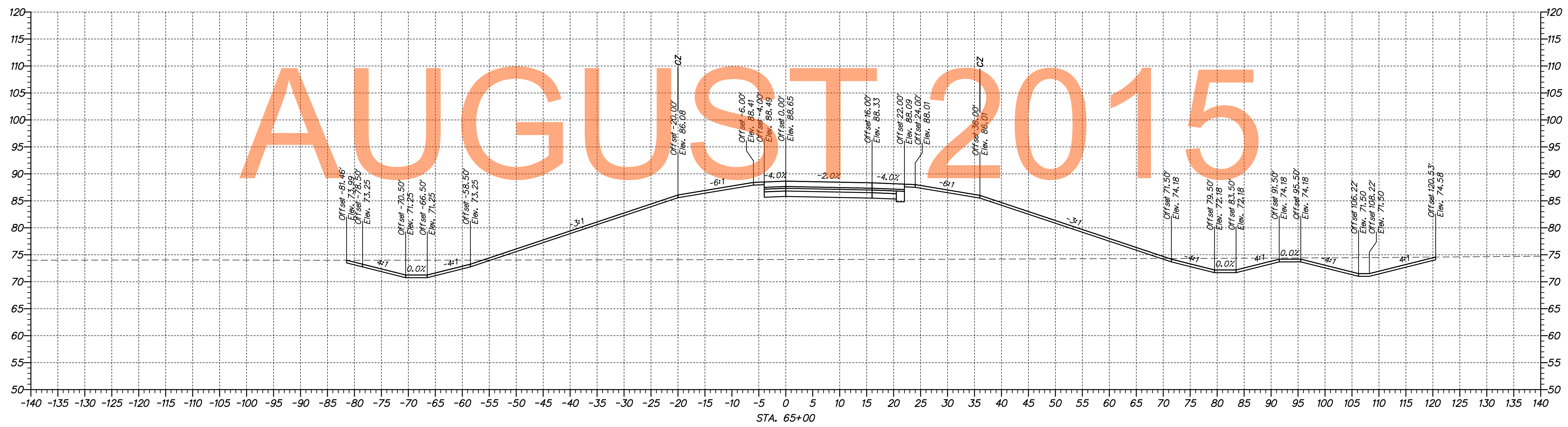
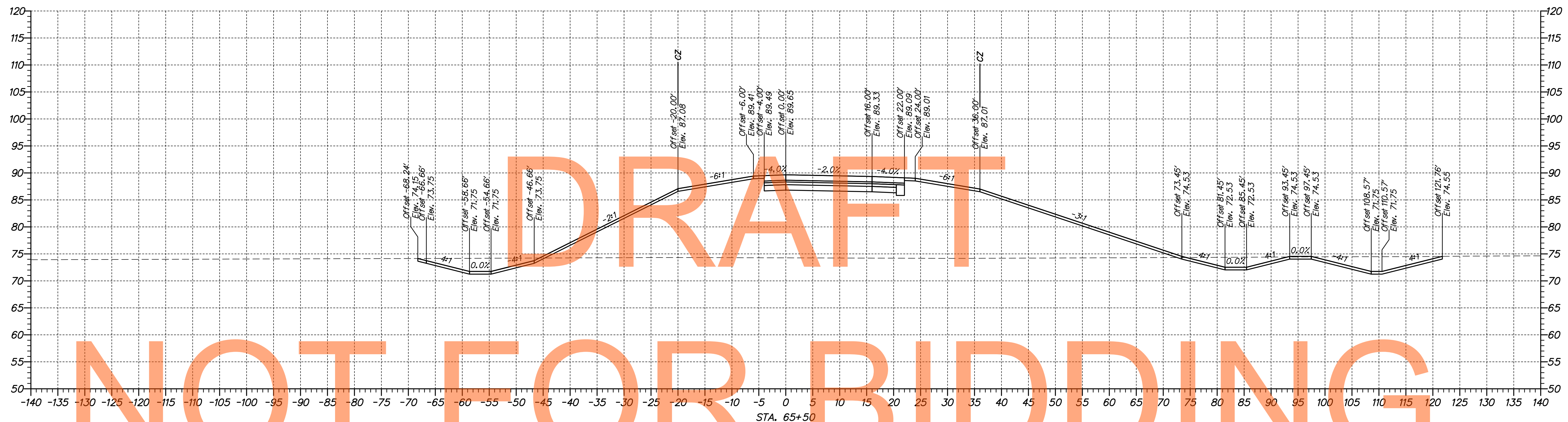

p:\1653-000\con\ref\1a\cadd\US301-1A\_Ramp\_P\_AET\_Sections\BFT.dgn  
 08/30/2014 10:22:57 AM



ADDENDUMS / REVISIONS	

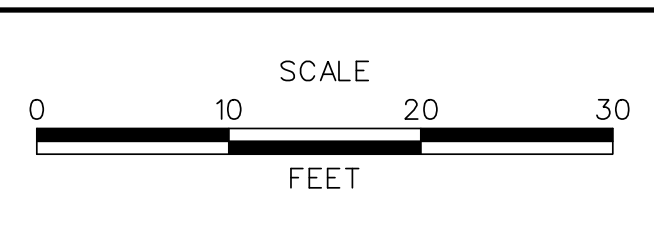

**US 301,  
SR 896 TO SR 1**

CONTRACT	BRIDGE NO.
T200911308	DESIGNED BY: MEF
COUNTY	CHECKED BY: TAO
NEW CASTLE	

<b>CROSS SECTIONS RAMP P</b>	
SHEET NO.	258
TOTAL SHTS.	337



# DRAFT

# NOT FOR BIDDING

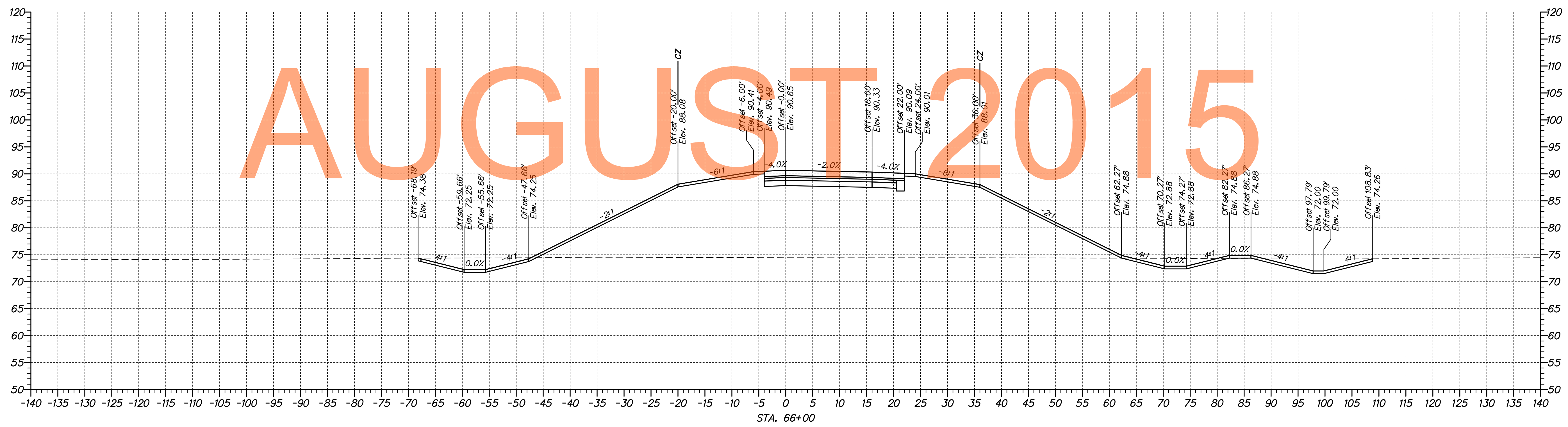
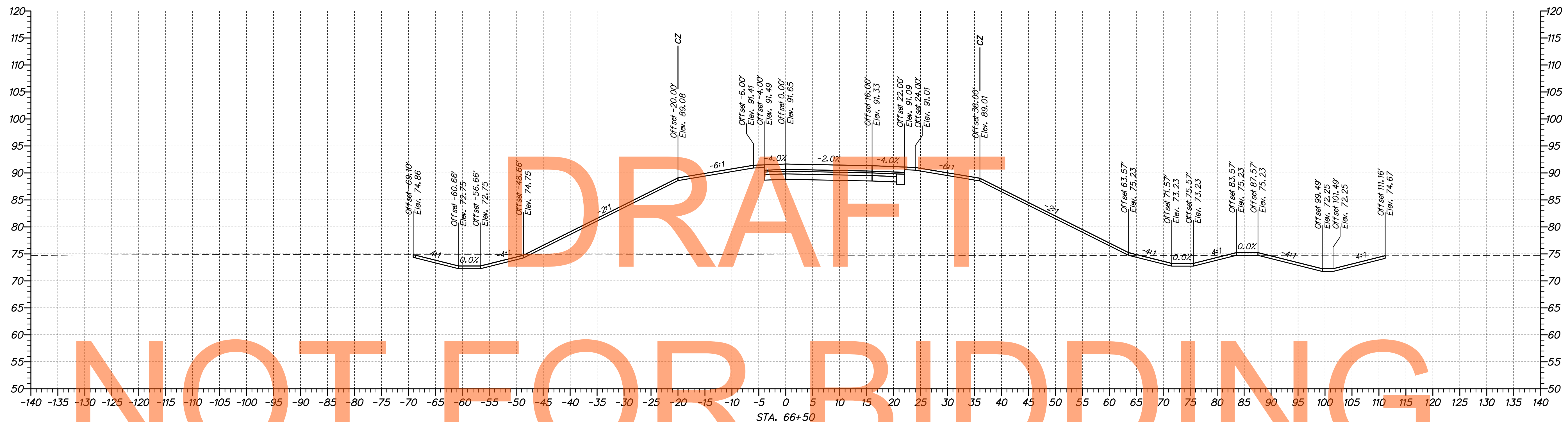

n:\1653-000\contract\1a\cadd\US301-1A\_Ramp\_P\_AET\_Sections\BFT.dgn  
 10/30/2014 10:22:59 AM



ADDENDUMS / REVISIONS	

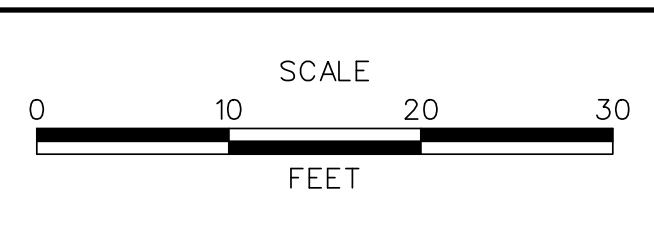

**US 301,  
SR 896 TO SR 1**

CONTRACT	BRIDGE NO.
T200911308	
COUNTY	DESIGNED BY: MEF
NEW CASTLE	CHECKED BY: TAO

<b>CROSS SECTIONS RAMP P</b>	SHEET NO.
	259
<b>CROSS SECTIONS RAMP P</b>	TOTAL SHTS.
	337

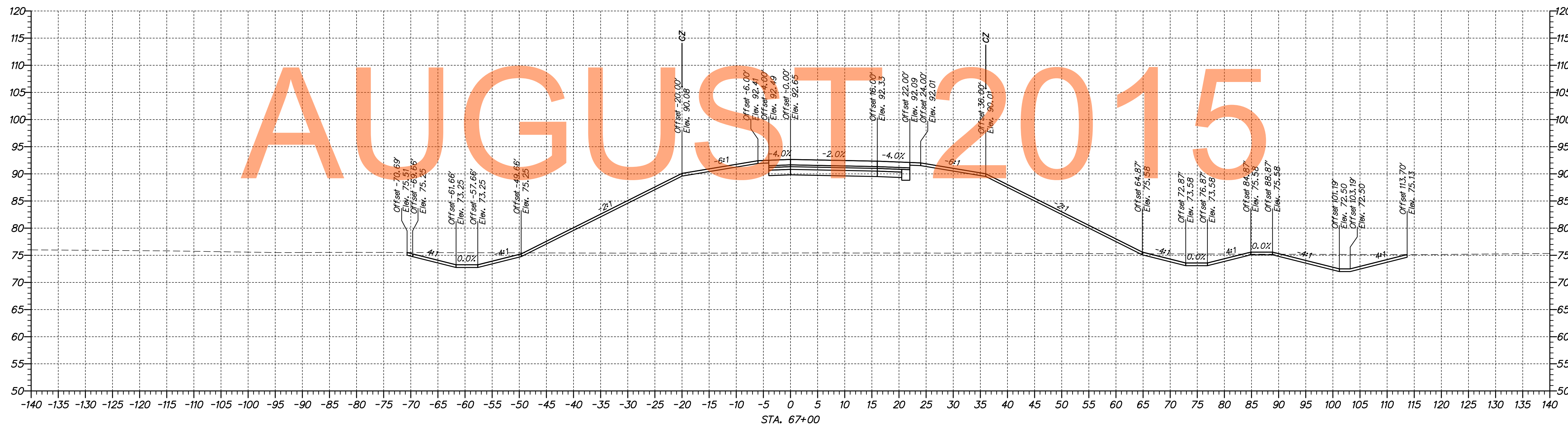
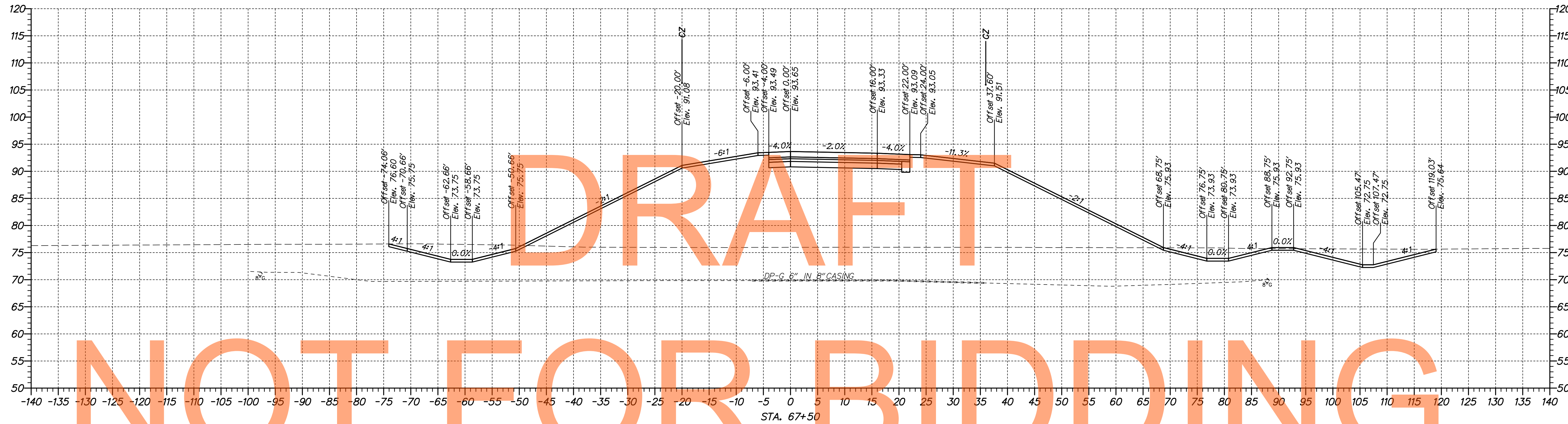

DRAFT

NOT FOR BIDDING

AUGUST 2015

M:\31653\000\Contract\1A\CADD\VS002US301\A\_Ramp\_P.dgn  
 11/27/2014 12:50:58 PM



ADDENDUMS / REVISIONS

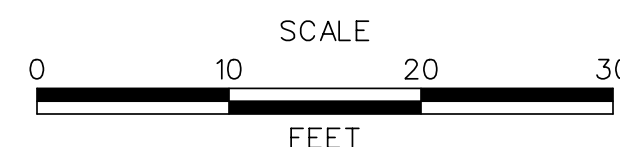

**US 301,  
SR 896 TO SR 1**

CONTRACT	BRIDGE NO.
T200911308	
COUNTY	DESIGNED BY: MEF
NEW CASTLE	CHECKED BY: TAO

**CROSS SECTIONS  
RAMP P**

SHEET NO.
260
TOTAL SHTS.
337

DRAFT

NOT FOR BIDDING

AUGUST 2015

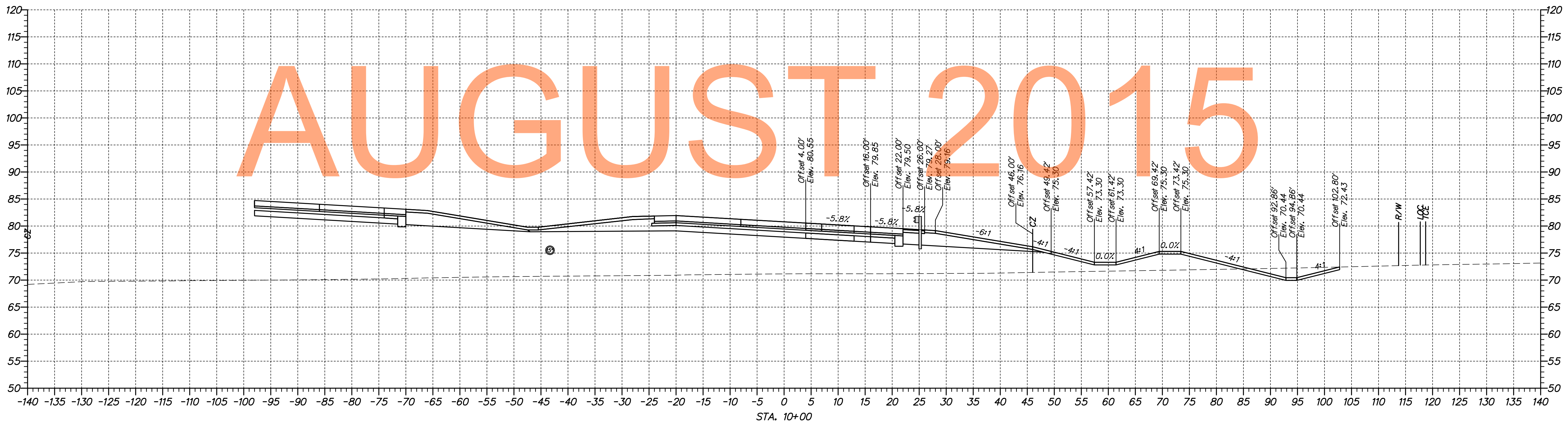
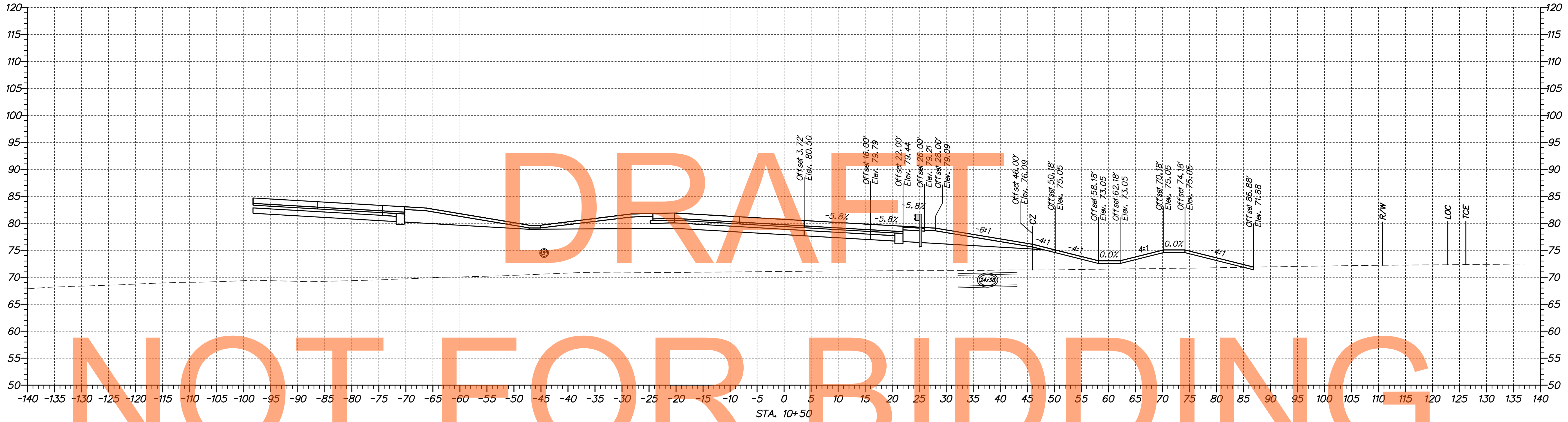

n:\31653-000\1\proj\get\1a\cead\XS002\301\_1A\_Ramp\_N.dgn  
 09/30/2014 10:22:39 AM

DRAFT

NOT FOR BIDDING

AUGUST 2015

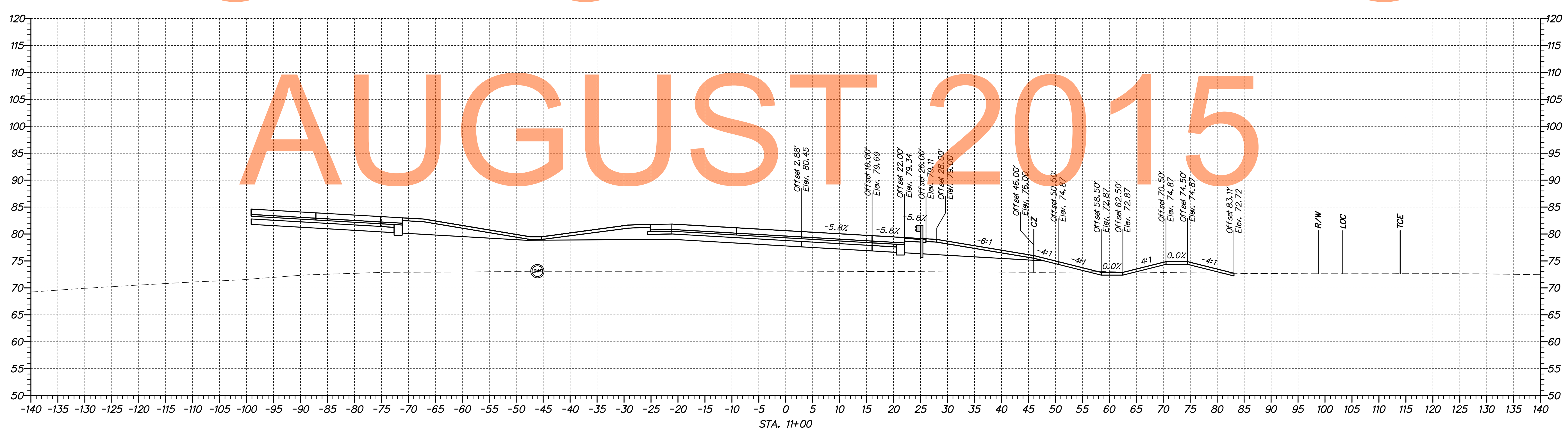
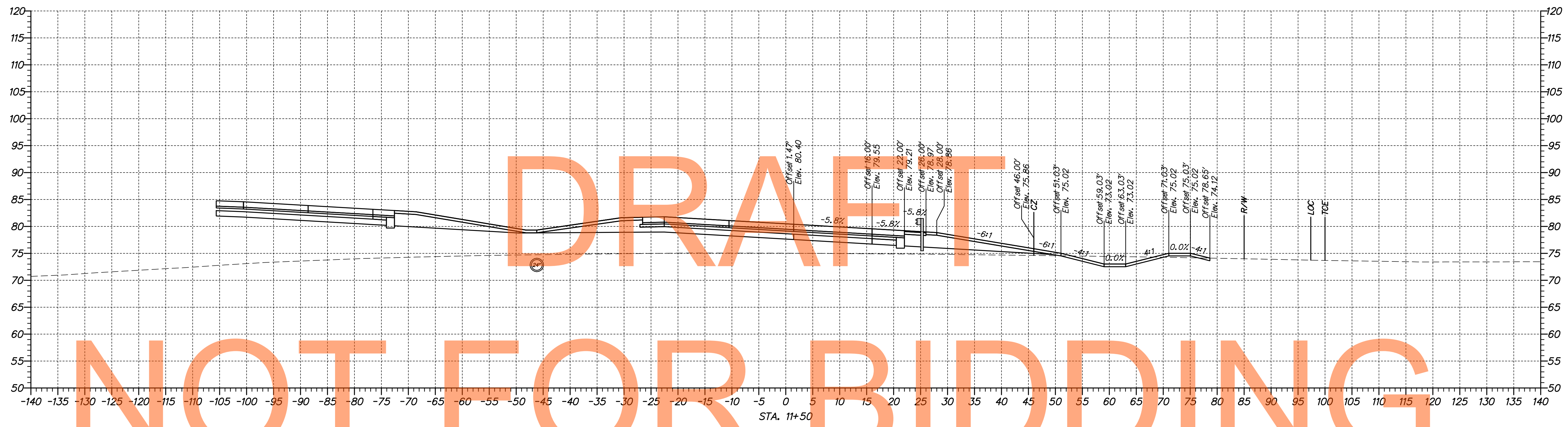

nc:\1653-000\com\project\1a\cadd\XS002\1301\_1A\_Ramp\_N.dgn  
08/30/2014 10:22:54 AM



ADDENDUMS / REVISIONS	

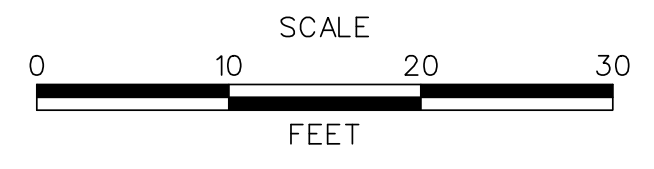

**US 301,  
SR 896 TO SR 1**

CONTRACT T200911308	BRIDGE NO.
COUNTY NEW CASTLE	DESIGNED BY: MEF
	CHECKED BY: TAO

<b>CROSS SECTIONS RAMP N</b>	SHEET NO. 262
	TOTAL SHTS. 337

DRAFT

NOT FOR BIDDING

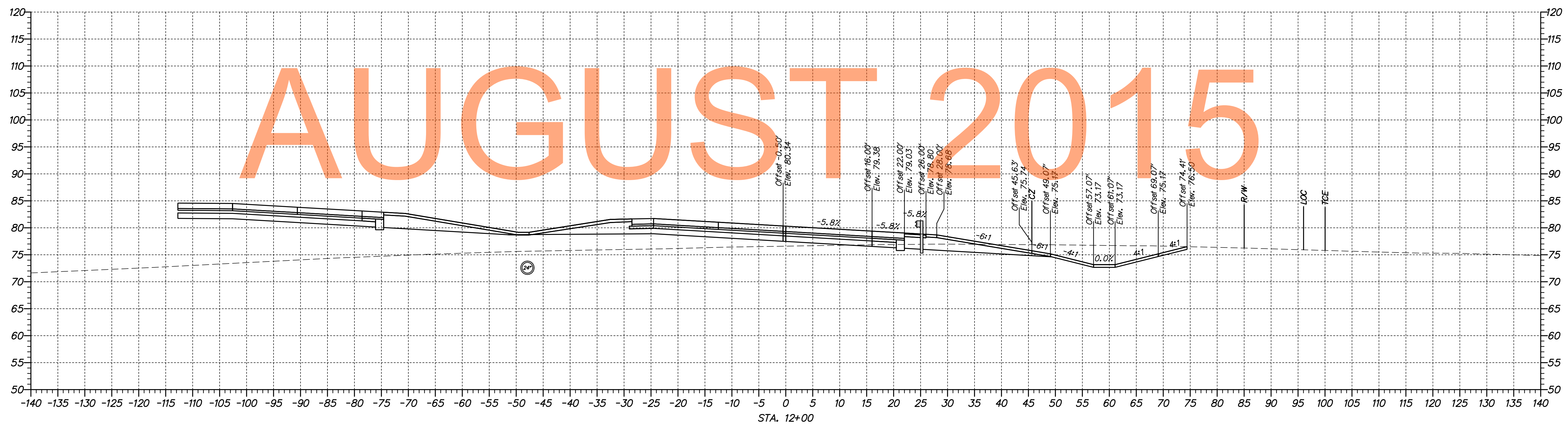
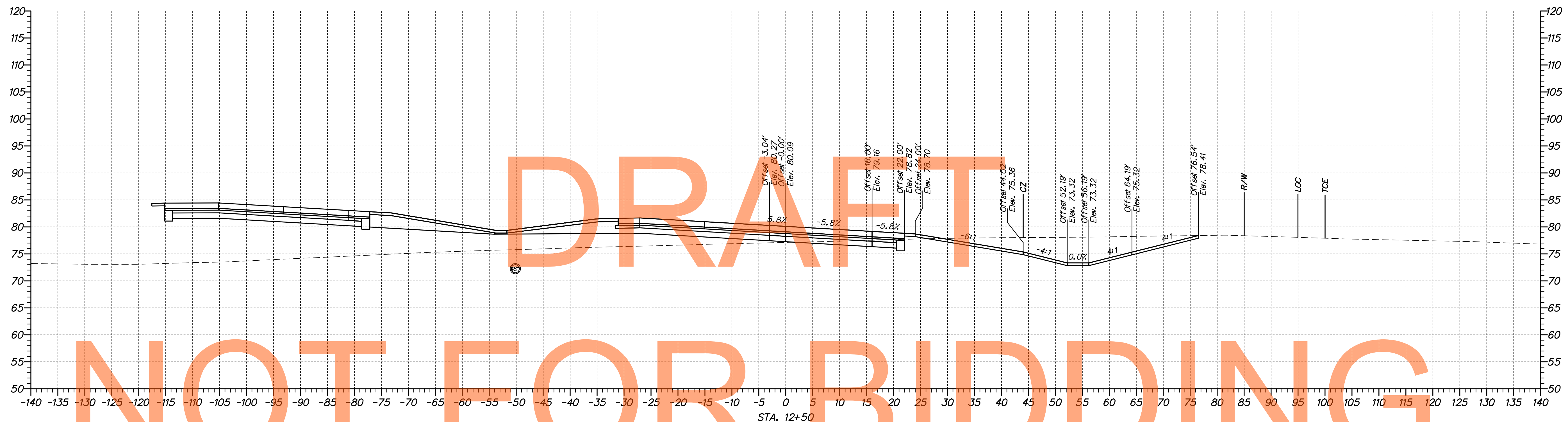

n:\1653-000\cm\mfg\1653-000\120214-102247.dgn  
 20/20/2014 10:22:47 AM

**DELAWARE DEPARTMENT OF TRANSPORTATION**

ADDENDUMS / REVISIONS

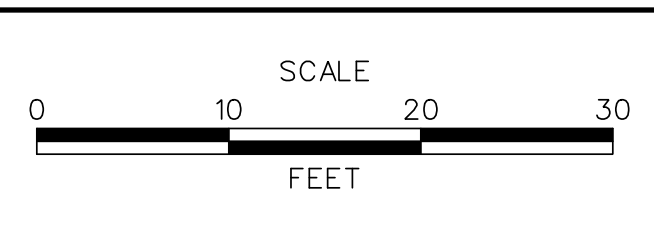

**US 301, SR 896 TO SR 1**

CONTRACT T200911308	BRIDGE NO. 
COUNTY NEW CASTLE	DESIGNED BY: MEF CHECKED BY: TAO

**CROSS SECTIONS RAMP N**

SHEET NO. 263
TOTAL SHTS. 337

DRAFT

NOT FOR BIDDING

AUGUST 2015

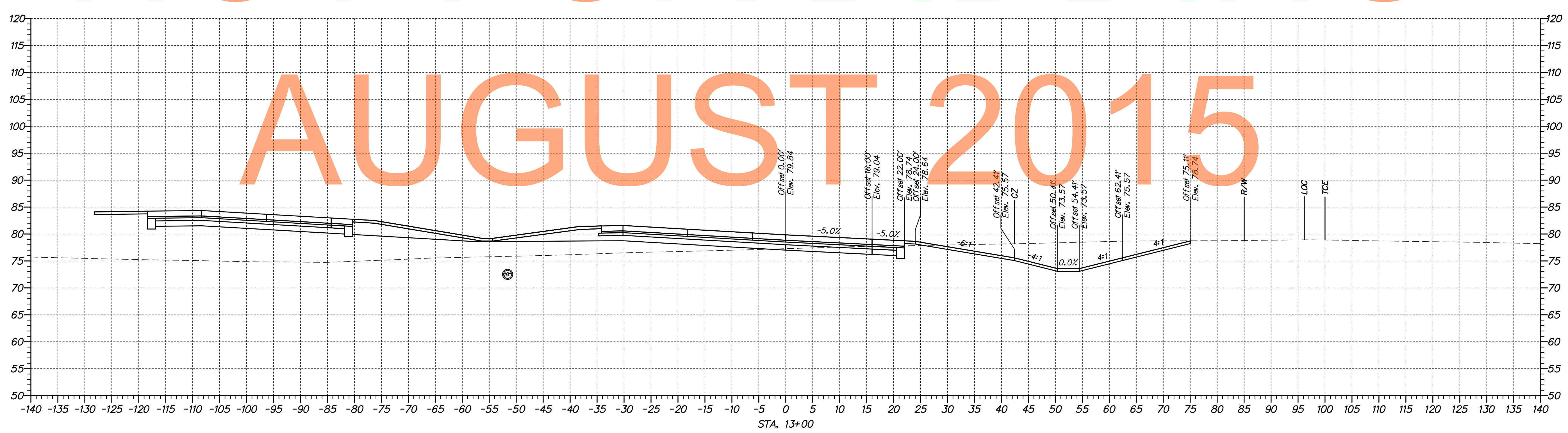
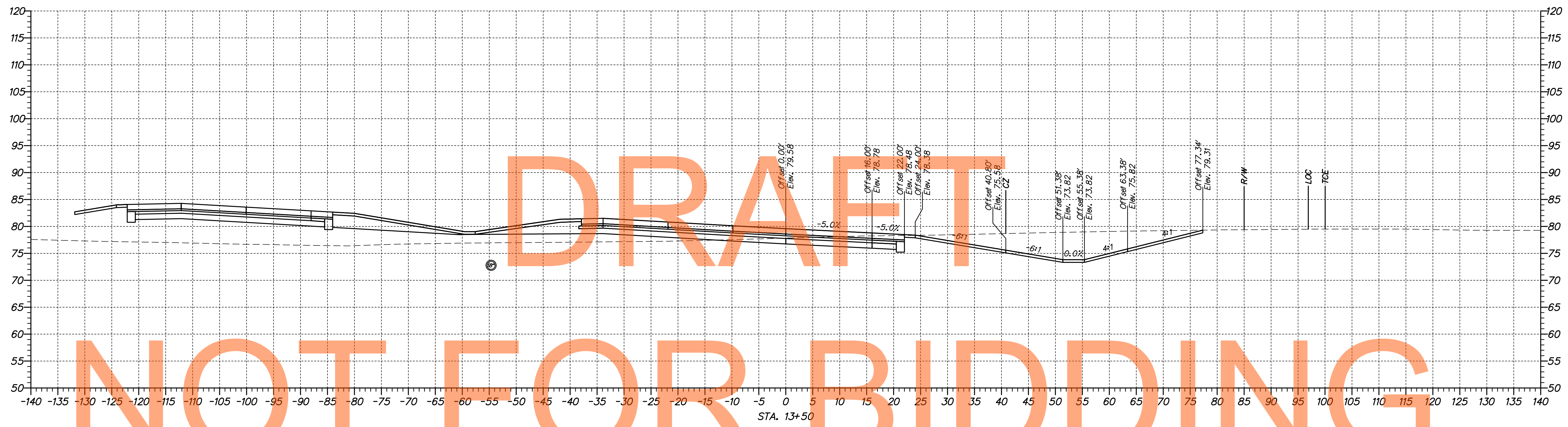

\\s002\1301\_1A\_Ramp\_N.dgn 10/20/2014 10:22:49 AM



ADDENDUMS / REVISIONS	

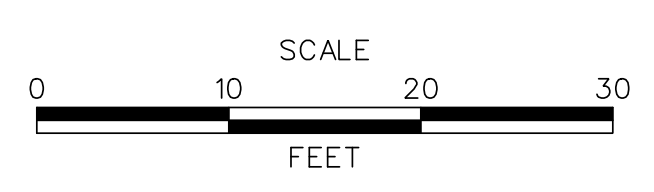

US 301, SR 896 TO SR 1

CONTRACT T200911308	BRIDGE NO.
COUNTY NEW CASTLE	DESIGNED BY: MEF
	CHECKED BY: TAO

CROSS SECTIONS RAMP N

SHEET NO. 264
TOTAL SHTS. 337

DRAFT

NOT FOR BIDDING

AUGUST 2015

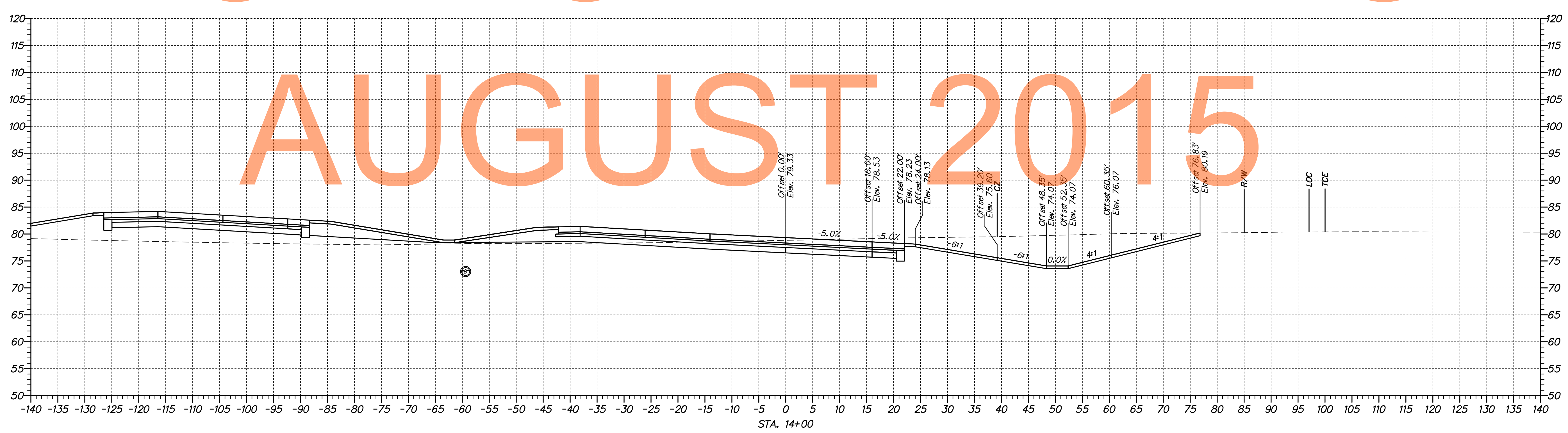
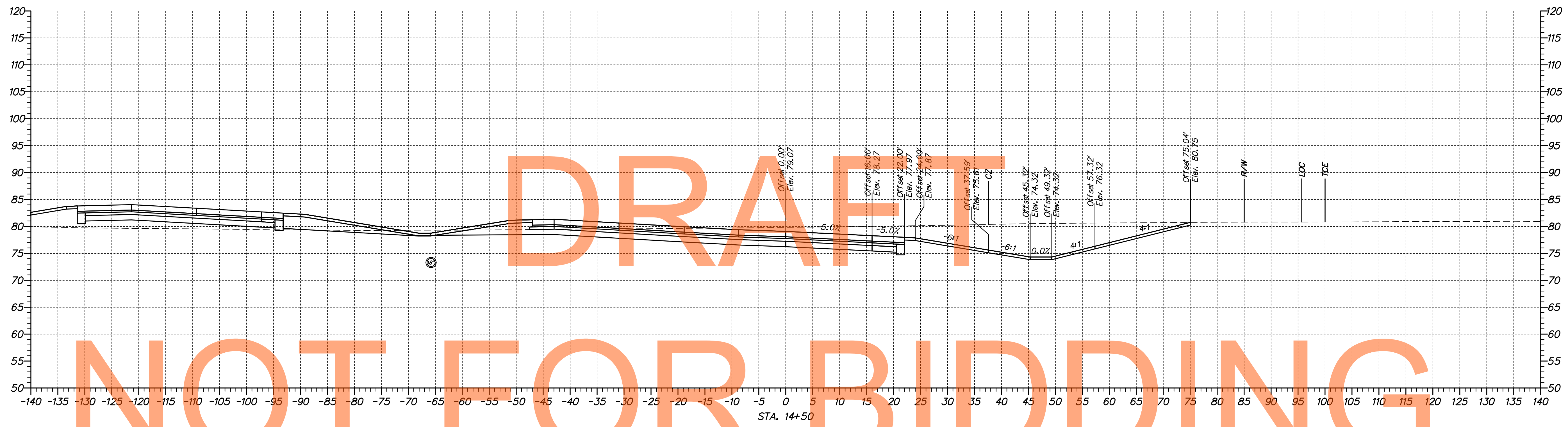

\\1653-000\cadd\project\14\cadd\XS002\1301\_1A\_Ramp\_N.dgn 08/30/2014 10:22:51 AM



ADDENDUMS / REVISIONS	

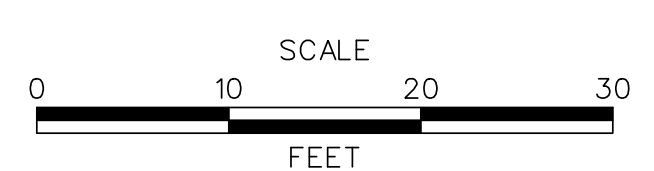

US 301, SR 896 TO SR 1

CONTRACT T200911308	BRIDGE NO.
COUNTY NEW CASTLE	DESIGNED BY: MEF
	CHECKED BY: TAO

CROSS SECTIONS RAMP N

SHEET NO. 265
TOTAL SHTS. 337

DRAFT  
NOT FOR BIDDING

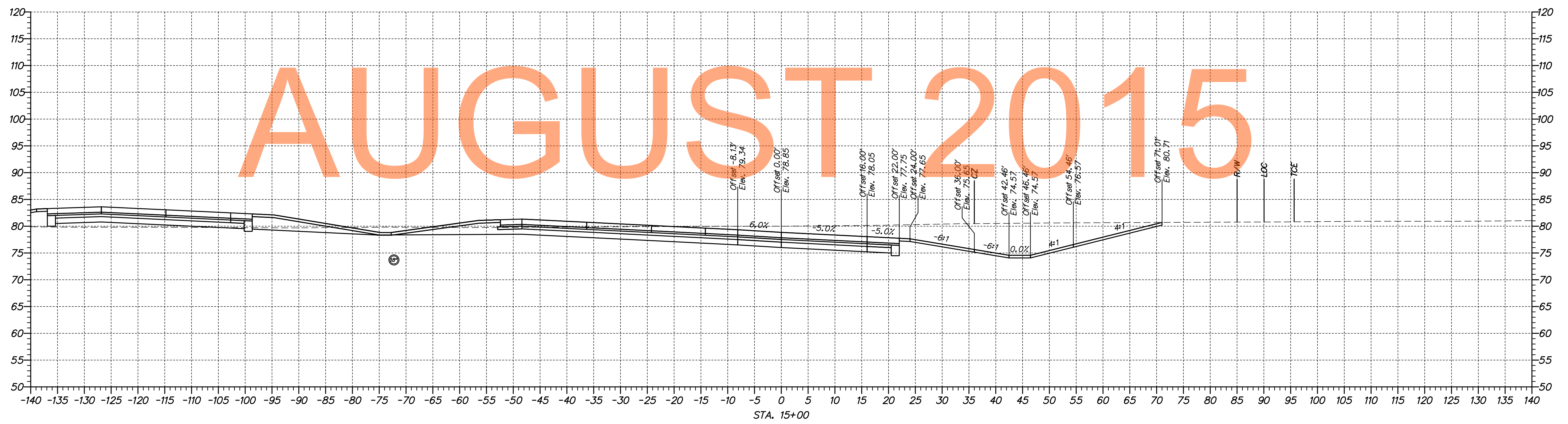
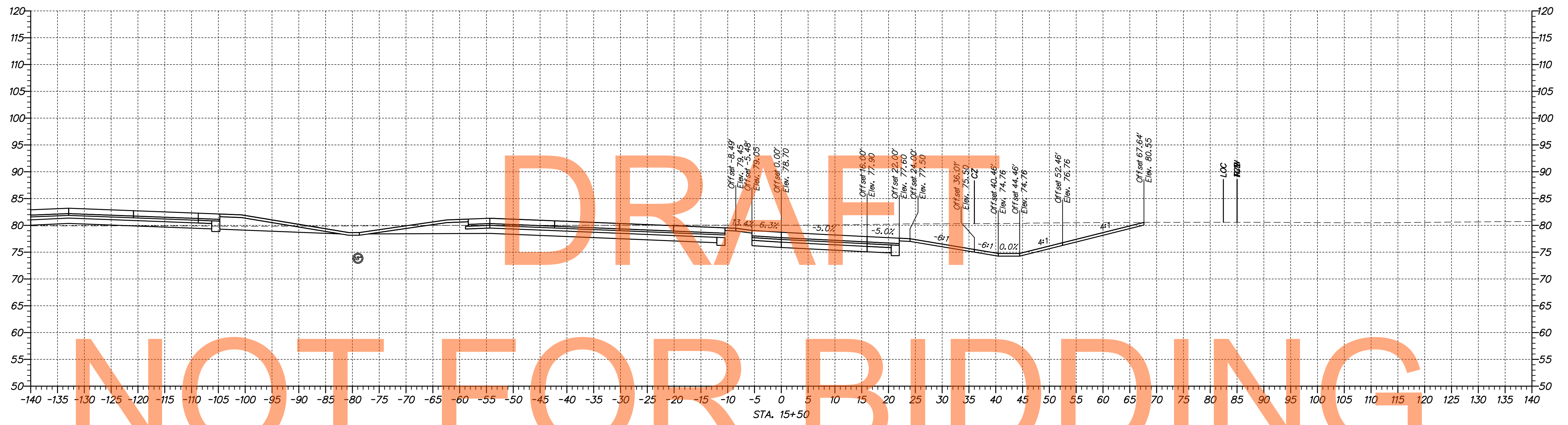

\\s1653-000\000\proj\delaware\AS002\301\_1A\_Ramp\_N.dgn 10/30/2014 10:22:53 AM

**DELAWARE**  
DEPARTMENT OF TRANSPORTATION

ADDENDUMS / REVISIONS	

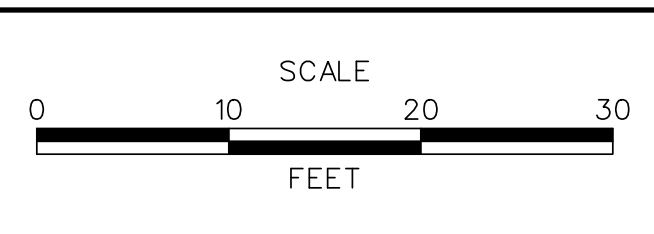

**US 301,  
SR 896 TO SR 1**

CONTRACT T200911308	BRIDGE NO.
COUNTY NEW CASTLE	DESIGNED BY: MEF CHECKED BY: TAO

<b>CROSS SECTIONS RAMP N</b>	SHEET NO. 266
	TOTAL SHTS. 337



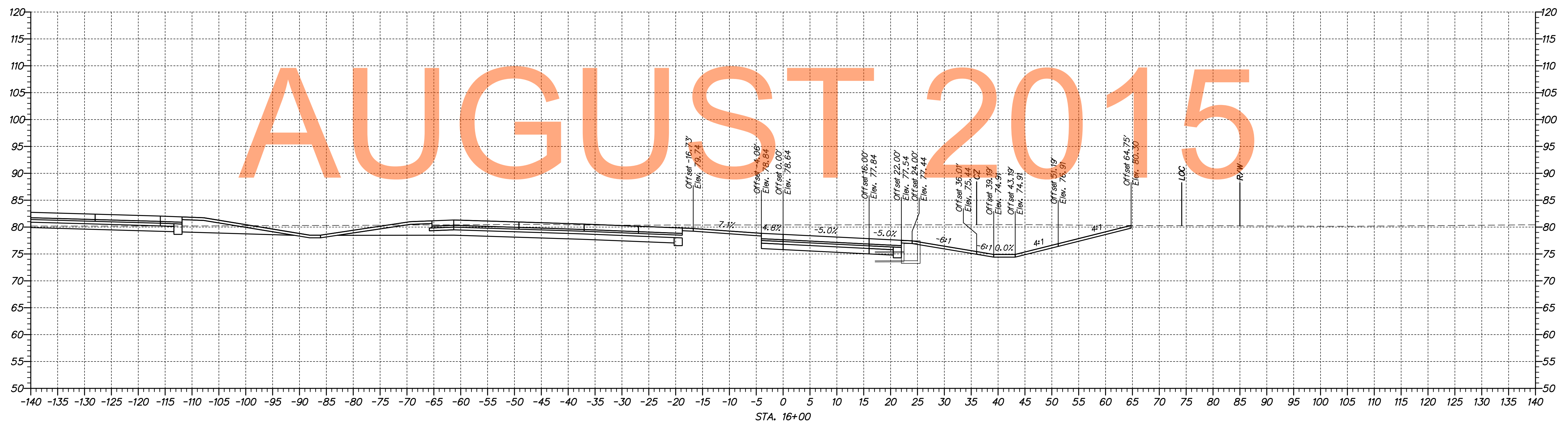
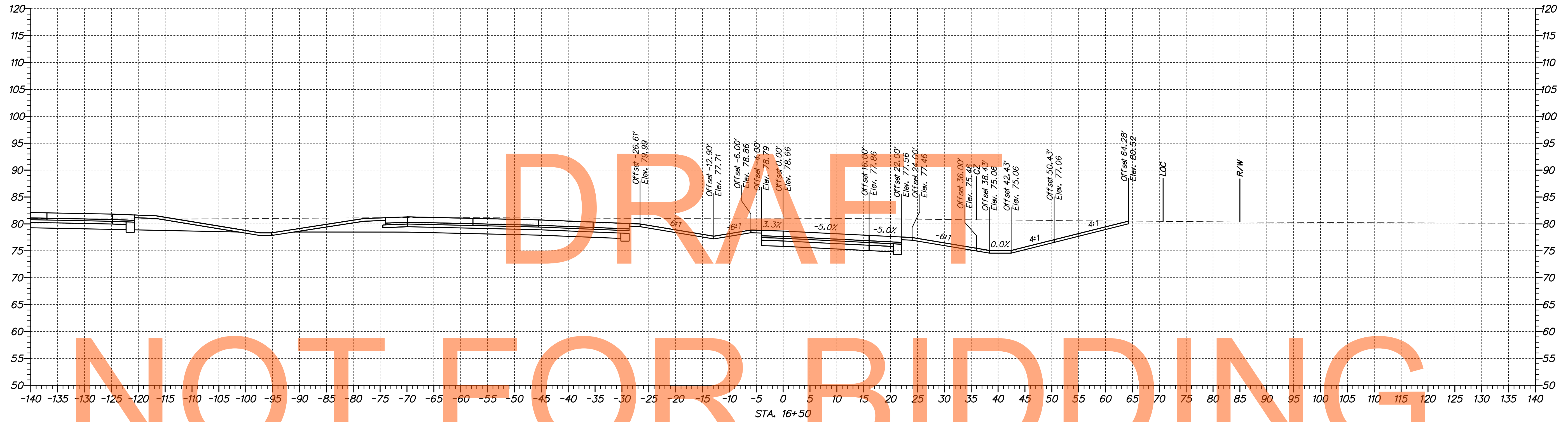

NOT FOR BIDDING

AUGUST 2015

p:\1653-000\contract\1653\cadd\XS002\301\_1A\_Ramp\_N.dgn  
 08/30/2014 10:22:54 AM

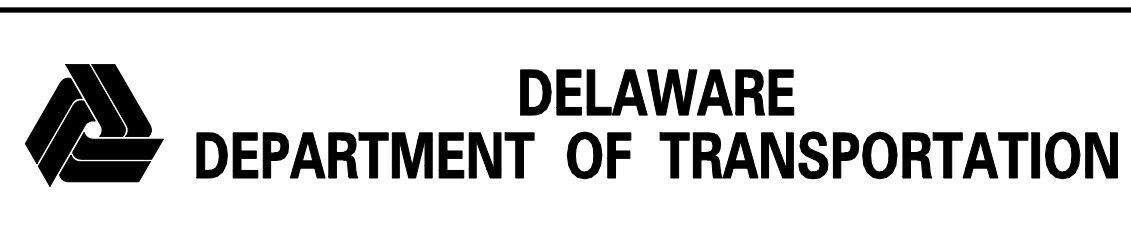

ADDENDUMS / REVISIONS	

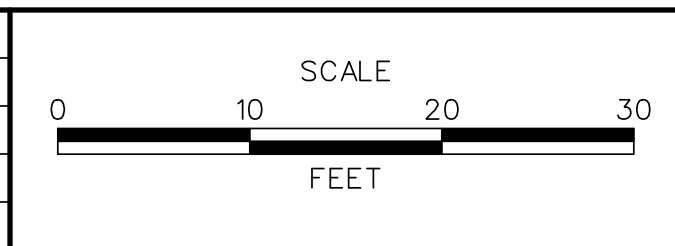

**US 301,  
SR 896 TO SR 1**

CONTRACT T200911308	BRIDGE NO.
COUNTY NEW CASTLE	DESIGNED BY: MEF
	CHECKED BY: TAO

<b>CROSS SECTIONS RAMP N</b>	SHEET NO. 267
	TOTAL SHTS. 337

DRAFT

NOT FOR BIDDING

AUGUST 2015

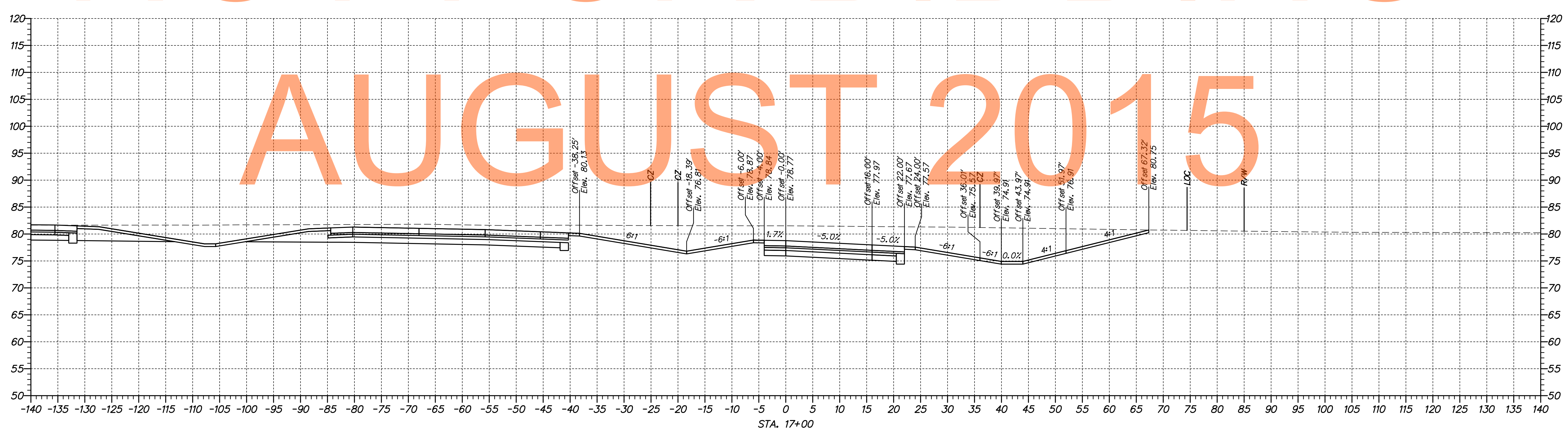
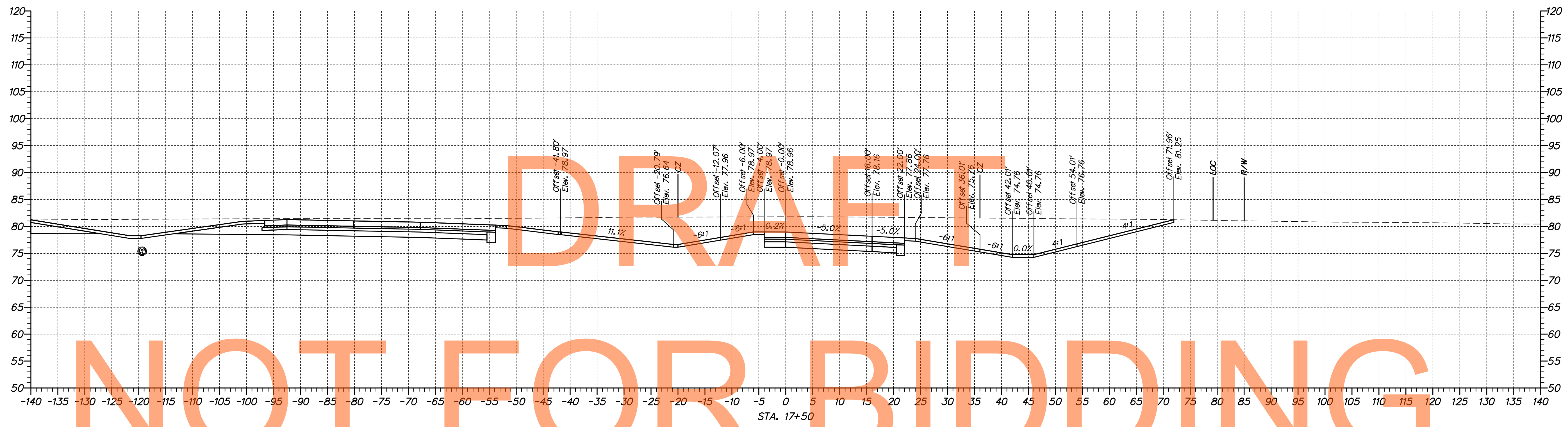

\\s002\1301\_1A\_Ramp\_N.dgn 10/20/14 10:22:59 AM



ADDENDUMS / REVISIONS	

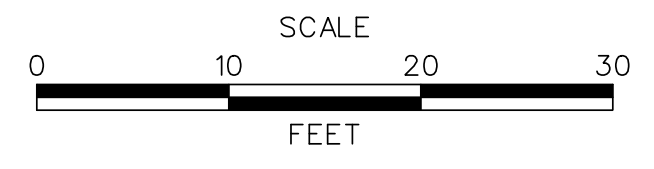

US 301, SR 896 TO SR 1

CONTRACT T200911308	BRIDGE NO.
COUNTY NEW CASTLE	DESIGNED BY: MEF
	CHECKED BY: TAO

CROSS SECTIONS RAMP N

SHEET NO. 268
TOTAL SHTS. 337

DRAFT

NOT FOR BIDDING

AUGUST 2015

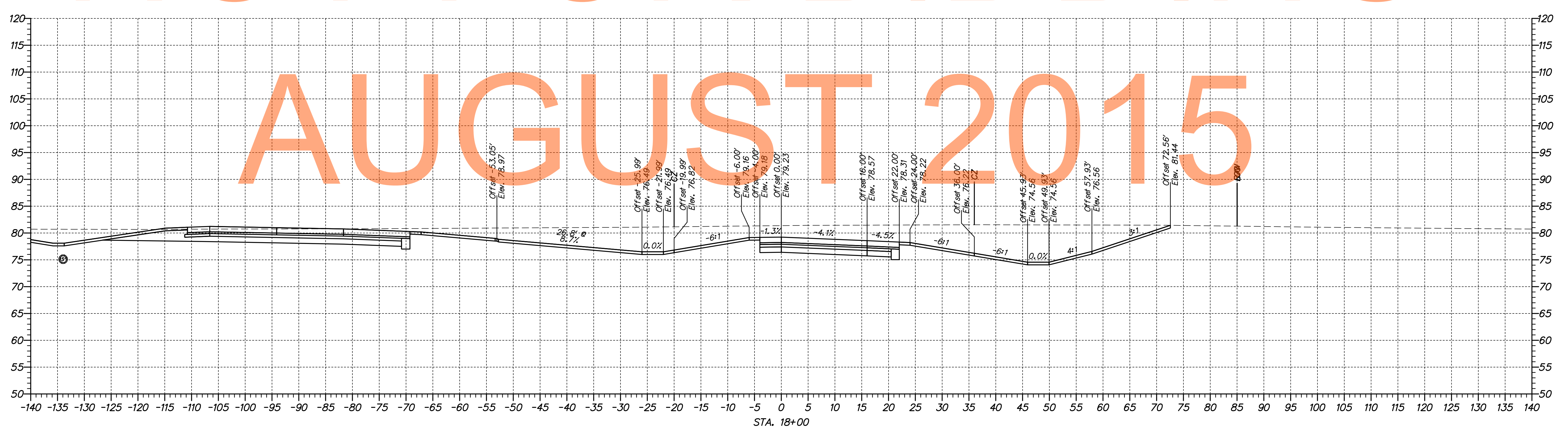
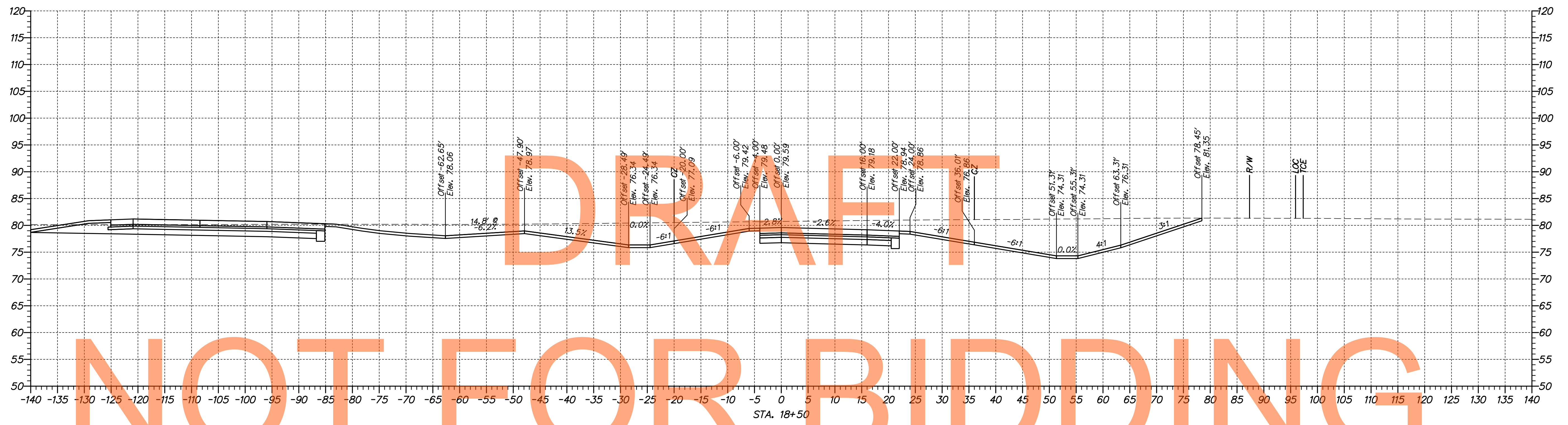

\\1653-000\con\gract\p\cead\XS002\301\_1A\_Ramp\_N.dgn 08/30/2014 10:22:58 AM

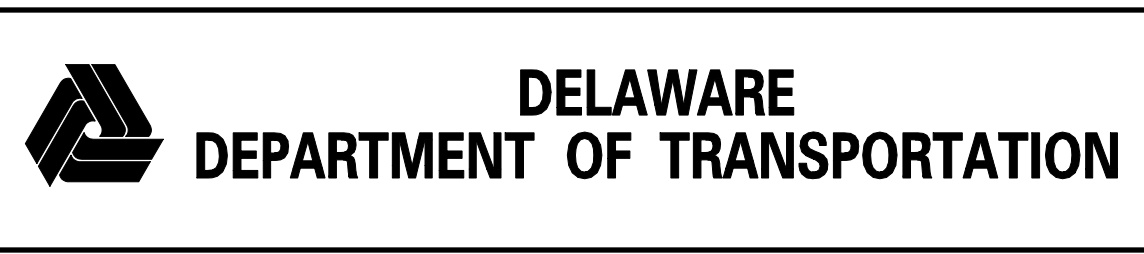

ADDENDUMS / REVISIONS	

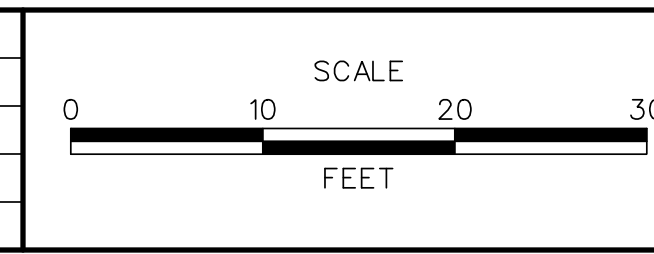

US 301,  
SR 896 TO SR 1

CONTRACT T200911308	BRIDGE NO.
COUNTY NEW CASTLE	DESIGNED BY: MEF
	CHECKED BY: TAO

CROSS SECTIONS RAMP N	SHEET NO. 269
	TOTAL SHTS. 337

DRAFT

NOT FOR BIDDING

AUGUST 2015

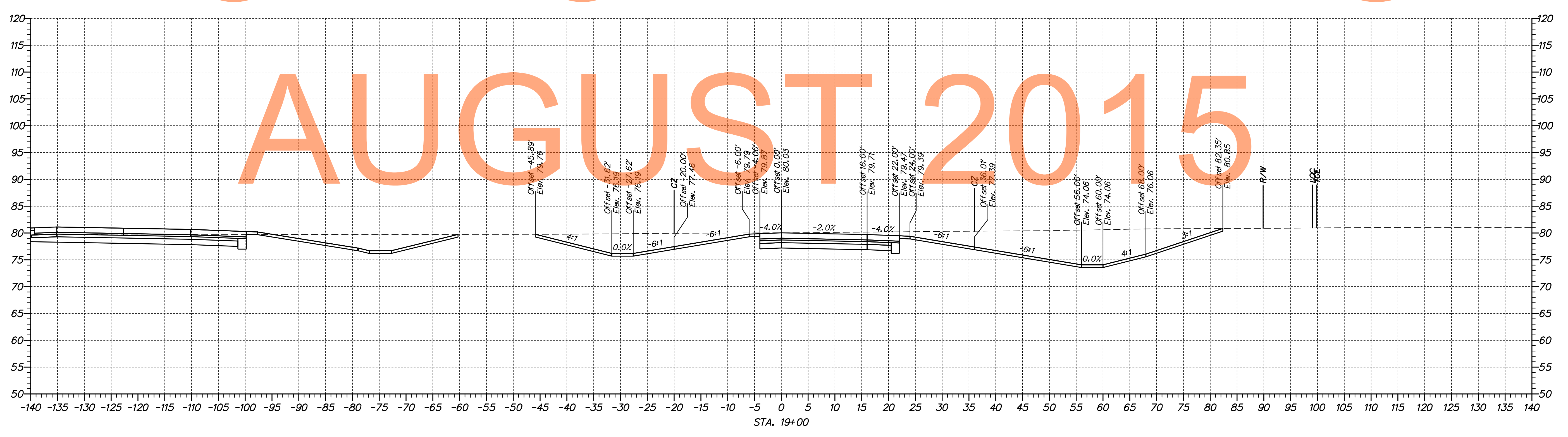
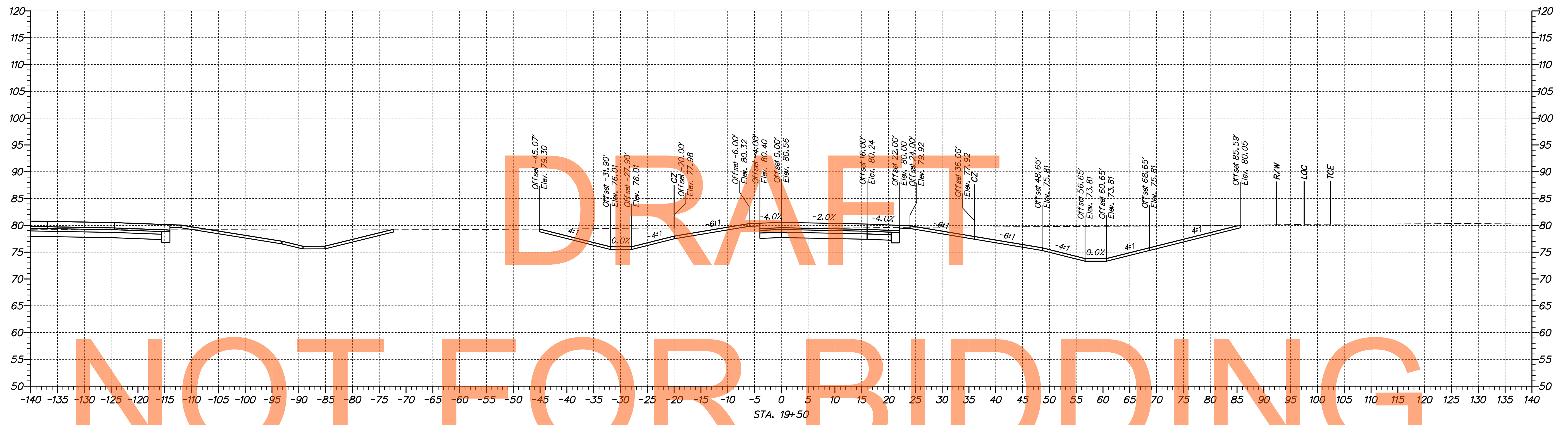

\\1653-000\scm\cct\p\cead\X5002\301\_1A\_Ramp\_N.dgn 08/30/2014 10:52:50 AM

ADDENDUMS / REVISIONS	

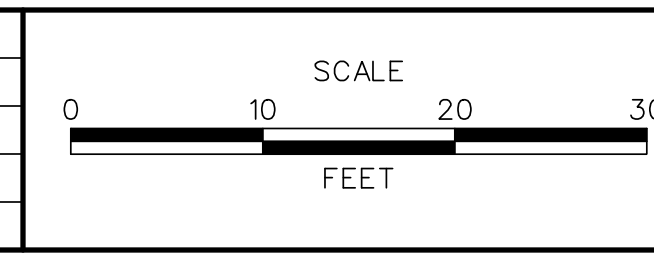

**US 301,  
SR 896 TO SR 1**

CONTRACT T200911308	BRIDGE NO.
COUNTY NEW CASTLE	DESIGNED BY: MEF
	CHECKED BY: TAO

<b>CROSS SECTIONS RAMP N</b>
SHEET NO. 270
TOTAL SHTS. 337

DRAFT

NOT FOR BIDDING

AUGUST 2015

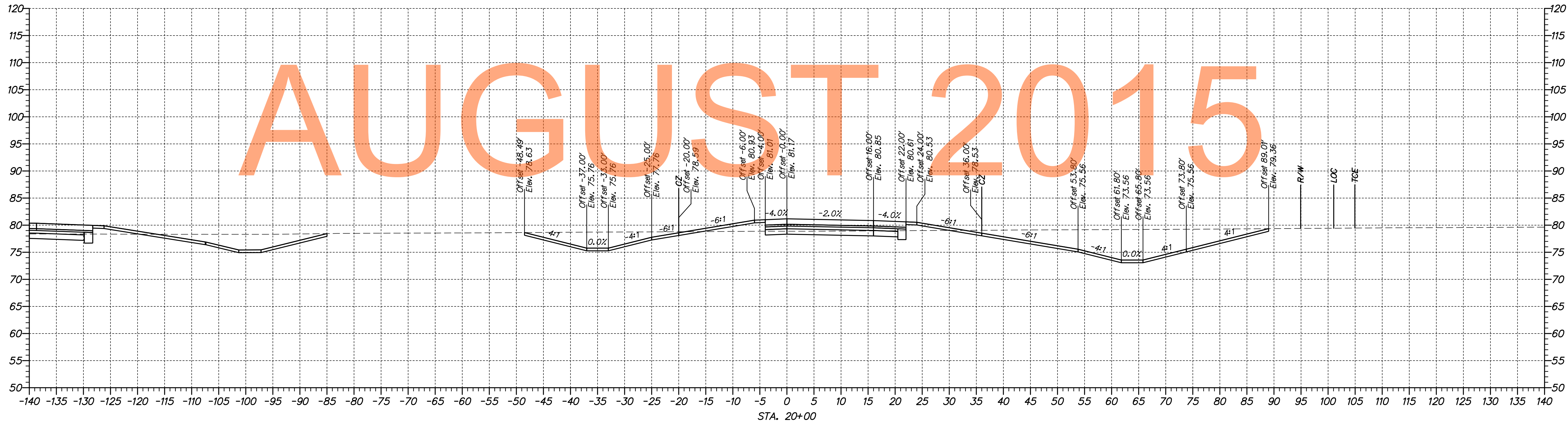
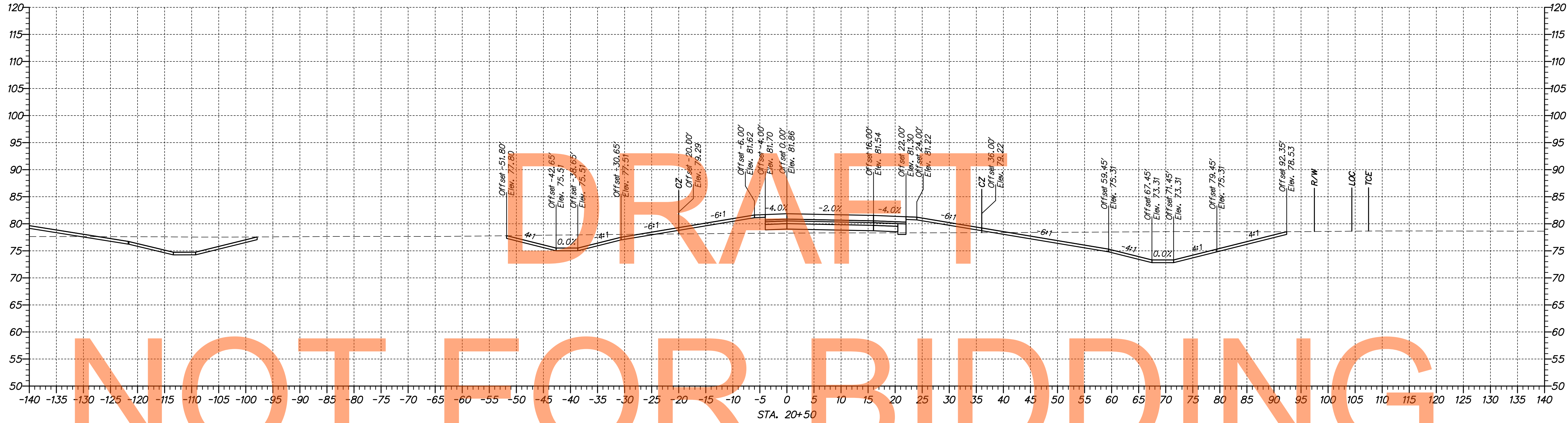

ADDENDUMS / REVISIONS

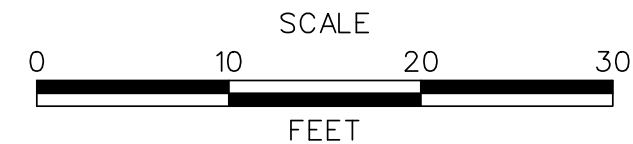

US 301, SR 896 TO SR 1

CONTRACT	BRIDGE NO.
T200911308	DESIGNED BY: MEF
COUNTY	CHECKED BY: TAO
NEW CASTLE	

CROSS SECTIONS RAMP N

SHEET NO.
271
TOTAL SHTS.
337

NOT FOR BIDDING

AUGUST 2015

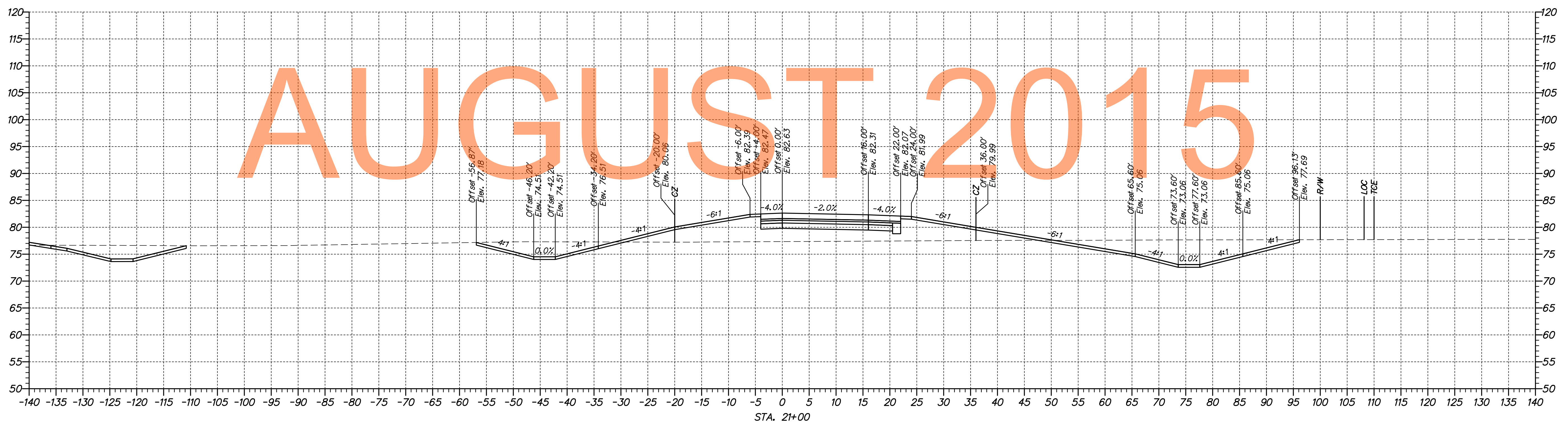
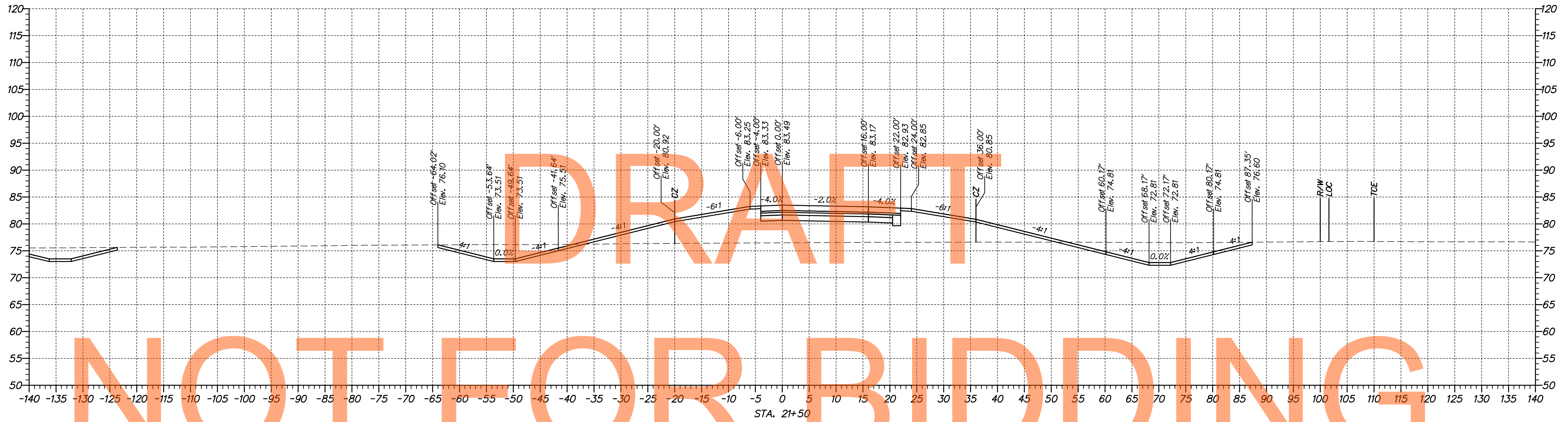

\\s002\301\_1A\_Ramp\_N.dgn 20/2014 10:25:04 AM



ADDENDUMS / REVISIONS	

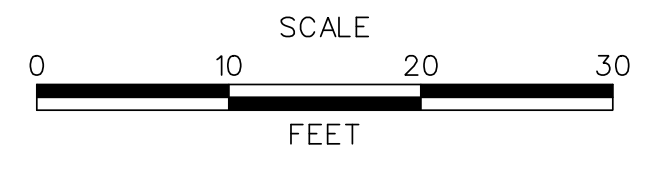

US 301,  
SR 896 TO SR 1

CONTRACT	BRIDGE NO.
T200911308	DESIGNED BY: MEF
COUNTY	CHECKED BY: TAO
NEW CASTLE	

CROSS SECTIONS RAMP N	SHEET NO.
	272
TOTAL SHTS.	337

NOT FOR BIDDING

AUGUST 2015

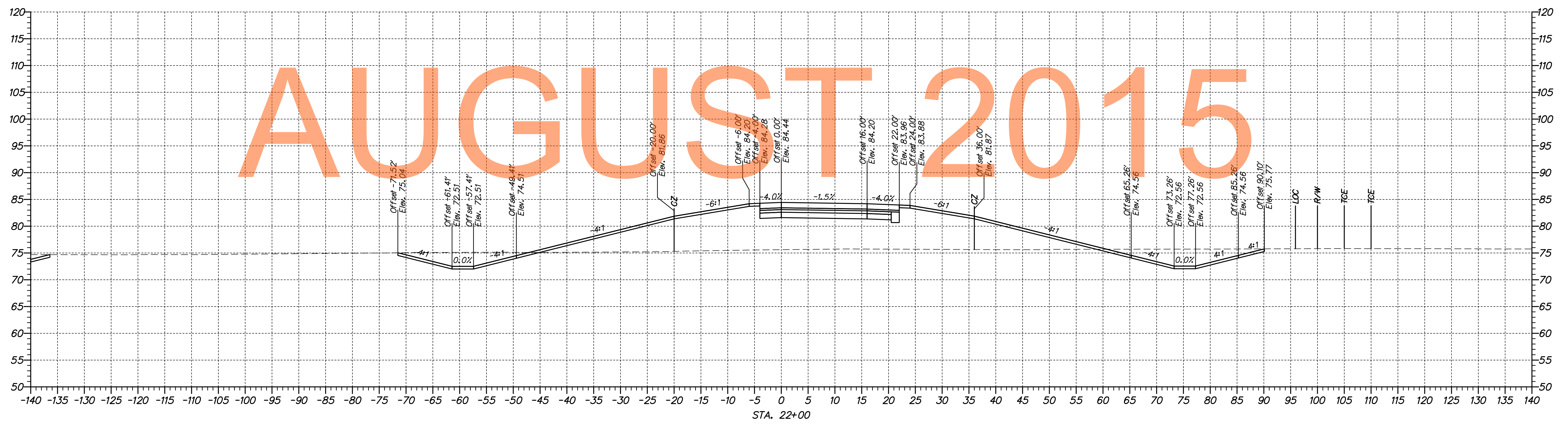
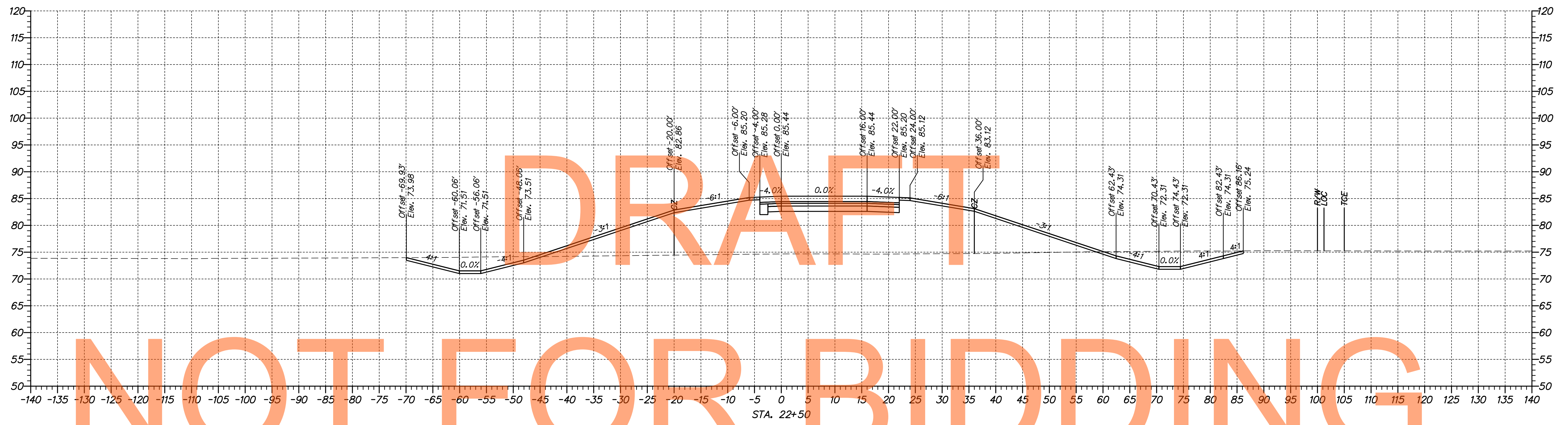

p:\1653-000-000\civil\cct\1a\cadd\X5002\301\_1A\_Ramp\_N.dgn  
 08/30/2014 10:52:56 AM

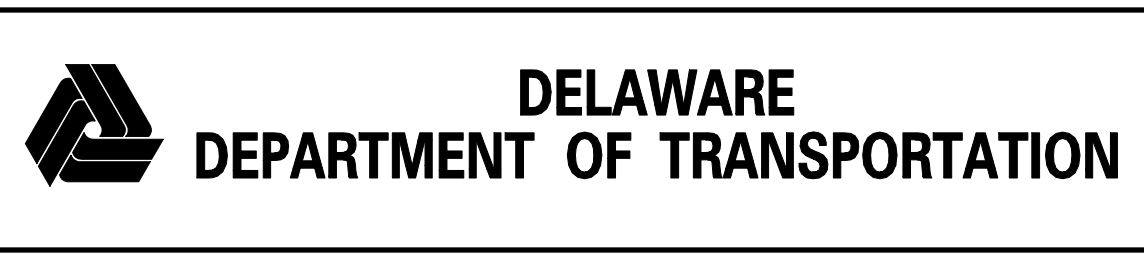

ADDENDUMS / REVISIONS	

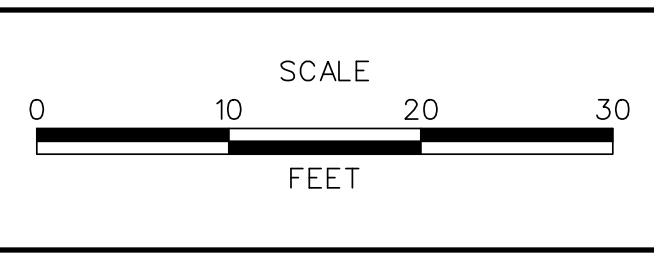

US 301,  
SR 896 TO SR 1

CONTRACT	T200911308
COUNTY	NEW CASTLE
BRIDGE NO.	
DESIGNED BY:	MEF
CHECKED BY:	TAO

CROSS SECTIONS RAMP N	SHEET NO.	273
	TOTAL SHTS.	337

# DRAFT

# NOT FOR BIDDING

# AUGUST 2015

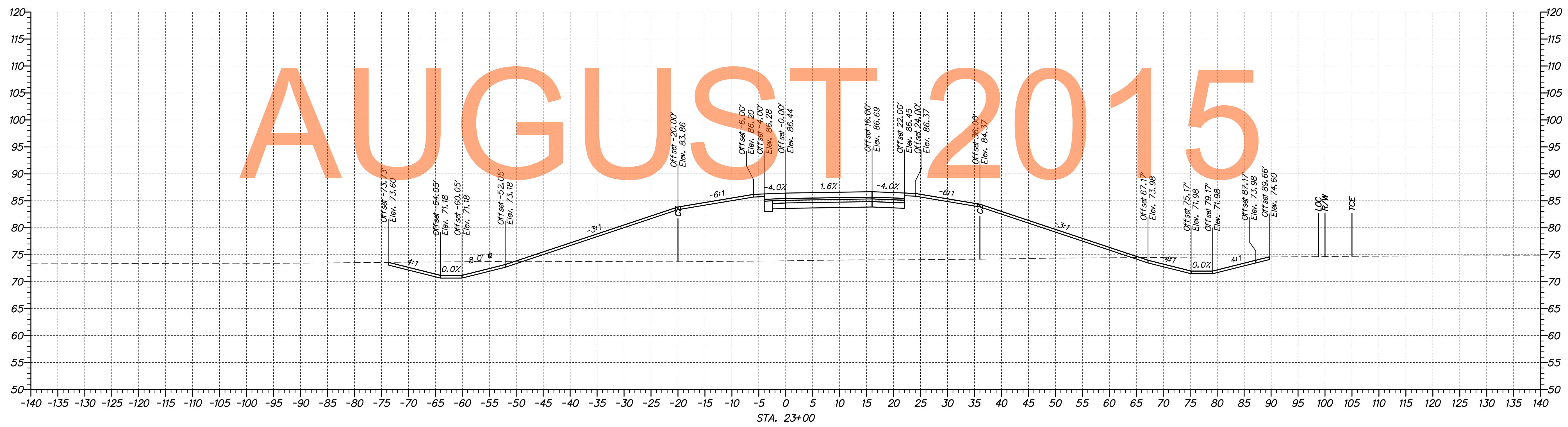
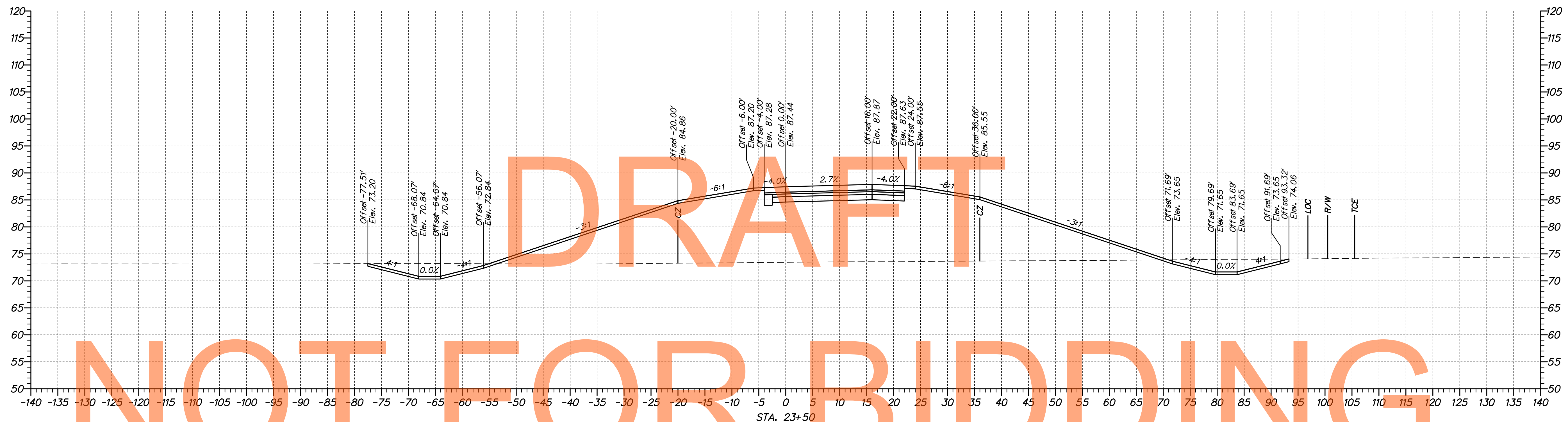

p:\1653-000\sect\sect\1a\cead\XS002\301\_1A\_Ramp\_N.dgn  
 08/20/2014 10:52:08 AM



ADDENDUMS / REVISIONS	

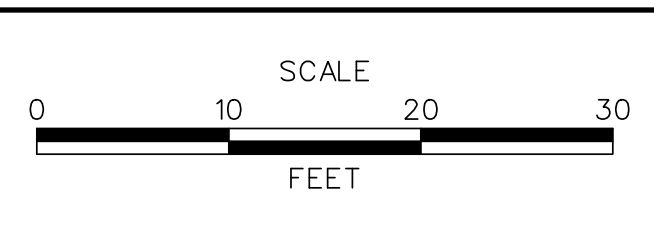

**US 301,  
SR 896 TO SR 1**

CONTRACT T200911308	BRIDGE NO.
COUNTY NEW CASTLE	DESIGNED BY: MEF
	CHECKED BY: TAO

<b>CROSS SECTIONS RAMP N</b>	SHEET NO. 274
	TOTAL SHTS. 337



DRAFT

NOT FOR BIDDING

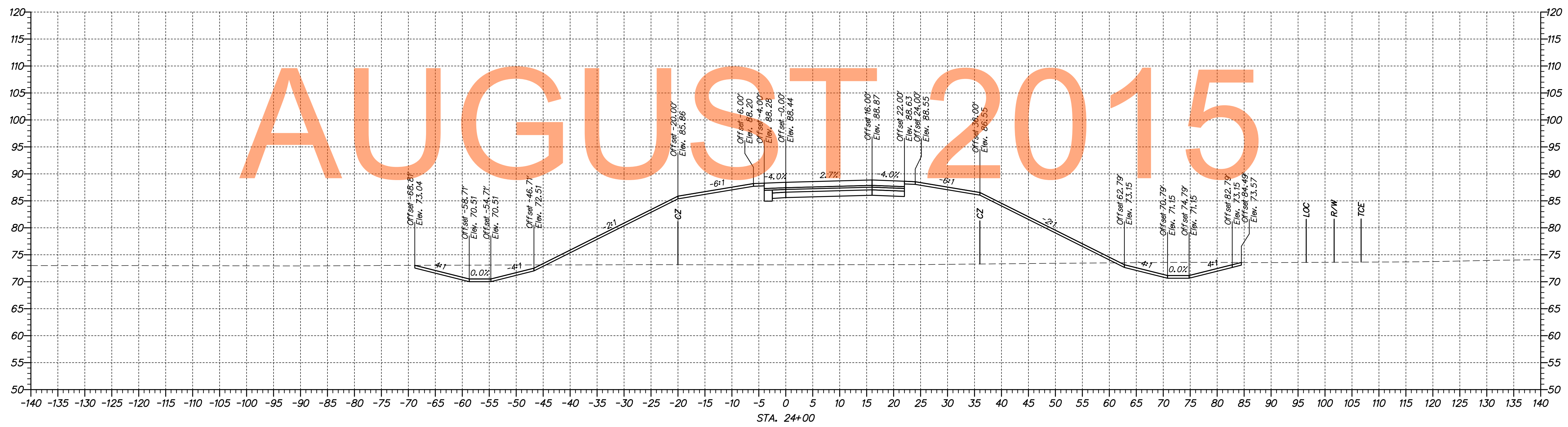
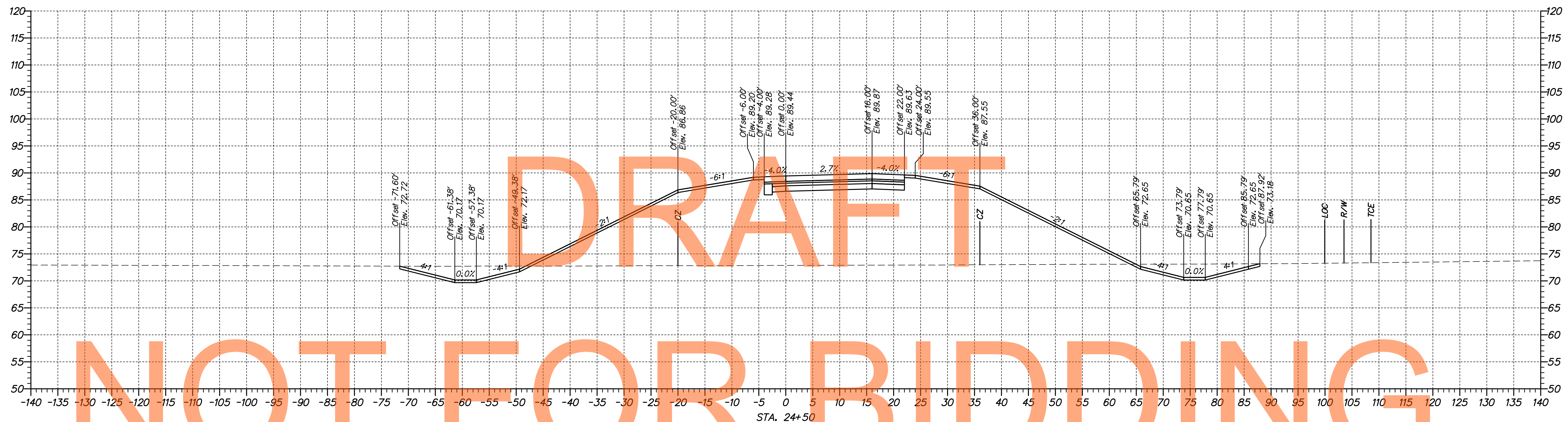

p:\1653-000\contract\1a\cadd\XS002\301\_1A\_Ramp\_N.dgn  
 08/30/2014 10:52:10 AM



ADDENDUMS / REVISIONS	

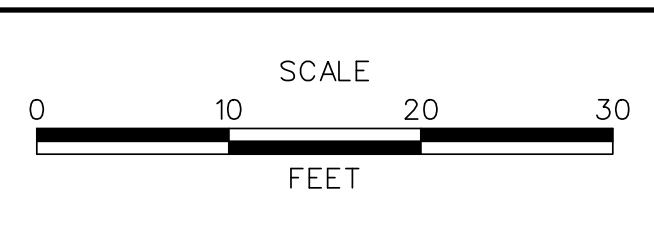

**US 301,  
SR 896 TO SR 1**

CONTRACT	BRIDGE NO.
T200911308	DESIGNED BY: MEF
COUNTY	CHECKED BY: TAO
NEW CASTLE	

<b>CROSS SECTIONS RAMP N</b>	SHEET NO.
	275
	TOTAL SHTS.
	337

DRAFT

NOT FOR BIDDING

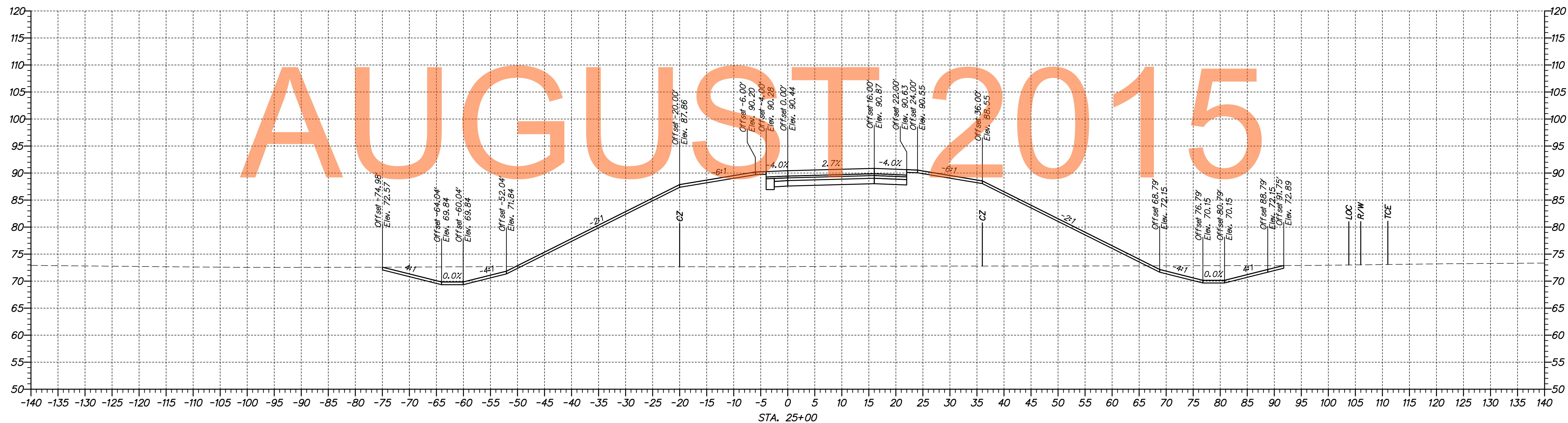
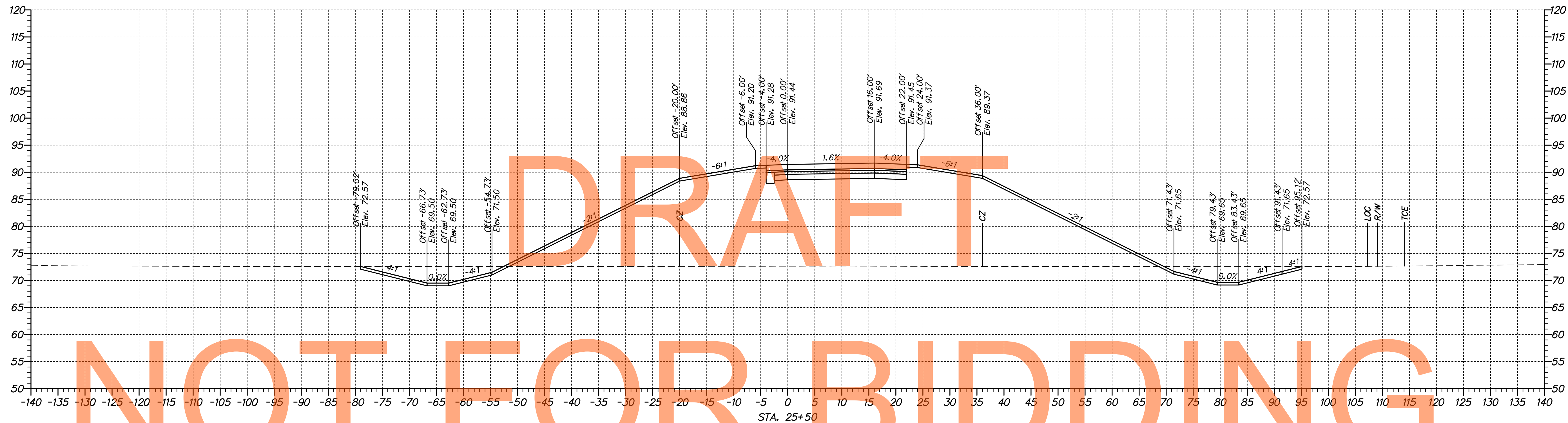

\\031653-000\con\project\1a\cadd\XS002\301\_1A\_Ramp\_N.dgn  
09/30/2014 10:52:12 AM

ADDENDUMS / REVISIONS	

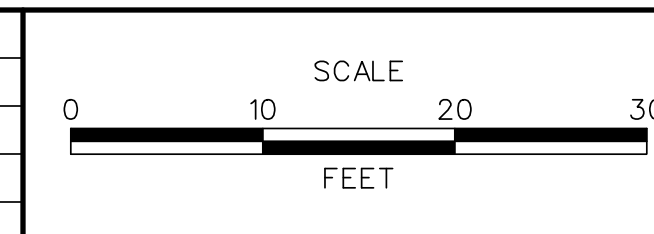

US 301,  
SR 896 TO SR 1

CONTRACT T200911308	BRIDGE NO. 
COUNTY NEW CASTLE	DESIGNED BY: MEF
	CHECKED BY: TAO

CROSS SECTIONS RAMP N	SHEET NO. 276
	TOTAL SHTS. 337

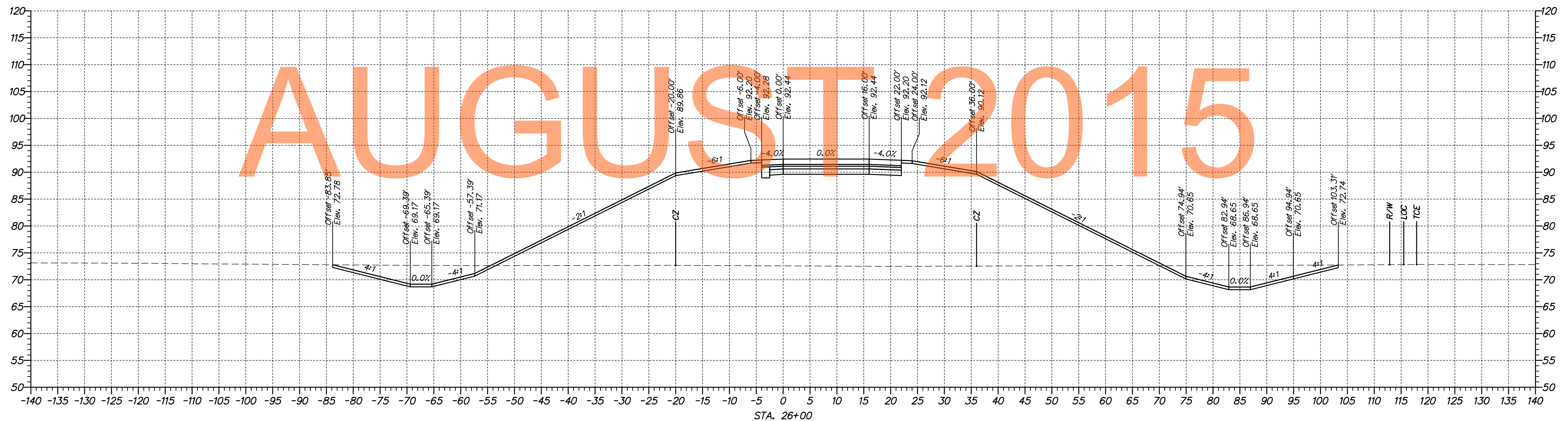
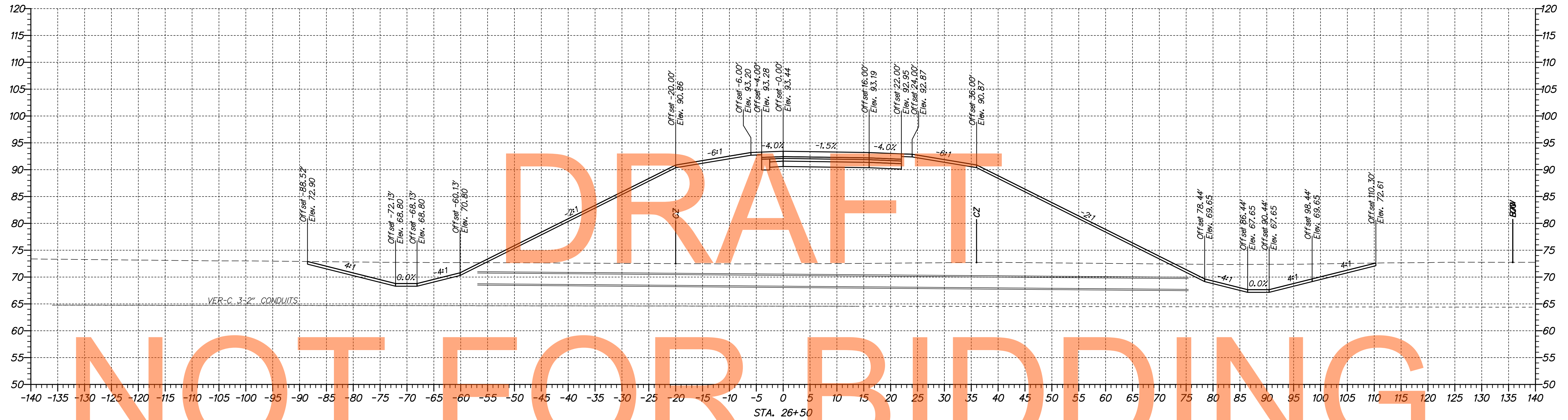

DRAFT

NOT FOR BIDDING

AUGUST 2015

MP: 3/16/13, 000, Contract 1A, CADD, V5002U301, 1A, Ramp, N.dgn  
 PL: 3/20/14, 12:29 PM



ADDENDUMS / REVISIONS	

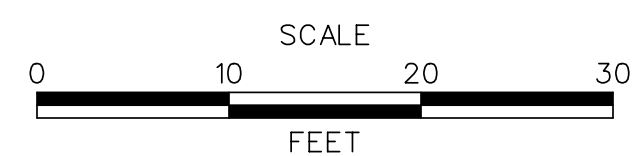

**US 301,  
SR 896 TO SR 1**

CONTRACT	BRIDGE NO.
T200911308	
COUNTY	DESIGNED BY: MEF
NEW CASTLE	CHECKED BY: TAO

**CROSS SECTIONS  
RAMP N**

SHEET NO.
277
TOTAL SHTS.
337

p:\1653-000\contract\1a\cadd\US301-1A\_Ramp\_M\_AET\_Sections.dgn  
 07/30/2014 10:52:16 AM

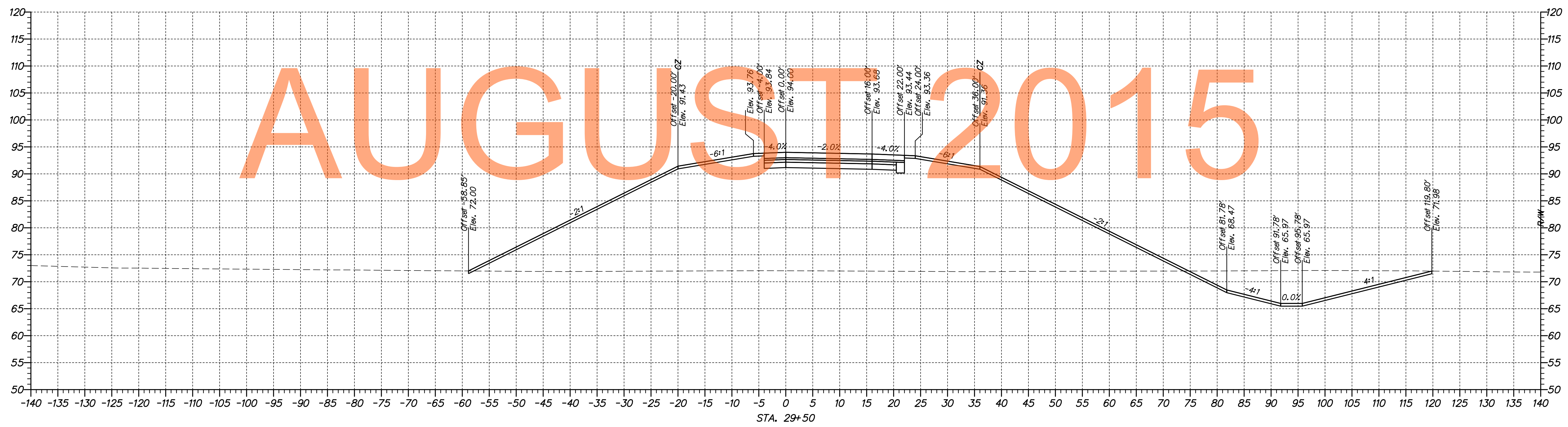
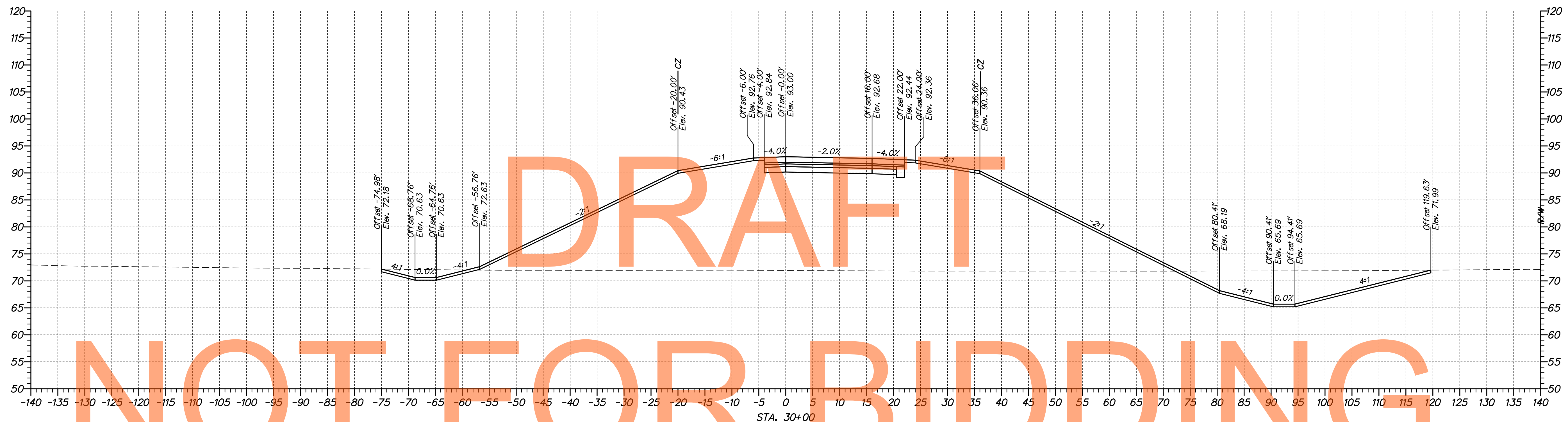

DRAFT

NOT FOR BIDDING

AUGUST 2015



ADDENDUMS / REVISIONS	

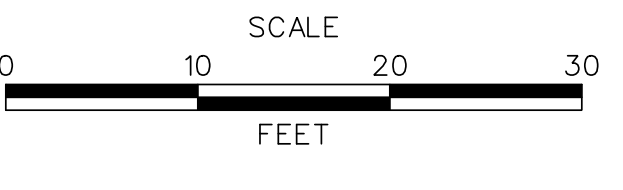

**US 301,  
SR 896 TO SR 1**

CONTRACT T200911308	BRIDGE NO.
COUNTY NEW CASTLE	DESIGNED BY: MEF
	CHECKED BY: TAO

**CROSS SECTIONS  
RAMP M**

SHEET NO. 278
TOTAL SHTS. 337

DRAFT

NOT FOR BIDDING

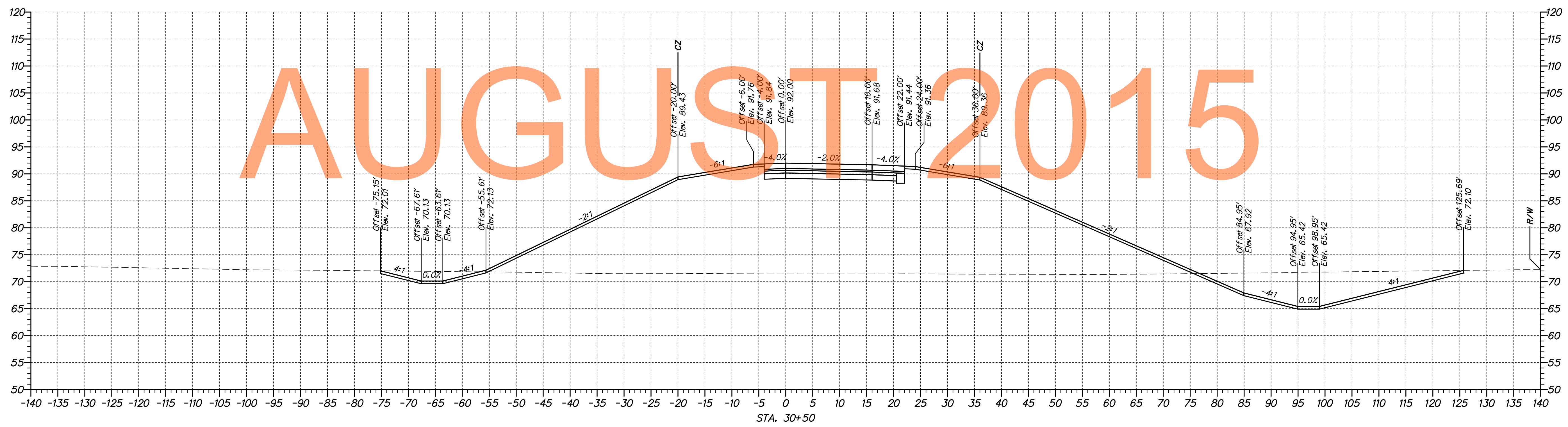
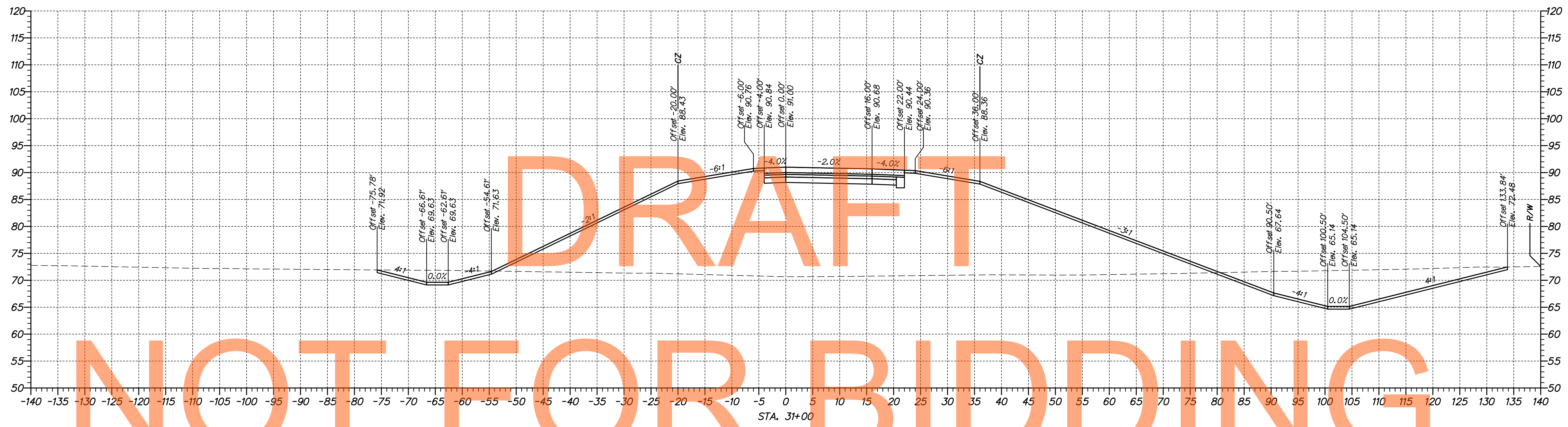

p:\1653-000\contract\1a\cadd\US301-1A\_Ramp\_M\_AET\_Sections.dgn  
 08/30/2014 10:52:16 AM



ADDENDUMS / REVISIONS	

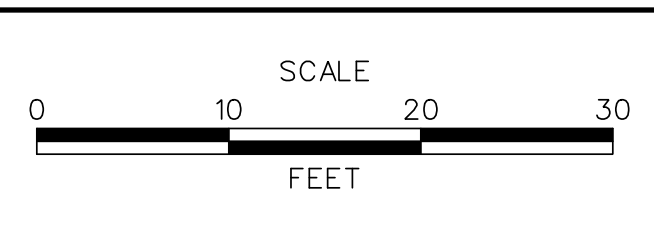

**US 301,  
SR 896 TO SR 1**

CONTRACT	BRIDGE NO.
T200911308	
COUNTY	DESIGNED BY: MEF
NEW CASTLE	CHECKED BY: TAO

<b>CROSS SECTIONS RAMP M</b>	SHEET NO.
	279
	TOTAL SHTS.
	337

nc:\653-000\contract\p\cadd\US301-IA\_Ramp\_M\_AET\_Sections.dgn  
 08/30/2014 10:52:52 AM

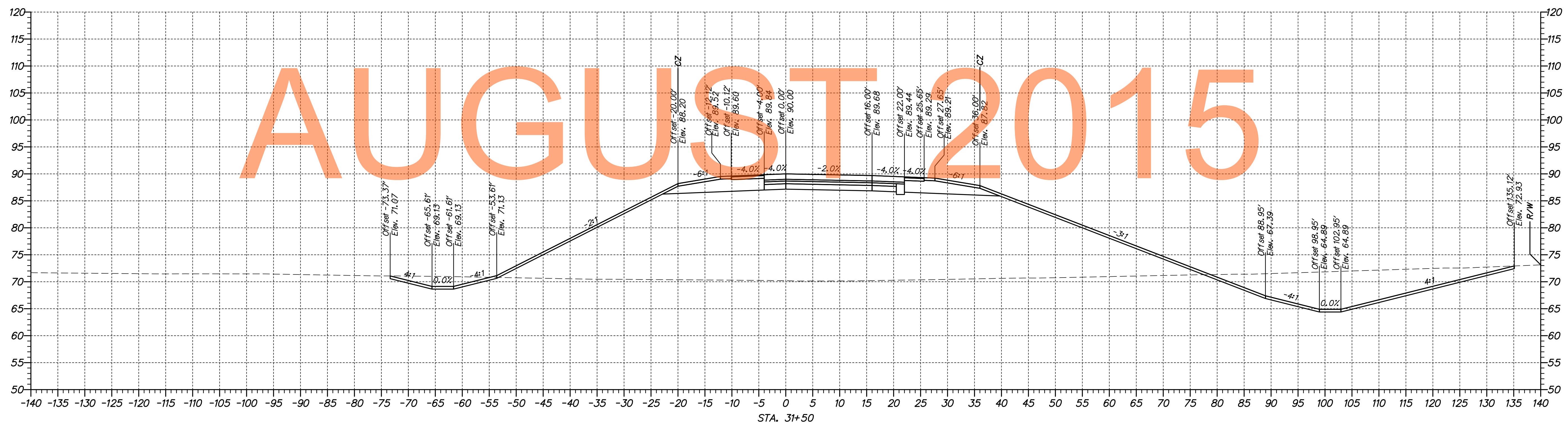
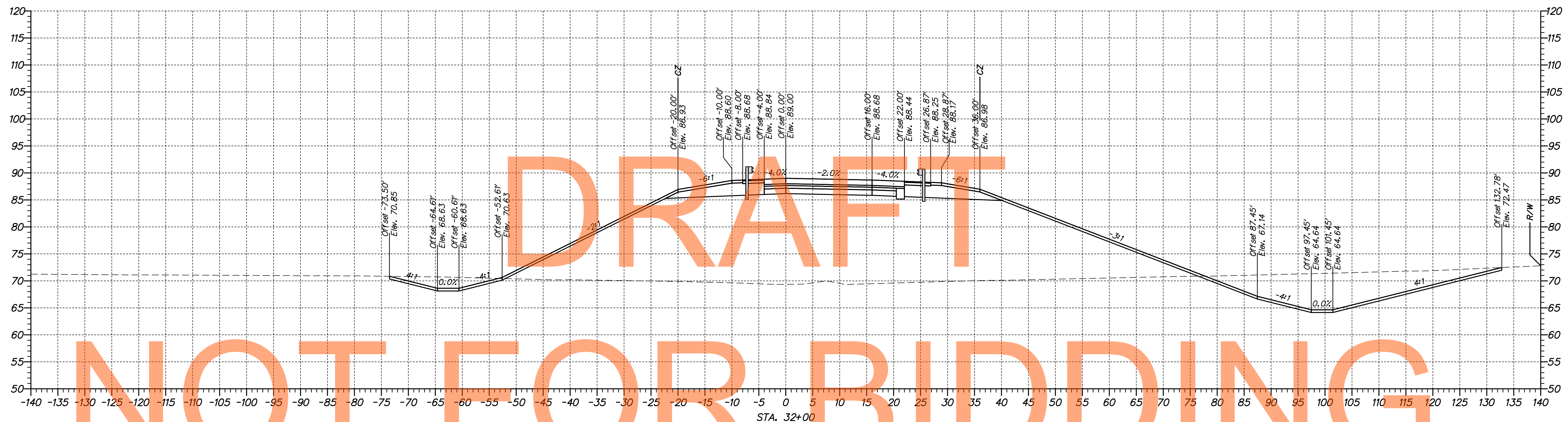

DRAFT

NOT FOR BIDDING

AUGUST 2015



ADDENDUMS / REVISIONS	

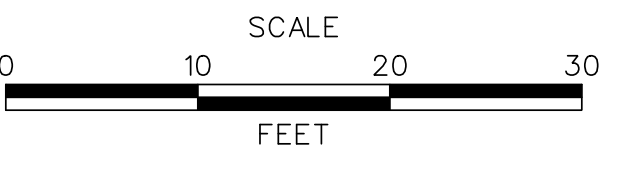

**US 301,  
SR 896 TO SR 1**

CONTRACT	BRIDGE NO.
T200911308	DESIGNED BY: MEF
COUNTY	CHECKED BY: TAO
NEW CASTLE	

<b>CROSS SECTIONS RAMP M</b>	SHEET NO. 280
	TOTAL SHTS. 337

\\03653-000\cadd\us301\_1A\_Ramp\_M\_AET\_Sections.dgn  
10/30/2014 10:52:22 AM

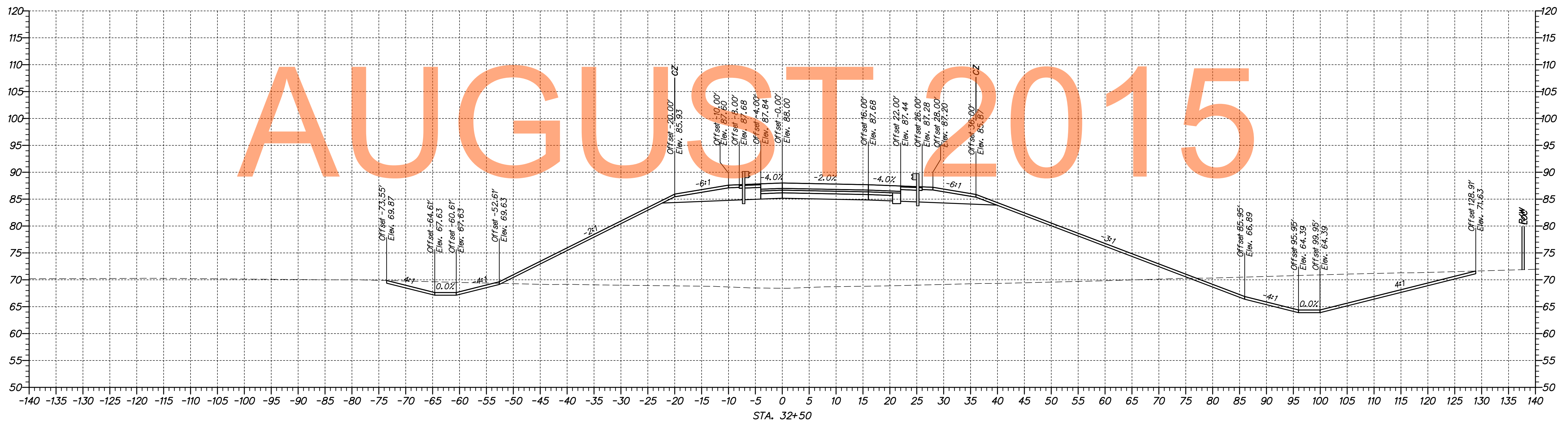
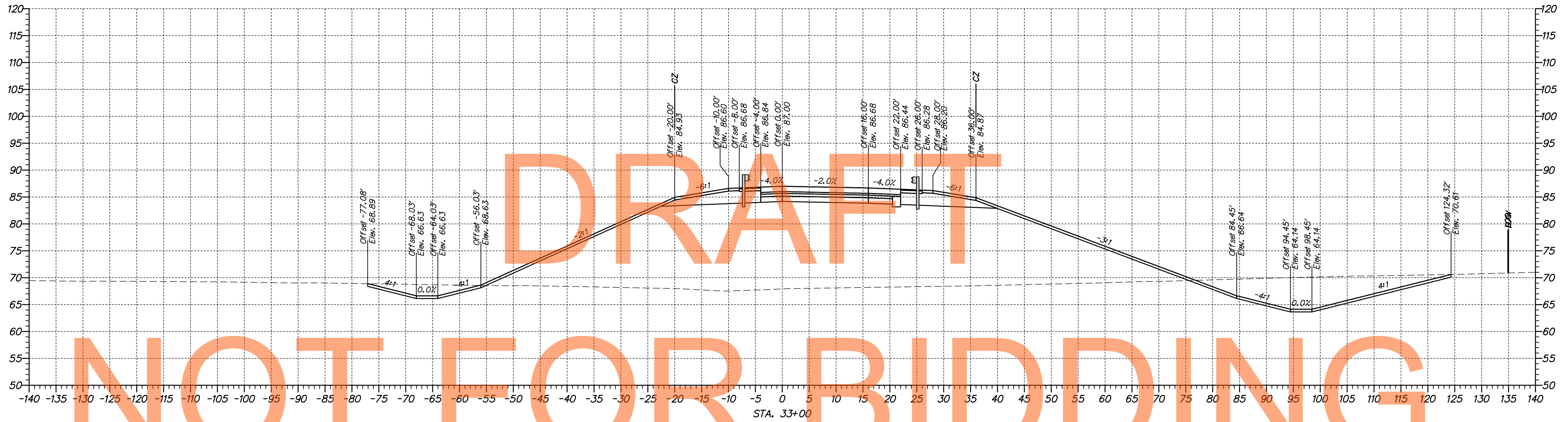

**NOT FOR BIDDING**

**AUGUST 2015**



ADDENDUMS / REVISIONS

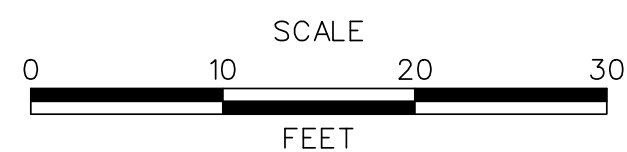

**US 301,  
SR 896 TO SR 1**

CONTRACT T200911308	BRIDGE NO.
COUNTY NEW CASTLE	DESIGNED BY: MEF
	CHECKED BY: TAO

**CROSS SECTIONS  
RAMP M**

SHEET NO. 281
TOTAL SHTS. 337

DRAFT

NOT FOR BIDDING

AUGUST 2015

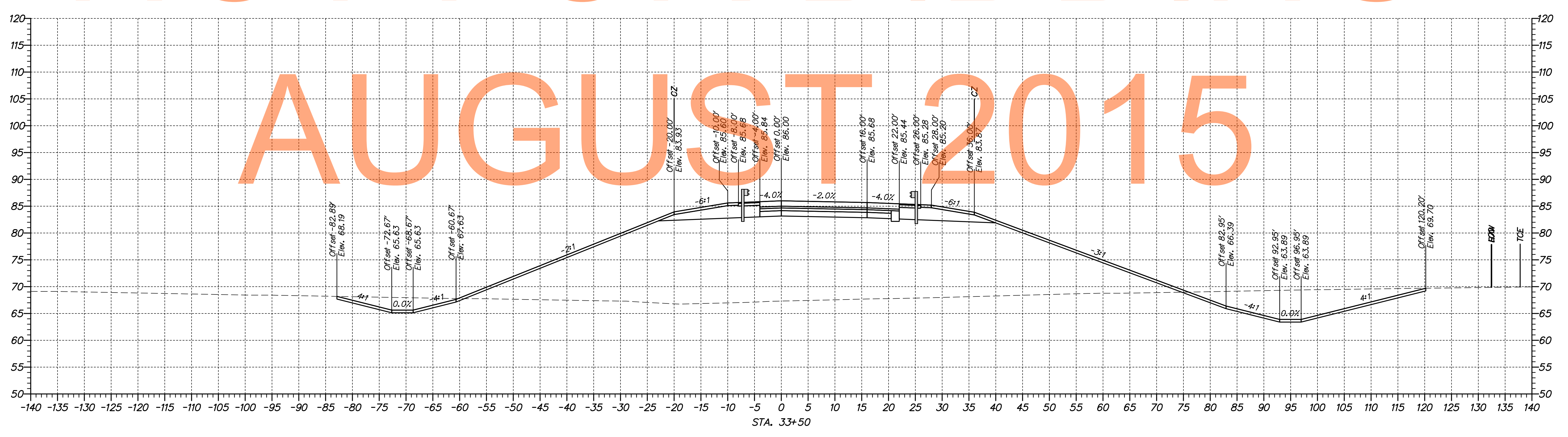
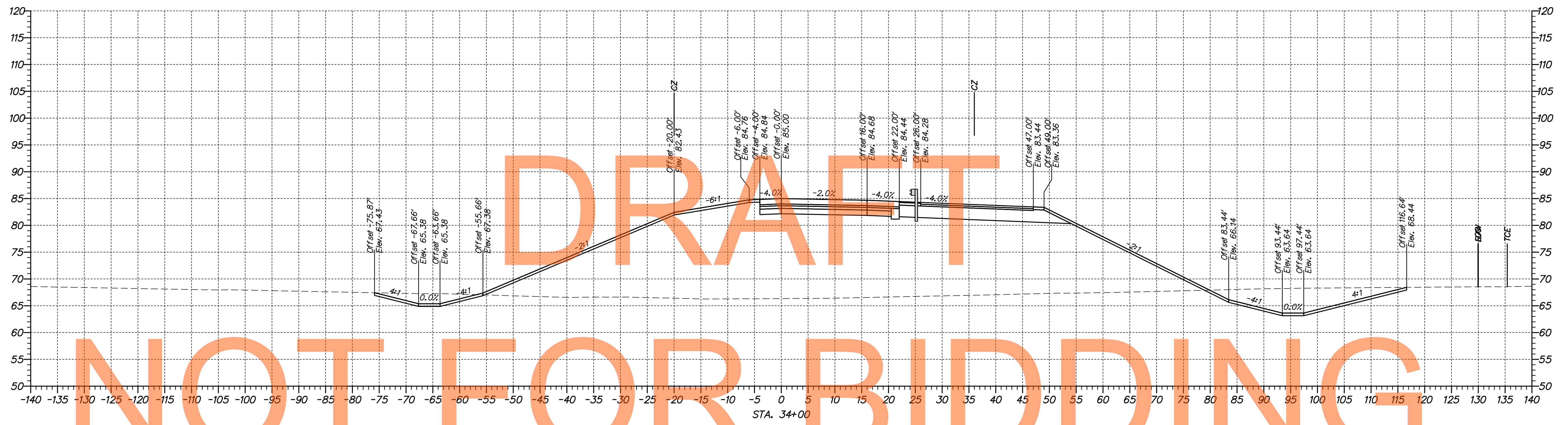

\\0653-000\cadd\US301\A\_Ramp\_M\_AET\_Sections.dgn 10/30/2014 10:52:52 AM



ADDENDUMS / REVISIONS	

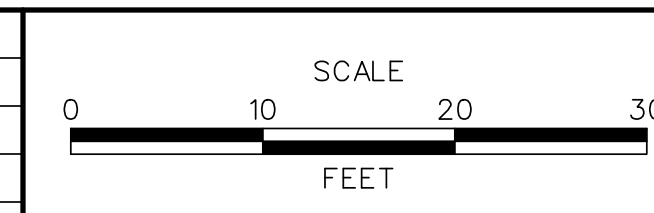

**US 301,  
SR 896 TO SR 1**

CONTRACT T200911308	BRIDGE NO.
COUNTY NEW CASTLE	DESIGNED BY: MEF
	CHECKED BY: TAO

<b>CROSS SECTIONS RAMP M</b>	SHEET NO. 282
	TOTAL SHTS. 337



\\0653-000\con\proj\1a\cadd\US301\_1A\_Ramp\_M\_AET\_Sections.dgn  
08/30/2014 10:52:32 AM



DELAWARE  
DEPARTMENT OF TRANSPORTATION

ADDENDUMS / REVISIONS

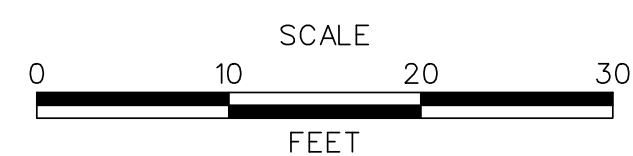

US 301,  
SR 896 TO SR 1

CONTRACT	BRIDGE NO.
T200911308	
COUNTY	DESIGNED BY: MEF
NEW CASTLE	CHECKED BY: TAO

CROSS SECTIONS  
RAMP M

SHEET NO.
283
TOTAL SHTS.
337

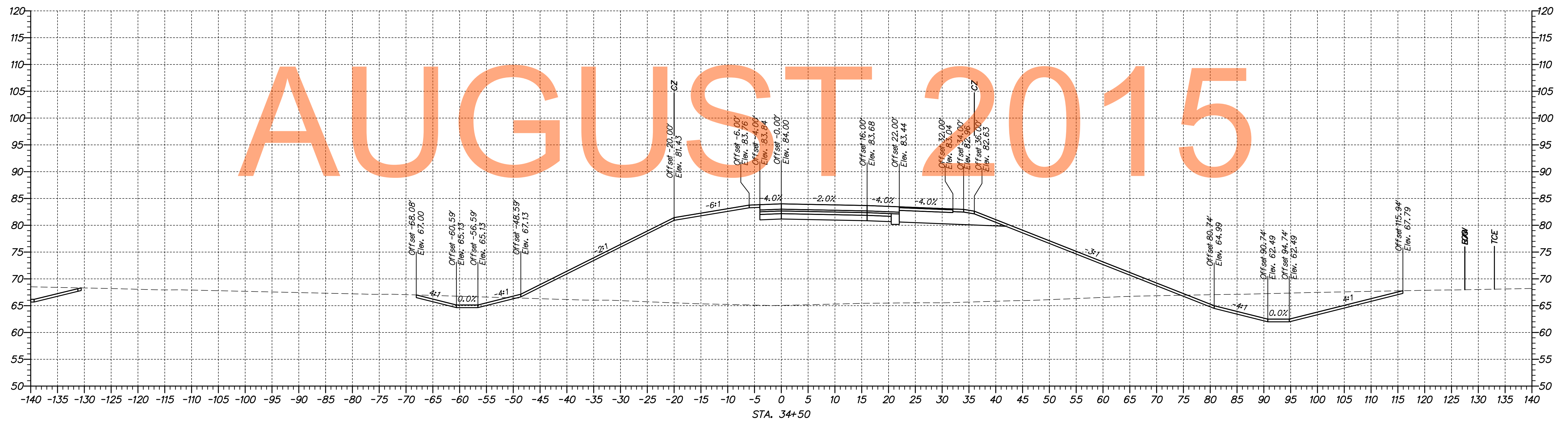
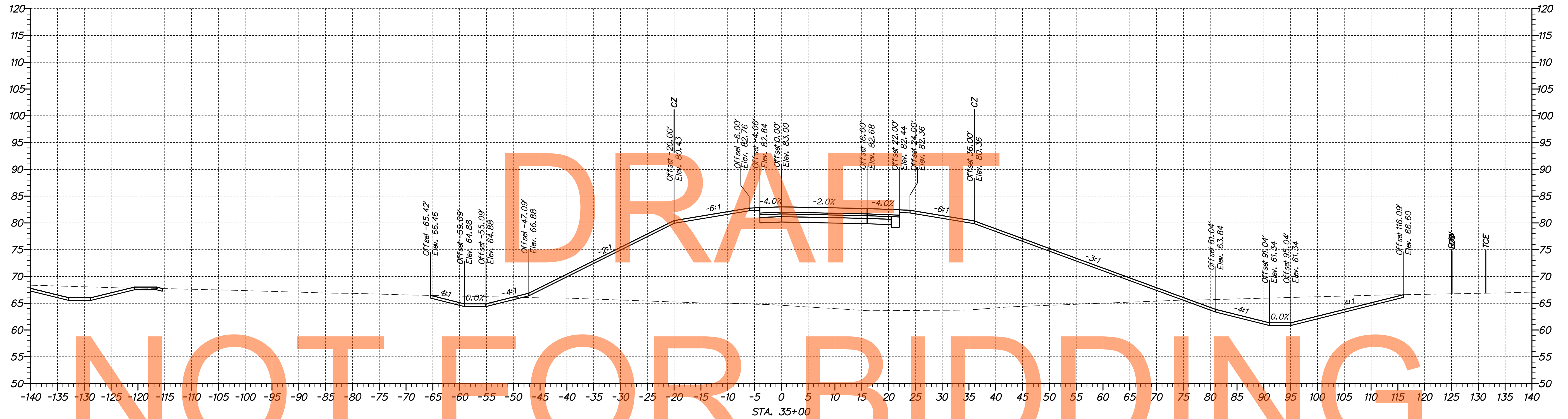

DRAFT  
NOT FOR BIDDING  
AUGUST 2015

n:\1653-000\com\refect\1a\cadd\US301\_1A\_Ramp\_M\_AET\_Sections.dgn  
 09/30/2014 10:52:52 AM

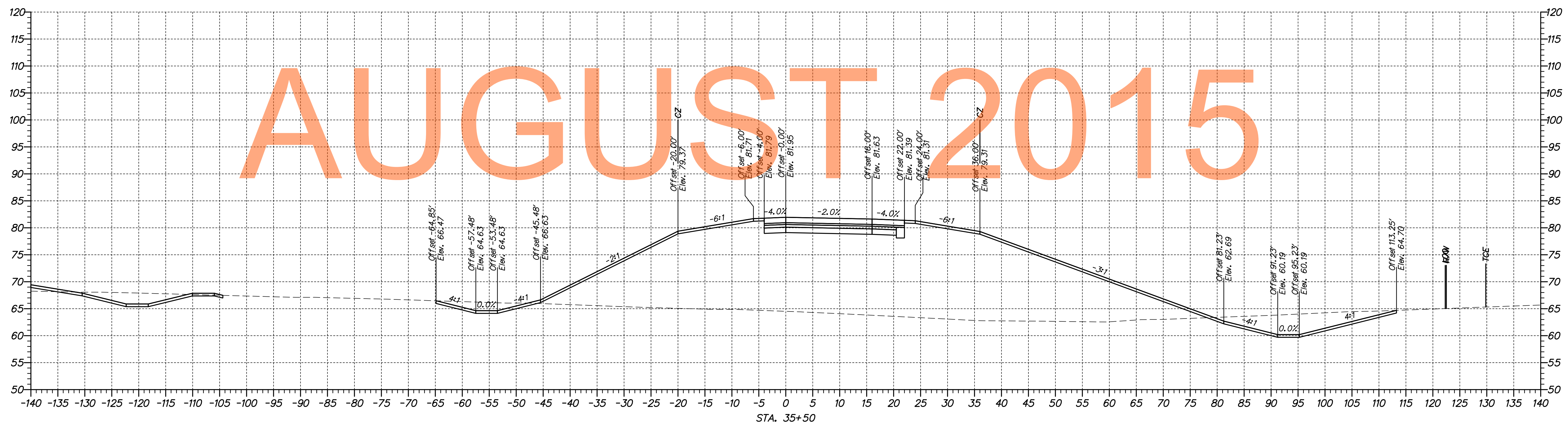
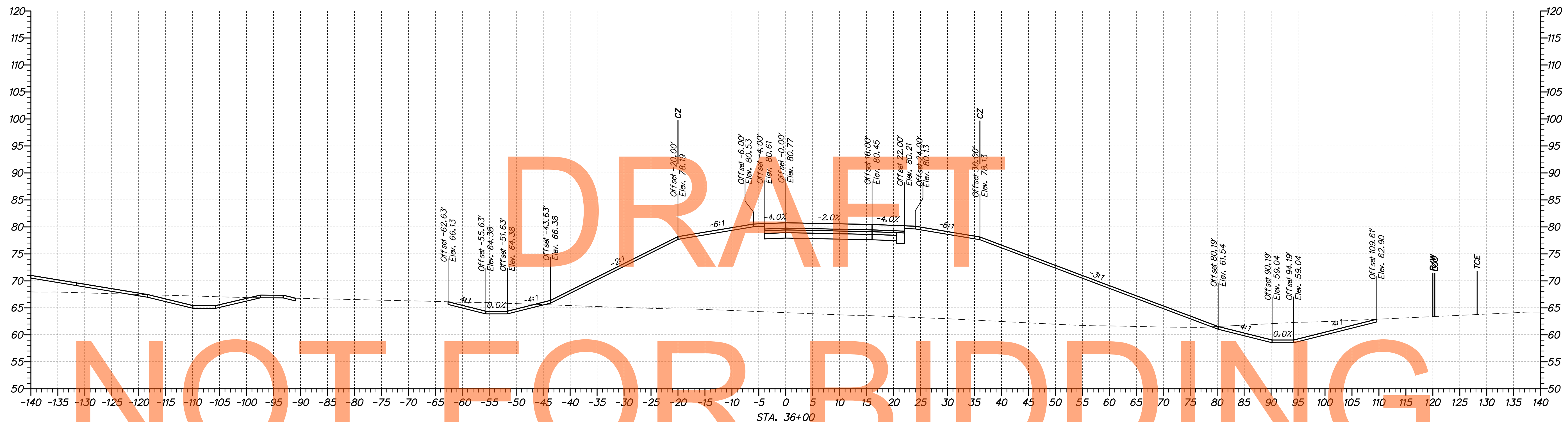

DRAFT  
 NOT FOR BIDDING  
 AUGUST 2015



ADDENDUMS / REVISIONS	

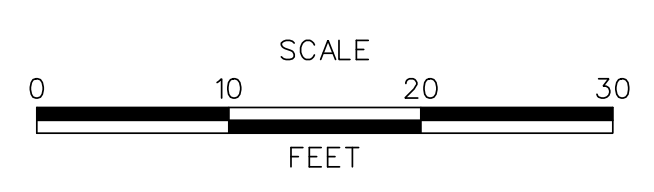

**US 301,**  
**SR 896 TO SR 1**

CONTRACT	BRIDGE NO.
T200911308	DESIGNED BY: MEF
COUNTY	CHECKED BY: TAO
NEW CASTLE	

**CROSS SECTIONS**  
**RAMP M**

SHEET NO.
284
TOTAL SHTS.
337

DRAFT

NOT FOR BIDDING

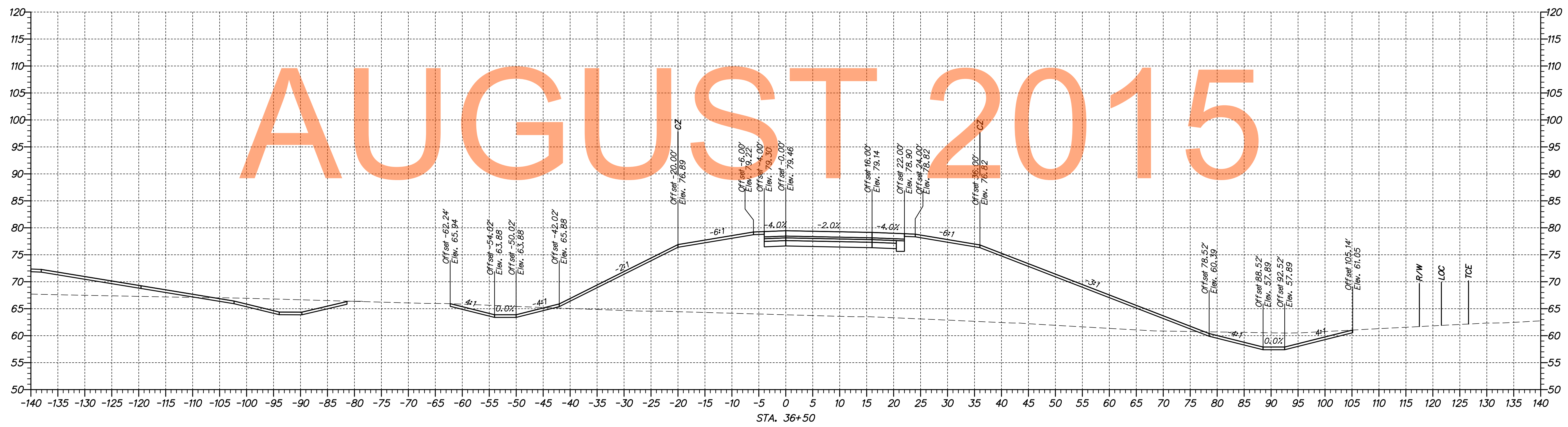
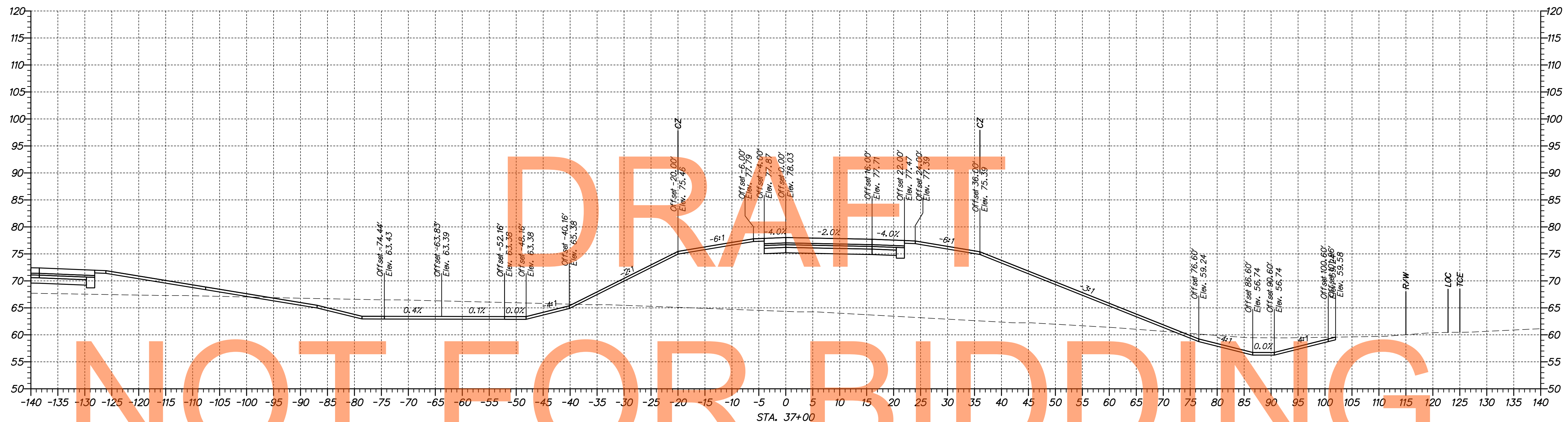

p:\1653-000\sect\ref\1a\cadd\US301\_1A\_Ramp\_M\_AET\_Section.dgn  
 08/30/2014 10:52:50 AM



ADDENDUMS / REVISIONS	

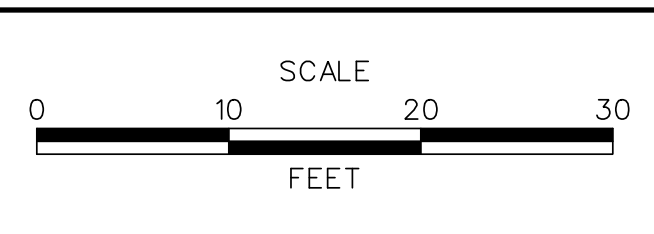

**US 301,  
SR 896 TO SR 1**

CONTRACT	BRIDGE NO.
T200911308	
COUNTY	DESIGNED BY: MEF
NEW CASTLE	CHECKED BY: TAO

<b>CROSS SECTIONS RAMP M</b>	SHEET NO.
	285
	TOTAL SHTS.
	337

DRAFT

NOT FOR BIDDING

AUGUST 2015

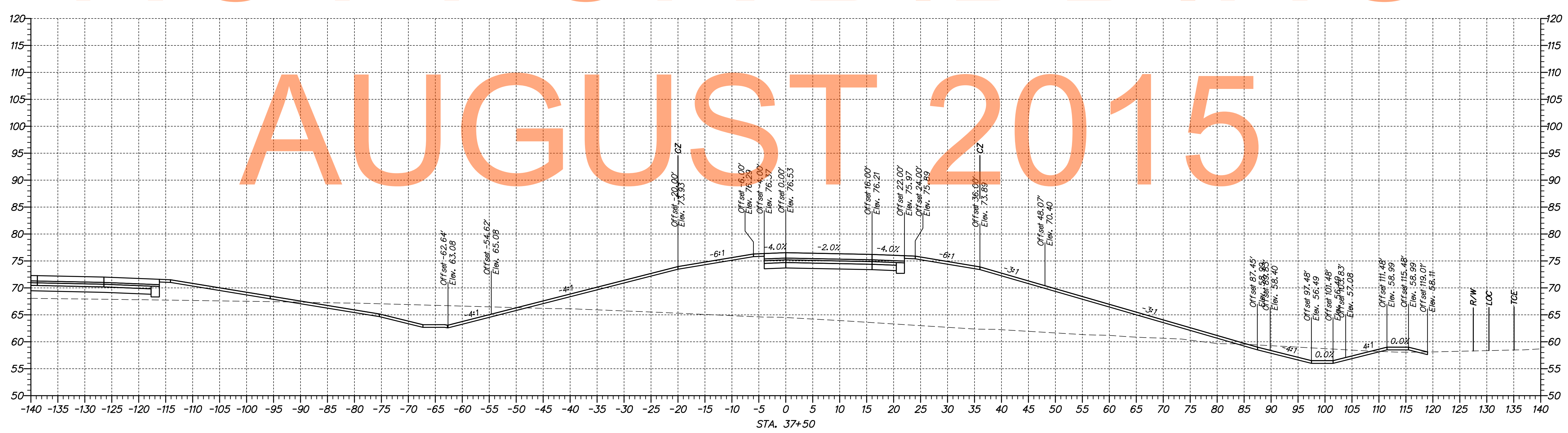
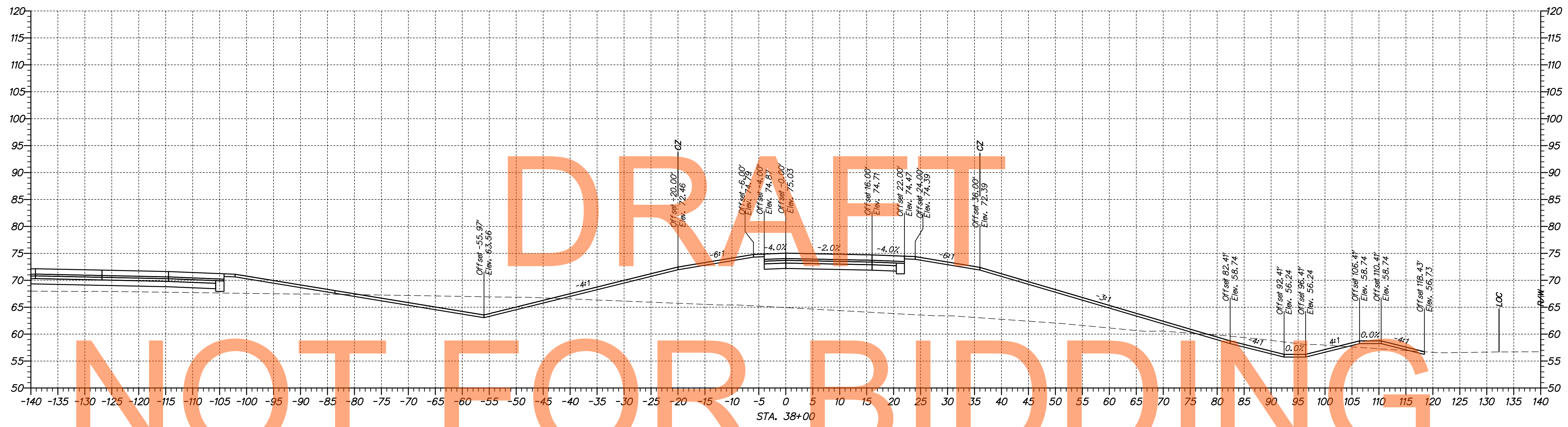

\\0653-000\cadd\US301\_IA\_Ramp\_M\_AET\_Sections.dgn 10/30/2014 10:52:53 AM



ADDENDUMS / REVISIONS	

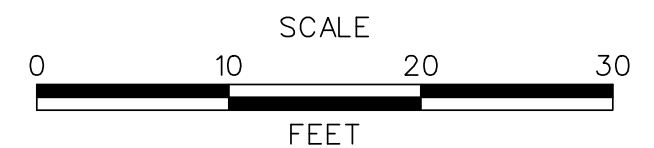

US 301, SR 896 TO SR 1

CONTRACT	BRIDGE NO.
T200911308	
COUNTY	DESIGNED BY: MEF
NEW CASTLE	CHECKED BY: TAO

CROSS SECTIONS RAMP M

SHEET NO.
286
TOTAL SHTS.
337

DRAFT

NOT FOR BIDDING

AUGUST 2015

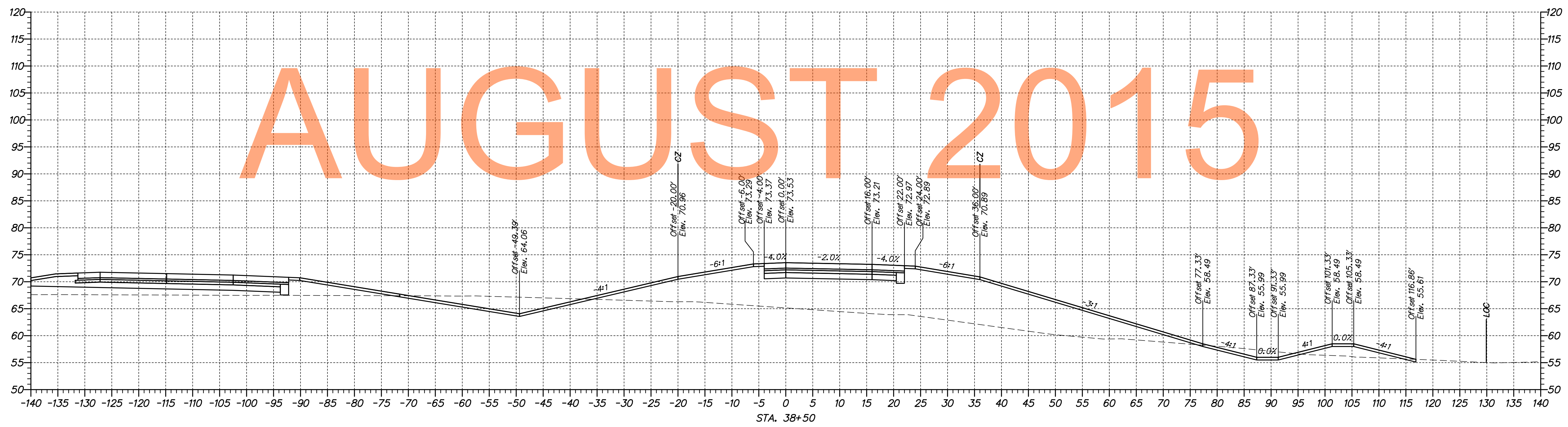
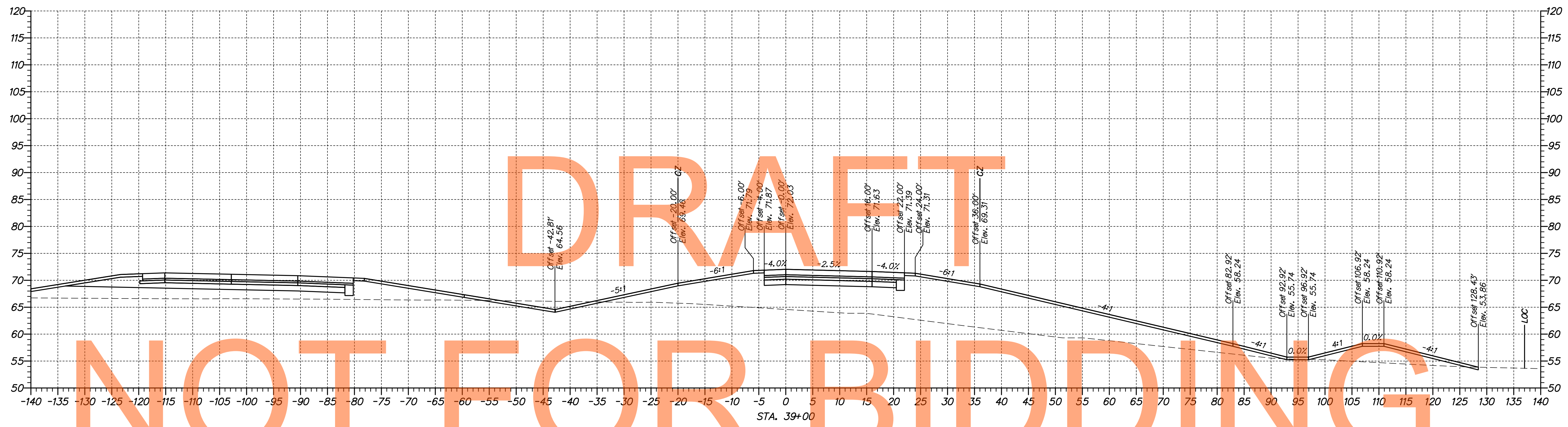

p:\1653-000\contract\p\cadd\US301-IA\_Ramp\_M\_AET\_Sections.dgn  
 08/30/2014 10:52:54 AM



ADDENDUMS / REVISIONS	

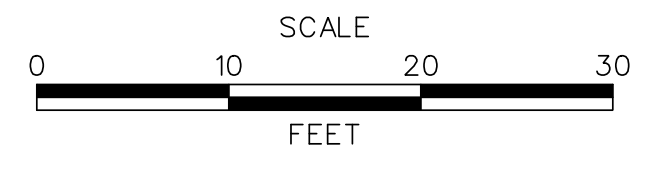

**US 301,  
SR 896 TO SR 1**

CONTRACT	BRIDGE NO.
T200911308	
COUNTY	DESIGNED BY: MEF
NEW CASTLE	CHECKED BY: TAO

**CROSS SECTIONS  
RAMP M**

SHEET NO.
287
TOTAL SHTS.
337

DRAFT

NOT FOR BIDDING

AUGUST 2015

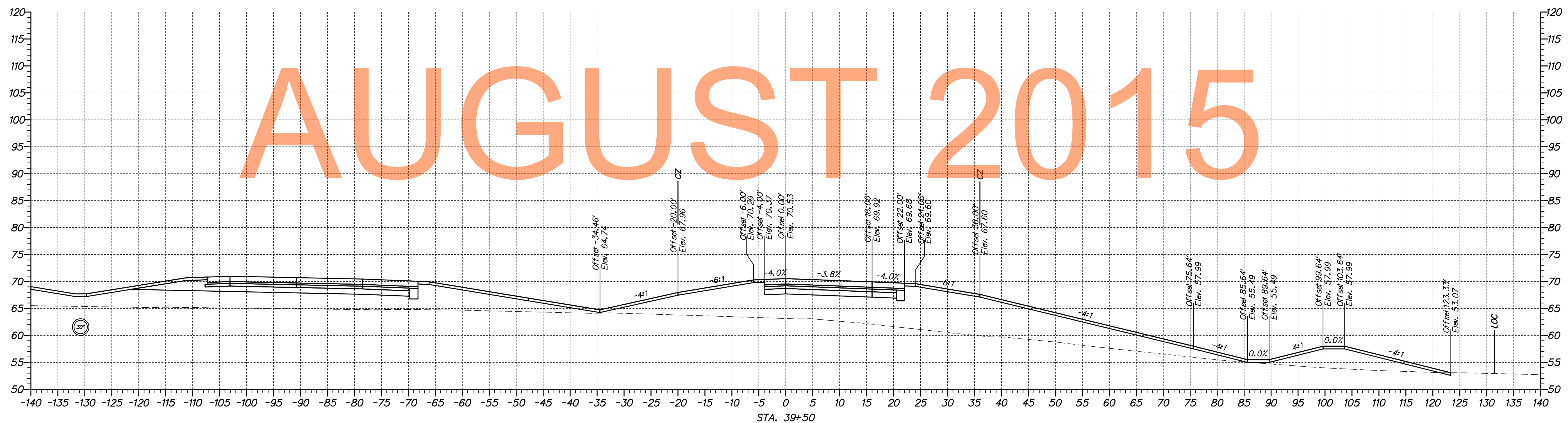
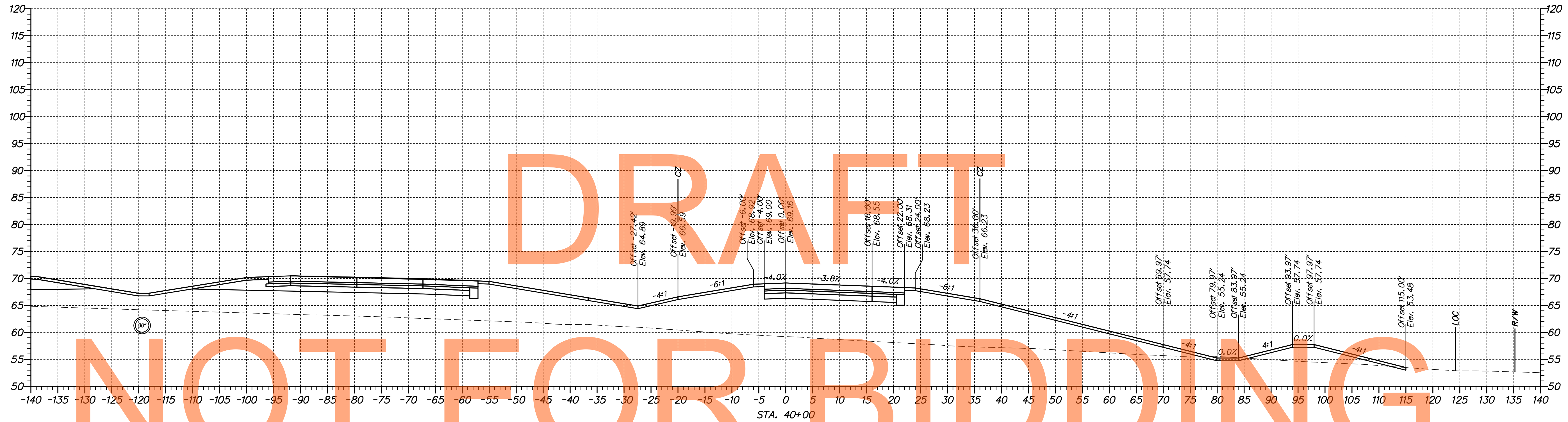

\\1653-000\con\trac\1a\cadd\US301-1A\_Ramp\_M\_AET\_Sections.dgn 10/30/2014 10:23:59 AM



ADDENDUMS / REVISIONS	

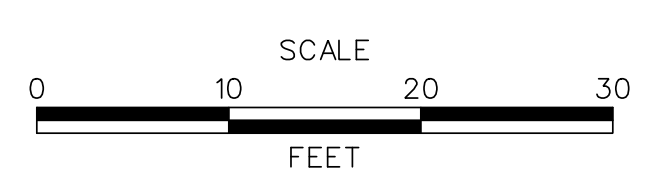

US 301, SR 896 TO SR 1

CONTRACT	BRIDGE NO.
T200911308	
COUNTY	DESIGNED BY: MEF
NEW CASTLE	CHECKED BY: TAO

CROSS SECTIONS RAMP M

SHEET NO.
288
TOTAL SHTS.
337

DRAFT

NOT FOR BIDDING

AUGUST 2015

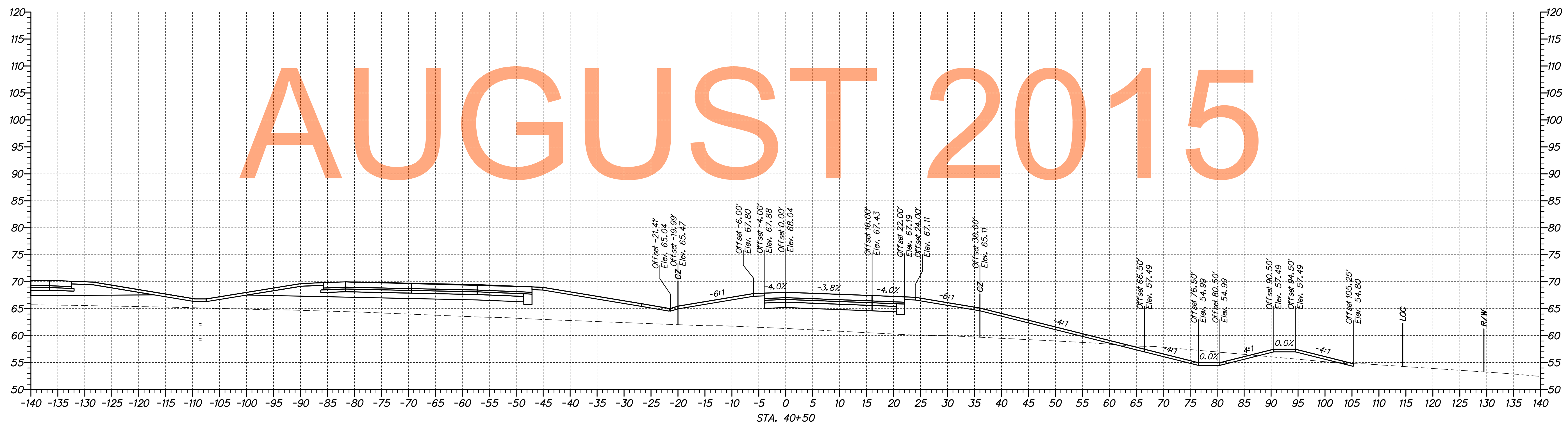
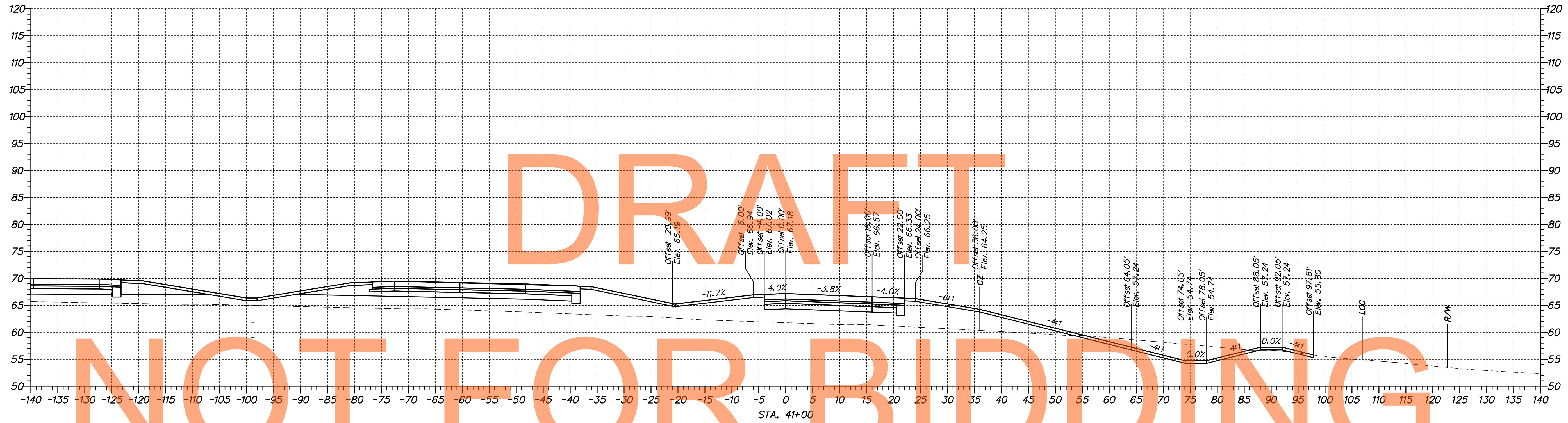

nc:\1653-000\sect\sect\1a\cadd\US301\_1A\_Ramp\_M\_AET\_Sections.dgn  
07/30/2014 10:52:59 AM



ADDENDUMS / REVISIONS	

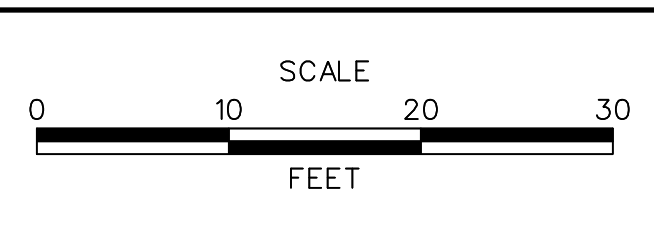

**US 301,  
SR 896 TO SR 1**

CONTRACT T200911308	BRIDGE NO.
COUNTY NEW CASTLE	DESIGNED BY: MEF
	CHECKED BY: TAO

<b>CROSS SECTIONS RAMP M</b>
SHEET NO. 289
TOTAL SHTS. 337

DRAFT

NOT FOR BIDDING

AUGUST 2015

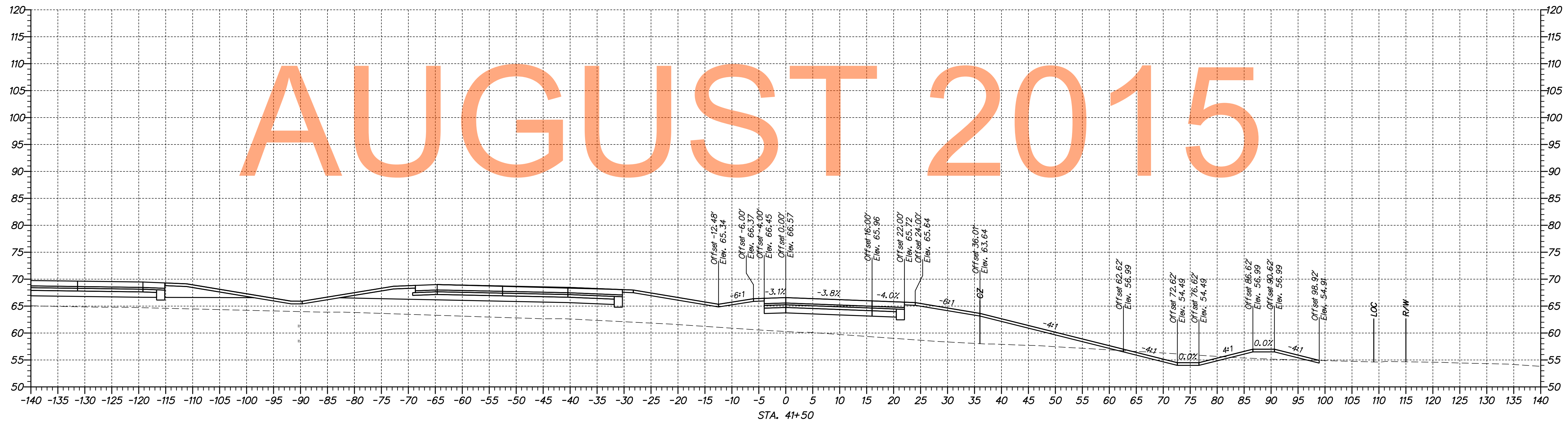
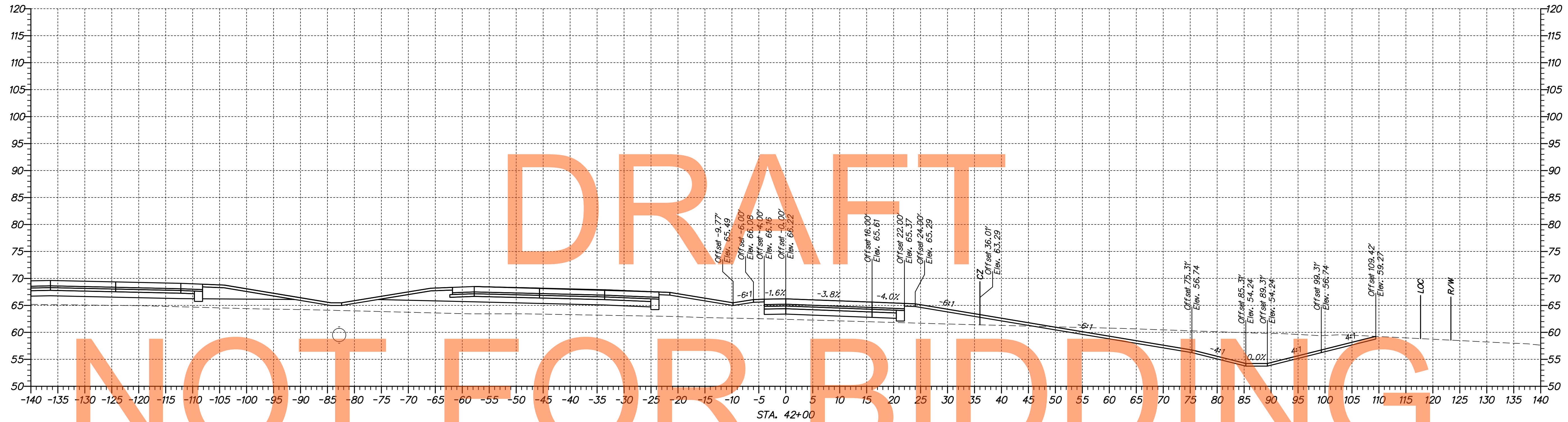

nc:\653-000\com\refect\p\cadd\US301-IA\_Ramp\_M\_AET\_Sections.dgn  
07/30/2014 10:25:49 AM



ADDENDUMS / REVISIONS	

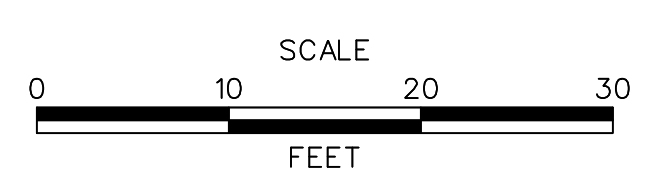

US 301,  
SR 896 TO SR 1

CONTRACT T200911308	BRIDGE NO.
COUNTY NEW CASTLE	DESIGNED BY: MEF
	CHECKED BY: TAO

CROSS SECTIONS  
RAMP M

SHEET NO. 290
TOTAL SHTS. 337



DRAFT

NOT FOR BIDDING

AUGUST 2015

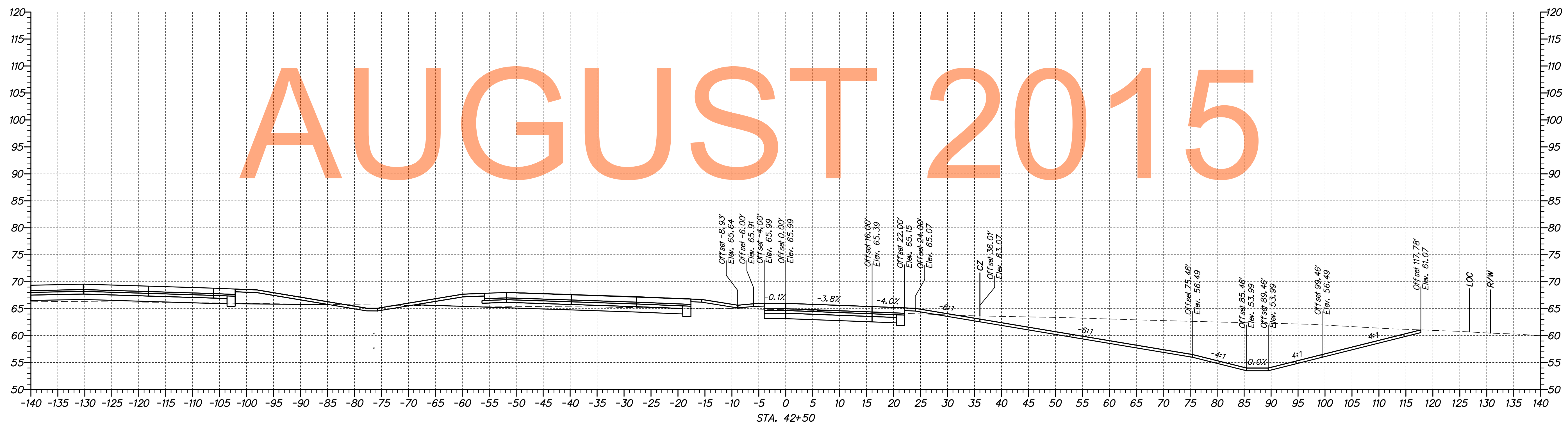
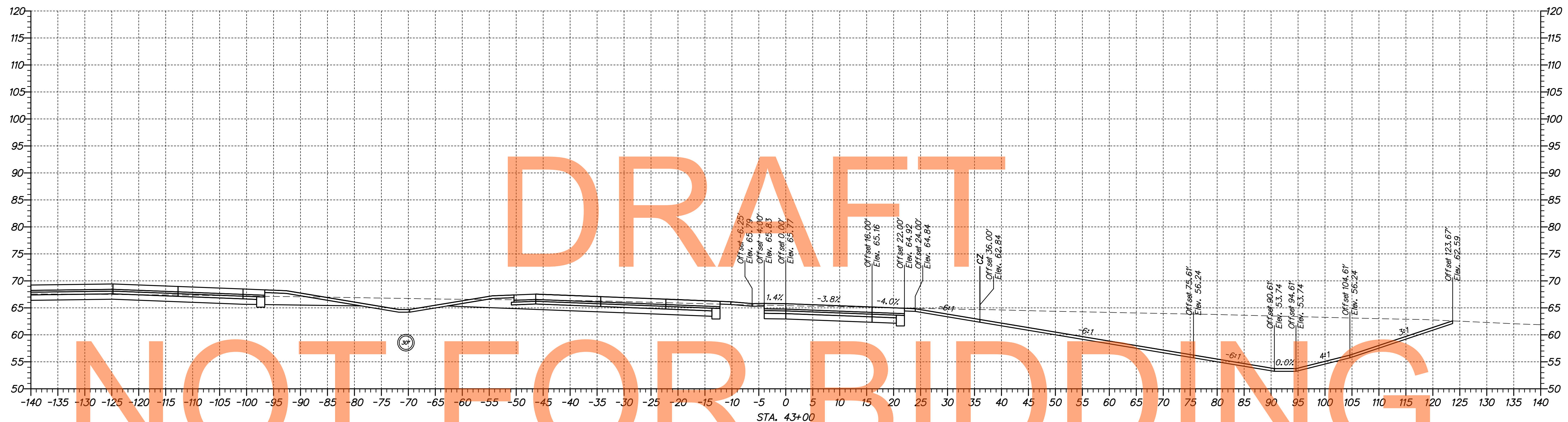

nc:\653-000\com\refect\p\cadd\US301-IA\_Ramp\_M\_AET\_Sections.dgn  
07/30/2014 10:52:42 AM



ADDENDUMS / REVISIONS	

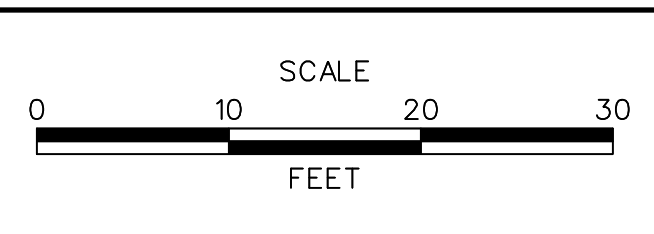

US 301,  
SR 896 TO SR 1

CONTRACT T200911308	BRIDGE NO.
COUNTY NEW CASTLE	DESIGNED BY: MEF
	CHECKED BY: TAO

CROSS SECTIONS RAMP M	SHEET NO. 291
	TOTAL SHTS. 337

DRAFT

NOT FOR BIDDING

AUGUST 2015

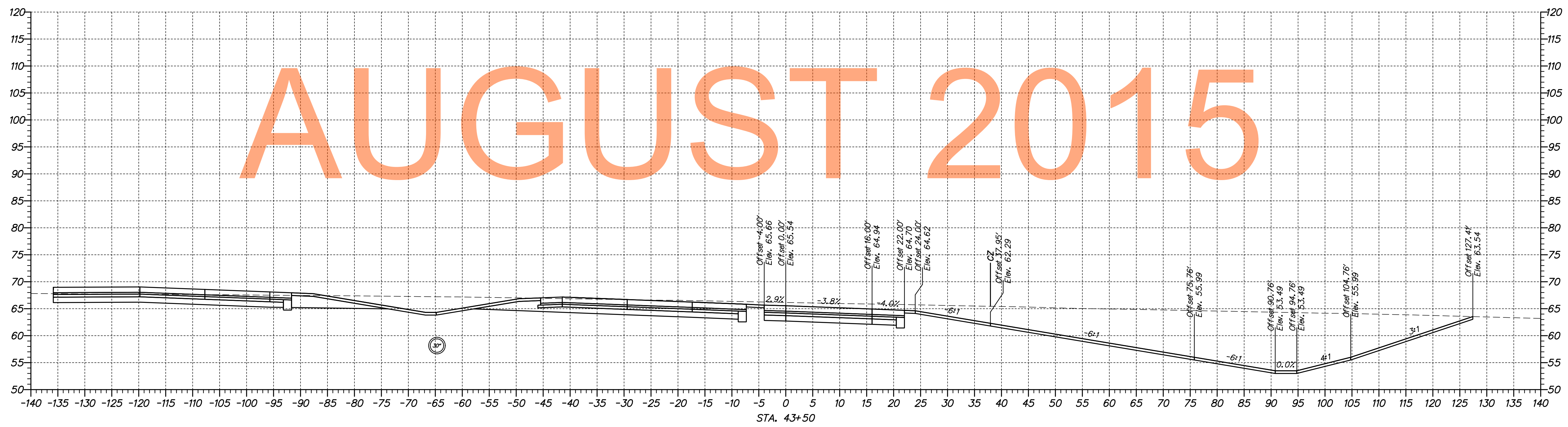
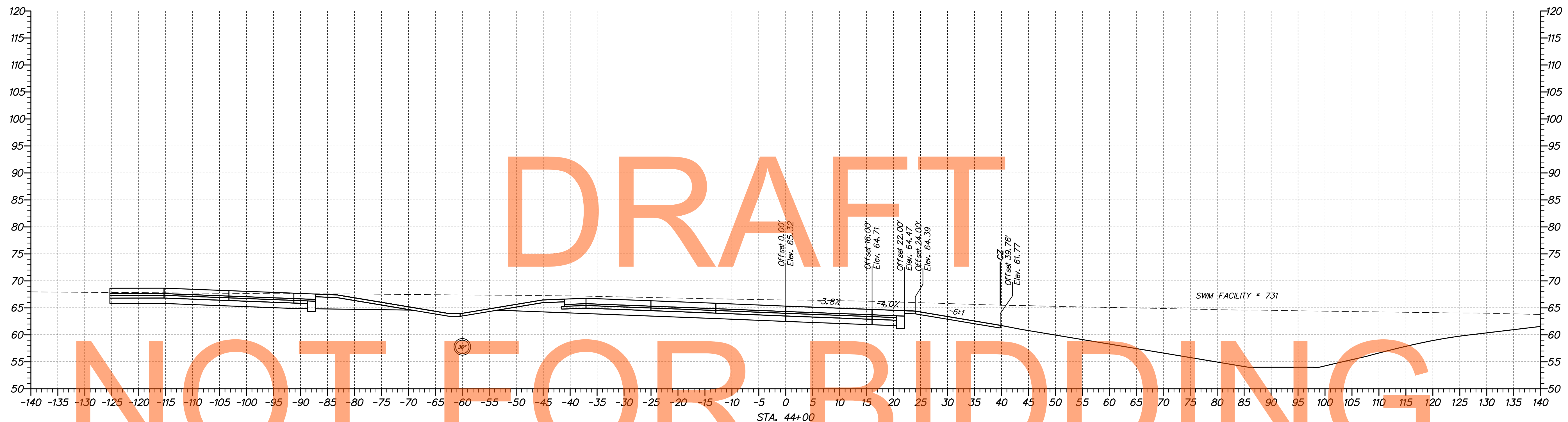

nc:\653-000\contract\p\cadd\US301-IA-Ramp-M AET Sections.dgn  
07/30/2014 10:23:44 AM



ADDENDUMS / REVISIONS	

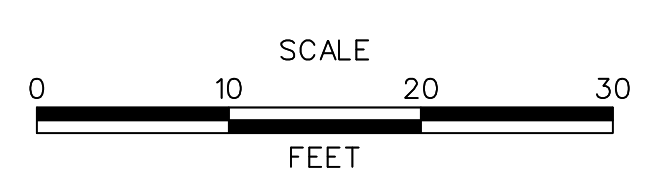

US 301,  
SR 896 TO SR 1

CONTRACT T200911308	BRIDGE NO.
COUNTY NEW CASTLE	DESIGNED BY: MEF
	CHECKED BY: TAO

CROSS SECTIONS  
RAMP M

SHEET NO. 292
TOTAL SHTS. 337

DRAFT

NOT FOR BIDDING

AUGUST 2015

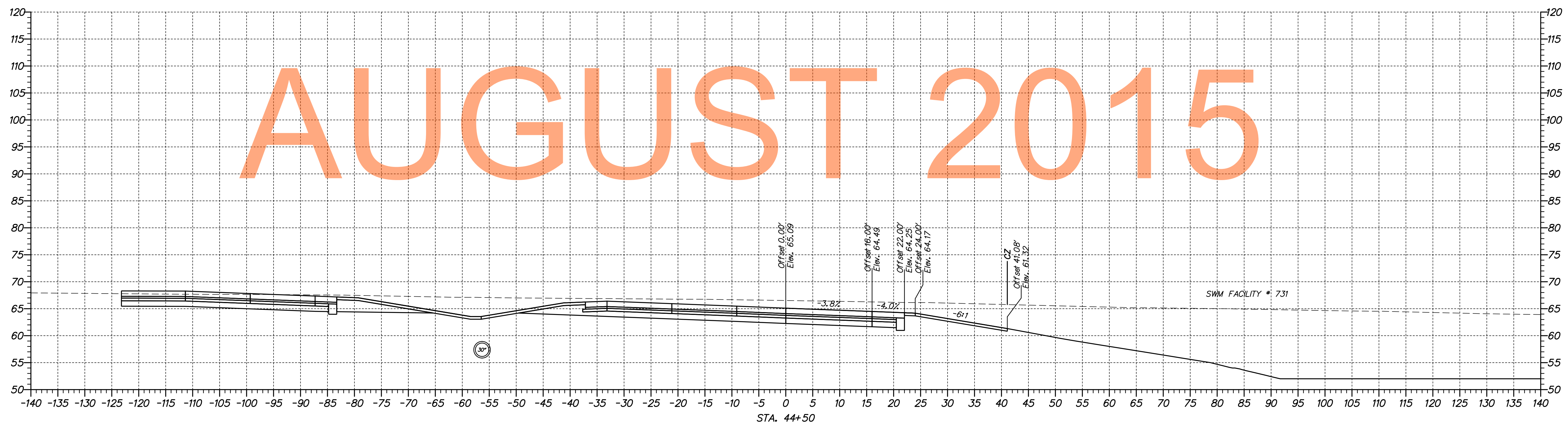
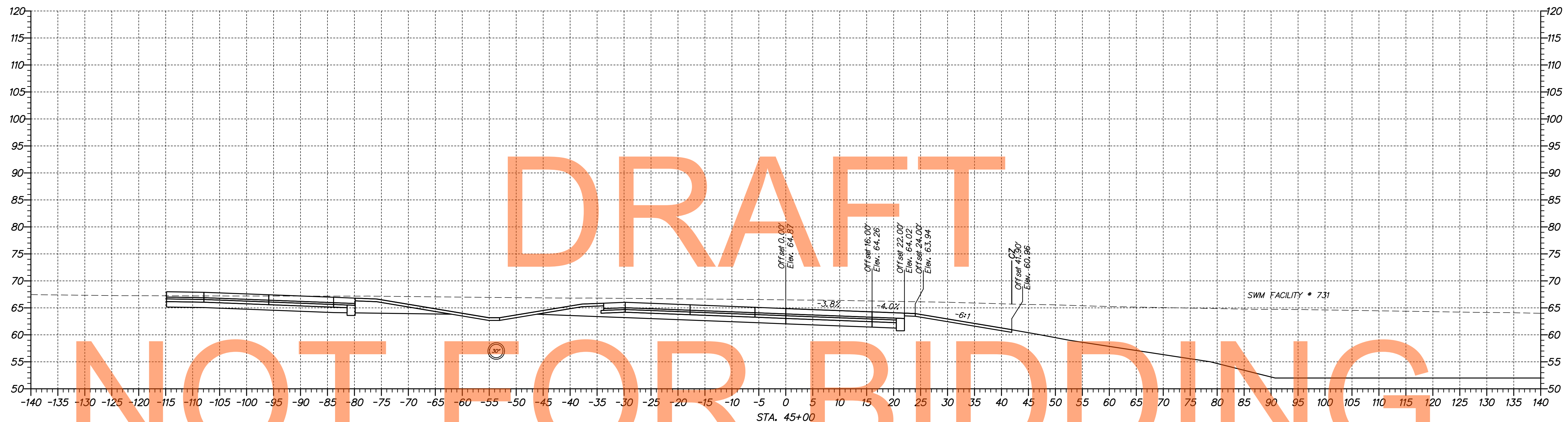

nc:\653-000\con\raet\ra\caad\US301-1A\_Ramp\_M\_AET\_Sections.dgn 10/30/2014 10:52:46 AM



ADDENDUMS / REVISIONS	

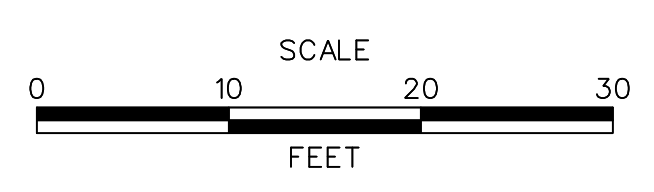

US 301, SR 896 TO SR 1

CONTRACT	BRIDGE NO.
T200911308	DESIGNED BY: MEF
COUNTY	CHECKED BY: TAO
NEW CASTLE	

CROSS SECTIONS RAMP M

SHEET NO.
293
TOTAL SHTS.
337

DRAFT

NOT FOR BIDDING

AUGUST 2015

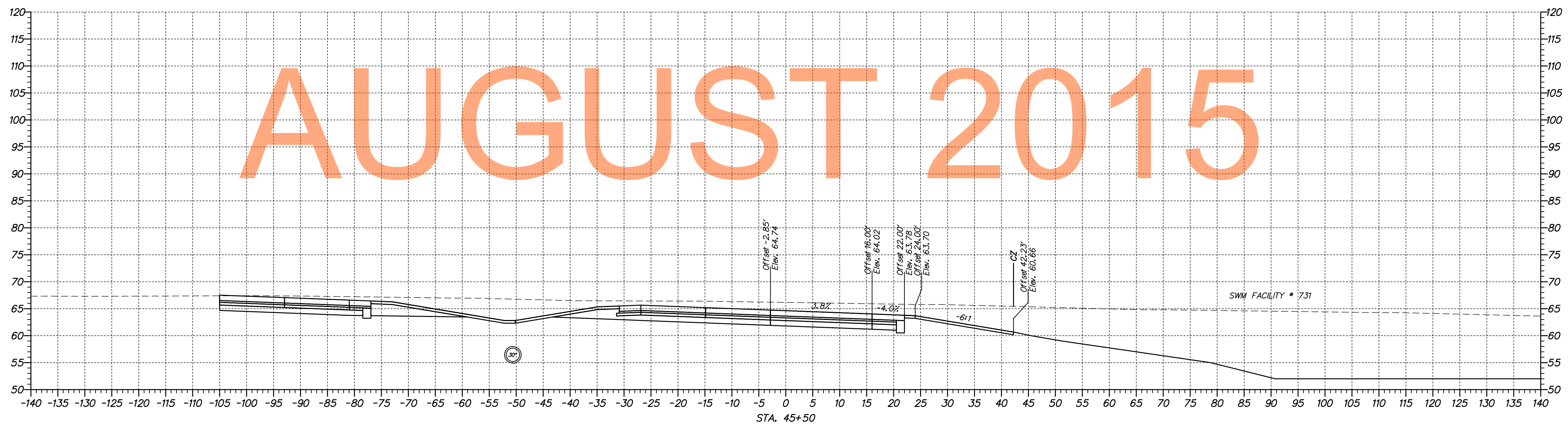
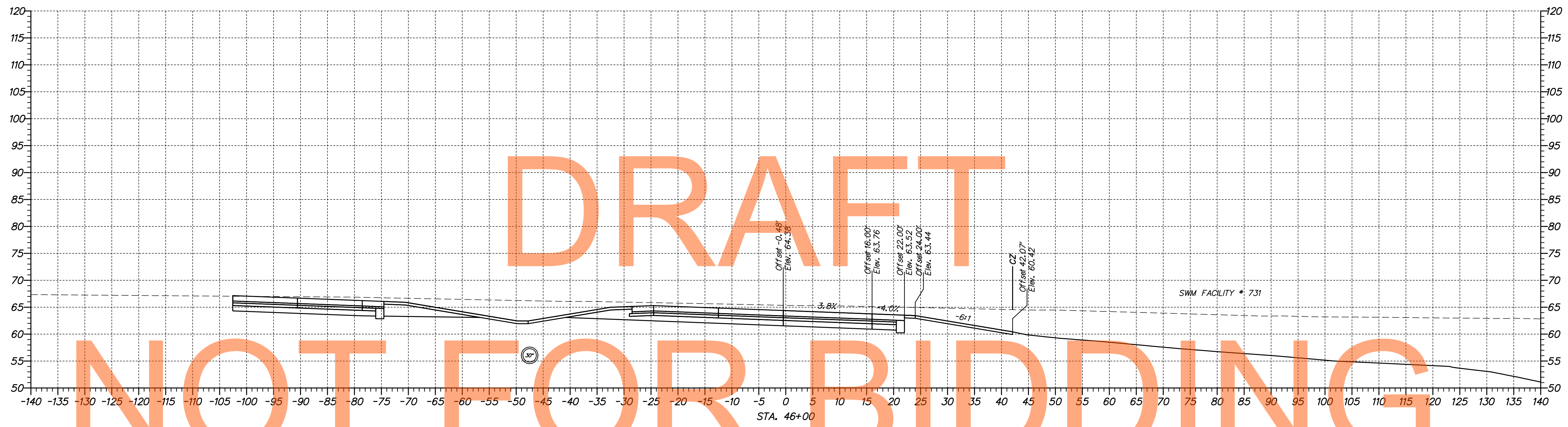

p:\1653-000\con\gract\p\ceadd\US301-IA\_Ramp\_M\_AET\_Sections.dgn  
08/30/2014 10:52:49 AM



ADDENDUMS / REVISIONS	

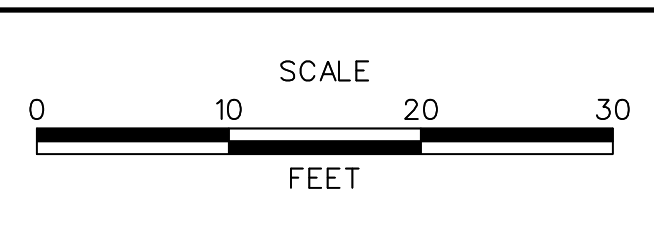

**US 301,  
SR 896 TO SR 1**

CONTRACT T200911308	BRIDGE NO. 
COUNTY NEW CASTLE	DESIGNED BY: MEF CHECKED BY: TAO

<b>CROSS SECTIONS RAMP M</b>	SHEET NO. 294
	TOTAL SHTS. 337

DRAFT

NOT FOR BIDDING

AUGUST 2015

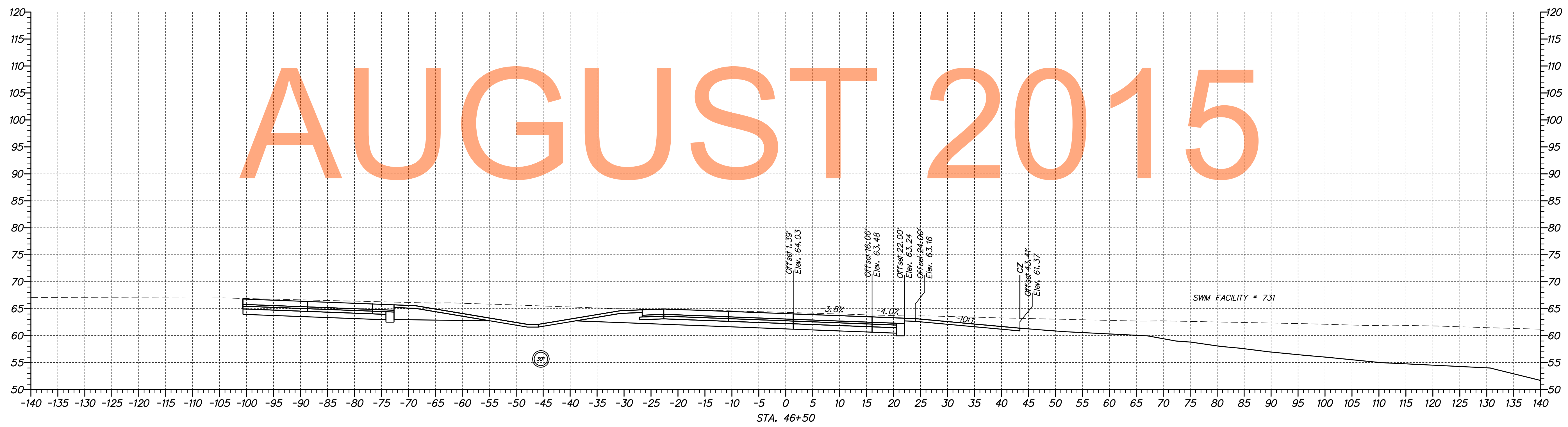
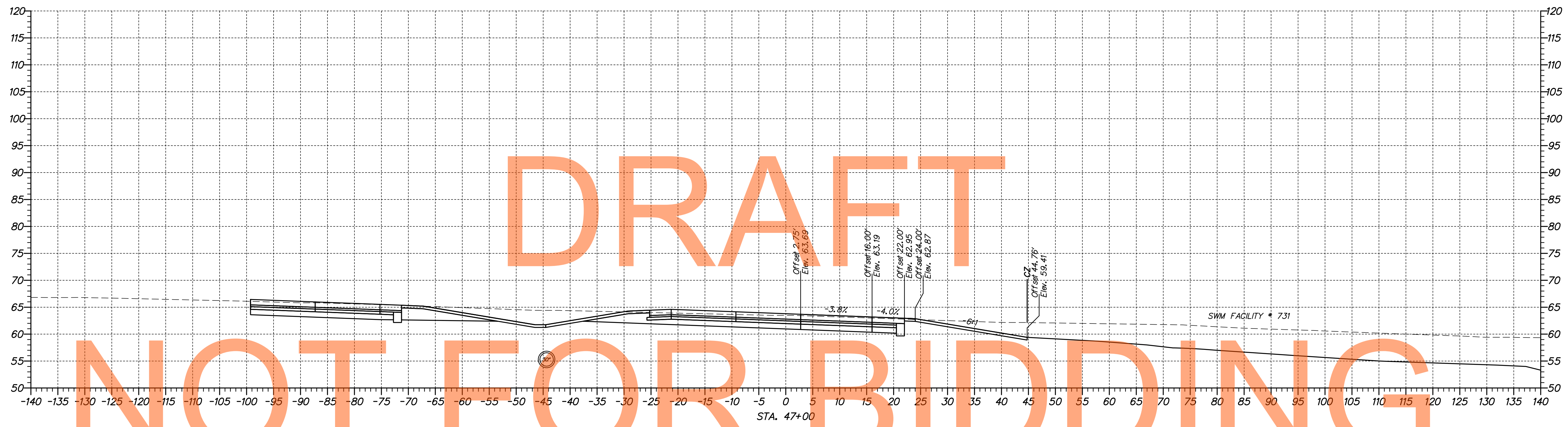

nc:\1653-000\cadd\sect\sect\_1a\_ramp\_m\_aet\_sections.dgn  
07/30/2014 10:25:59 AM



ADDENDUMS / REVISIONS	

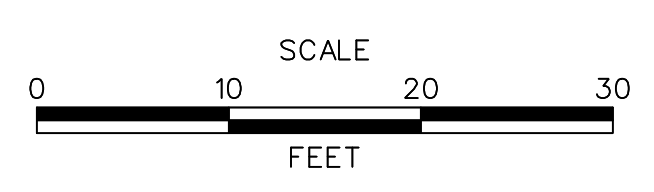

US 301,  
SR 896 TO SR 1

CONTRACT T200911308	BRIDGE NO. 
COUNTY NEW CASTLE	DESIGNED BY: MEF CHECKED BY: TAO

CROSS SECTIONS  
RAMP M

SHEET NO. 295
TOTAL SHTS. 337

DRAFT

NOT FOR BIDDING

AUGUST 2015

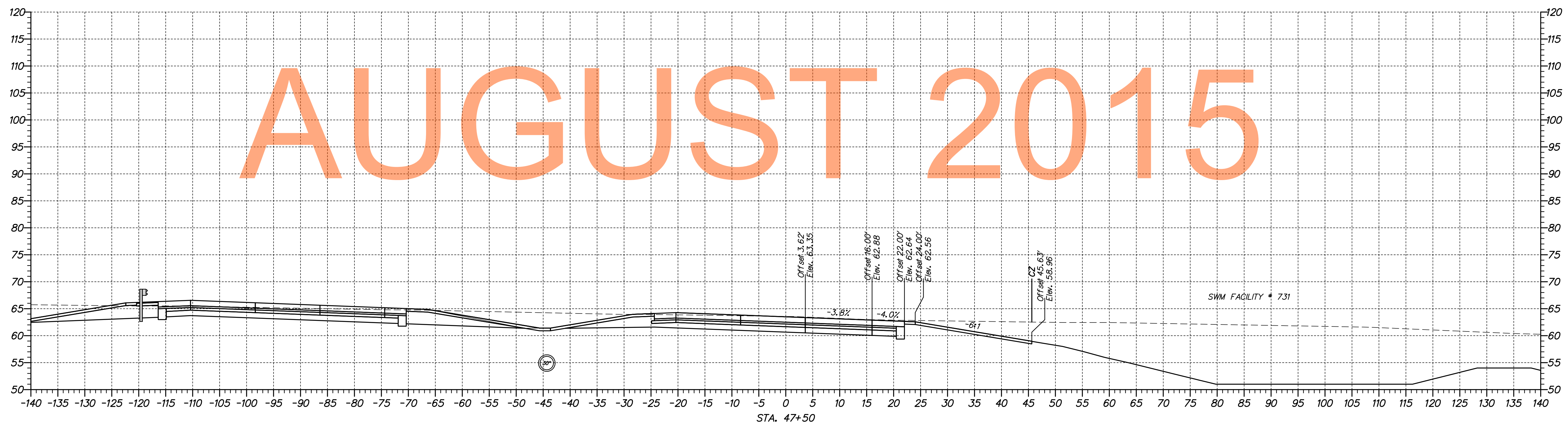
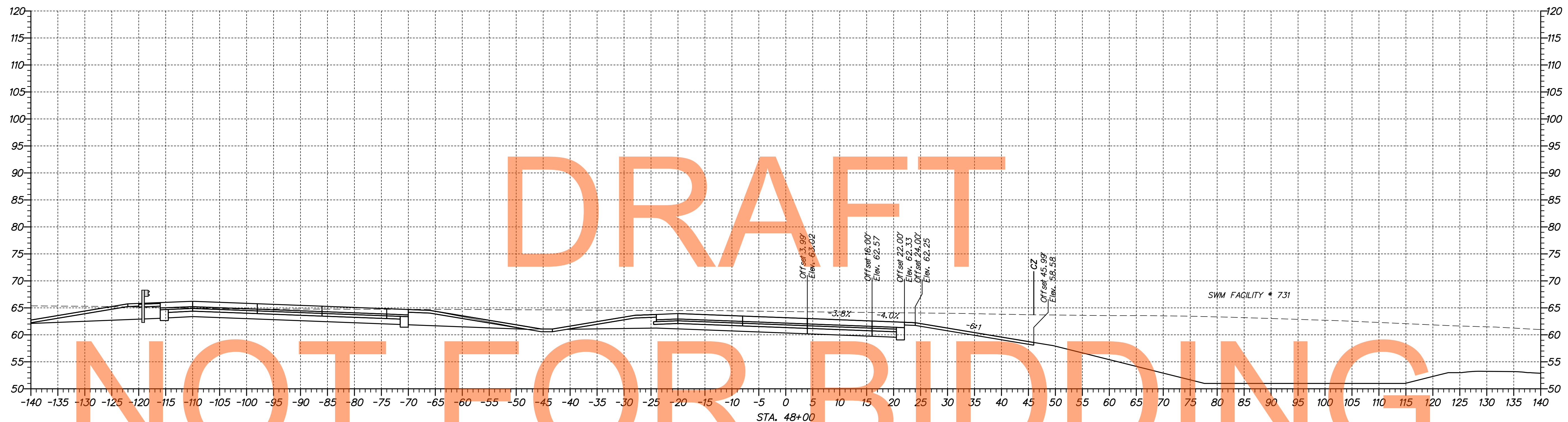

nc:\653-000\contract\1a\cadd\US301\_1A\_Ramp\_M\_AET\_Sections.dgn 07/30/2014 10:25:51 AM



ADDENDUMS / REVISIONS	

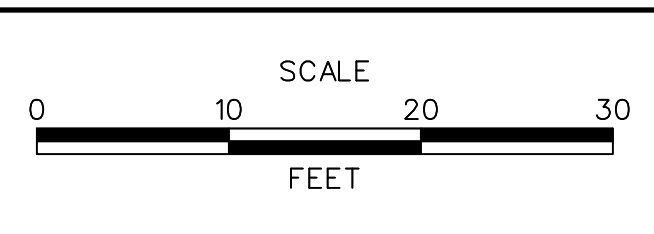

US 301, SR 896 TO SR 1

CONTRACT T200911308	BRIDGE NO.
COUNTY NEW CASTLE	DESIGNED BY: MEF
	CHECKED BY: TAO

CROSS SECTIONS RAMP M

SHEET NO. 296
TOTAL SHTS. 337

# DRAFT

# NOT FOR BIDDING

# AUGUST 2015

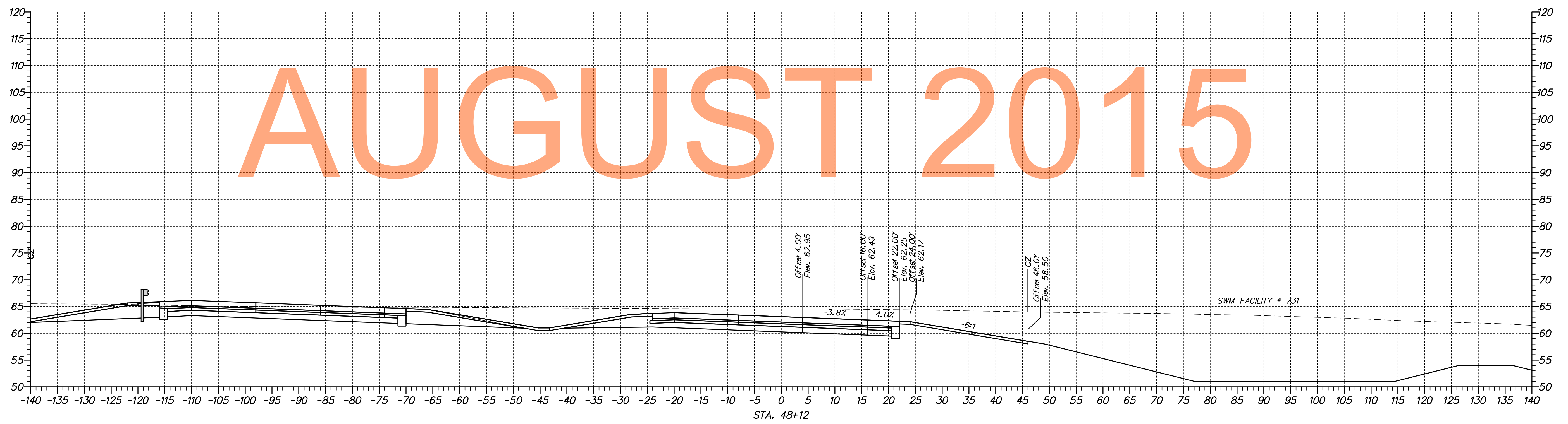

p:\1653-000\con\grc\1a\cadd\US301-1A-Ramp-M-AET-Sections.dgn  
 10/30/2014 10:23:53 AM

**DELAWARE**  
**DEPARTMENT OF TRANSPORTATION**

ADDENDUMS / REVISIONS	

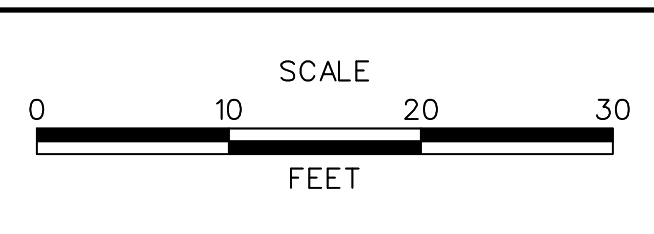

**US 301,**  
**SR 896 TO SR 1**

CONTRACT	BRIDGE NO.
T200911308	
COUNTY	DESIGNED BY: MEF
NEW CASTLE	CHECKED BY: TAO

<b>CROSS SECTIONS</b> <b>RAMP M</b>	SHEET NO.
	297
	TOTAL SHTS.
	337

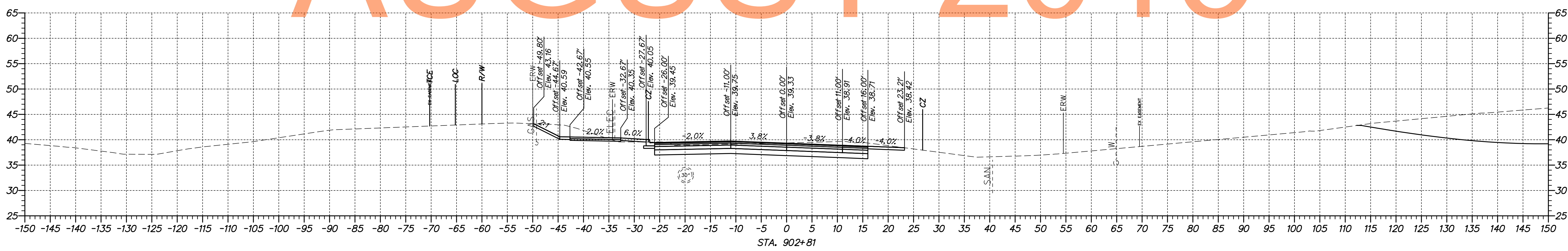
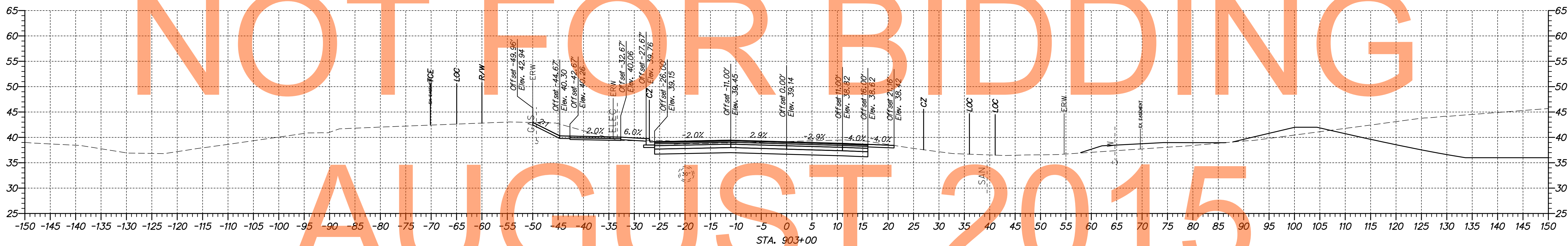
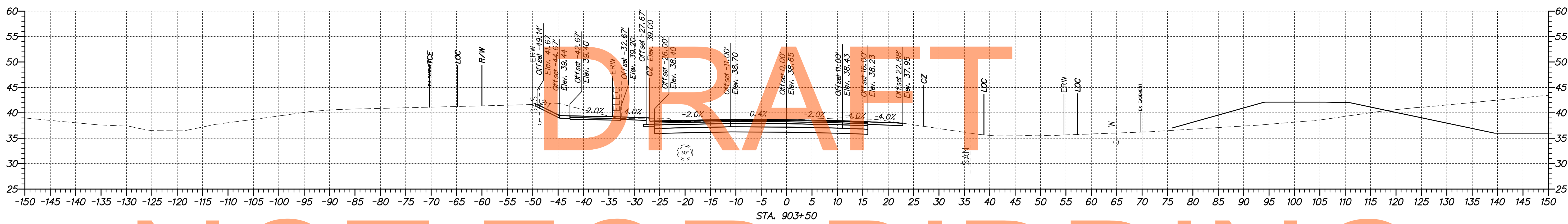
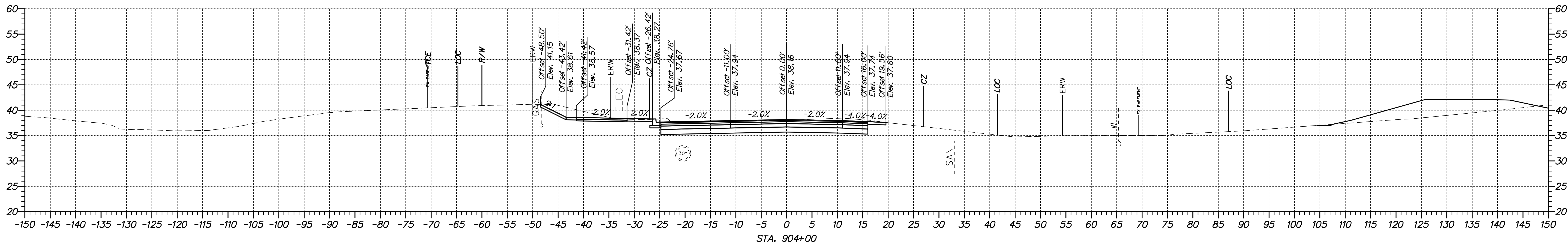

DRAFT

NOT FOR BIDDING

AUGUST 2015

M:\1653-000\CONTRACT 1A\CADD\X500U301\_Hyetta\_1A.dgn  
 2/19/2014 7:18:22 AM

ADDENDUMS / REVISIONS	

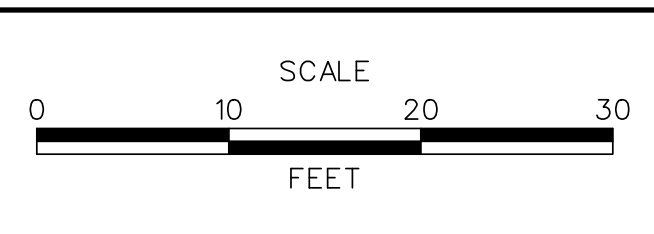

**US 301,**  
**SR 896 TO SR 1**

CONTRACT T200911308	BRIDGE NO.
COUNTY NEW CASTLE	DESIGNED BY: JAD
	CHECKED BY: BRT

<b>CROSS SECTIONS</b>	
<b>HYETTA CORNER ROAD</b>	
SHEET NO. 298	TOTAL SHTS. 337



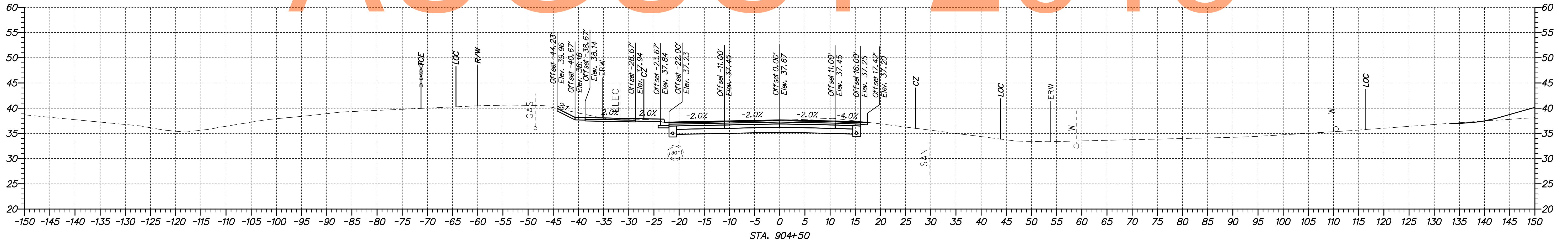
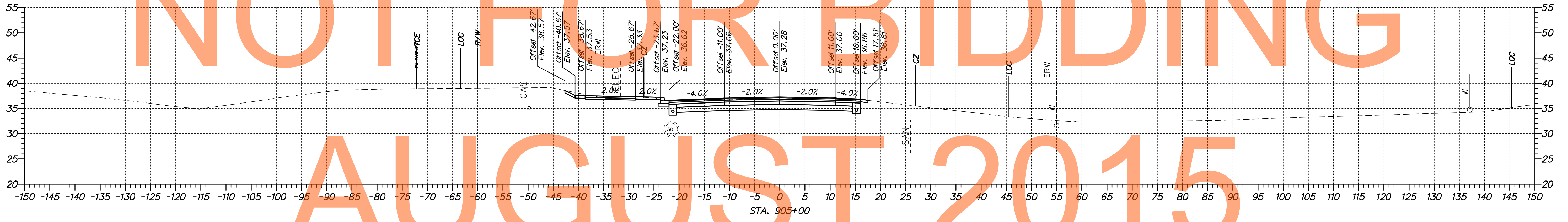
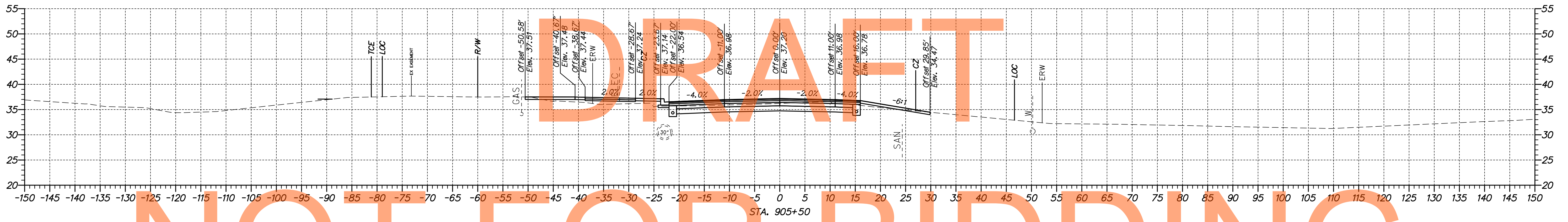
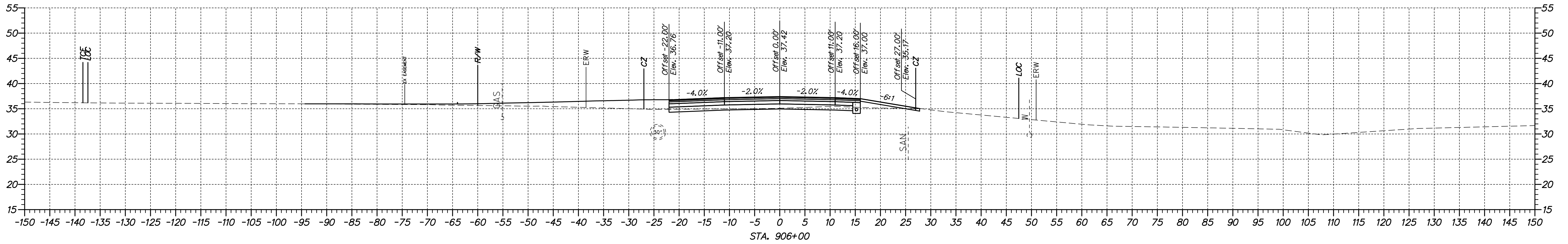

M:\1653-000\CONTRACT 1A\CADD\X500U301\_Hyetta\_1A.dgn  
 12/19/2014 7:48:22 AM

ADDENDUMS / REVISIONS	

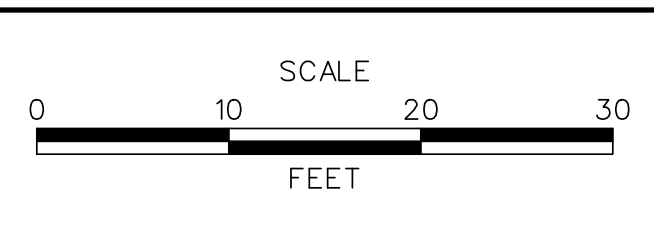

**US 301,**  
**SR 896 TO SR 1**

CONTRACT T200911308	BRIDGE NO.
COUNTY NEW CASTLE	DESIGNED BY: JAD
	CHECKED BY: BRT

**CROSS SECTIONS**  
**HYETTS CORNER ROAD**

SHEET NO. 299
TOTAL SHTS. 337

DRAFT

NOT FOR BIDDING  
AUGUST 2015

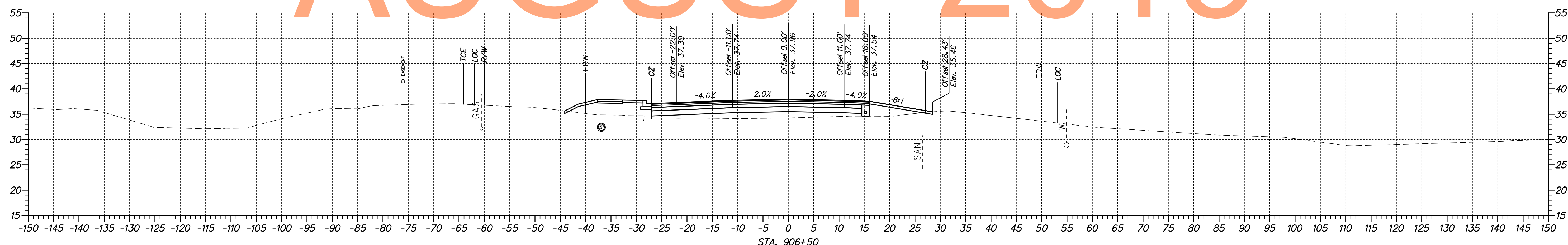
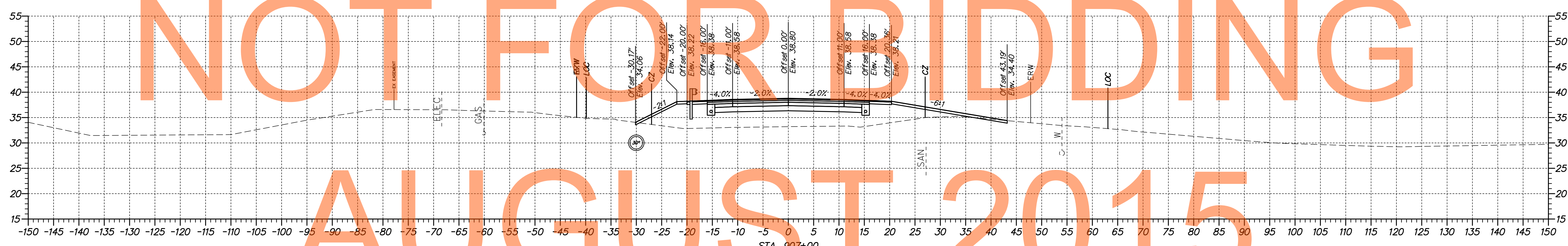
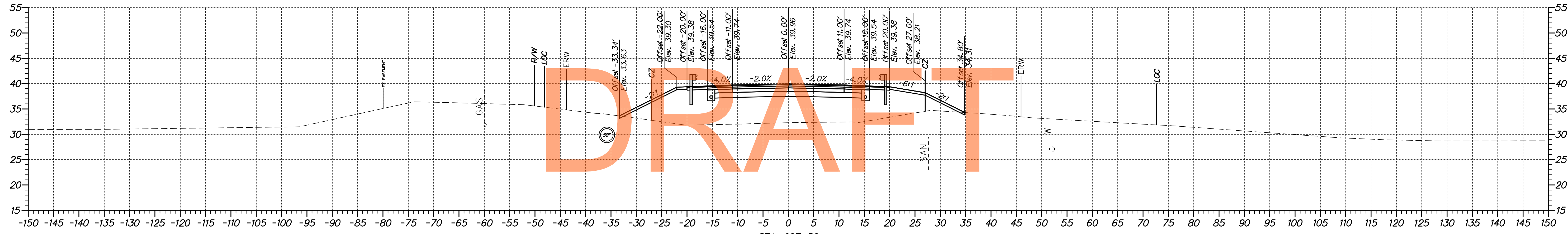

MD:\0653-000\CONTRACT 1A\CADD\X500U301\_Hyetta\_1A.dgn 2/19/2014 7:17:51 AM



ADDENDUMS / REVISIONS	

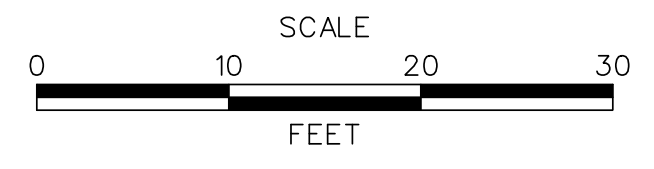

US 301, SR 896 TO SR 1

CONTRACT T200911308	BRIDGE NO.
COUNTY NEW CASTLE	DESIGNED BY: JAD
	CHECKED BY: BRT

CROSS SECTIONS  
HYETTS CORNER ROAD

SHEET NO. 300
TOTAL SHTS. 337