

NOT FOR BIDDING

AUGUST 2015

G:\60049040 US301\CIVIL\PLANS\2A\XSEC\XS234.DGN

DELAWARE DEPARTMENT OF TRANSPORTATION	ADDENDUMS / REVISIONS	SCALE 0 10 20 30 FEET	US 301 LEVELS ROAD TO SUMMIT BRIDGE ROAD	CONTRACT	BRIDGE NO.	CROSS SECTIONS US 301 MAINLINE STA. 443 + 50	SHEET NO.
					T20091303		DESIGNED BY: SS
				COUNTY	CHECKED BY: AM		TOTAL SHTS.
				NEW CASTLE			518

MATCH LINE SEE BELOW LEFT

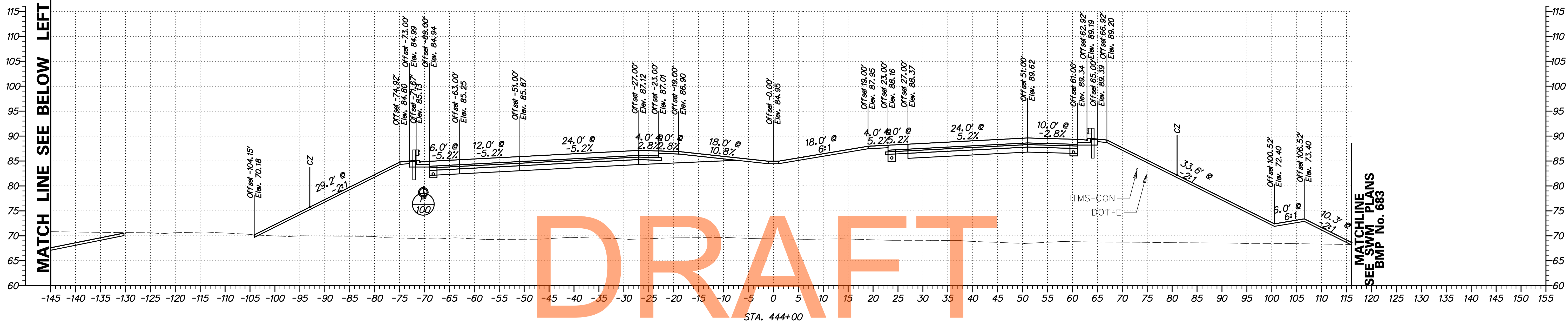

MATCHLINE SEE SWM PLANS BMP No. 683

NOT FOR BIDDING

AUGUST 2015

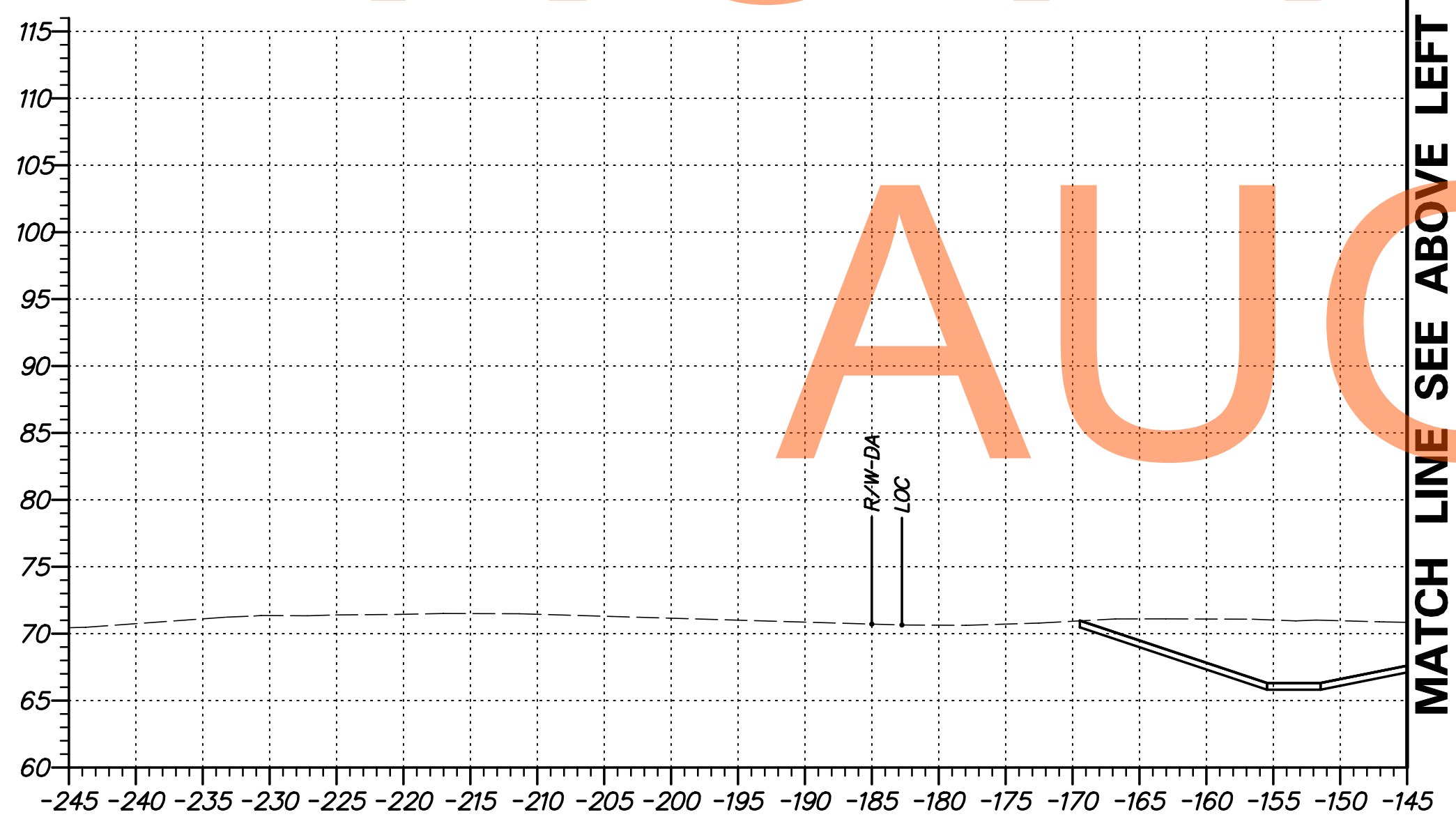

MATCH LINE SEE ABOVE LEFT

G:\60049040 US301\CIVIL\PLANS\2A\XSEC\XS235.DGN

	ADDENDUMS / REVISIONS		SCALE 0 10 20 30 FEET	US 301 LEVELS ROAD TO SUMMIT BRIDGE ROAD	CONTRACT	BRIDGE NO.	CROSS SECTIONS US 301 MAINLINE STA. 444 + 00	SHEET NO.
					T20091303	DESIGNED BY: SS		252
					COUNTY	CHECKED BY: AM	TOTAL SHTS.	
					NEW CASTLE		518	

MATCH LINE SEE BELOW LEFT

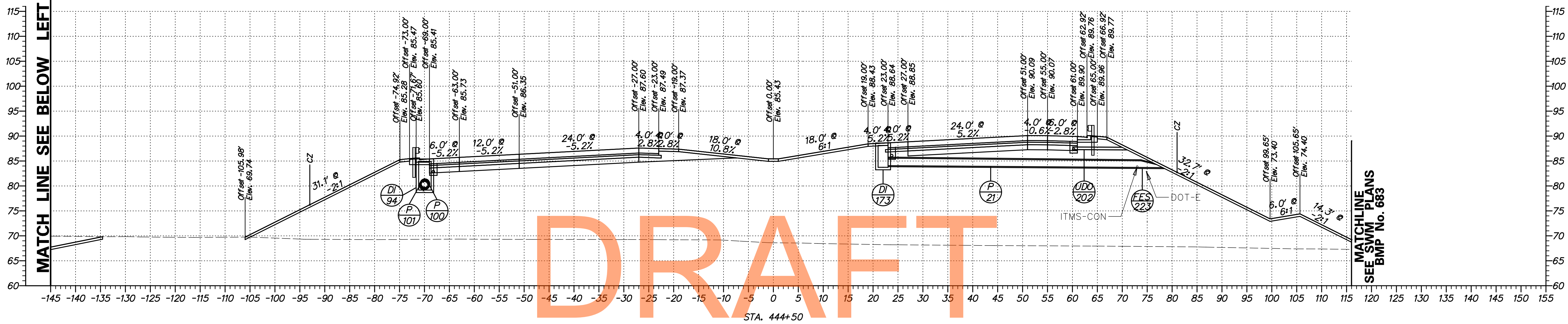

MATCHLINE SEE SWM PLANS BMP No. 683

NOT FOR BIDDING

AUGUST 2015

MATCH LINE SEE ABOVE LEFT

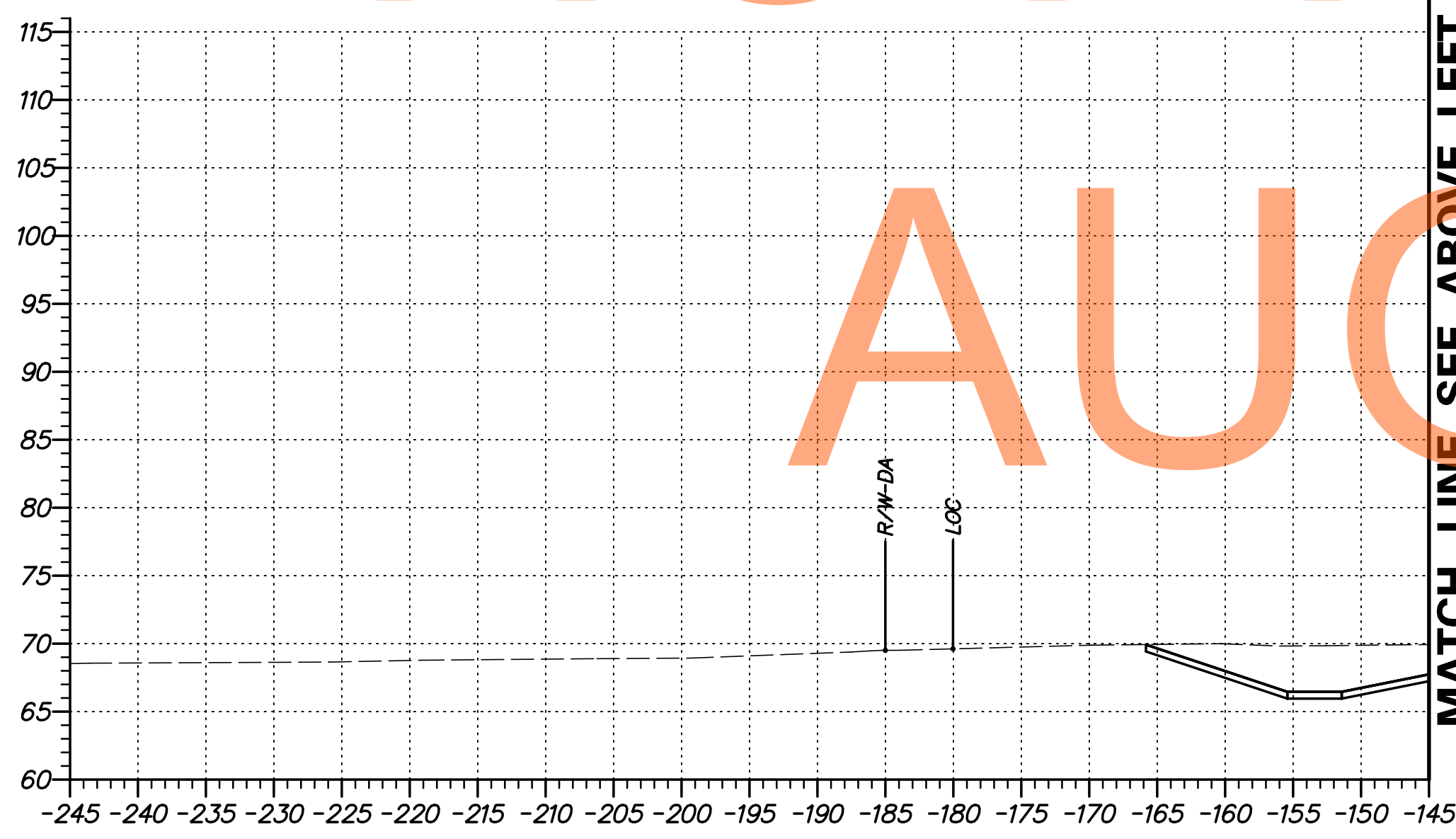

G:\60049040 US301\CIVIL\PLANS\2A\XSEC\XS236.DGN

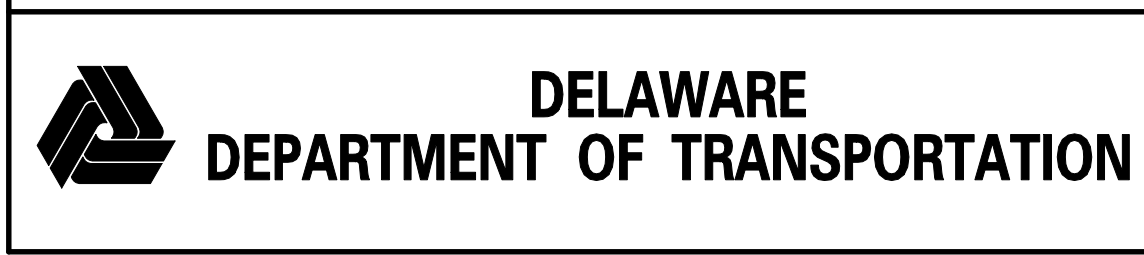

ADDENDUMS / REVISIONS

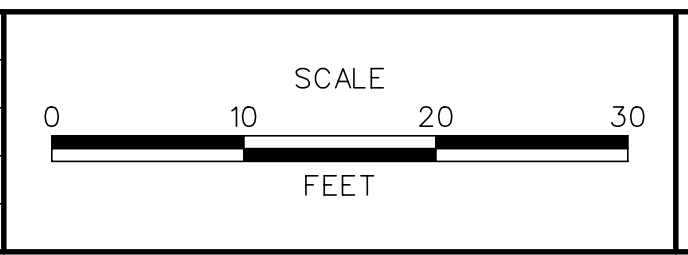

**US 301
LEVELS ROAD
TO SUMMIT BRIDGE ROAD**

CONTRACT T20091303	BRIDGE NO.
COUNTY NEW CASTLE	DESIGNED BY: SS
	CHECKED BY: AM

**CROSS SECTIONS
US 301 MAINLINE
STA. 444 + 50**

SHEET NO. 253
TOTAL SHTS. 518

MATCH LINE SEE BELOW LEFT

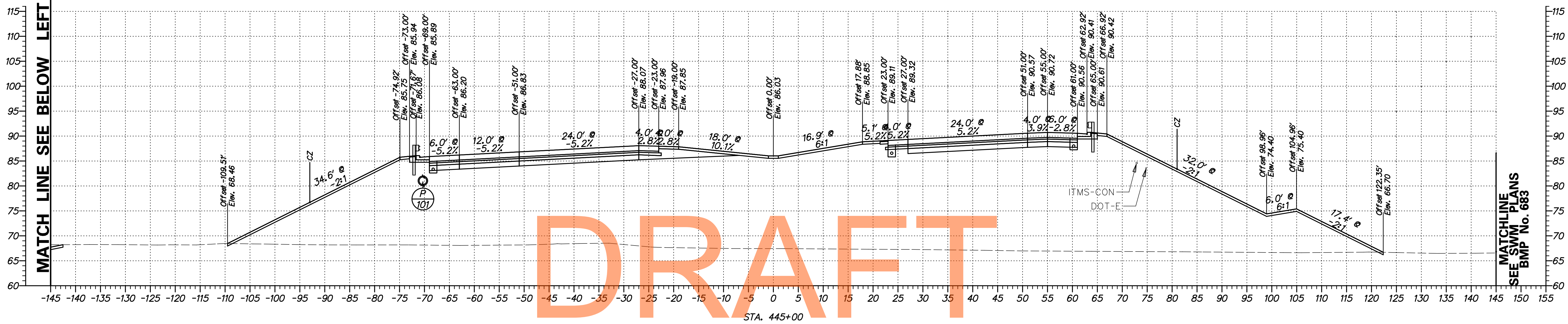

MATCHLINE SEE SWM PLANS BMP No. 683

DRAFT

NOT FOR BIDDING

AUGUST 2015

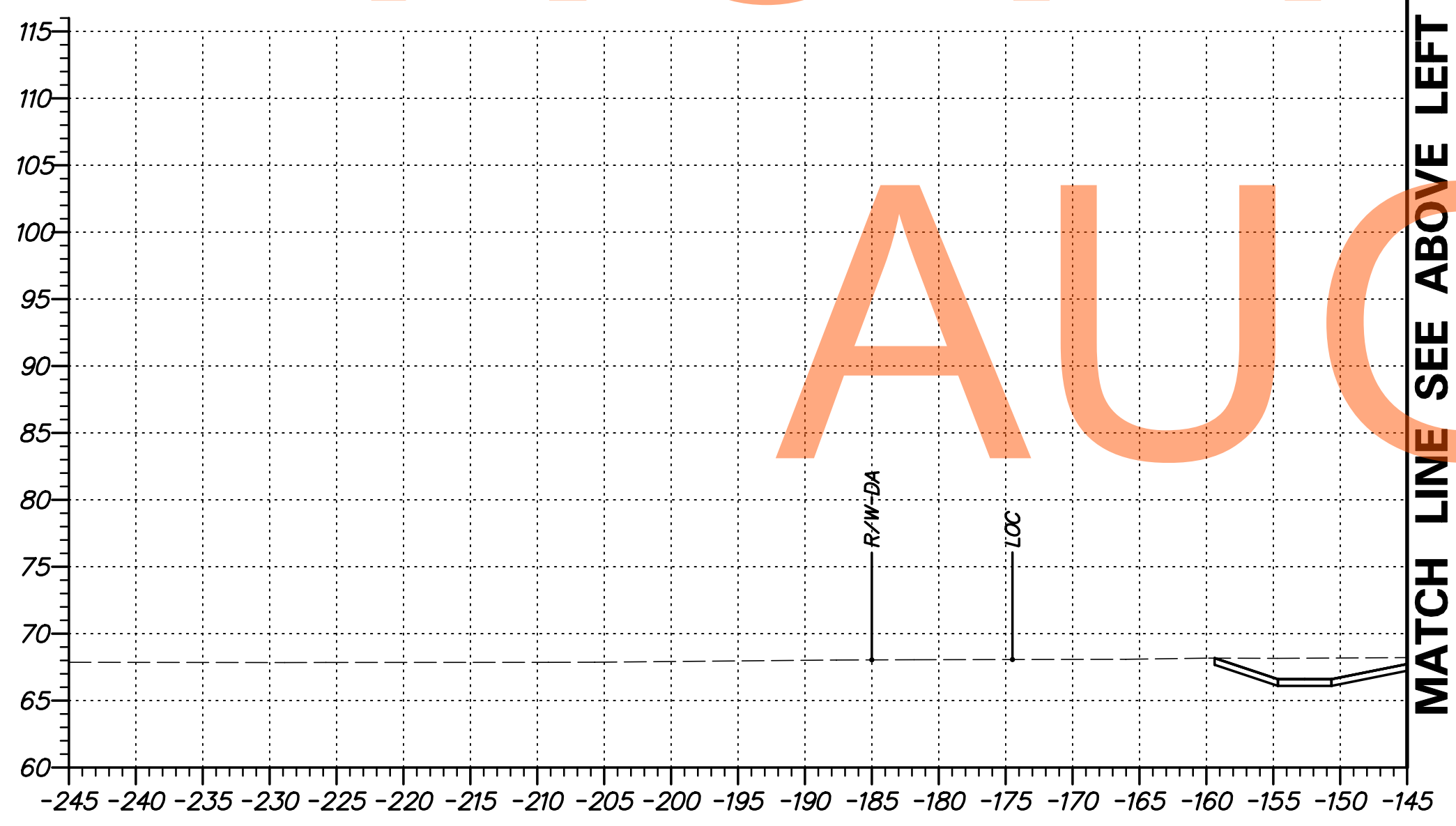

G:\60049040 US30\CIVIL\PLANS\2A\XSEC\XS237.DGN

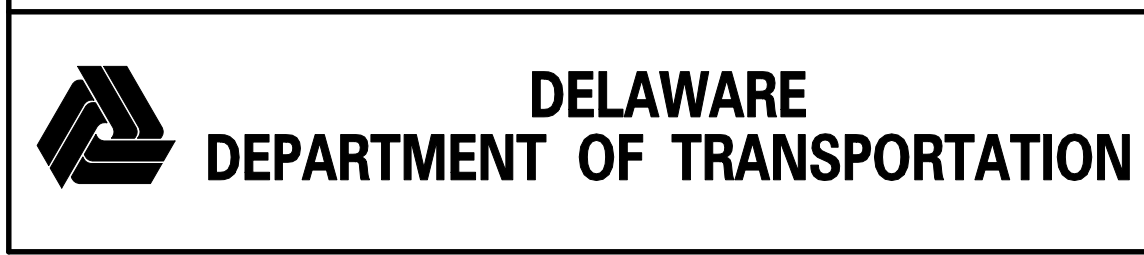

ADDENDUMS / REVISIONS	

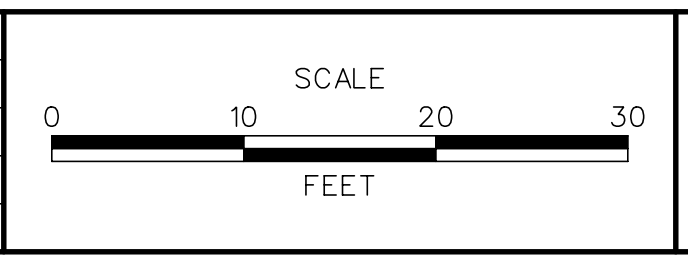

**US 301
LEVELS ROAD
TO SUMMIT BRIDGE ROAD**

CONTRACT	BRIDGE NO.
T20091303	
COUNTY	DESIGNED BY: SS
NEW CASTLE	CHECKED BY: AM

**CROSS SECTIONS
US 301 MAINLINE
STA. 445 + 00**

SHEET NO.
254
TOTAL SHTS.
518

MATCH LINE SEE BELOW LEFT

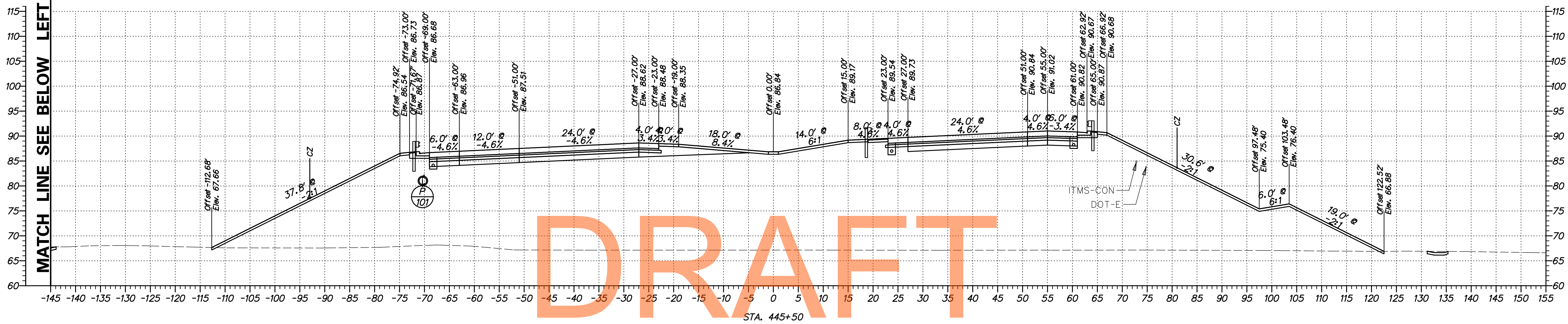

DRAFT

NOT FOR BIDDING

AUGUST 2015

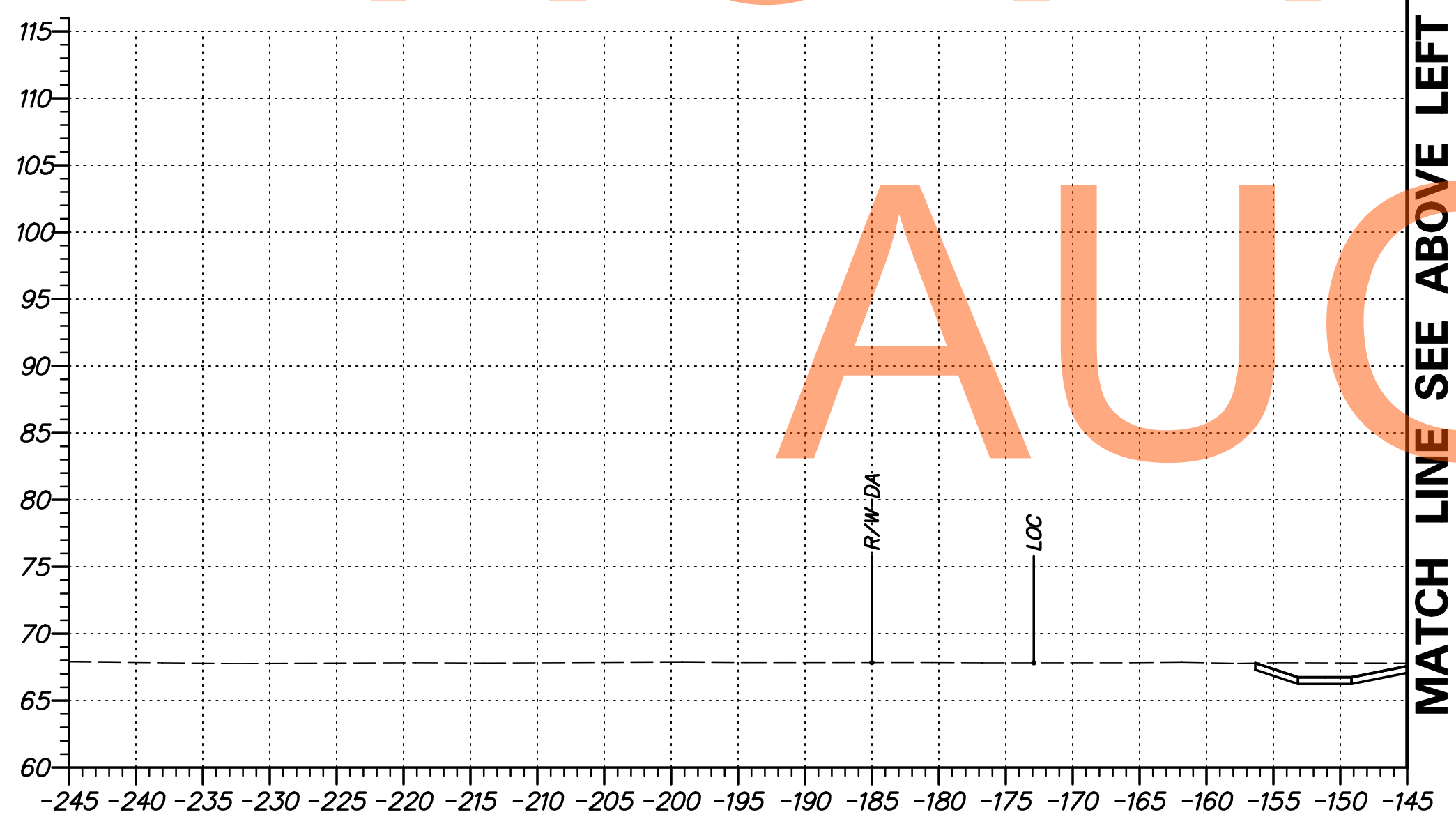

G:\60049040 US301\CIVIL\PLANS\2A\XSEC\XS238.DGN

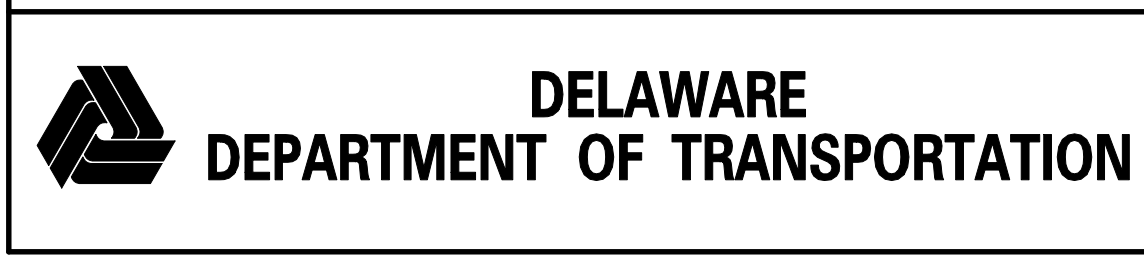

ADDENDUMS / REVISIONS	

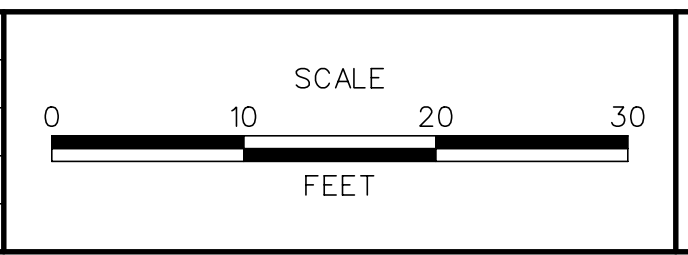

US 301
LEVELS ROAD
TO SUMMIT BRIDGE ROAD

CONTRACT	BRIDGE NO.
T20091303	
COUNTY	DESIGNED BY: SS
NEW CASTLE	CHECKED BY: AM

CROSS SECTIONS
US 301 MAINLINE
STA. 445 + 50

SHEET NO.
255
TOTAL SHTS.
518

MATCH LINE SEE BELOW LEFT

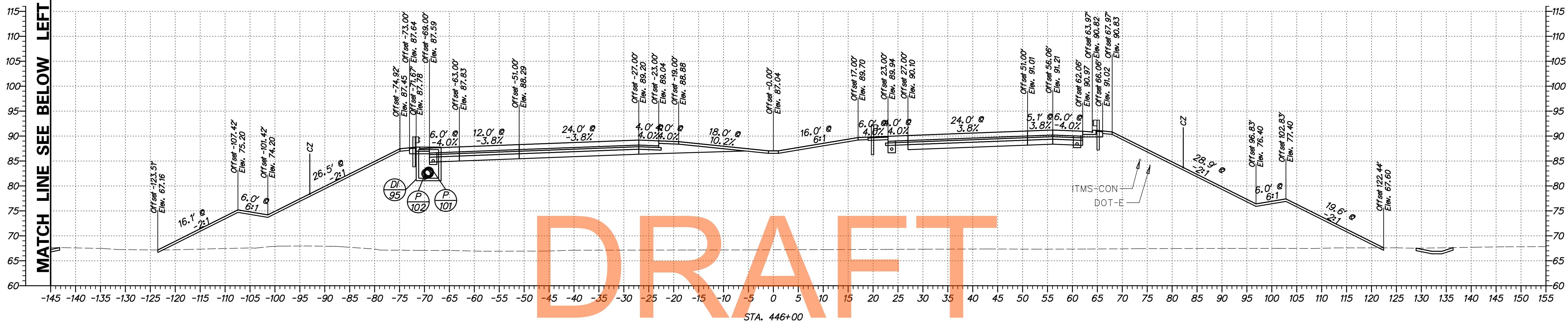

DRAFT

NOT FOR BIDDING

AUGUST 2015

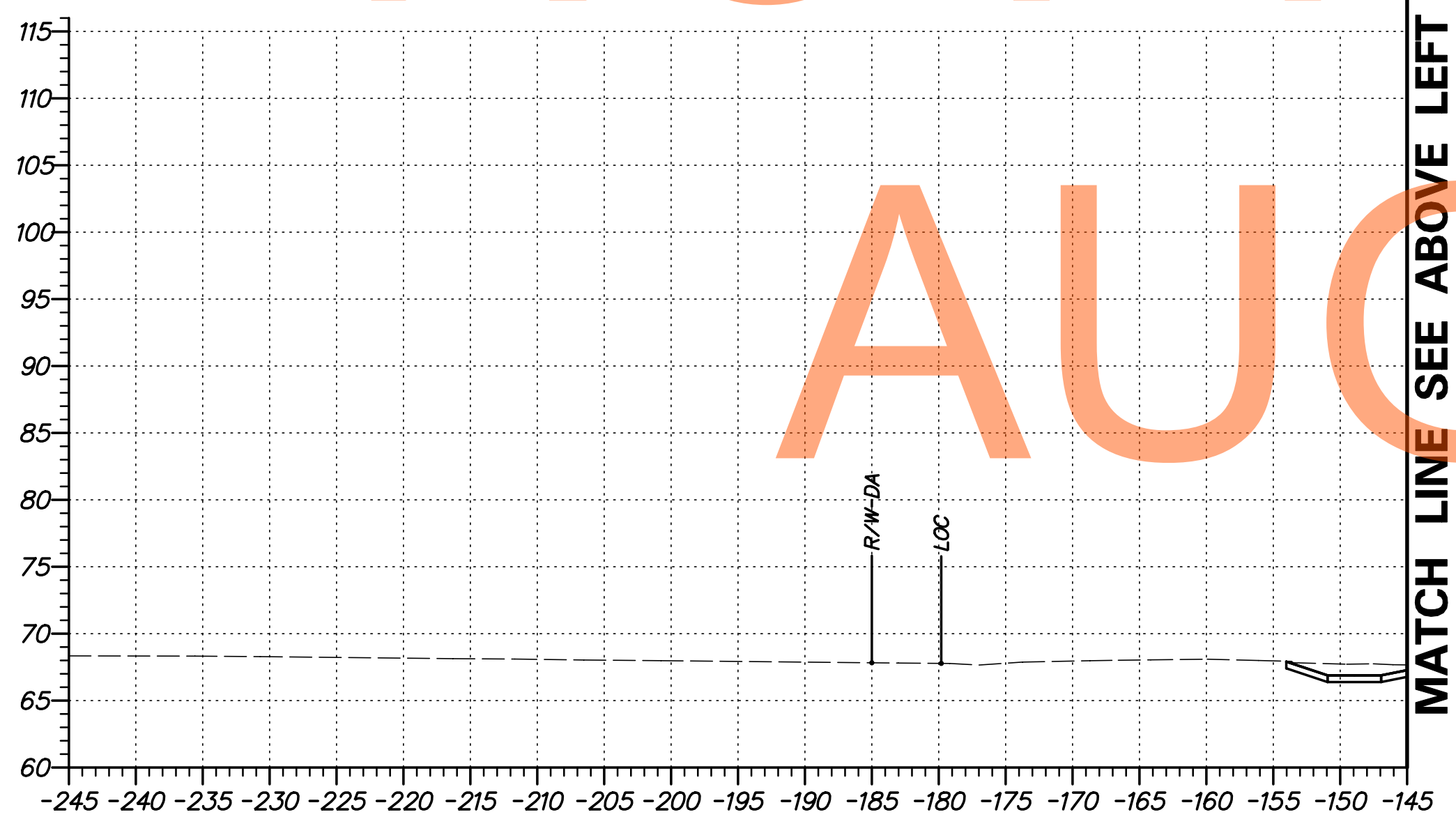

MATCH LINE SEE ABOVE LEFT

G:\60049040 US301\CIVIL\PLANS\2A\XSEC\XS239.DGN

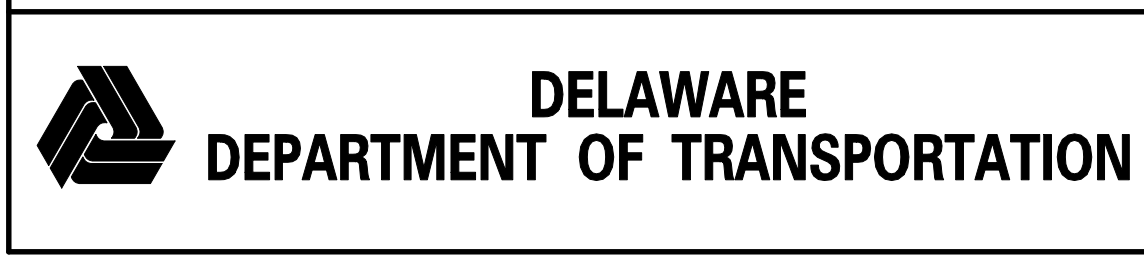

ADDENDUMS / REVISIONS	

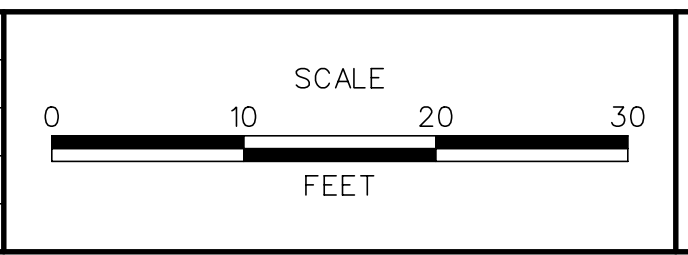

**US 301
LEVELS ROAD
TO SUMMIT BRIDGE ROAD**

CONTRACT	BRIDGE NO.
T20091303	
COUNTY	DESIGNED BY: SS
NEW CASTLE	CHECKED BY: AM

**CROSS SECTIONS
US 301 MAINLINE
STA. 446 + 00**

SHEET NO.
256
TOTAL SHTS.
518

MATCH LINE SEE BELOW LEFT

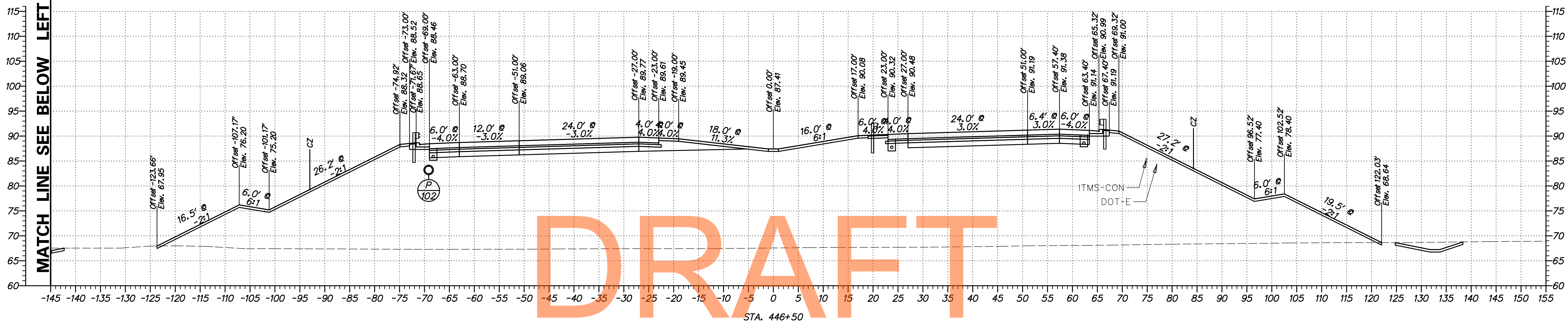

DRAFT

NOT FOR BIDDING

AUGUST 2015

MATCH LINE SEE ABOVE LEFT

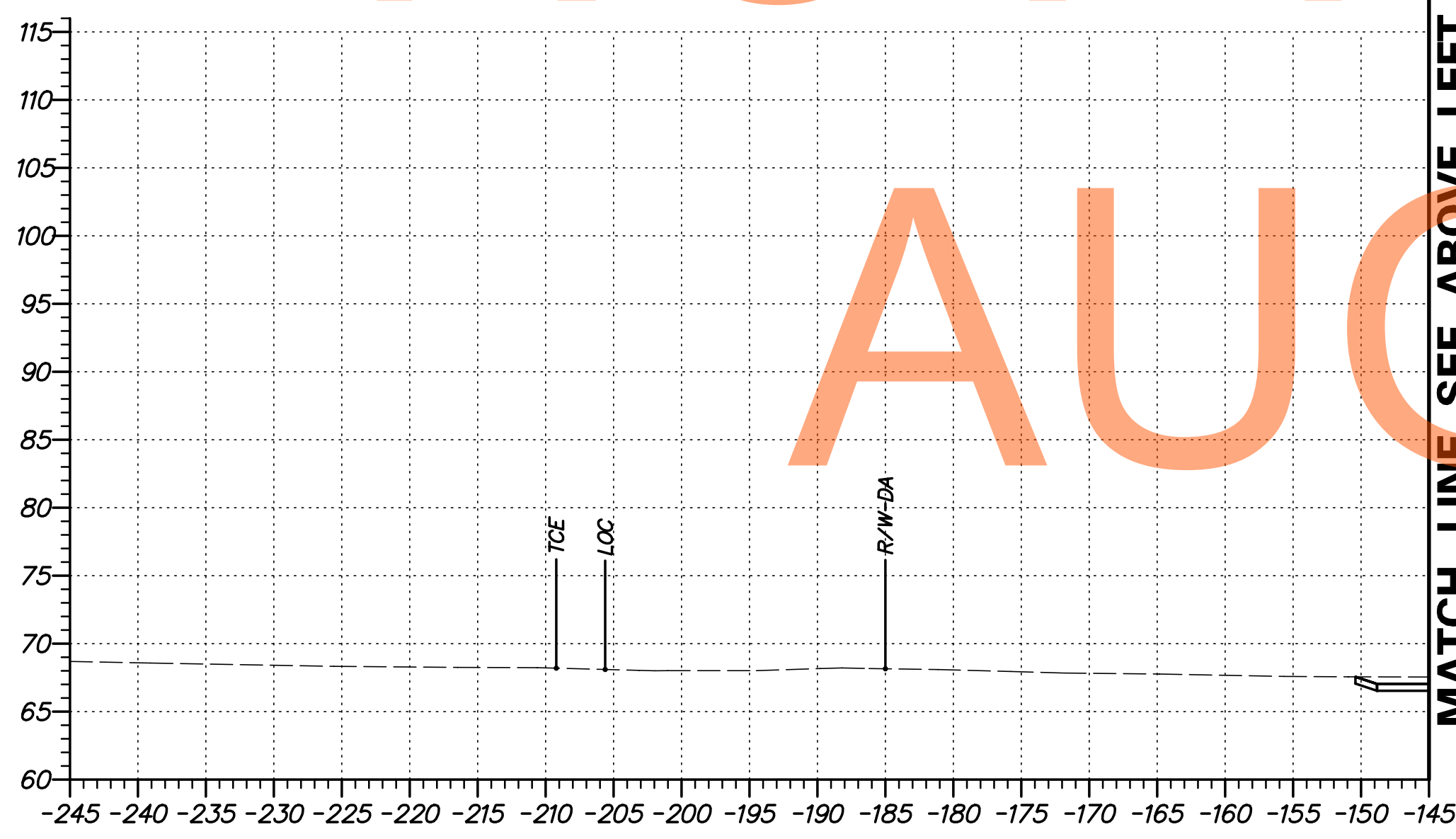

G:\60049040 US301\CIVIL\PLANS\2A\XSEC\XS240.DGN

DELAWARE DEPARTMENT OF TRANSPORTATION

ADDENDUMS / REVISIONS	

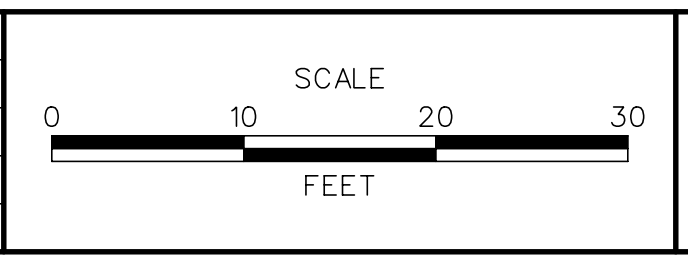

US 301 LEVELS ROAD TO SUMMIT BRIDGE ROAD

CONTRACT T20091303	BRIDGE NO.
COUNTY NEW CASTLE	DESIGNED BY: SS
	CHECKED BY: AM

CROSS SECTIONS US 301 MAINLINE STA. 446 + 50

SHEET NO. 257
TOTAL SHTS. 518

MATCH LINE SEE BELOW LEFT

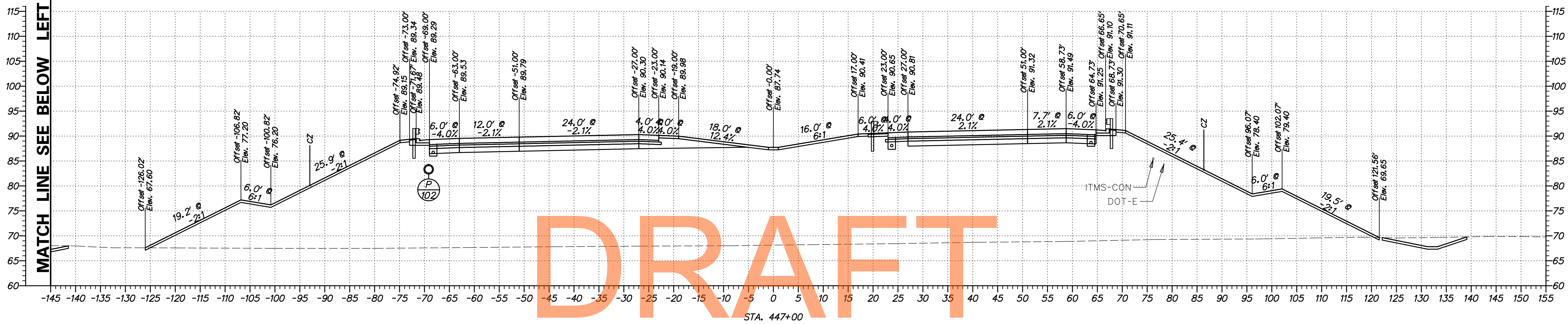

DRAFT

NOT FOR BIDDING

AUGUST 2015

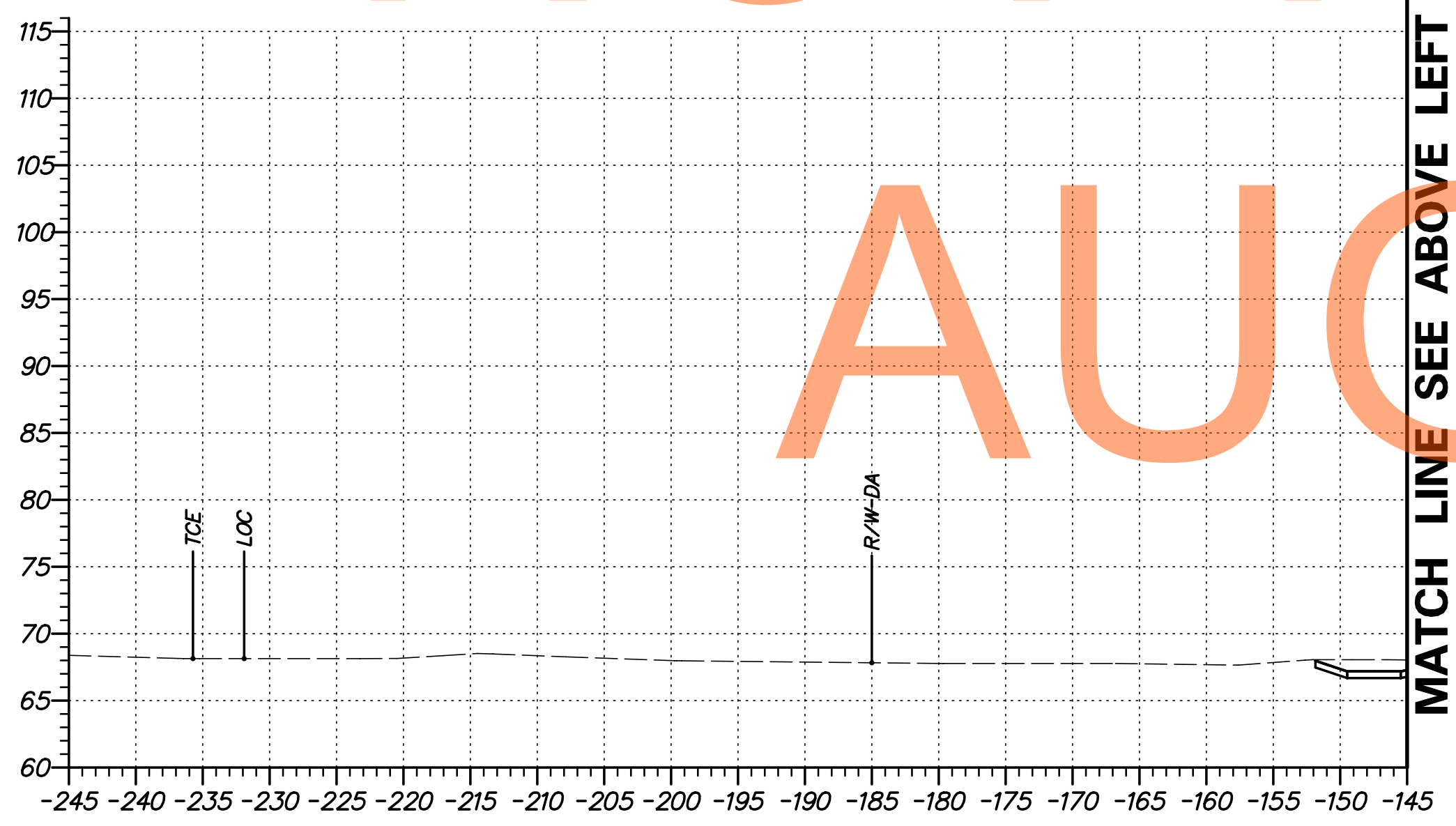

MATCH LINE SEE ABOVE LEFT

G:\60049040 US301\CIVIL\PLANS\2A\XSEC\XS241.DGN



ADDENDUMS / REVISIONS	

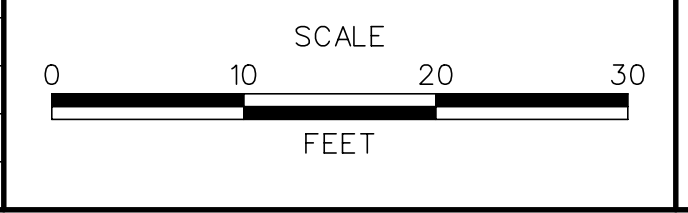

**US 301
LEVELS ROAD
TO SUMMIT BRIDGE ROAD**

CONTRACT T20091303	BRIDGE NO.
COUNTY NEW CASTLE	DESIGNED BY: SS
	CHECKED BY: AM

**CROSS SECTIONS
US 301 MAINLINE
STA. 447 + 00**

SHEET NO. 258
TOTAL SHTS. 518

MATCH LINE SEE BELOW LEFT

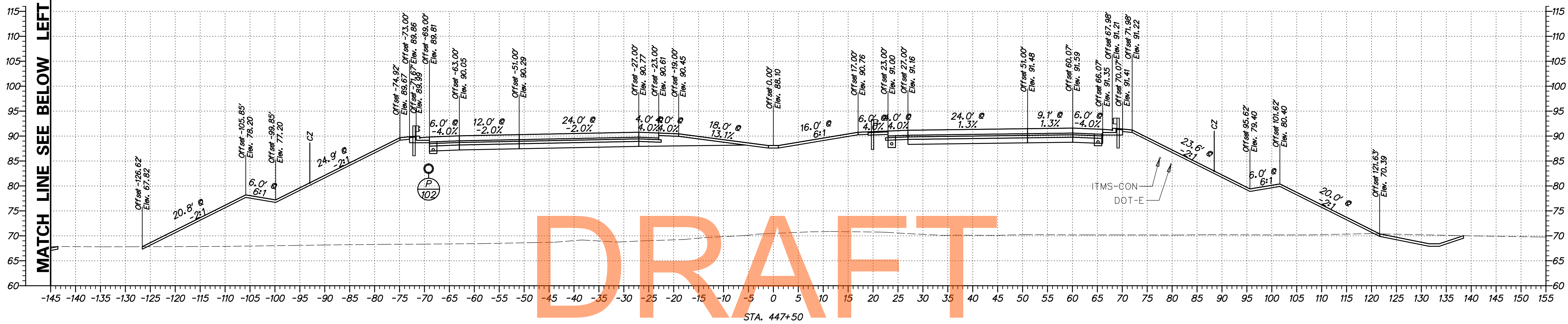

DRAFT

NOT FOR BIDDING

AUGUST 2015

MATCH LINE SEE ABOVE LEFT

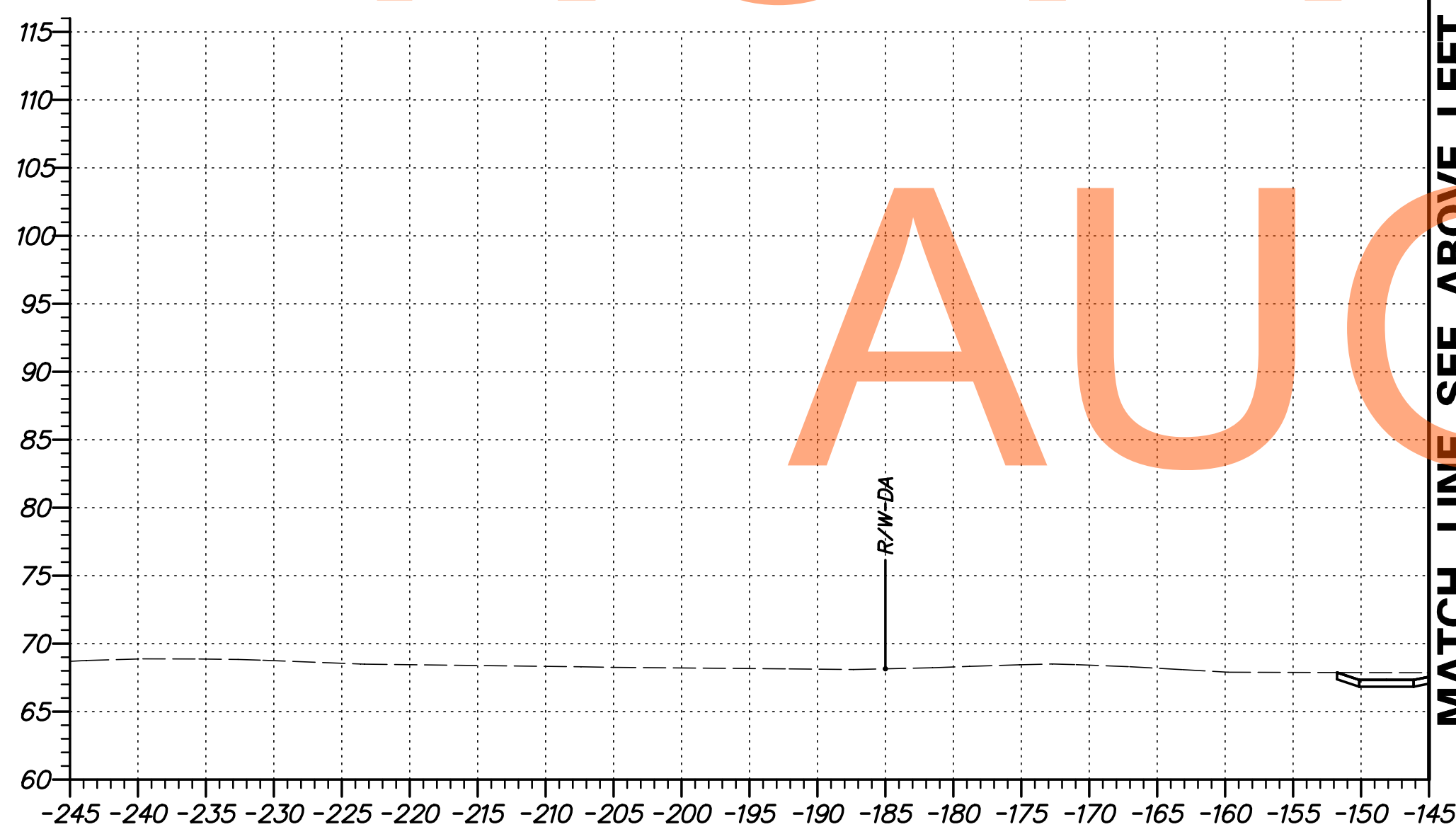

G:\60049040 US301\CIVIL\PLANS\2A\XSEC\XS242.DGN

DELAWARE DEPARTMENT OF TRANSPORTATION

ADDENDUMS / REVISIONS

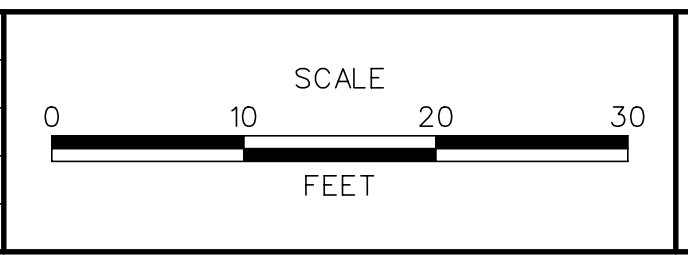

US 301 LEVELS ROAD TO SUMMIT BRIDGE ROAD

CONTRACT	BRIDGE NO.
T20091303	
COUNTY	DESIGNED BY: SS
NEW CASTLE	CHECKED BY: AM

CROSS SECTIONS US 301 MAINLINE STA. 447 + 50

SHEET NO.
259
TOTAL SHTS.
518

MATCH LINE SEE BELOW LEFT

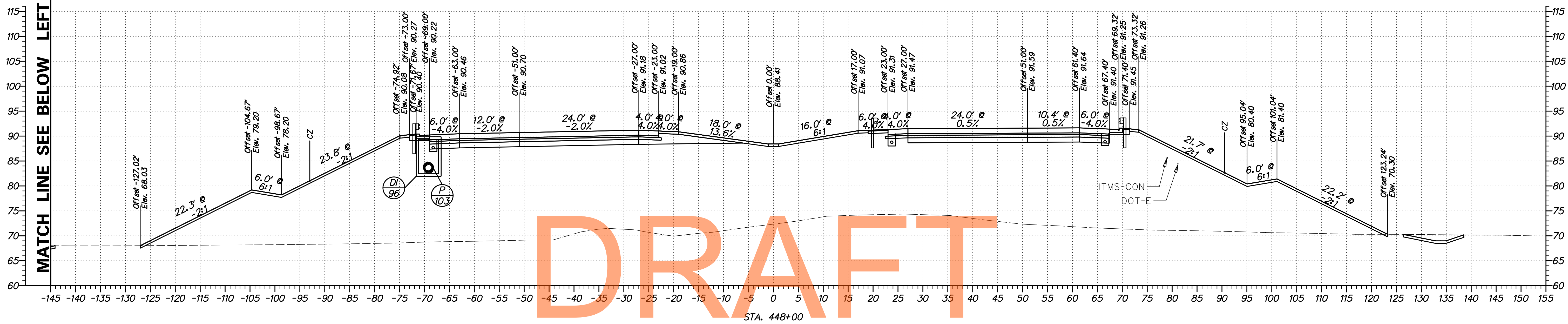

DRAFT

NOT FOR BIDDING

AUGUST 2015

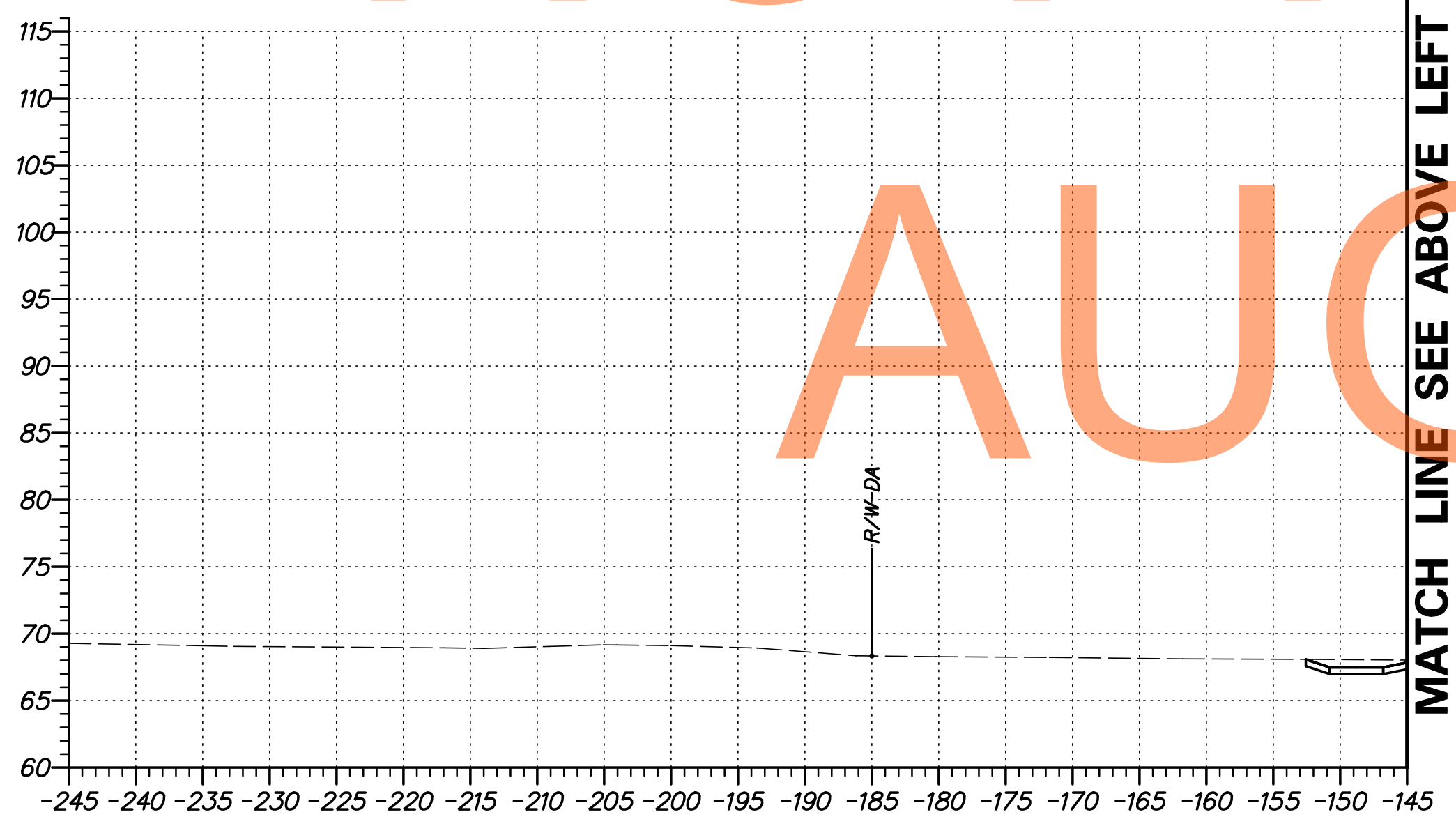

MATCH LINE SEE ABOVE LEFT

G:\60049040 US301\CIVIL\PLANS\2A\XSEC\XS24.3.DGN

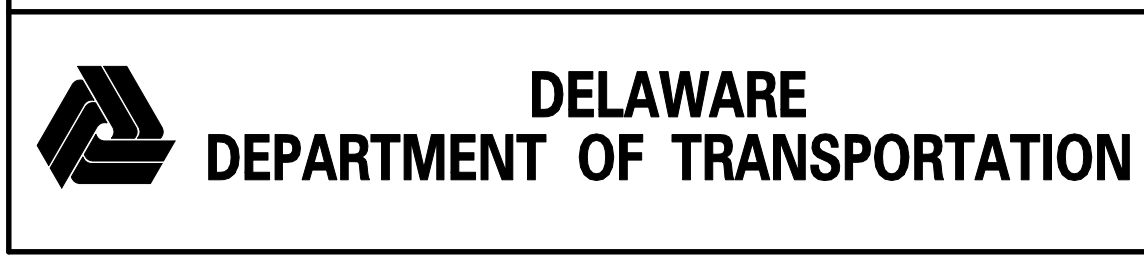

ADDENDUMS / REVISIONS	

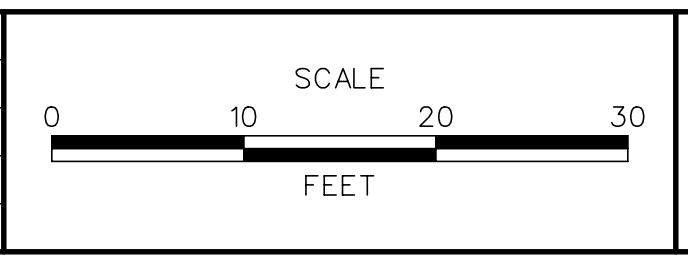

**US 301
LEVELS ROAD
TO SUMMIT BRIDGE ROAD**

CONTRACT T20091303	BRIDGE NO.
COUNTY NEW CASTLE	DESIGNED BY: SS
	CHECKED BY: AM

**CROSS SECTIONS
US 301 MAINLINE
STA. 448 + 00**

SHEET NO. 260
TOTAL SHTS. 518

MATCH LINE SEE BELOW LEFT

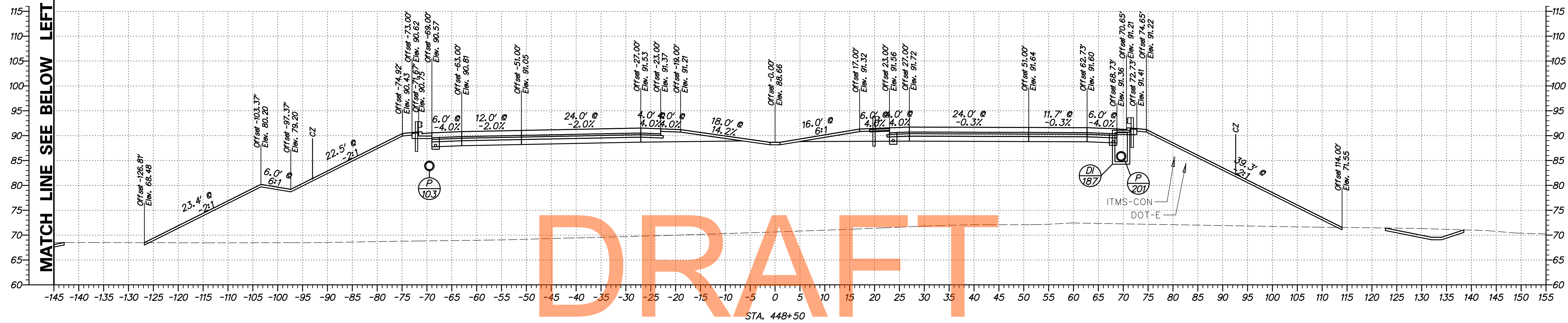

STA. 448+50

DRAFT

NOT FOR BIDDING

AUGUST 2015

MATCH LINE SEE ABOVE LEFT

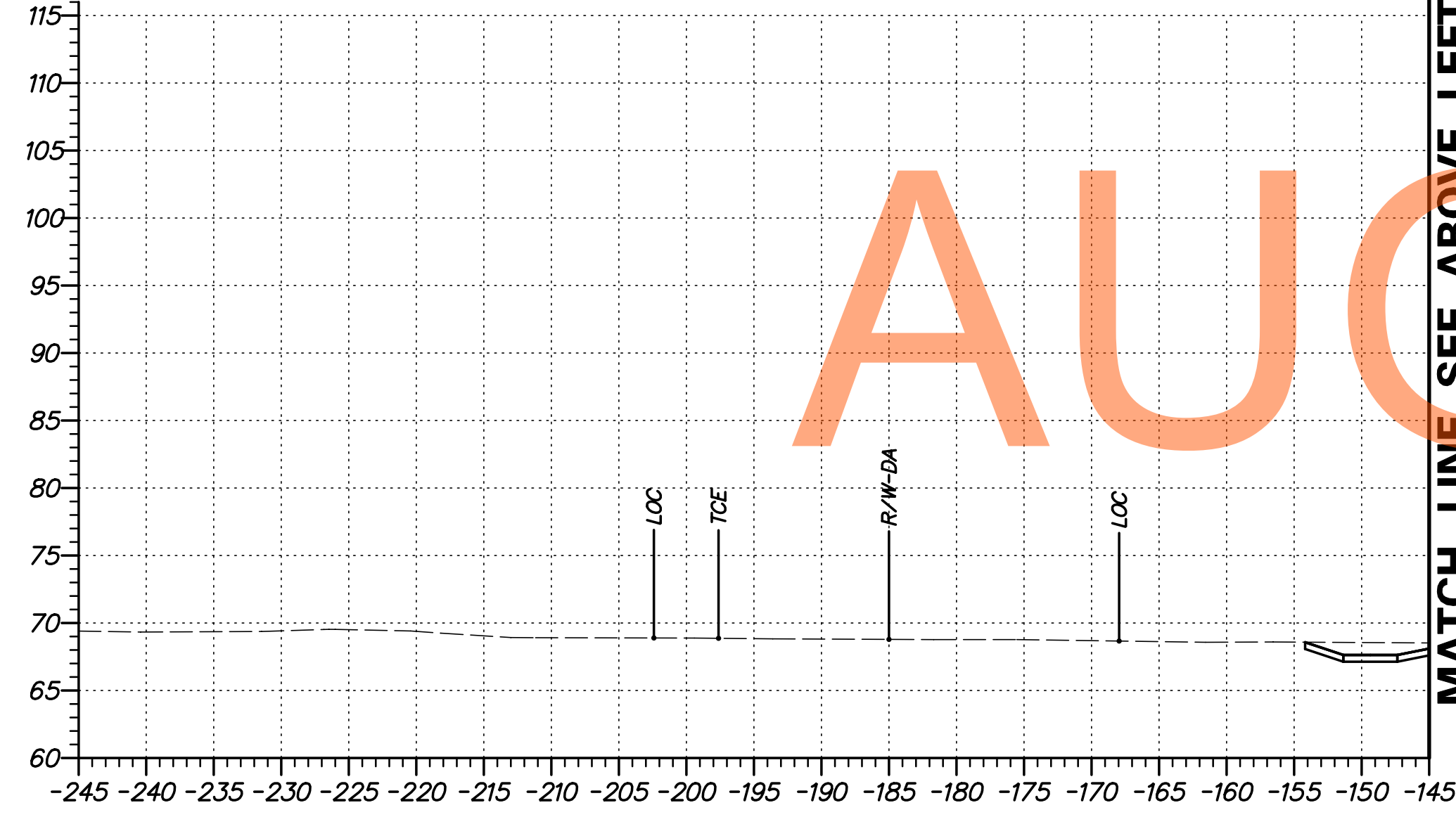

G:\60049040 US30\CIVIL\PLANS\2A\XSEC\XS244.DGN

	ADDENDUMS / REVISIONS		SCALE 0 10 20 30 FEET	US 301 LEVELS ROAD TO SUMMIT BRIDGE ROAD	CONTRACT	BRIDGE NO.	CROSS SECTIONS US 301 MAINLINE STA. 448 + 50	SHEET NO.
					T20091303			DESIGNED BY: SS
					COUNTY	CHECKED BY: AM	TOTAL SHTS.	
					NEW CASTLE		518	

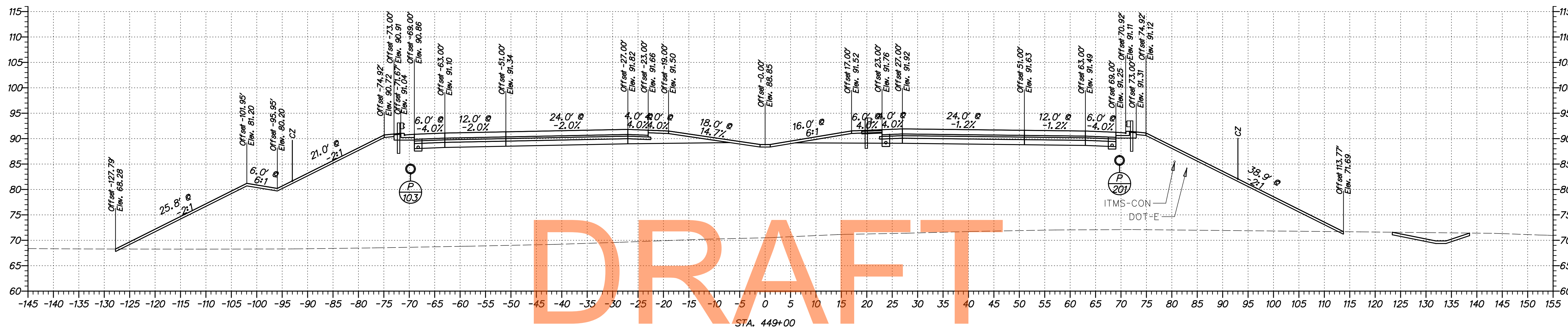

DRAFT

NOT FOR BIDDING
AUGUST 2015

G:\60049040 US301\CIVIL\PLANS\2A\YSEC\XS245.DGN

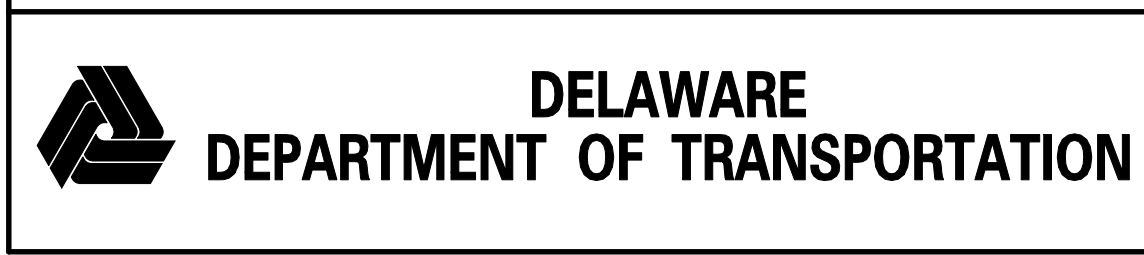

ADDENDUMS / REVISIONS	

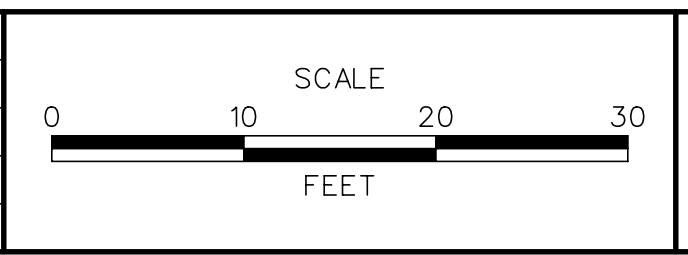

**US 301
LEVELS ROAD
TO SUMMIT BRIDGE ROAD**

CONTRACT T20091303	BRIDGE NO.
COUNTY NEW CASTLE	DESIGNED BY: SS
	CHECKED BY: AM

**CROSS SECTIONS
US 301 MAINLINE
STA. 449 + 00**

SHEET NO. 262
TOTAL SHTS. 518

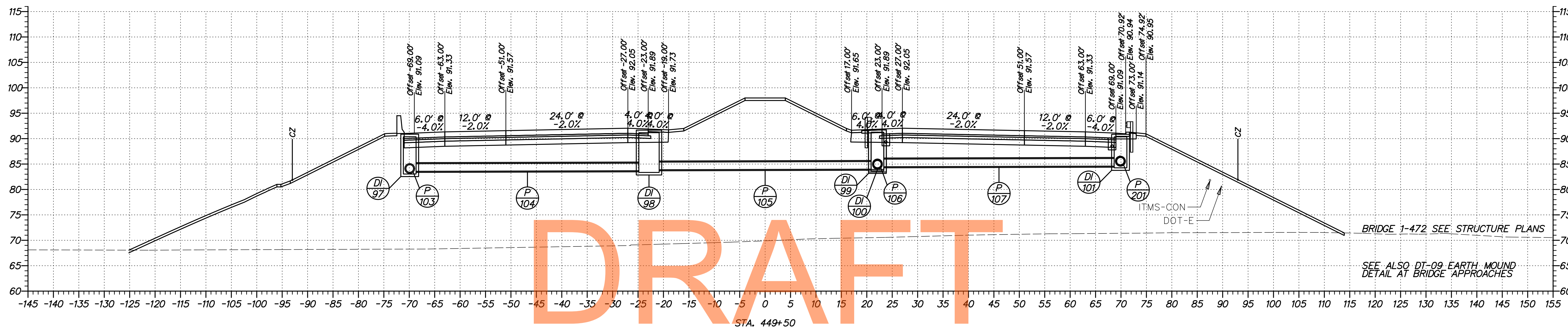

DRAFT

NOT FOR BIDDING

AUGUST 2015

G:\60049040 US301\CIVIL\PLANS\2A\XSEC\XS246.DGN

DELAWARE DEPARTMENT OF TRANSPORTATION	ADDENDUMS / REVISIONS	SCALE 0 10 20 30 FEET	US 301 LEVELS ROAD TO SUMMIT BRIDGE ROAD	CONTRACT	BRIDGE NO.	CROSS SECTIONS US 301 MAINLINE STA. 449 + 50	SHEET NO.
					T20091303		DESIGNED BY: SS
				COUNTY	CHECKED BY: AM		TOTAL SHTS.
				NEW CASTLE			518

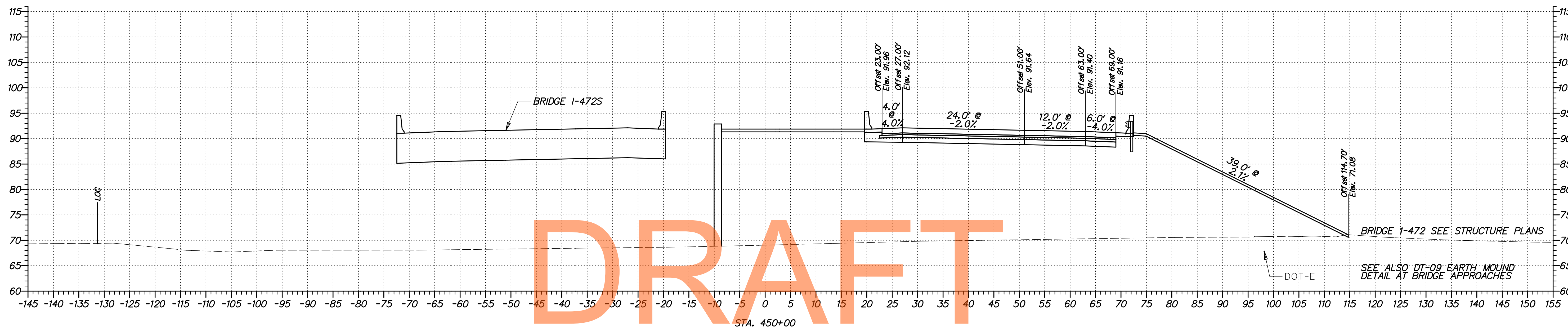

DRAFT

NOT FOR BIDDING
AUGUST 2015

G:\60049040 US301\CIVIL\PLANS\2A\XSEC\XS247.DGN

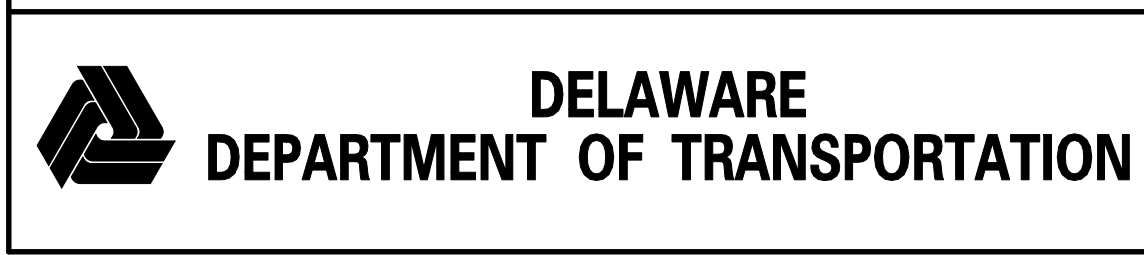

ADDENDUMS / REVISIONS	

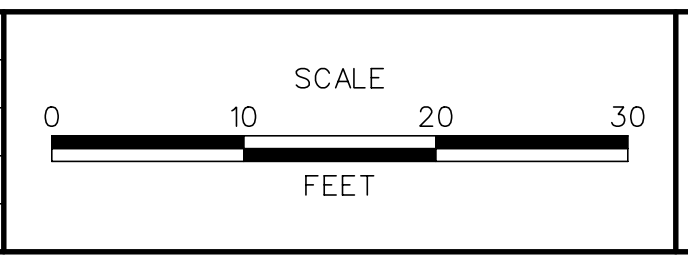

US 301
LEVELS ROAD
TO SUMMIT BRIDGE ROAD

CONTRACT	BRIDGE NO.
T20091303	
COUNTY	DESIGNED BY: SS
NEW CASTLE	CHECKED BY: AM

CROSS SECTIONS
US 301 MAINLINE
STA. 450 + 00

SHEET NO.
264
TOTAL SHTS.
518

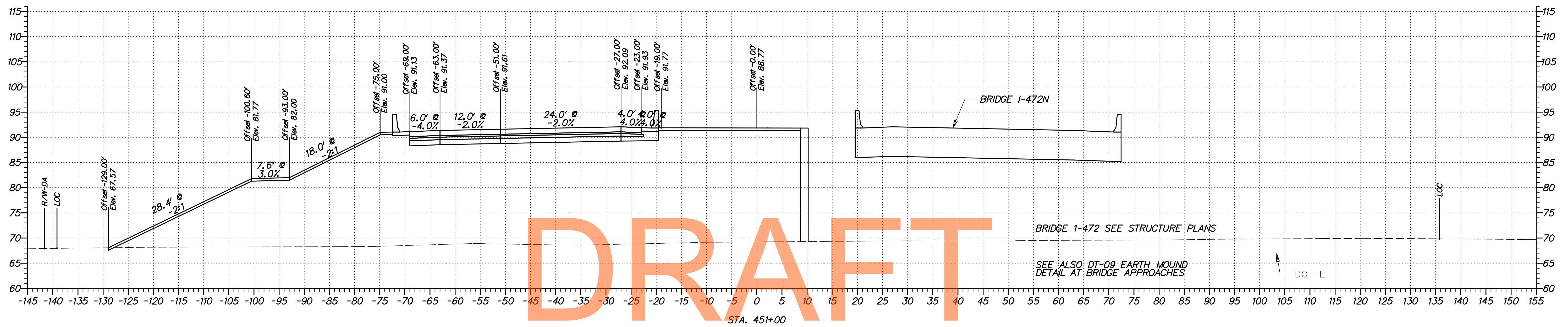

DRAFT
 NOT FOR BIDDING
 AUGUST 2015

G:\60049040 US301\CIVIL\PLANS\2A\XSEC\XS249.DGN

DELAWARE DEPARTMENT OF TRANSPORTATION	ADDENDUMS / REVISIONS	SCALE FEET	US 301 LEVELS ROAD TO SUMMIT BRIDGE ROAD	CONTRACT T20091303	BRIDGE NO.	CROSS SECTIONS US 301 MAINLINE STA. 451 + 00	SHEET NO. 265
					COUNTY NEW CASTLE		DESIGNED BY: SS CHECKED BY: AM

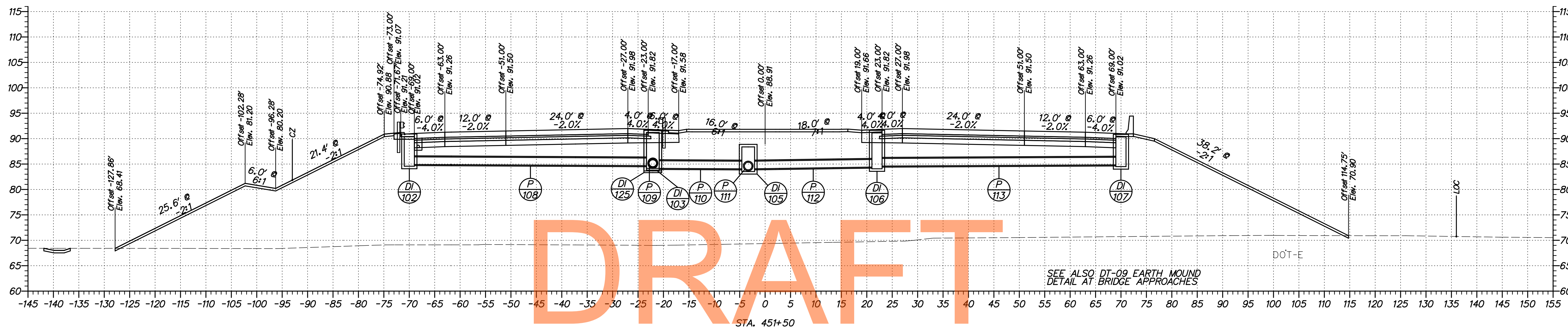

DRAFT

NOT FOR BIDDING
AUGUST 2015

G:\60049040 US301\CIVIL\PLANS\2A\XSEC\XS250.DGN

<p>DELAWARE DEPARTMENT OF TRANSPORTATION</p>	ADDENDUMS / REVISIONS	<p>SCALE</p> <p>FEET</p>	<p>US 301 LEVELS ROAD TO SUMMIT BRIDGE ROAD</p>		<p>CONTRACT T20091303</p>	<p>BRIDGE NO.</p>	<p>CROSS SECTIONS US 301 MAINLINE STA. 451 + 50</p>	<p>SHEET NO. 266</p>
				<p>COUNTY NEW CASTLE</p>	<p>DESIGNED BY: SS</p> <p>CHECKED BY: AM</p>	<p>TOTAL SHTS. 518</p>		

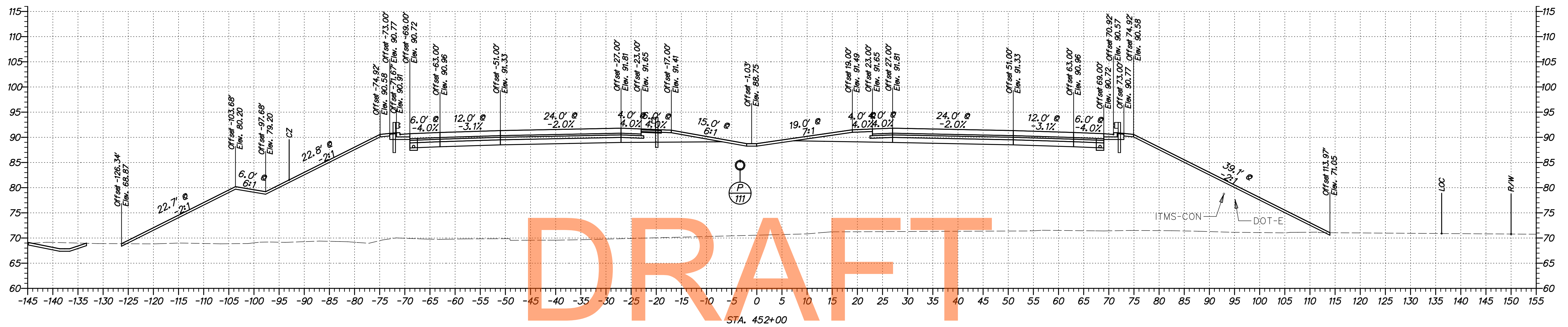

DRAFT

NOT FOR BIDDING

AUGUST 2015

G:\60049040 US301\CIVIL\PLANS\2A\XSEC\XS251.DGN

	DELAWARE DEPARTMENT OF TRANSPORTATION	ADDENDUMS / REVISIONS	SCALE 	US 301 LEVELS ROAD TO SUMMIT BRIDGE ROAD	CONTRACT T20091303	BRIDGE NO. DESIGNED BY: SS CHECKED BY: AM	CROSS SECTIONS US 301 MAINLINE STA. 452 + 00	SHEET NO. 267 TOTAL SHTS. 518
						COUNTY NEW CASTLE		

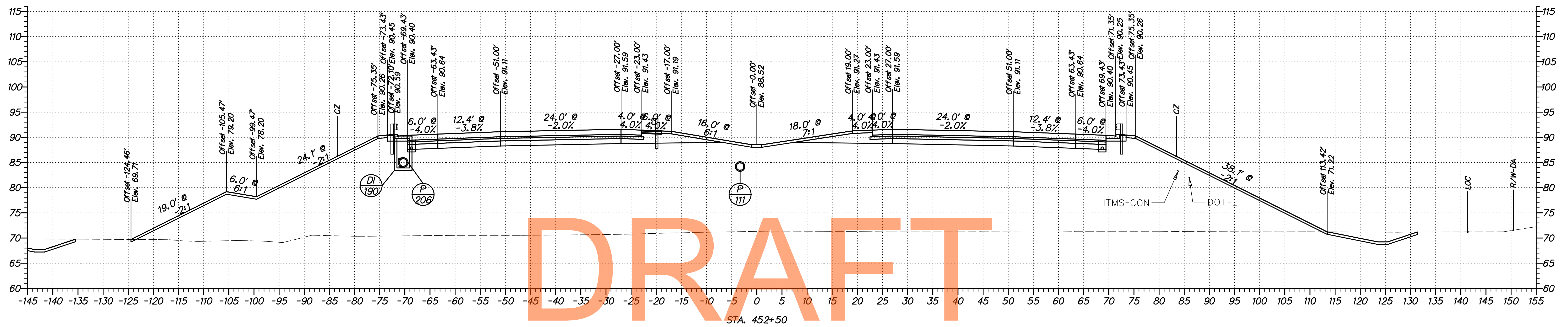

DRAFT

NOT FOR BIDDING

AUGUST 2015

G:\60049040 US301\CIVIL\PLANS\2A\XSEC\XS252.DGN

DELAWARE
DEPARTMENT OF TRANSPORTATION

ADDENDUMS / REVISIONS

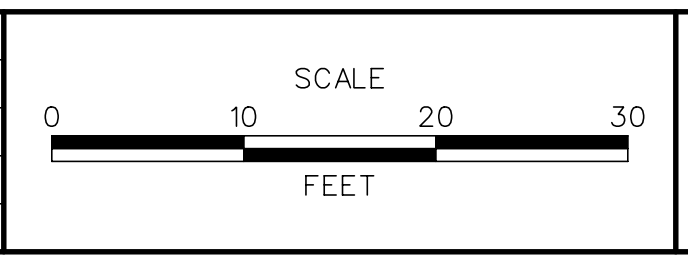

US 301
LEVELS ROAD
TO SUMMIT BRIDGE ROAD

CONTRACT	BRIDGE NO.
T20091303	
COUNTY	DESIGNED BY: SS
NEW CASTLE	CHECKED BY: AM

CROSS SECTIONS
US 301 MAINLINE
STA. 452 + 50

SHEET NO.
268
TOTAL SHTS.
518

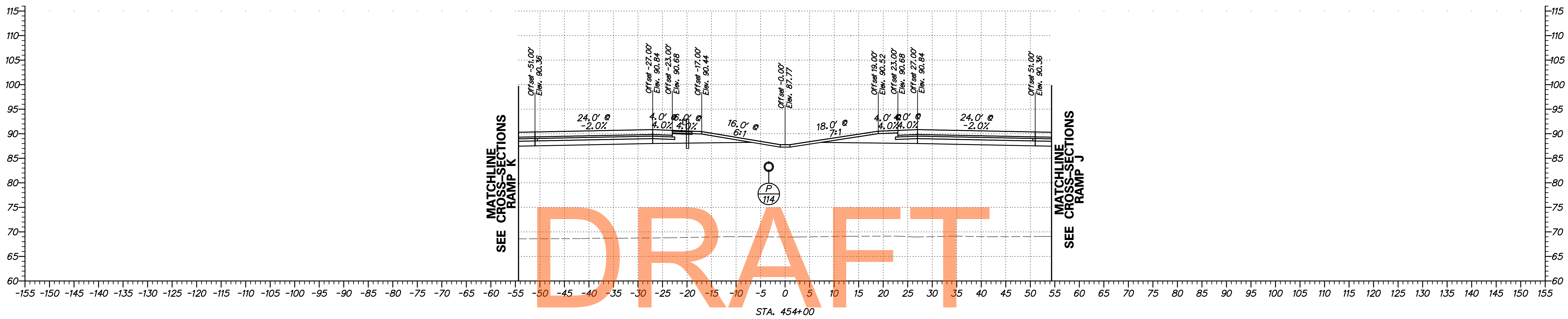

DRAFT

NOT FOR BIDDING

AUGUST 2015

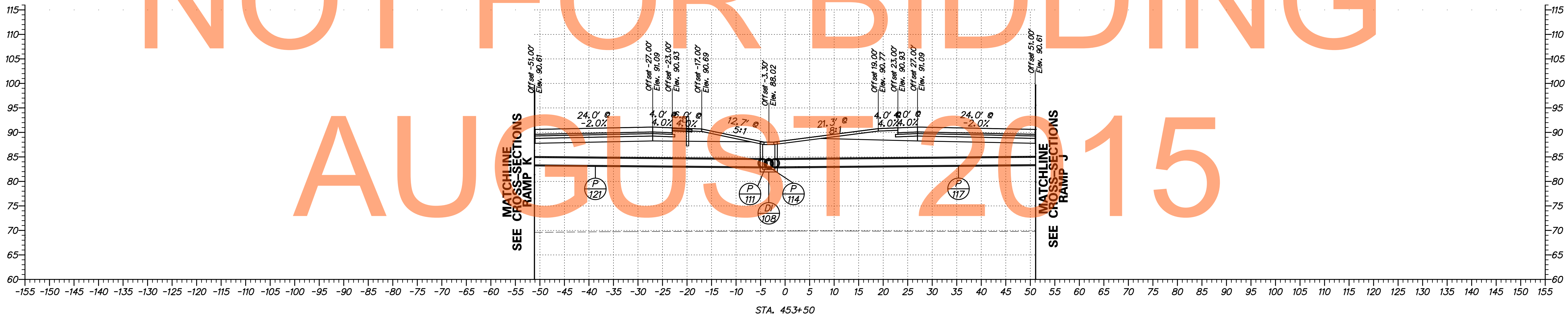

G:\60049040 US301\CIVIL\PLANS\2A\XSEC\XS254.DGN

DELAWARE DEPARTMENT OF TRANSPORTATION	ADDENDUMS / REVISIONS	SCALE FEET	US 301 LEVELS ROAD TO SUMMIT BRIDGE ROAD	CONTRACT	BRIDGE NO.	CROSS SECTIONS US 301 MAINLINE STA. 453 + 50 - STA. 454 + 00	SHEET NO.
					T20091303		
				COUNTY	CHECKED BY: AM	TOTAL SHTS.	518
				NEW CASTLE			

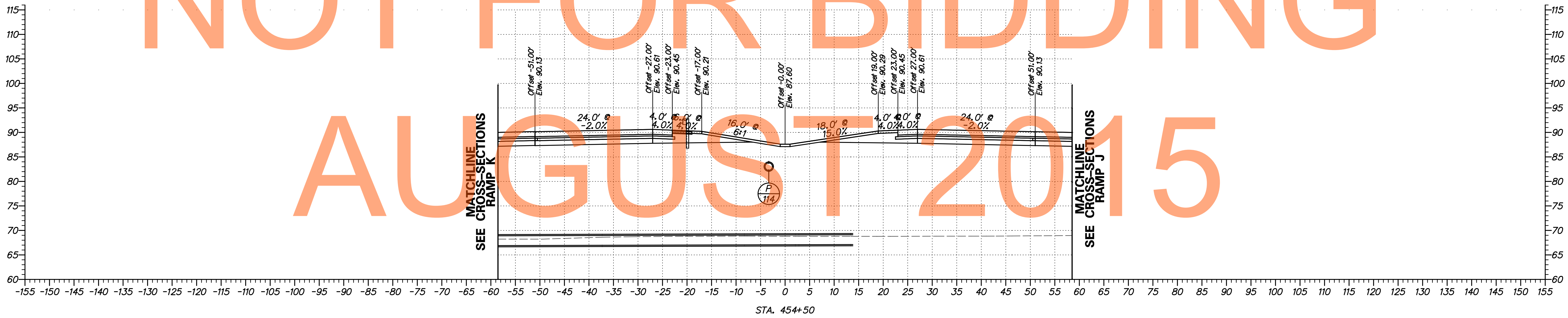
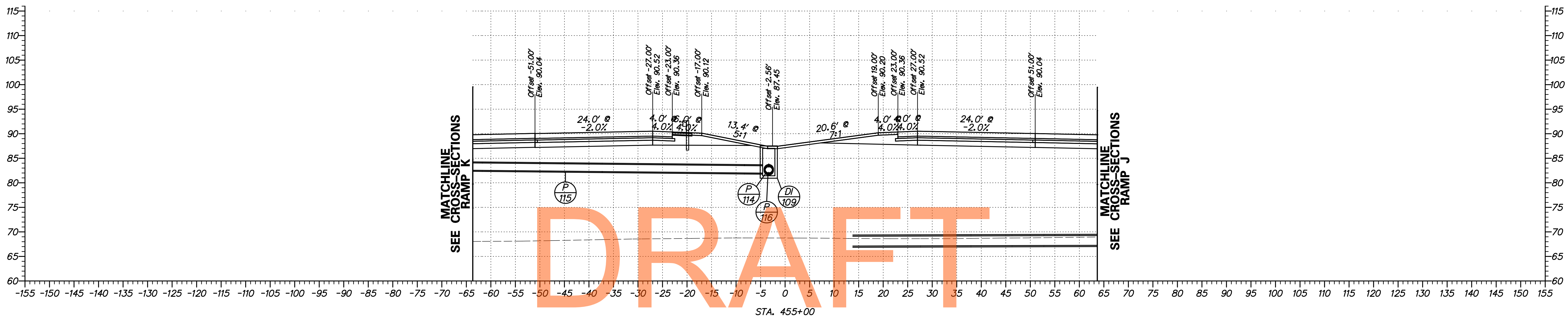

DRAFT

NOT FOR BIDDING

AUGUST 2015

G:\60049040 US301\CIVIL\PLANS\2A\XSEC\XS255.DGN

DELAWARE DEPARTMENT OF TRANSPORTATION	ADDENDUMS / REVISIONS	SCALE FEET	US 301 LEVELS ROAD TO SUMMIT BRIDGE ROAD	CONTRACT	BRIDGE NO.	CROSS SECTIONS US 301 MAINLINE STA. 454 + 50 - STA. 455 + 00	SHEET NO.
					T20091303		
				COUNTY	CHECKED BY: AM	TOTAL SHTS.	518
				NEW CASTLE			

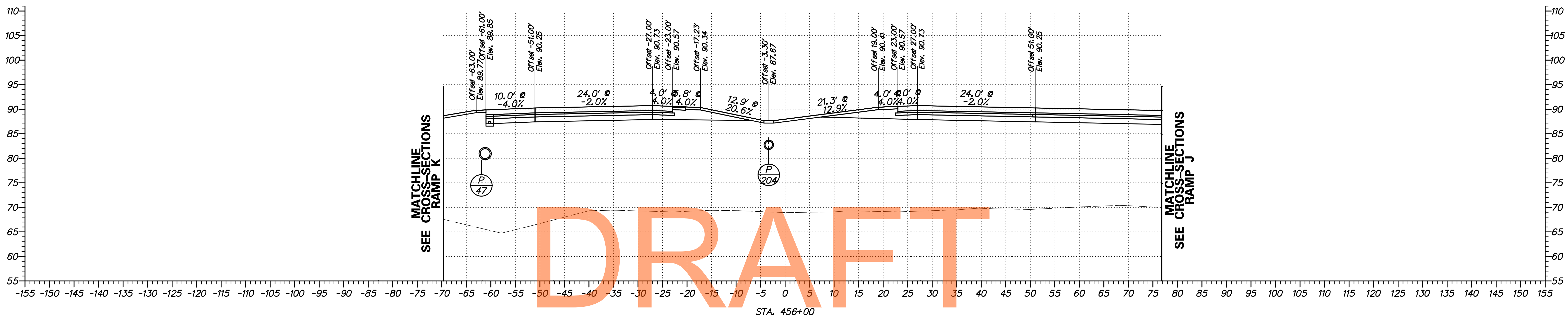

DRAFT

NOT FOR BIDDING

AUGUST 2015

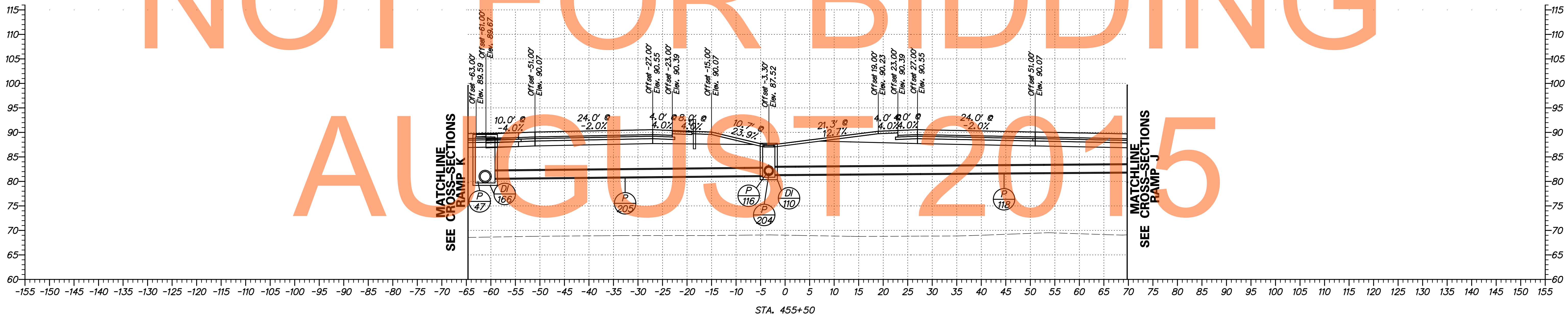

G:\60049040 US301\CIVIL\PLANS\2A\XSEC\XS256.DGN

DELAWARE DEPARTMENT OF TRANSPORTATION	ADDENDUMS / REVISIONS	SCALE FEET	US 301 LEVELS ROAD TO SUMMIT BRIDGE ROAD	CONTRACT T20091303	BRIDGE NO.	CROSS SECTIONS US 301 MAINLINE STA. 455 + 50 - STA. 456 + 00	SHEET NO. 272
					COUNTY NEW CASTLE		DESIGNED BY: SS

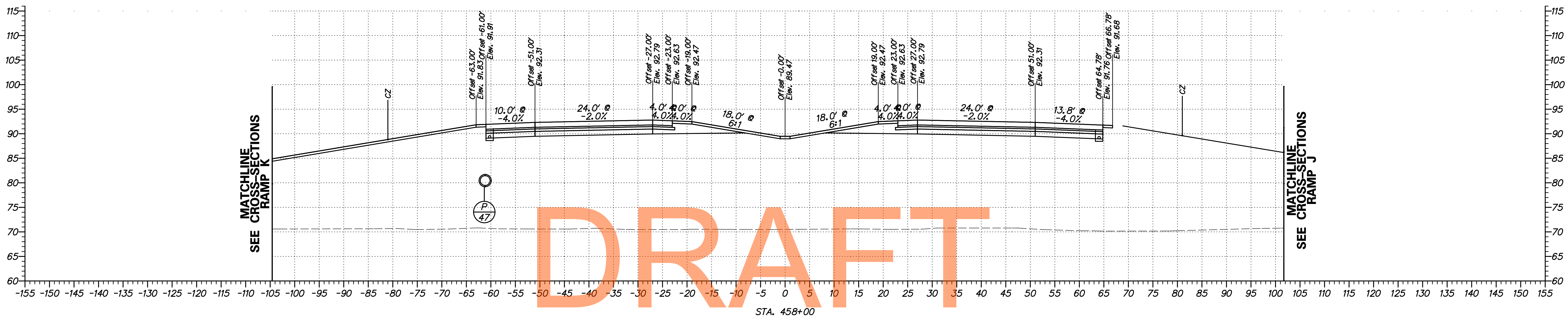

NOT FOR BIDDING

AUGUST 2015

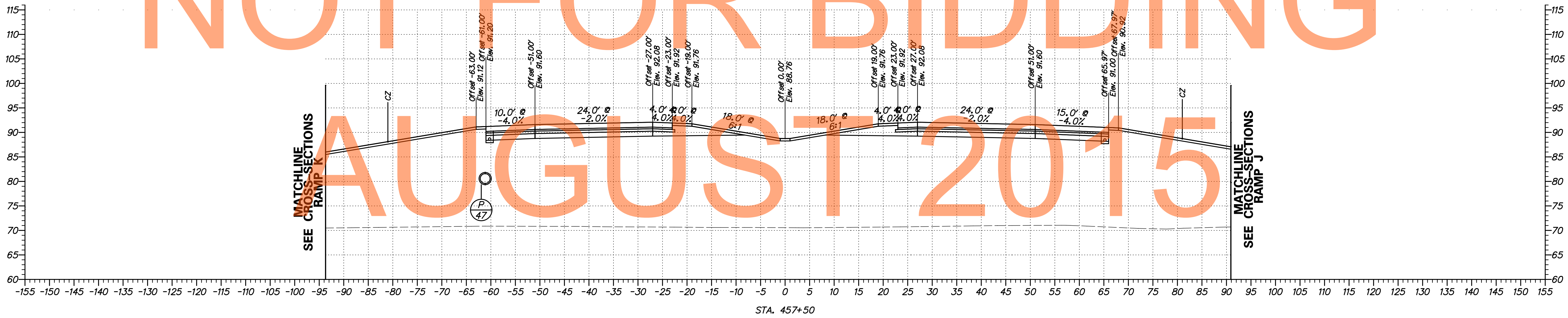

G:\60049040 US301\CIVIL\PLANS\2A\XSEC\XS258.DGN

DELAWARE DEPARTMENT OF TRANSPORTATION	ADDENDUMS / REVISIONS	SCALE FEET	US 301 LEVELS ROAD TO SUMMIT BRIDGE ROAD	CONTRACT T20091303	BRIDGE NO.	CROSS SECTIONS US 301 MAINLINE STA. 457+50 - STA. 458+00	SHEET NO. 274
					COUNTY NEW CASTLE		DESIGNED BY: SS

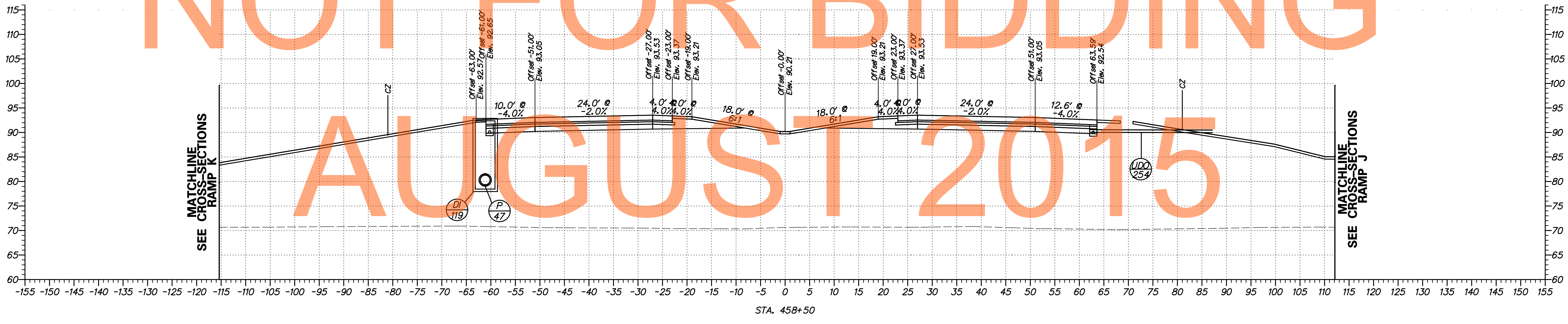
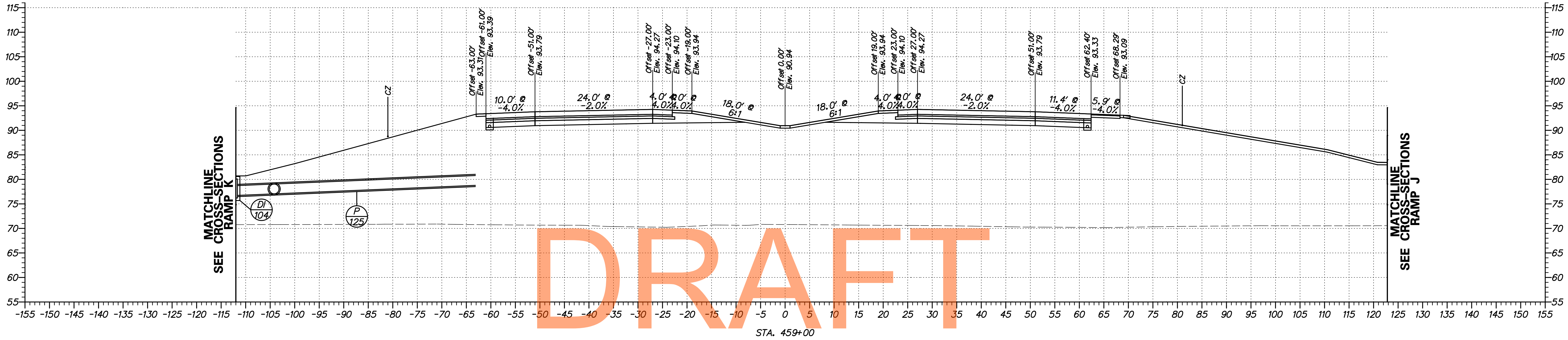

NOT FOR BIDDING
AUGUST 2015

G:\60049040 US301\CIVIL\PLANS\2A\XSEC\XS259.DGN

DELAWARE DEPARTMENT OF TRANSPORTATION	ADDENDUMS / REVISIONS	SCALE FEET	US 301 LEVELS ROAD TO SUMMIT BRIDGE ROAD	CONTRACT T20091303	BRIDGE NO.	CROSS SECTIONS US 301 MAINLINE STA. 458 + 50 - STA. 459 + 00	SHEET NO. 275
					COUNTY NEW CASTLE		DESIGNED BY: SS
				CHECKED BY: AM			

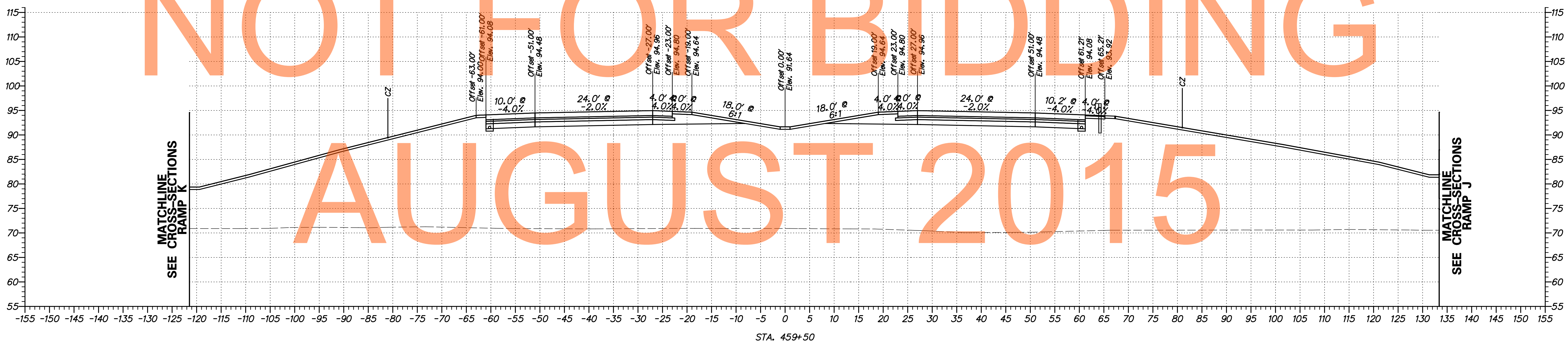
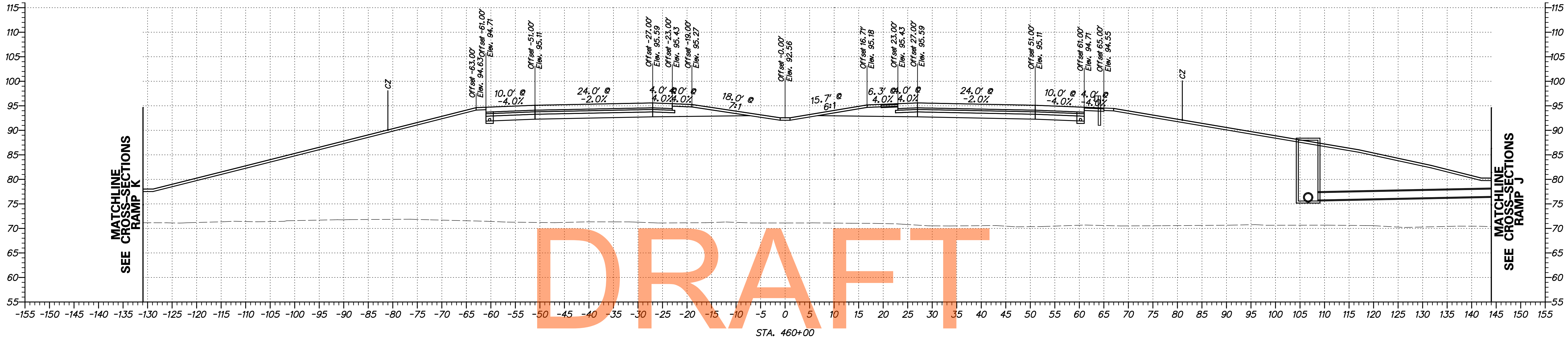

G:\60049040 US301\CIVIL\PLANS\2A\XSEC\XS260.DGN

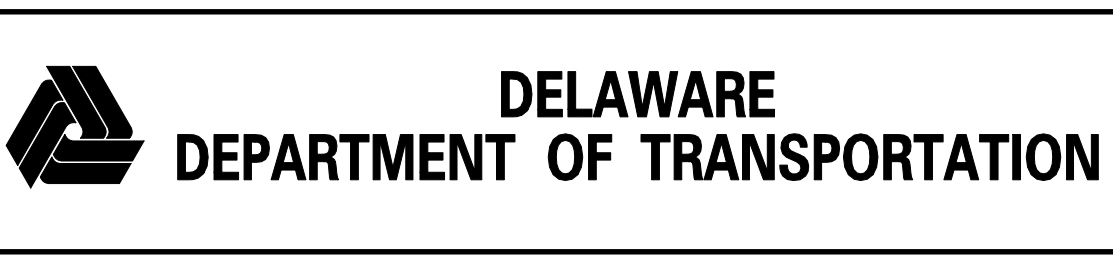

ADDENDUMS / REVISIONS	

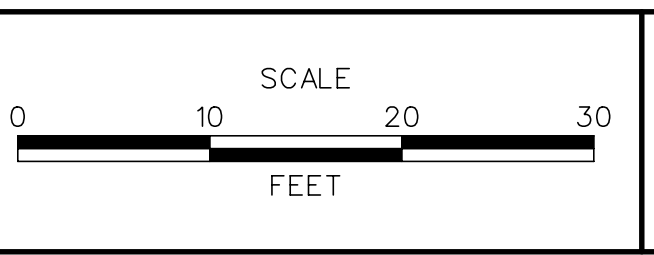

**US 301
LEVELS ROAD
TO SUMMIT BRIDGE ROAD**

CONTRACT	BRIDGE NO.
T20091303	
COUNTY	DESIGNED BY: SS
NEW CASTLE	CHECKED BY: AM

**CROSS SECTIONS
US 301 MAINLINE
STA. 459+50 - STA. 460+00**

SHEET NO.
276
TOTAL SHTS.
518

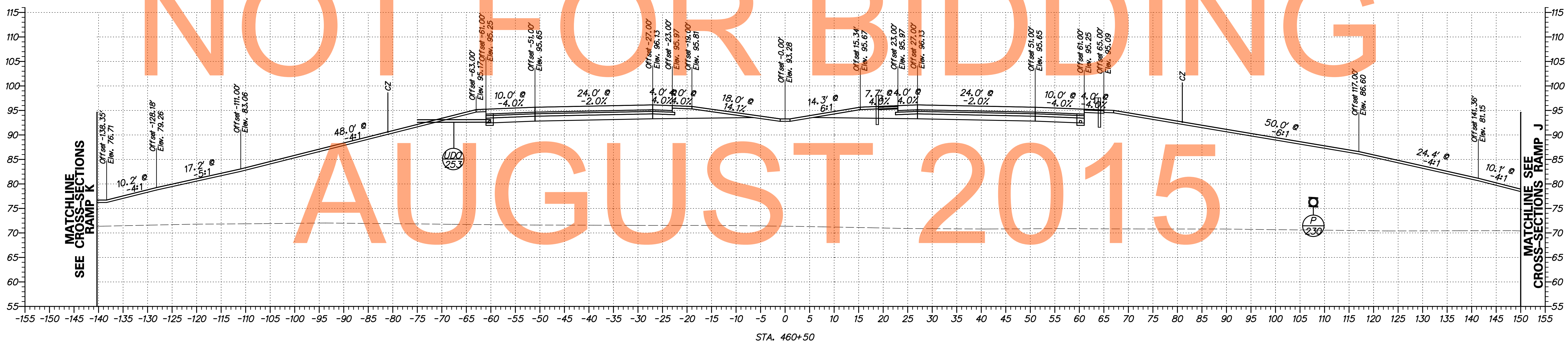
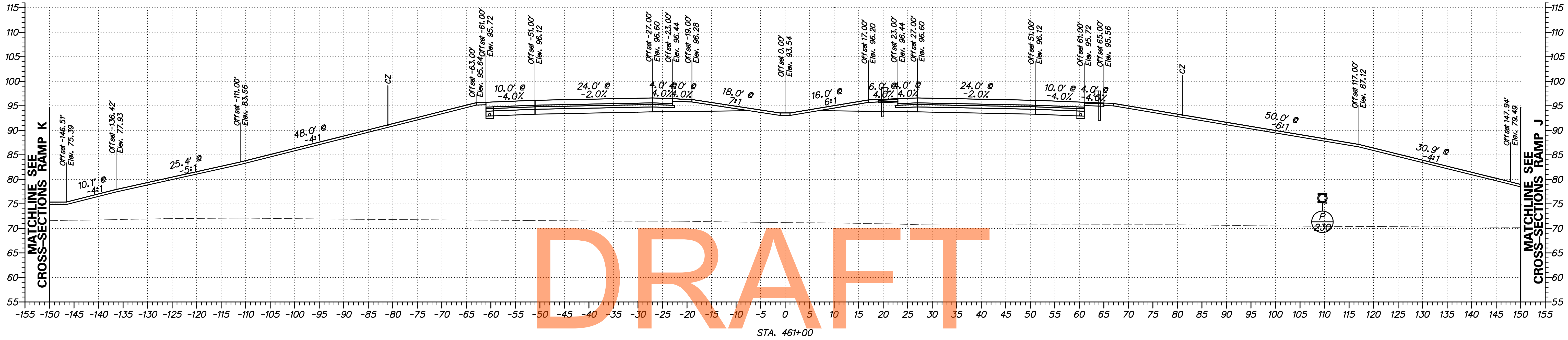

DRAFT

NOT FOR BIDDING

AUGUST 2015

G:\60049040 US301\CIVIL\PLANS\2A\XSEC\XS261.DGN



ADDENDUMS / REVISIONS	

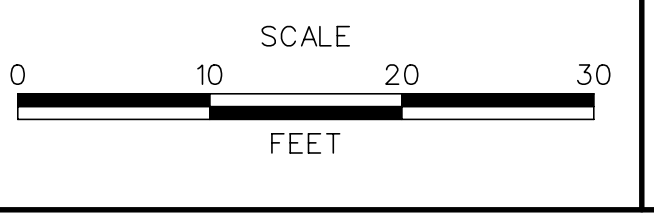

**US 301
LEVELS ROAD
TO SUMMIT BRIDGE ROAD**

CONTRACT	BRIDGE NO.
T200911303	
COUNTY	DESIGNED BY: SS
NEW CASTLE	CHECKED BY: AM

**CROSS SECTIONS
US 301 MAINLINE
STA. 460+50 - STA. 461+00**

SHEET NO.
277
TOTAL SHTS.
518

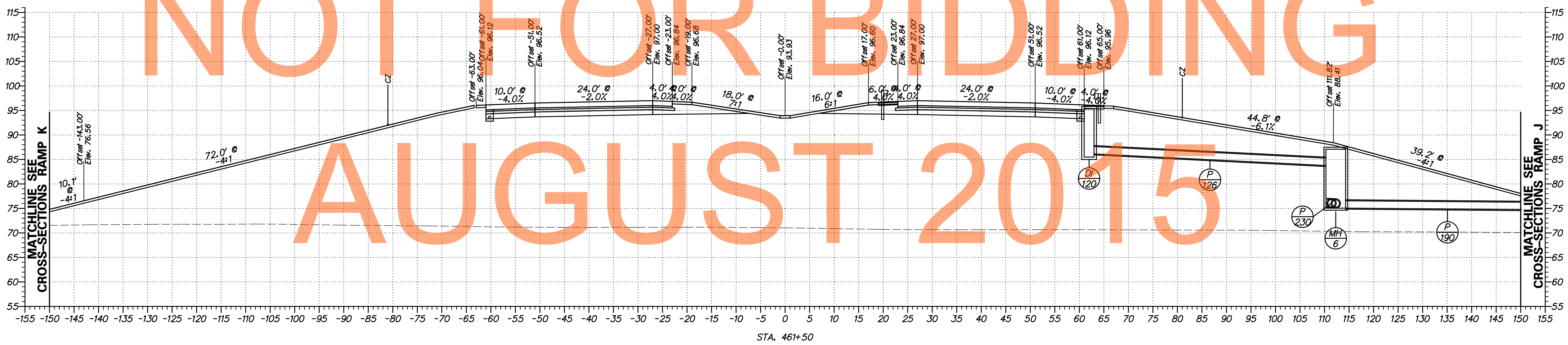
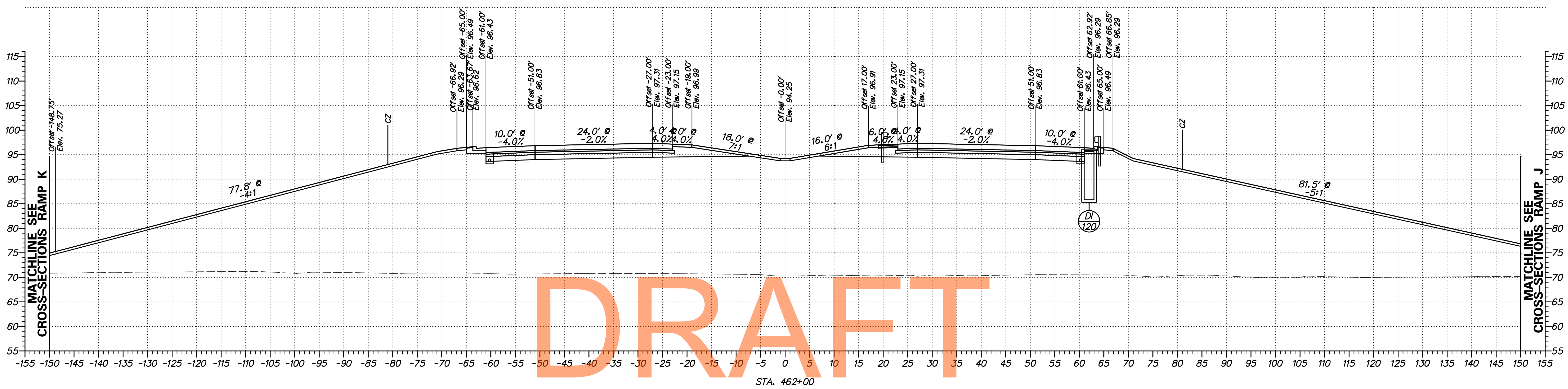

DRAFT

NOT FOR BIDDING

AUGUST 2015

G:\60049040 US301\CIVIL\PLANS\2A\XSEC\X262.DGN

DELAWARE DEPARTMENT OF TRANSPORTATION	ADDENDUMS / REVISIONS		US 301 LEVELS ROAD TO SUMMIT BRIDGE ROAD	CONTRACT T20091303	BRIDGE NO.	CROSS SECTIONS US 301 MAINLINE STA. 461+50 - STA. 462+00	SHEET NO. 278
					COUNTY NEW CASTLE		DESIGNED BY: SS

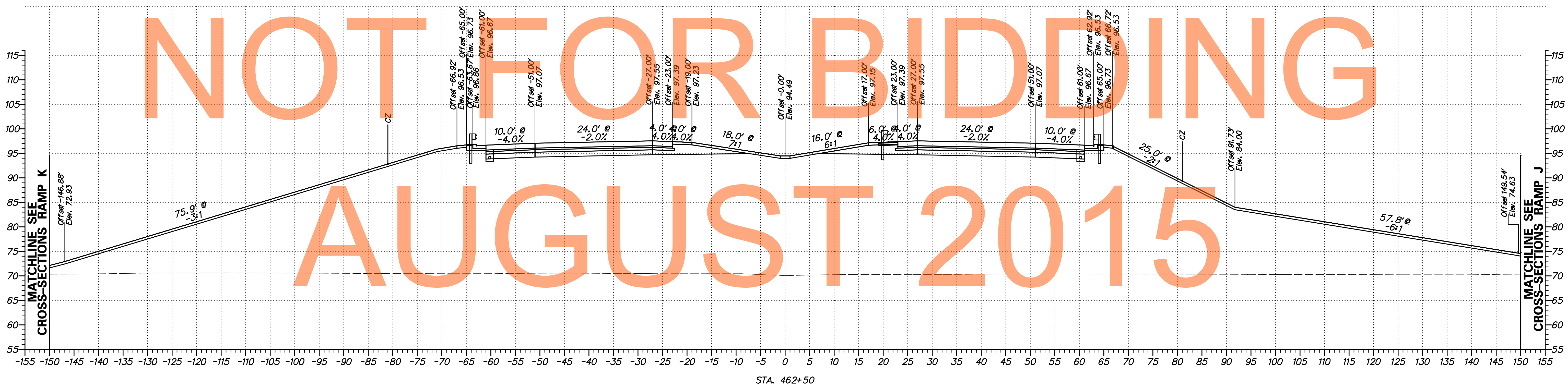
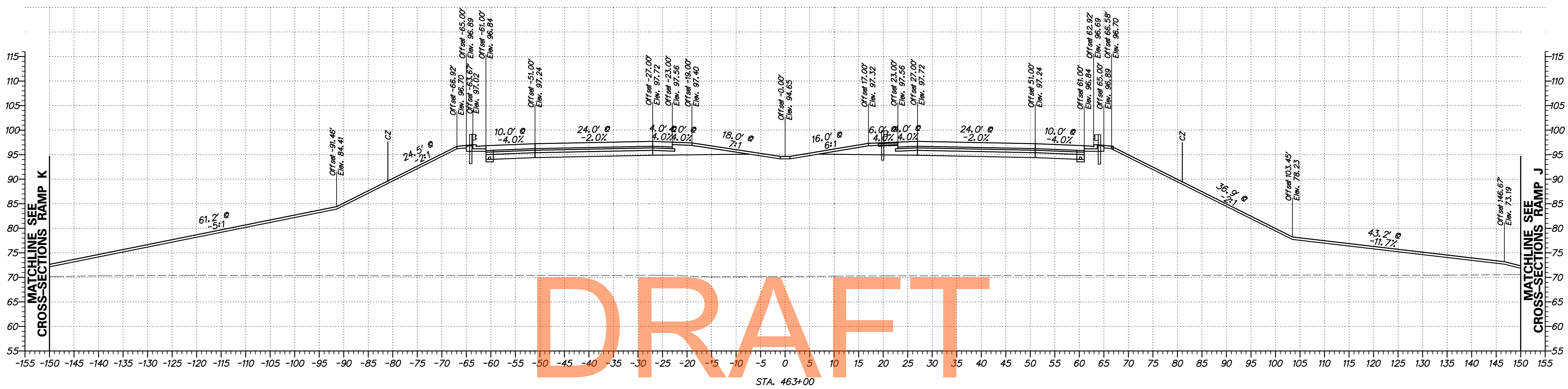

DRAFT

NOT FOR BIDDING

AUGUST 2015

G:\60049040 US301\CIVIL\PLANS\2A\XSEC\X263.DGN

DELAWARE DEPARTMENT OF TRANSPORTATION	ADDENDUMS / REVISIONS	SCALE FEET	US 301 LEVELS ROAD TO SUMMIT BRIDGE ROAD	CONTRACT T20091303	BRIDGE NO.	CROSS SECTIONS US 301 MAINLINE STA. 462+50 - STA. 463+00	SHEET NO. 279
					COUNTY NEW CASTLE		DESIGNED BY: SS
				CHECKED BY: AM			

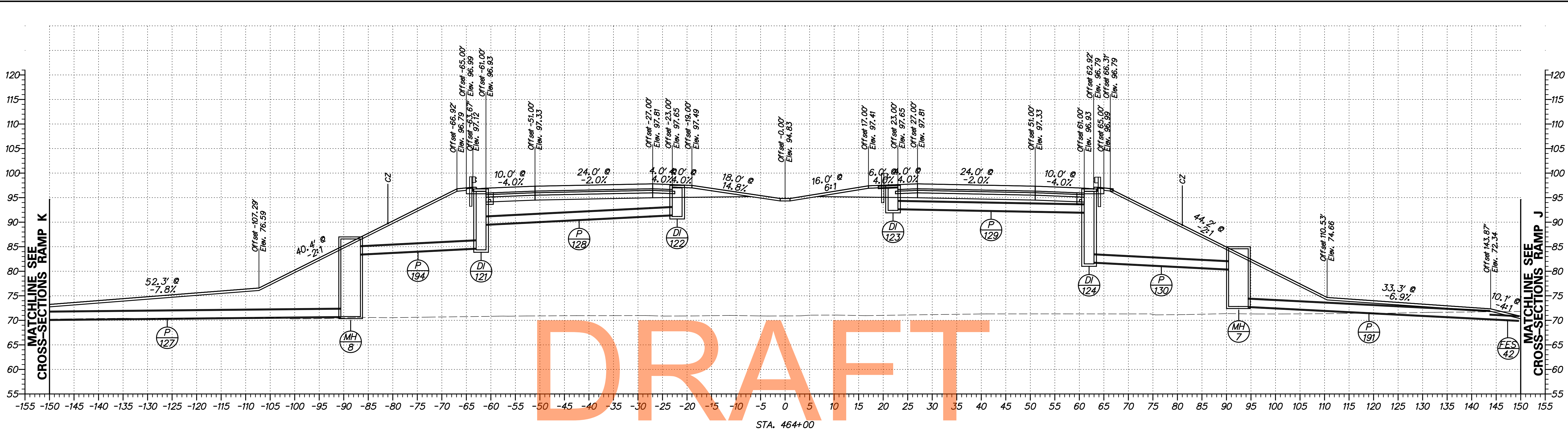

STA. 464+00

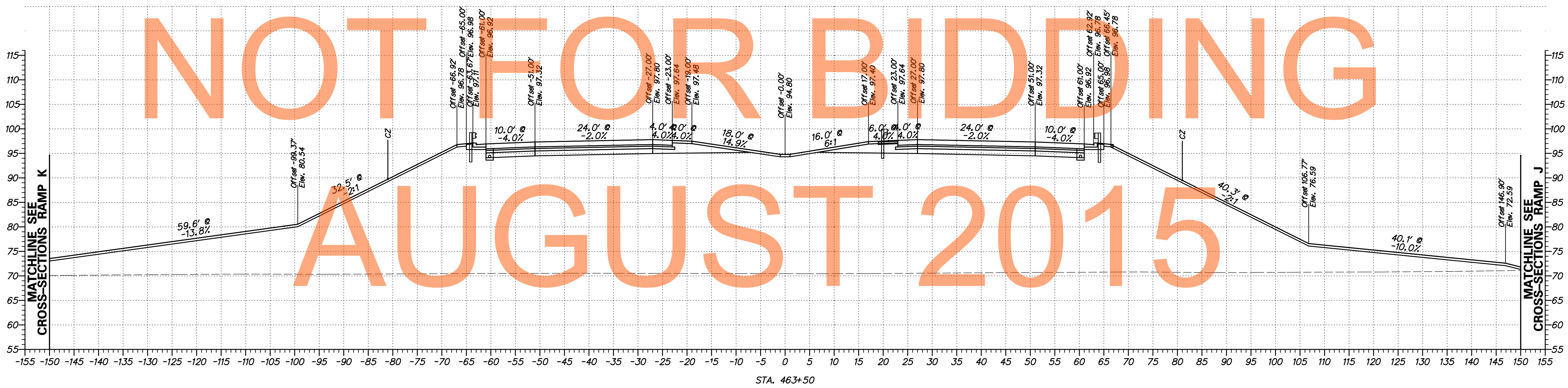

STA. 463+50

NOT FOR BIDDING
AUGUST 2015

G:\60049040 US301\CIVIL\PLANS\2A\XSEC\XS264.DGN

DELAWARE DEPARTMENT OF TRANSPORTATION	ADDENDUMS / REVISIONS	SCALE FEET	US 301 LEVELS ROAD TO SUMMIT BRIDGE ROAD	CONTRACT T200911303	BRIDGE NO.	CROSS SECTIONS US 301 MAINLINE STA. 463+50 - STA. 464+00	SHEET NO. 280
					COUNTY NEW CASTLE		DESIGNED BY: SS
				CHECKED BY: AM			

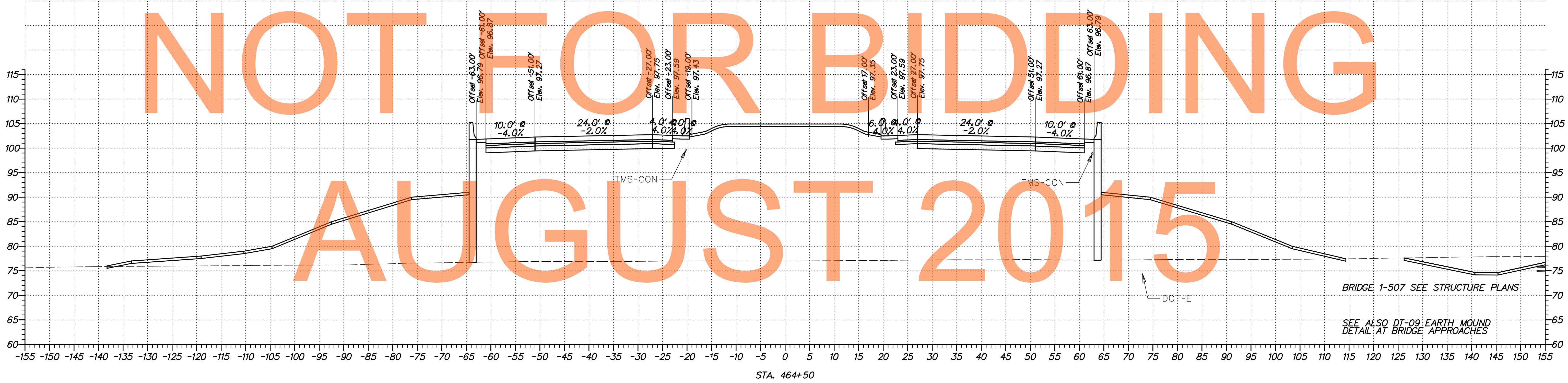
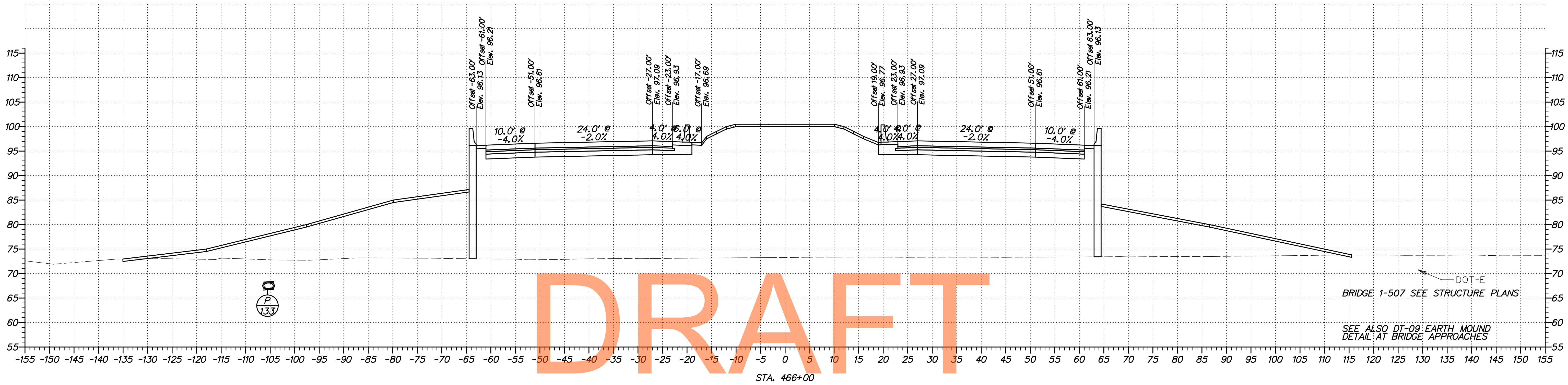

G:\60049040 US301\CIVIL\PLANS\2A\XSEC\X265.DGN

ADDENDUMS / REVISIONS	

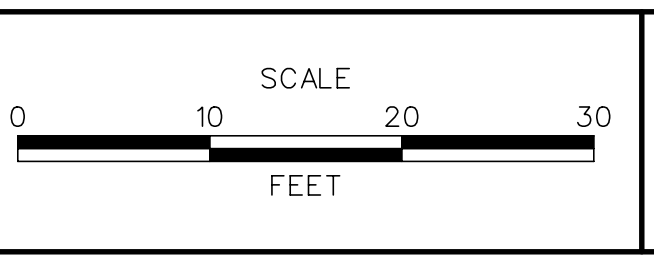

CONTRACT T20091303	BRIDGE NO.
COUNTY NEW CASTLE	DESIGNED BY: SS
	CHECKED BY: AM

SHEET NO. 281
TOTAL SHTS. 518

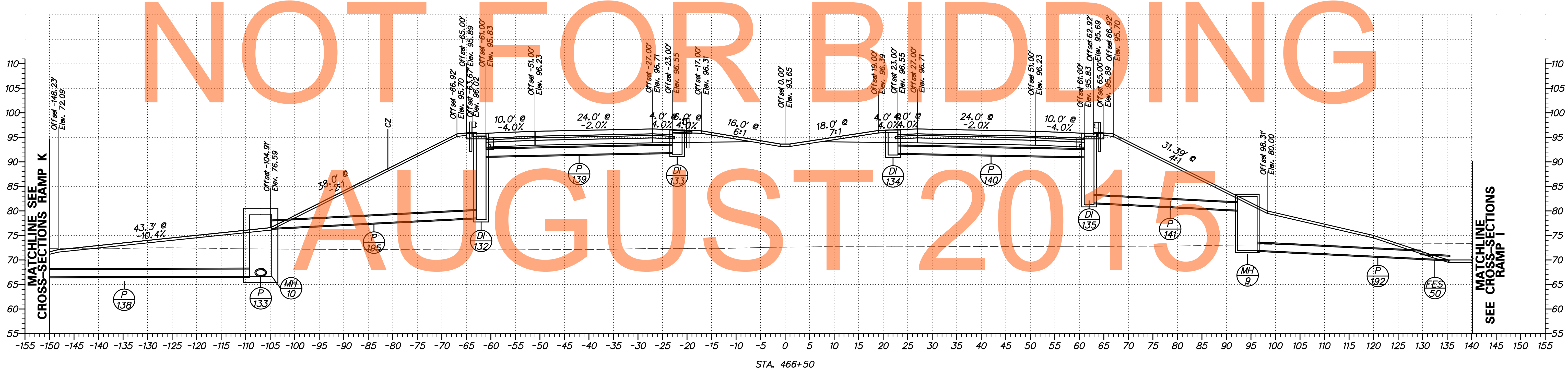
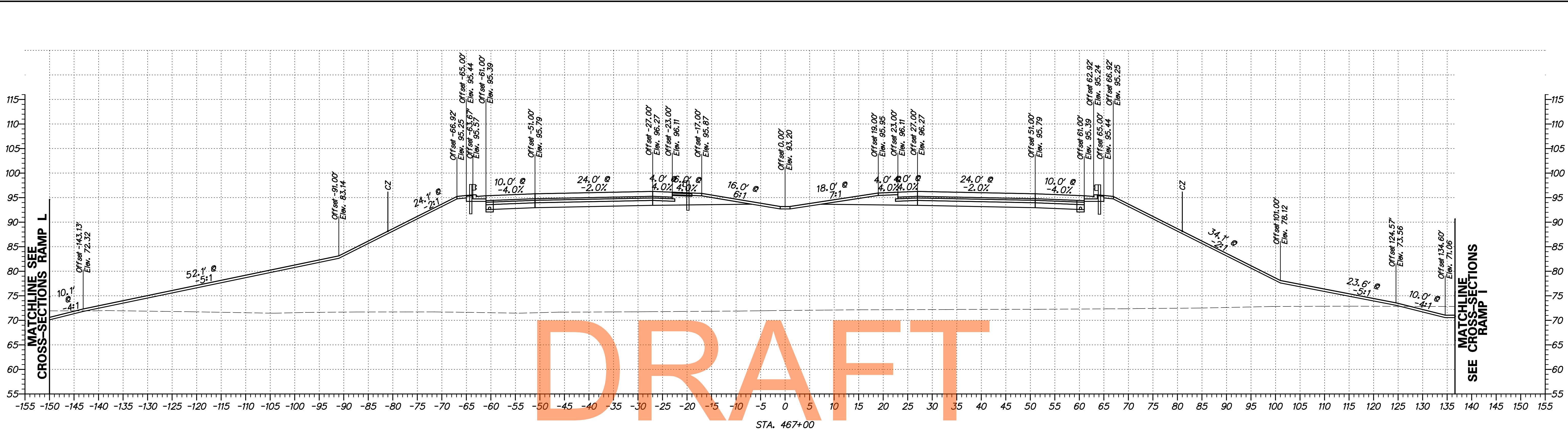

DRAFT

NOT FOR BIDDING

AUGUST 2015

G:\60049040 US301\CIVIL\PLANS\2A\XSEC\XS267.DGN

DELAWARE DEPARTMENT OF TRANSPORTATION	ADDENDUMS / REVISIONS	SCALE FEET	US 301 LEVELS ROAD TO SUMMIT BRIDGE ROAD	CONTRACT T200911303	BRIDGE NO.	CROSS SECTIONS US 301 MAINLINE STA. 466 + 50 - STA. 467 + 00	SHEET NO. 282
					COUNTY NEW CASTLE		DESIGNED BY: SS
				CHECKED BY: AM			

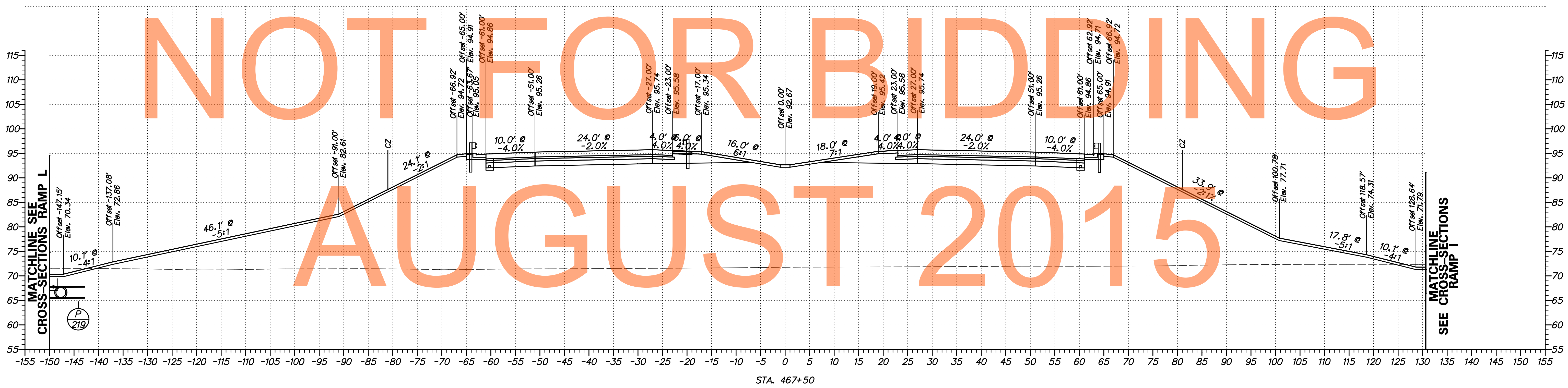
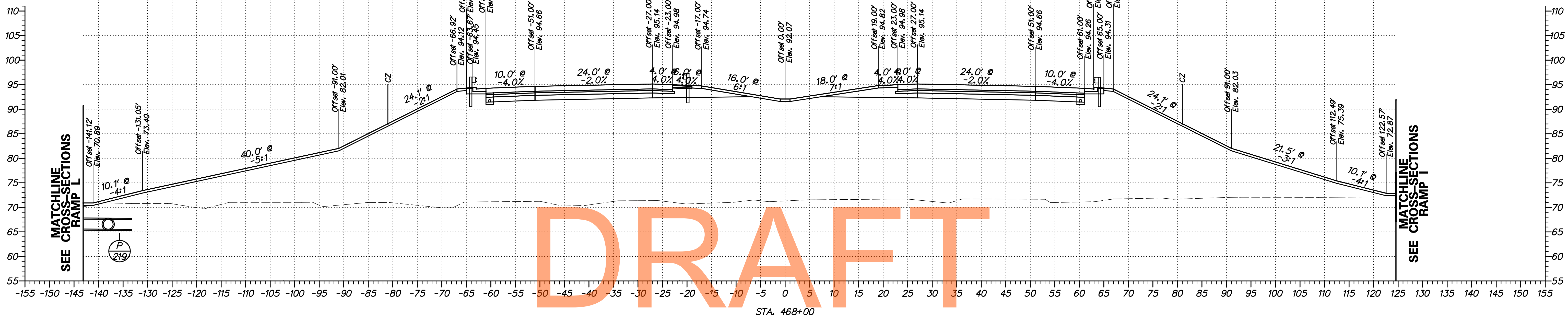

NOT FOR BIDDING
AUGUST 2015

G:\60049040 US301\CIVIL\PLANS\2A\XSEC\XS268.DGN

DELAWARE DEPARTMENT OF TRANSPORTATION	ADDENDUMS / REVISIONS	SCALE FEET	US 301 LEVELS ROAD TO SUMMIT BRIDGE ROAD	CONTRACT T20091303	BRIDGE NO.	CROSS SECTIONS US 301 MAINLINE STA. 467 + 50 - STA. 468 + 00	SHEET NO. 283
					COUNTY NEW CASTLE		DESIGNED BY: SS

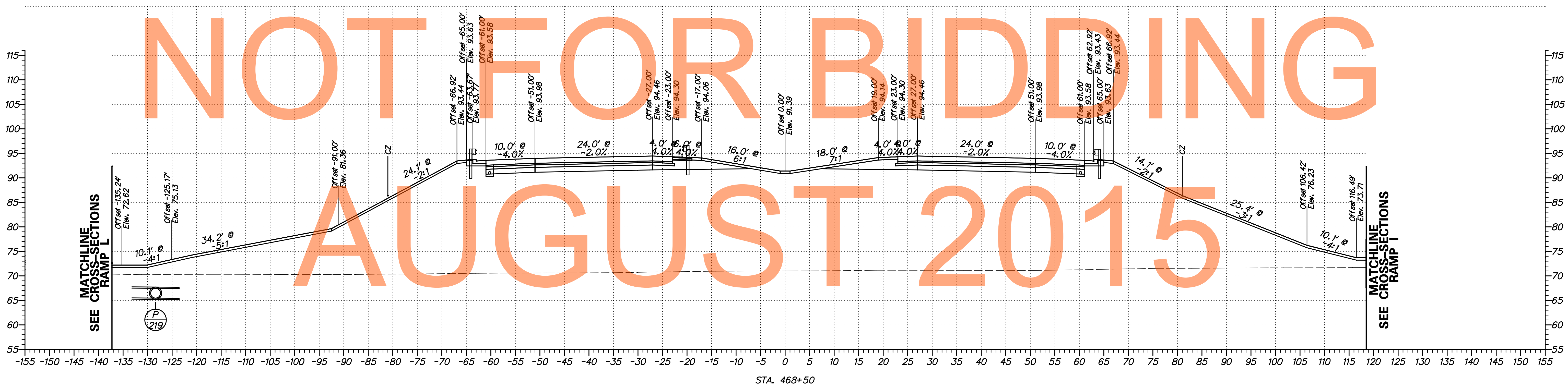
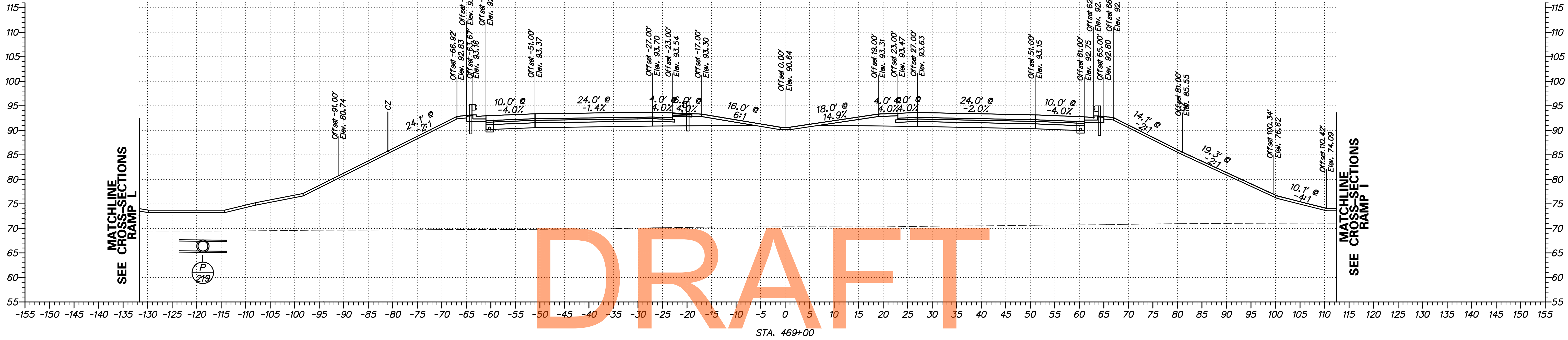

NOT FOR BIDDING
AUGUST 2015

G:\60049040 US301\CIVIL\PLANS\2A\XSEC\XS269.DGN

DELAWARE DEPARTMENT OF TRANSPORTATION	ADDENDUMS / REVISIONS		US 301 LEVELS ROAD TO SUMMIT BRIDGE ROAD	CONTRACT	BRIDGE NO.	CROSS SECTIONS US 301 MAINLINE STA. 468+50 - STA. 469+00	SHEET NO.
					T200911303		
				COUNTY	CHECKED BY: AM	TOTAL SHTS.	518
				NEW CASTLE			

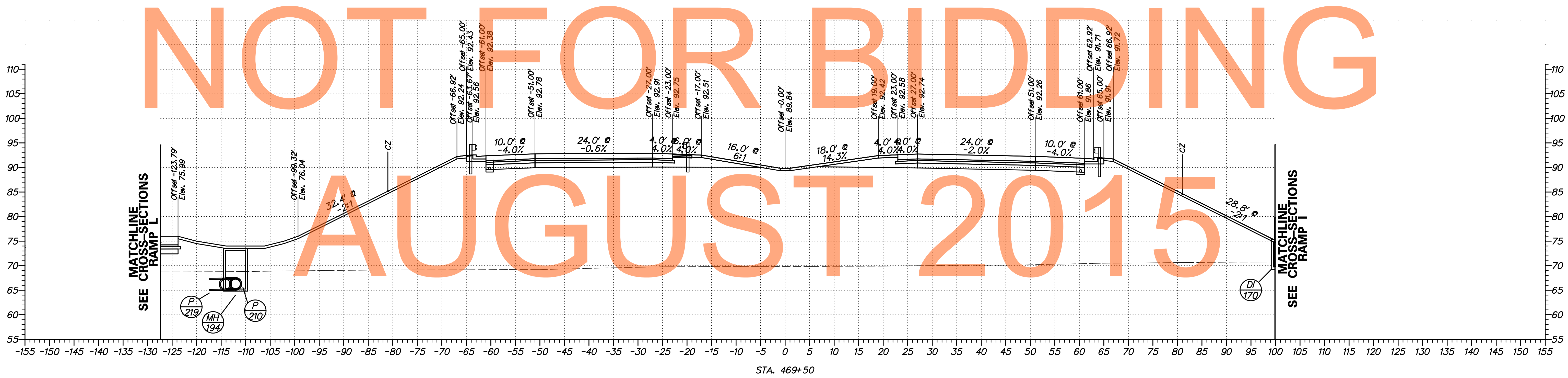
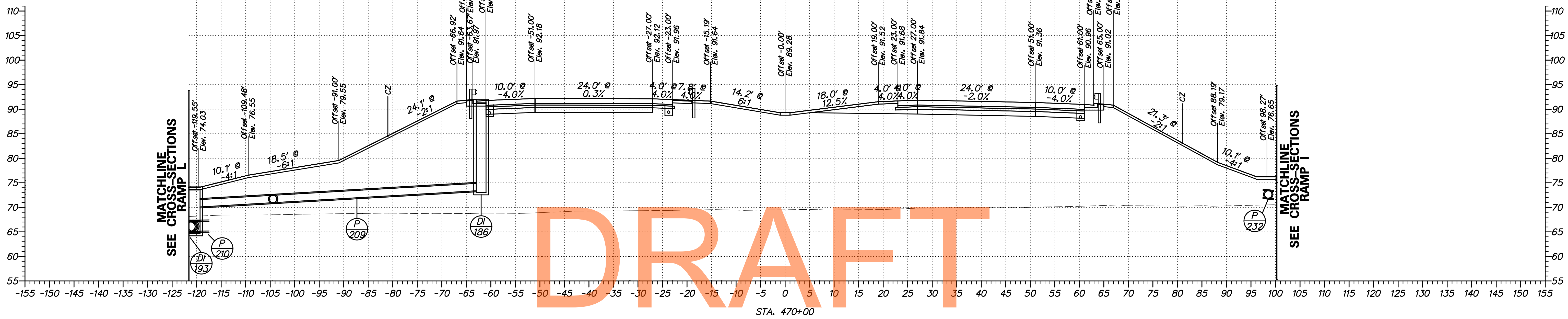

DRAFT

NOT FOR BIDDING

AUGUST 2015

G:\60049040 US301\CIVIL\PLANS\2A\XSEC\XS270.DGN

	DELAWARE DEPARTMENT OF TRANSPORTATION	ADDENDUMS / REVISIONS <table border="1" style="width: 100%; height: 20px;"> <tr><td> </td><td> </td></tr> </table>			SCALE 	US 301 LEVELS ROAD TO SUMMIT BRIDGE ROAD	CONTRACT T200911303 COUNTY NEW CASTLE	BRIDGE NO. DESIGNED BY: SS CHECKED BY: AM	CROSS SECTIONS US 301 MAINLINE STA. 469+50 - STA. 470+00	SHEET NO. 285 TOTAL SHTS. 518

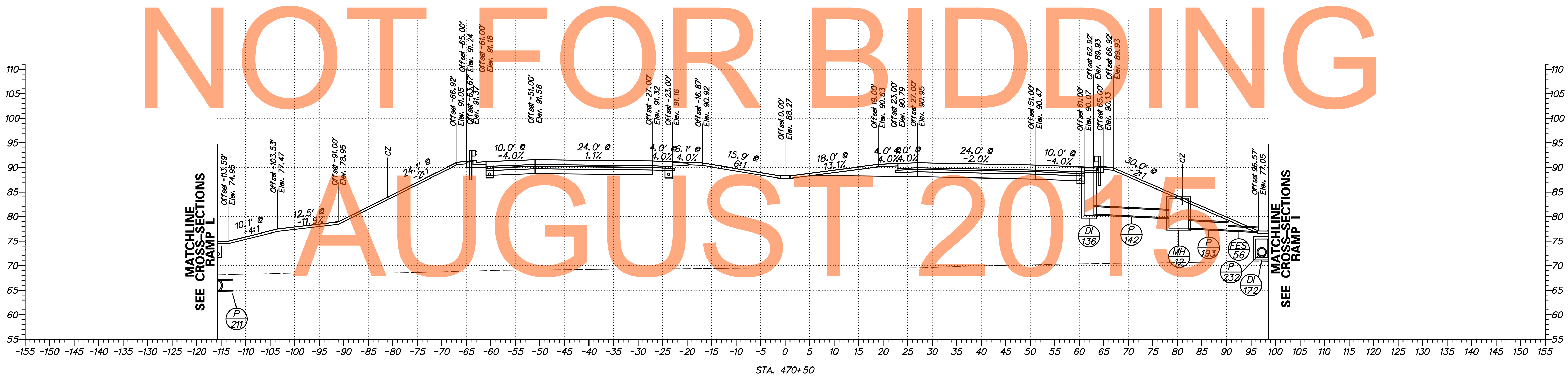
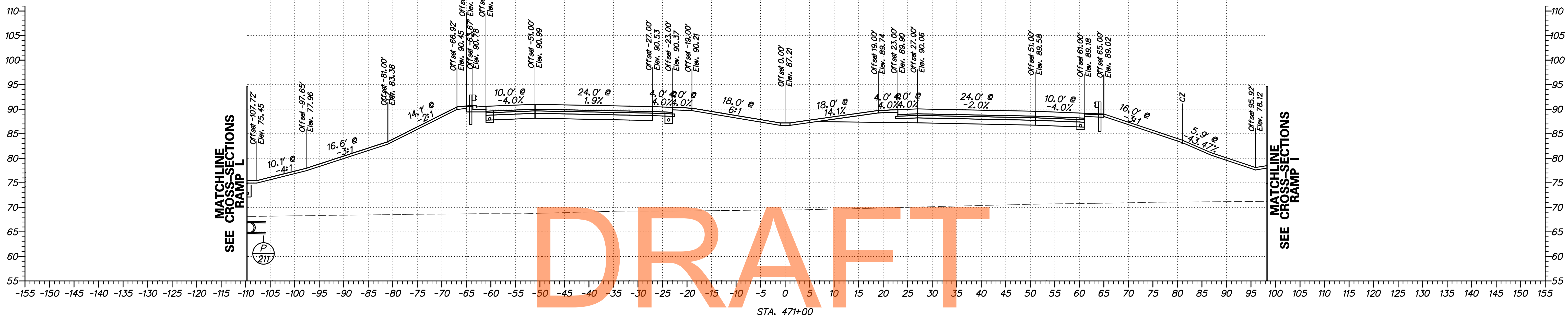

NOT FOR BIDDING
AUGUST 2015

G:\60049040 US301\CIVIL\PLANS\2A\XSEC\XS271.DGN

DELAWARE DEPARTMENT OF TRANSPORTATION	ADDENDUMS / REVISIONS	SCALE FEET	US 301 LEVELS ROAD TO SUMMIT BRIDGE ROAD	CONTRACT T20091303	BRIDGE NO.	CROSS SECTIONS US 301 MAINLINE STA. 470+50 - STA. 471+00	SHEET NO. 286
					COUNTY NEW CASTLE		DESIGNED BY: SS
				CHECKED BY: AM			

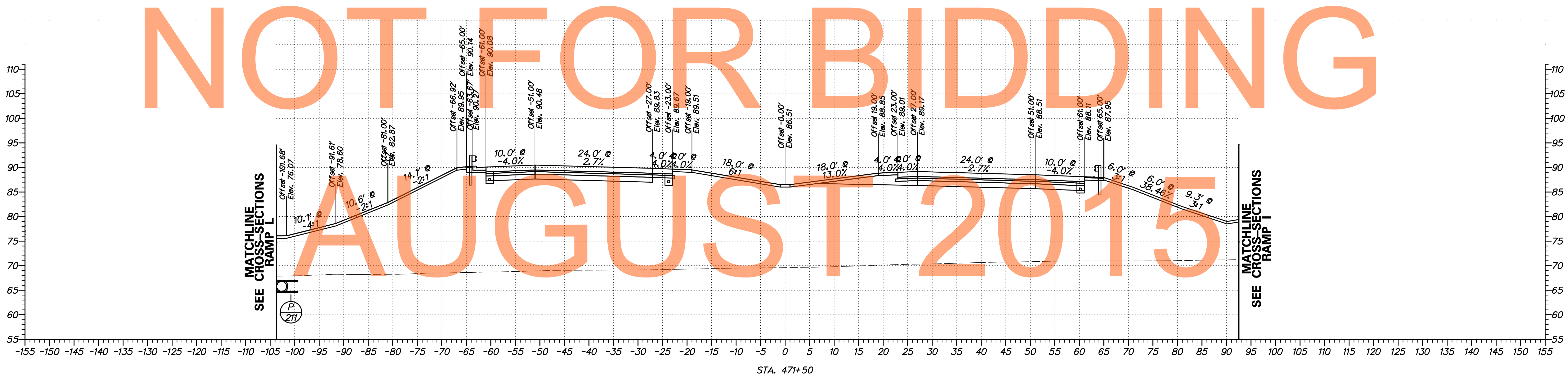
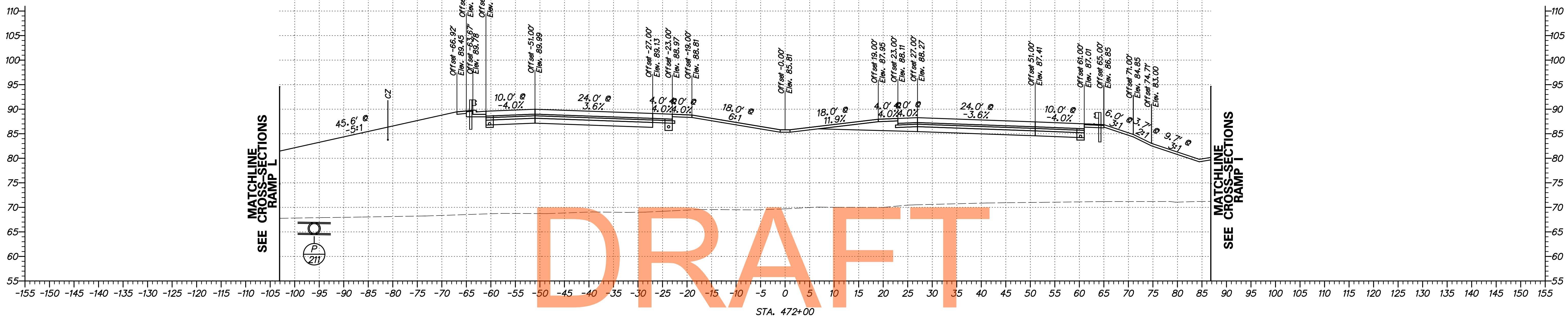

NOT FOR BIDDING

AUGUST 2015

G:\60049040 US301\CIVIL\PLANS\2A\XSEC\XS272.DGN

DELAWARE DEPARTMENT OF TRANSPORTATION	ADDENDUMS / REVISIONS	SCALE FEET	US 301 LEVELS ROAD TO SUMMIT BRIDGE ROAD	CONTRACT T20091303	BRIDGE NO.	CROSS SECTIONS US 301 MAINLINE STA. 471+50 - STA. 472+00	SHEET NO. 287
					COUNTY NEW CASTLE		DESIGNED BY: SS

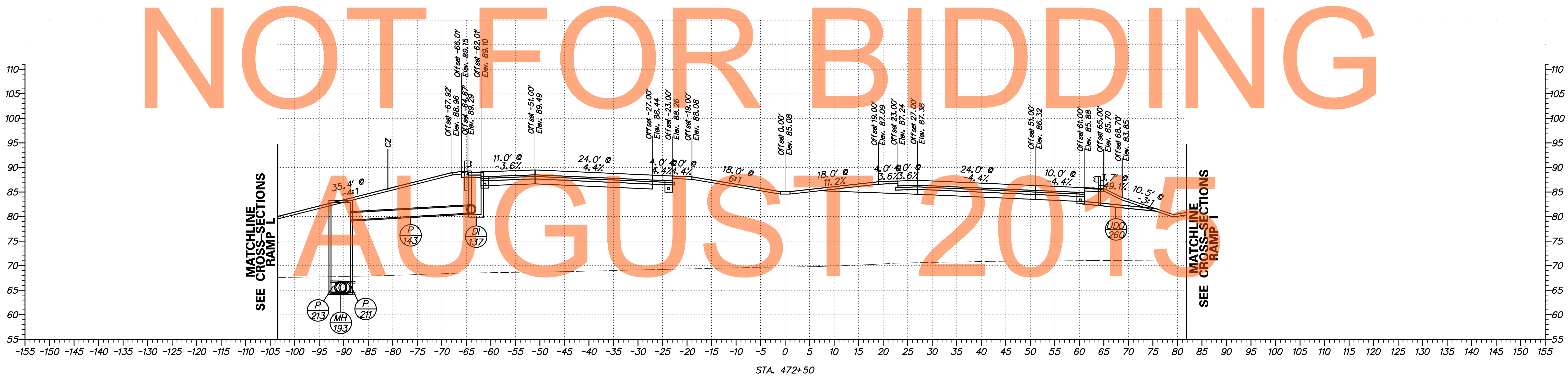
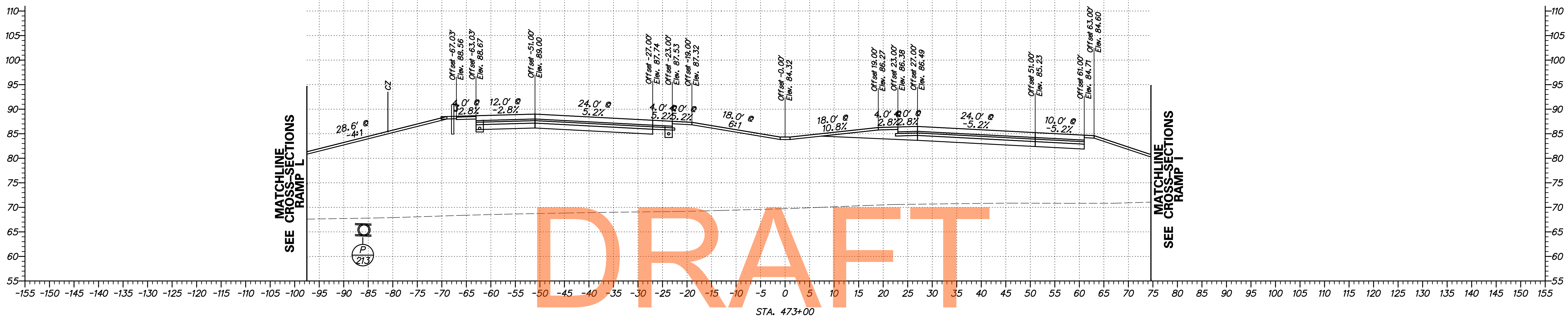

NOT FOR BIDDING

AUGUST 2015

G:\60049040 US301\CIVIL\PLANS\2A\XSEC\XS273.DGN

DELAWARE DEPARTMENT OF TRANSPORTATION	ADDENDUMS / REVISIONS	SCALE FEET	US 301 LEVELS ROAD TO SUMMIT BRIDGE ROAD	CONTRACT T20091303	BRIDGE NO.	CROSS SECTIONS US 301 MAINLINE STA. 472+50 - STA. 473+00	SHEET NO. 288
					COUNTY NEW CASTLE		DESIGNED BY: SS

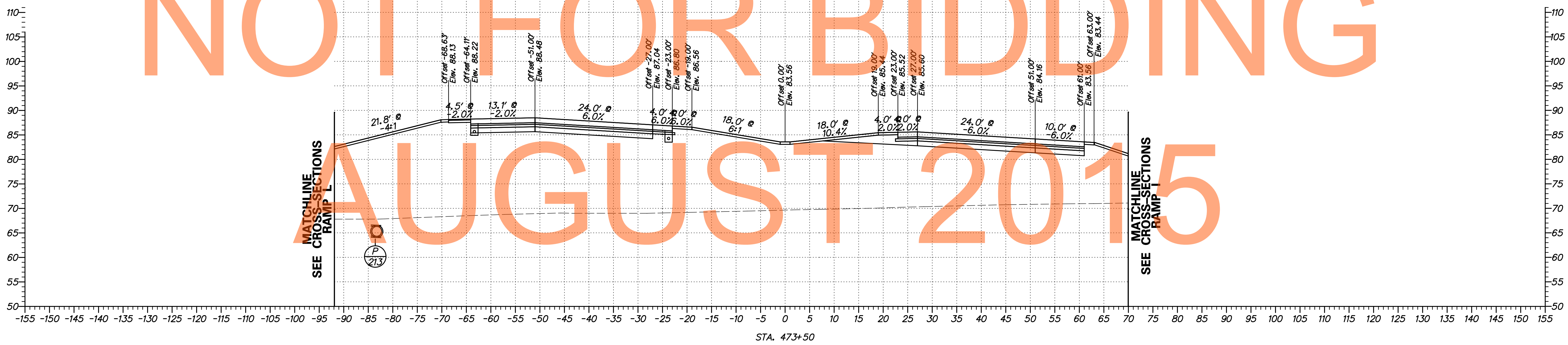
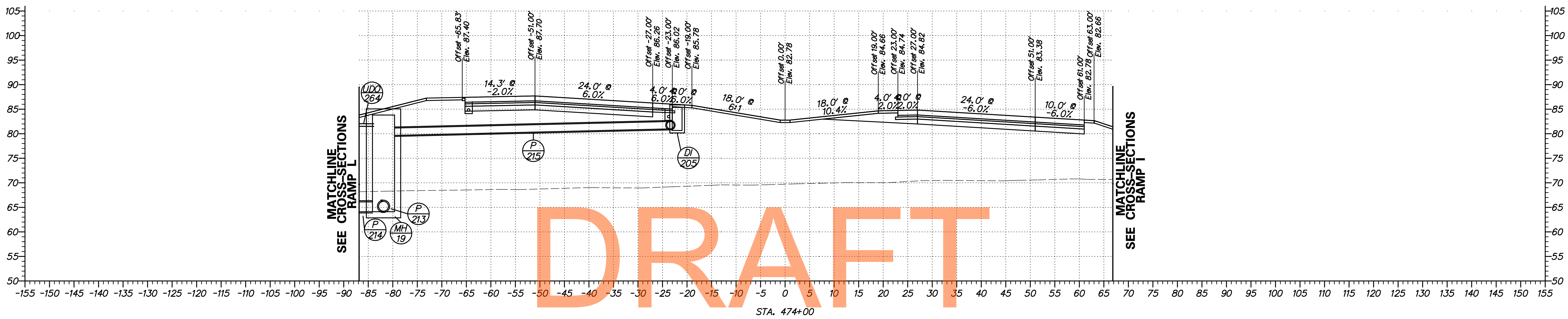

DRAFT

NOT FOR BIDDING

AUGUST 2015

G:\60049040 US301\CIVIL\PLANS\2A\XSEC\XS274.DGN

DELAWARE DEPARTMENT OF TRANSPORTATION	ADDENDUMS / REVISIONS	SCALE FEET	US 301 LEVELS ROAD TO SUMMIT BRIDGE ROAD	CONTRACT T200911303	BRIDGE NO.	CROSS SECTIONS US 301 MAINLINE STA. 473+50 - STA. 474+00	SHEET NO. 289
					COUNTY NEW CASTLE		DESIGNED BY: SS

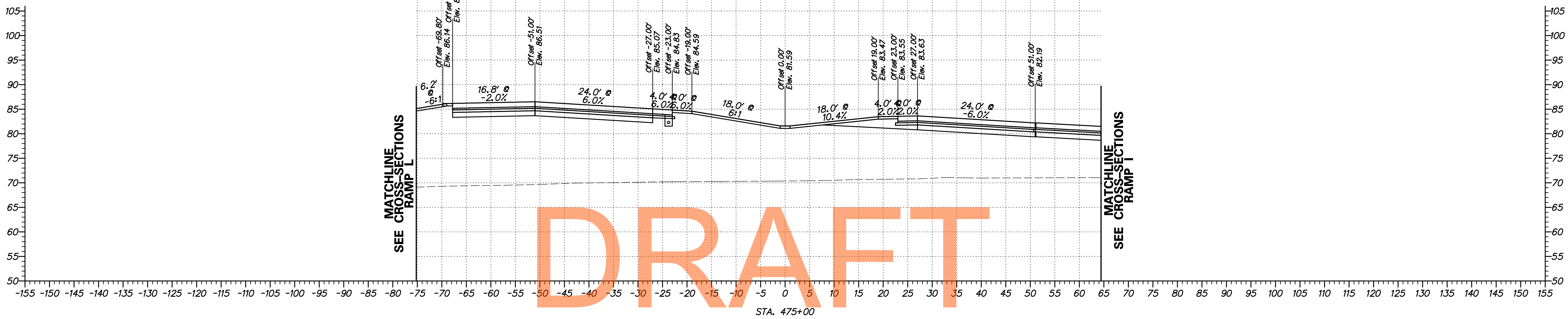

DRAFT

NOT FOR BIDDING

AUGUST 2015

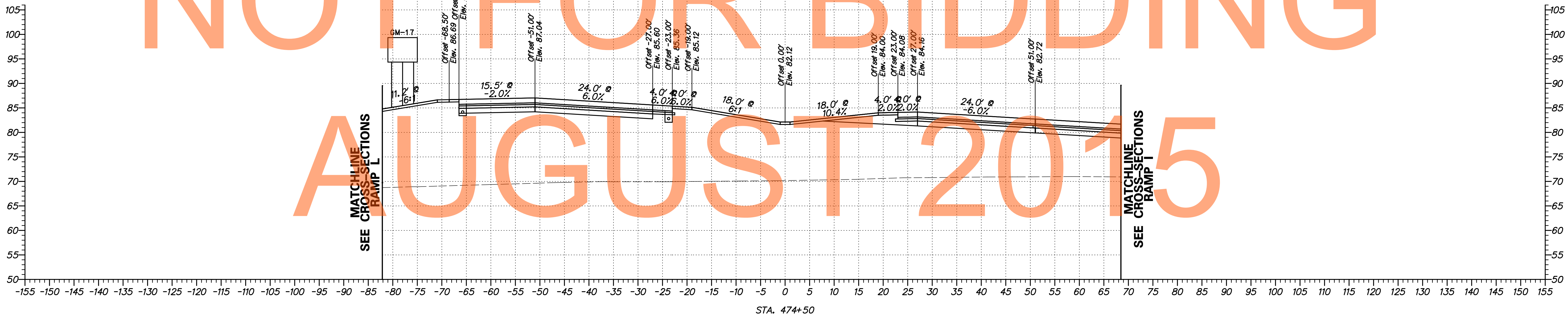

G:\60049040 US301\CIVIL\PLANS\2A\XSEC\XS275.DGN

DELAWARE DEPARTMENT OF TRANSPORTATION	ADDENDUMS / REVISIONS	SCALE FEET	US 301 LEVELS ROAD TO SUMMIT BRIDGE ROAD	CONTRACT T20091303	BRIDGE NO.	CROSS SECTIONS US 301 MAINLINE STA. 474+50 - STA. 475+00	SHEET NO. 290
					COUNTY NEW CASTLE		DESIGNED BY: SS

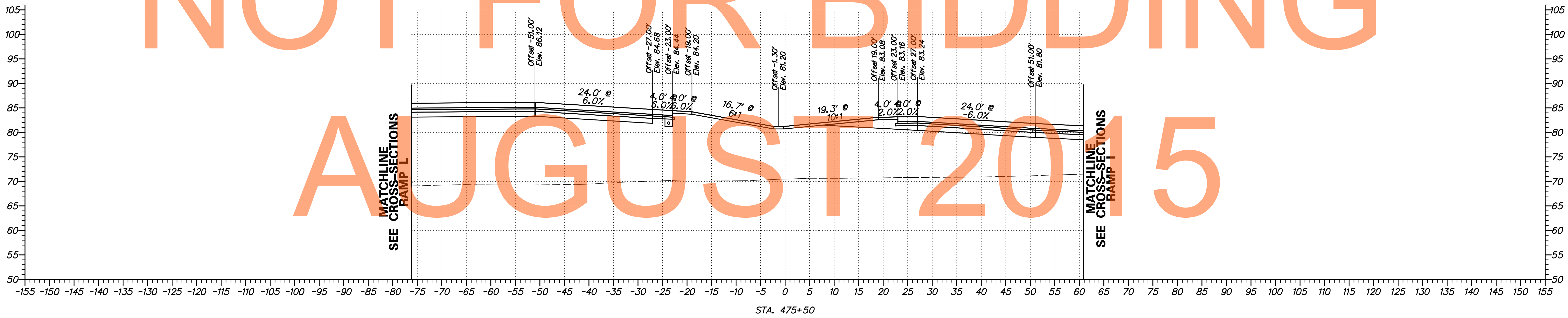
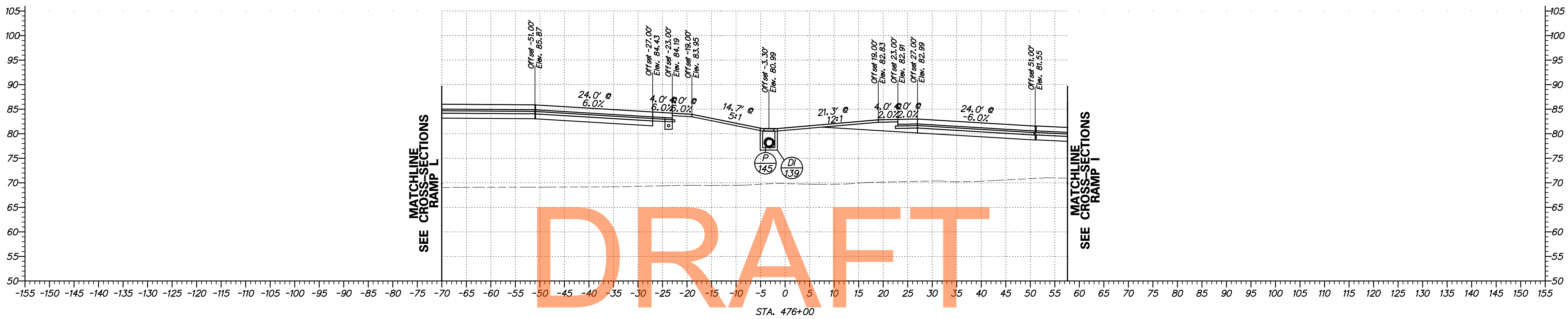

DRAFT

NOT FOR BIDDING

AUGUST 2015

G:\60049040 US30N\CIVIL\PLANS\2A\XSEC\XS276.DGN

DELAWARE DEPARTMENT OF TRANSPORTATION	ADDENDUMS / REVISIONS	SCALE FEET	US 301 LEVELS ROAD TO SUMMIT BRIDGE ROAD	CONTRACT T20091303	BRIDGE NO.	CROSS SECTIONS US 301 MAINLINE STA. 475+50 - STA. 476+00	SHEET NO. 291
					COUNTY NEW CASTLE		DESIGNED BY: SS

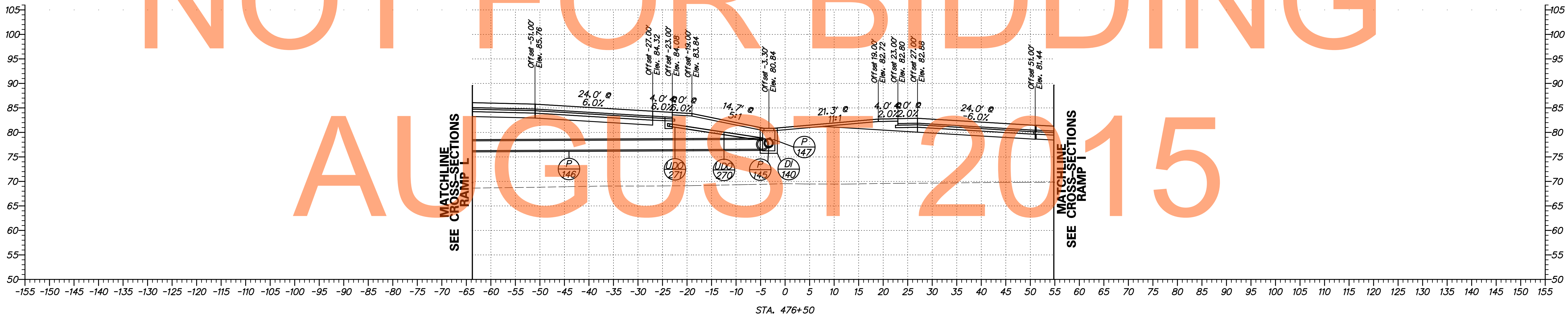
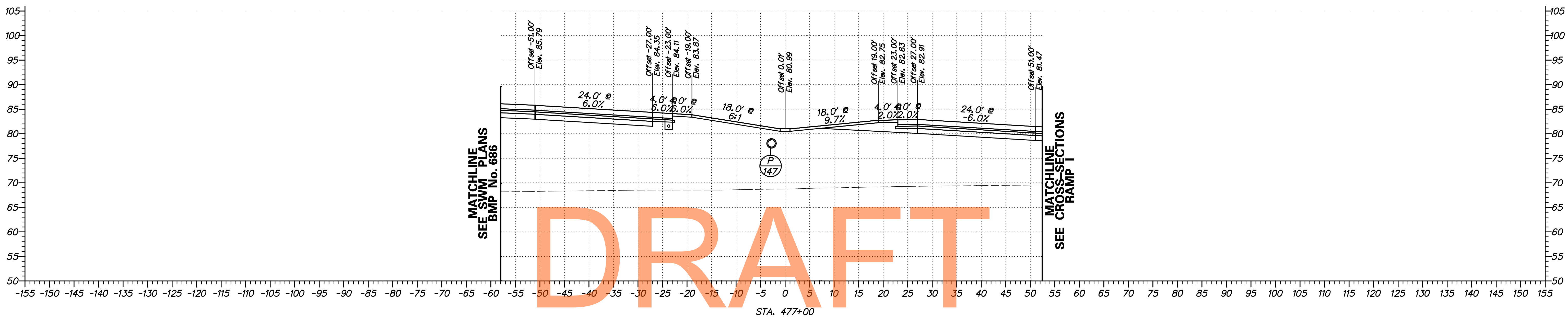

DRAFT

NOT FOR BIDDING

AUGUST 2015

G:\60049040 US301\CIVIL\PLANS\2A\XSEC\XS277.DGN

	DELAWARE DEPARTMENT OF TRANSPORTATION	ADDENDUMS / REVISIONS <table border="1" style="width: 100%; height: 20px;"> <tr><td> </td><td> </td></tr> </table>			SCALE 	US 301 LEVELS ROAD TO SUMMIT BRIDGE ROAD	CONTRACT T20091303	BRIDGE NO. DESIGNED BY: SS CHECKED BY: AM	CROSS SECTIONS US 301 MAINLINE STA. 476+50 - STA. 477+00	SHEET NO. 292 TOTAL SHTS. 518

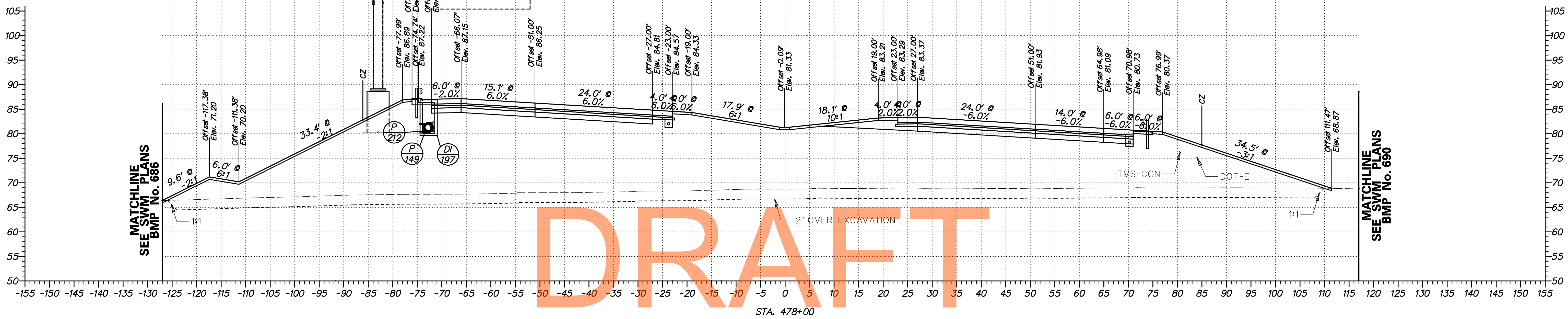

DRAFT

NOT FOR BIDDING

AUGUST 2015

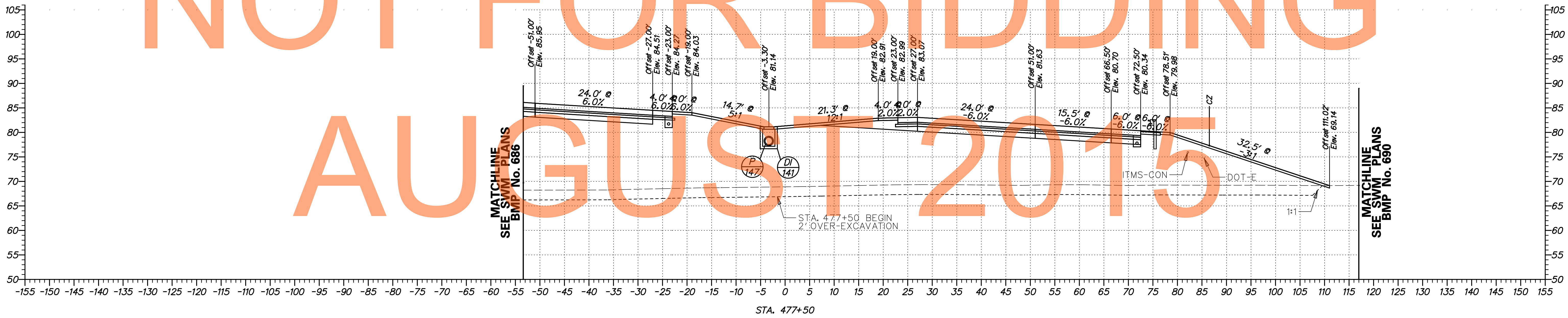

G:\60049040 US301\CIVIL\PLANS\2A\XSEC\XS278.DGN

	DELAWARE DEPARTMENT OF TRANSPORTATION	ADDENDUMS / REVISIONS	SCALE 0 10 20 30 FEET	US 301 LEVELS ROAD TO SUMMIT BRIDGE ROAD	CONTRACT T20091303	BRIDGE NO. DESIGNED BY: SS CHECKED BY: AM	CROSS SECTIONS US 301 MAINLINE STA. 477+50 - STA. 478+00	SHEET NO. 293 TOTAL SHTS. 518

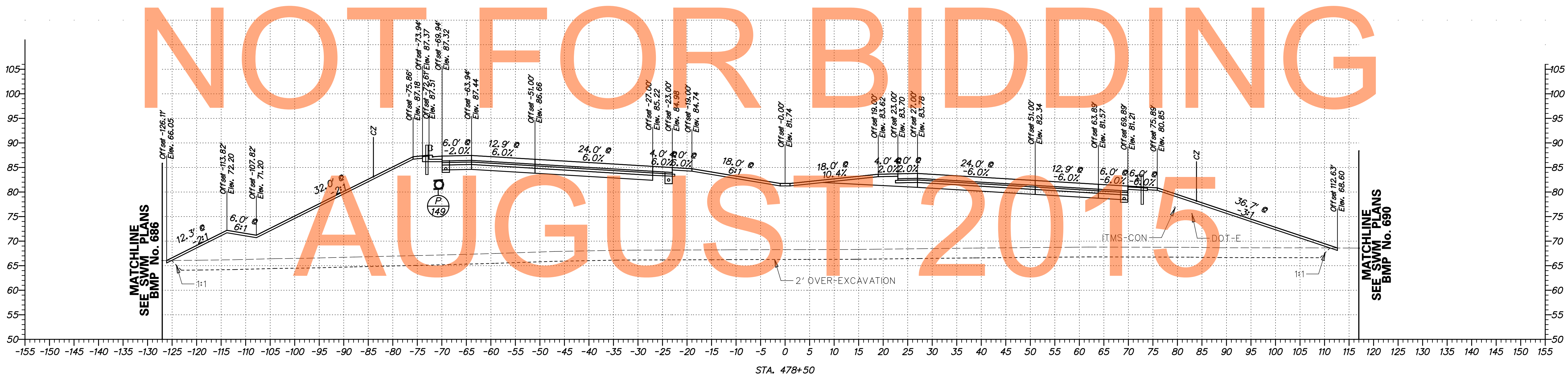
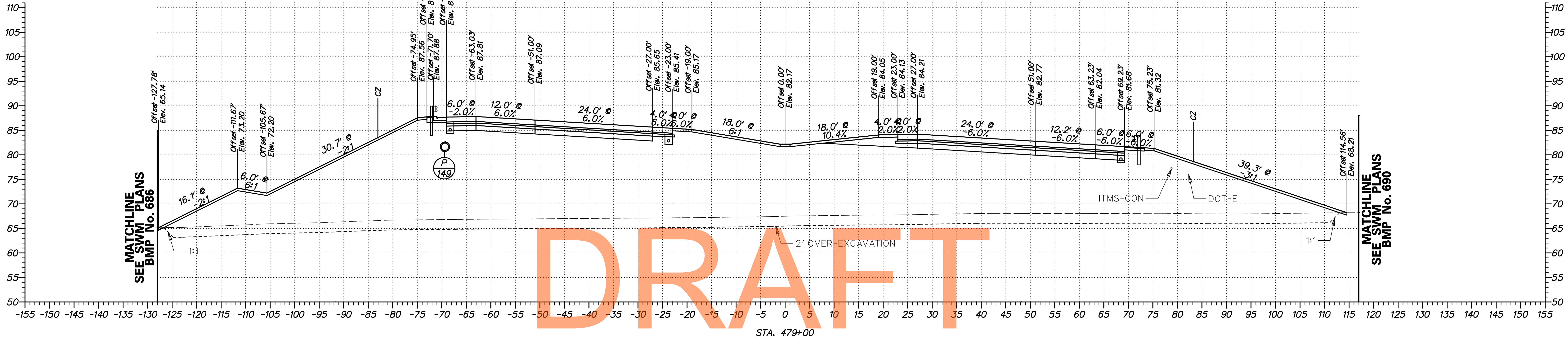

NOT FOR BIDDING
AUGUST 2015

G:\60049040 US301\CIVIL\PLANS\2A\XSEC\XS279.DGN

ADDENDUMS / REVISIONS	

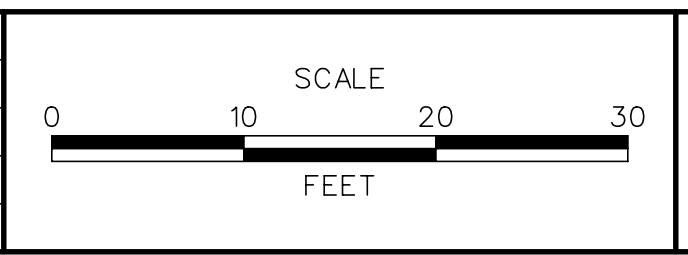

CONTRACT	BRIDGE NO.
T20091303	DESIGNED BY: SS
COUNTY	CHECKED BY: AM
NEW CASTLE	

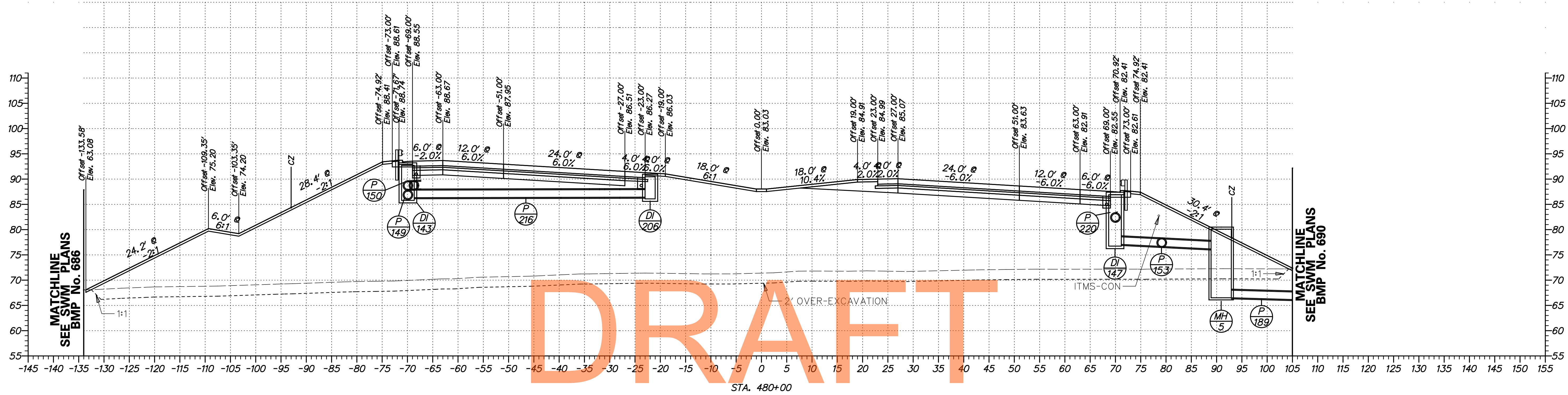

DRAFT

NOT FOR BIDDING

AUGUST 2015

G:\60049040 US301\CIVIL\PLANS\2A\YSEC\XS280.DGN

DELAWARE DEPARTMENT OF TRANSPORTATION	ADDENDUMS / REVISIONS	SCALE FEET	US 301 LEVELS ROAD TO SUMMIT BRIDGE ROAD	CONTRACT	BRIDGE NO.	CROSS SECTIONS US 301 MAINLINE STA. 480 + 00	SHEET NO.
					T20091303		
				COUNTY	CHECKED BY: AM	TOTAL SHTS.	518
				NEW CASTLE			

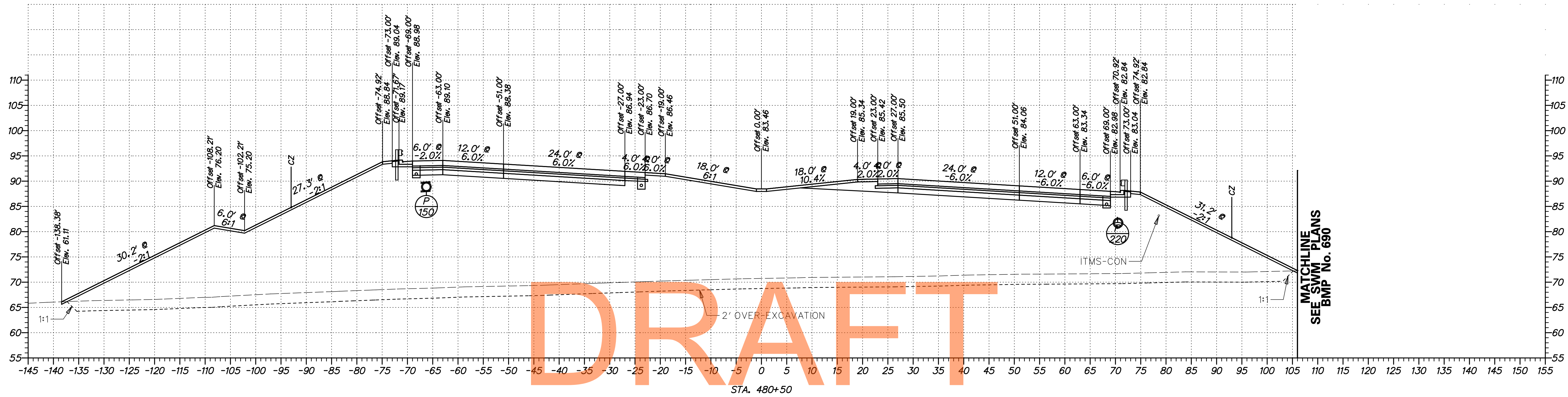

DRAFT

NOT FOR BIDDING

AUGUST 2015

G:\60049040 US301\CIVIL\PLANS\2A\YSEC\XS281.DGN

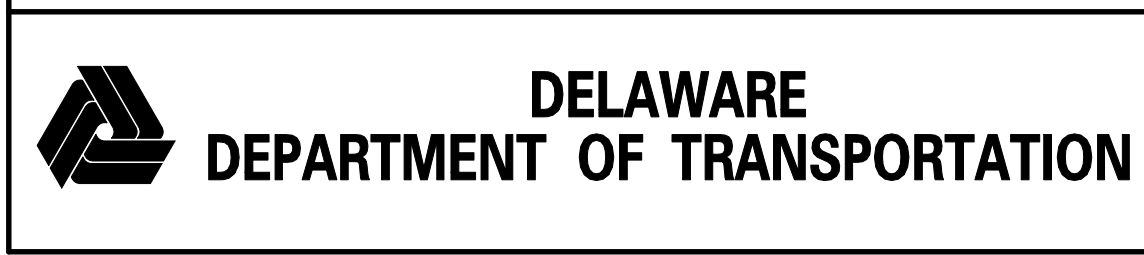

ADDENDUMS / REVISIONS	

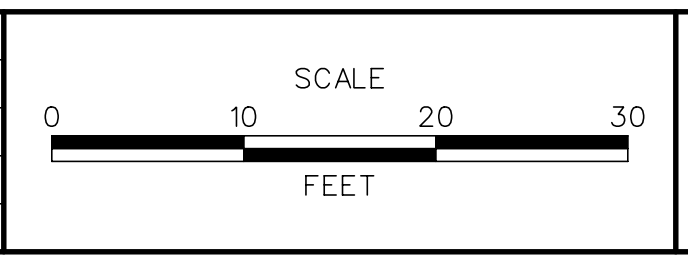

US 301
LEVELS ROAD
TO SUMMIT BRIDGE ROAD

CONTRACT	BRIDGE NO.	
T20091303	DESIGNED BY:	SS
COUNTY	CHECKED BY:	AM
NEW CASTLE		

CROSS SECTIONS
US 301 MAINLINE
STA. 480 + 50

SHEET NO.	296
TOTAL SHTS.	518

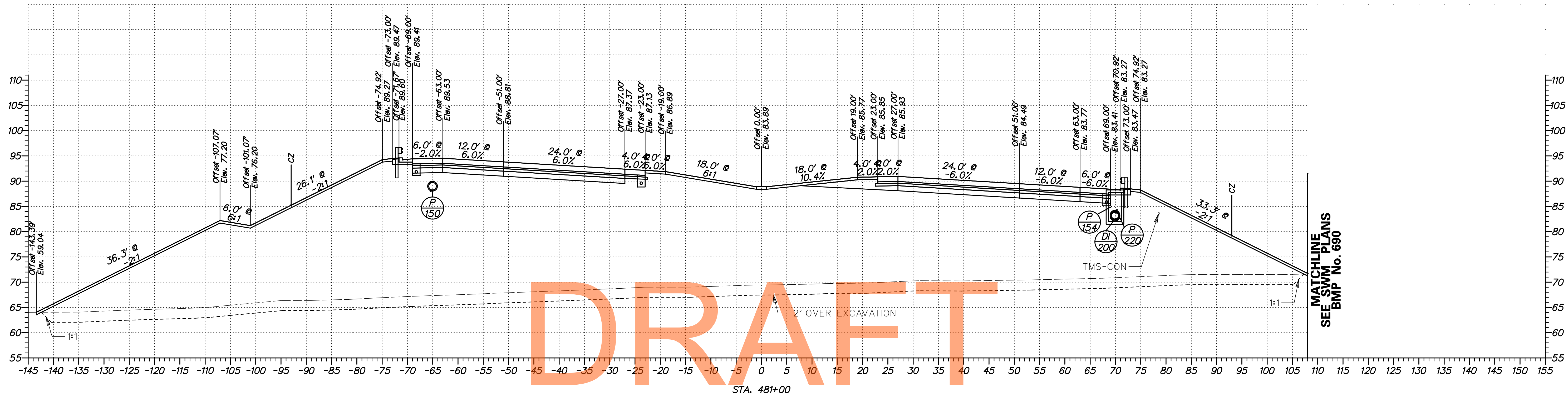

NOT FOR BIDDING

AUGUST 2015

G:\60049040 US301\CIVIL\PLANS\2A\XSEC\XS282.DGN

<p>DELAWARE DEPARTMENT OF TRANSPORTATION</p>	ADDENDUMS / REVISIONS	<p>SCALE</p> <p>0 10 20 30</p> <p>FEET</p>	<p>US 301 LEVELS ROAD TO SUMMIT BRIDGE ROAD</p>	CONTRACT	BRIDGE NO.	<p>CROSS SECTIONS US 301 MAINLINE STA. 481 + 00</p>	SHEET NO.
					T20091303		DESIGNED BY: SS
				COUNTY	CHECKED BY: AM	TOTAL SHTS.	518
				NEW CASTLE			

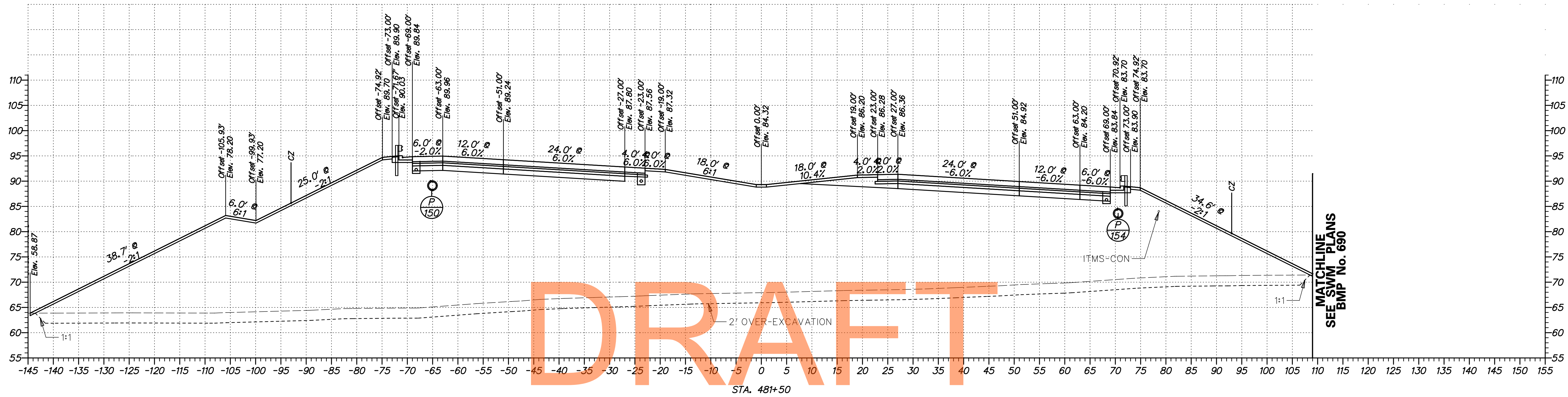

DRAFT

NOT FOR BIDDING

AUGUST 2015

G:\60049040 US301\CIVIL\PLANS\2A\YSEC\XS283.DGN

	ADDENDUMS / REVISIONS		SCALE 0 10 20 30 FEET	US 301 LEVELS ROAD TO SUMMIT BRIDGE ROAD	CONTRACT	BRIDGE NO.	CROSS SECTIONS US 301 MAINLINE STA. 481 + 50	SHEET NO.
					T20091303	DESIGNED BY: SS		298
					COUNTY	CHECKED BY: AM	TOTAL SHTS.	518
					NEW CASTLE			

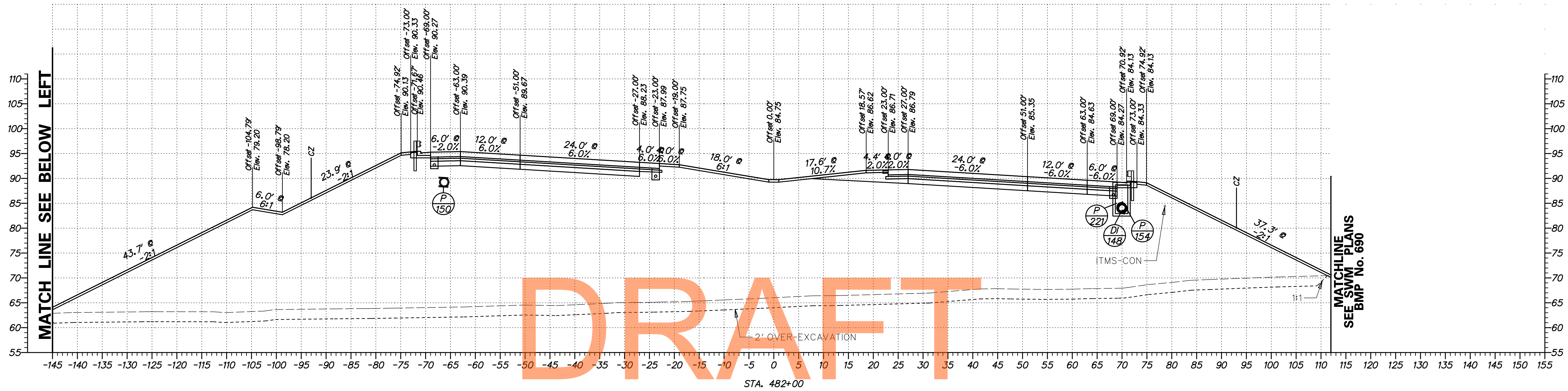

DRAFT

NOT FOR BIDDING

AUGUST 2015

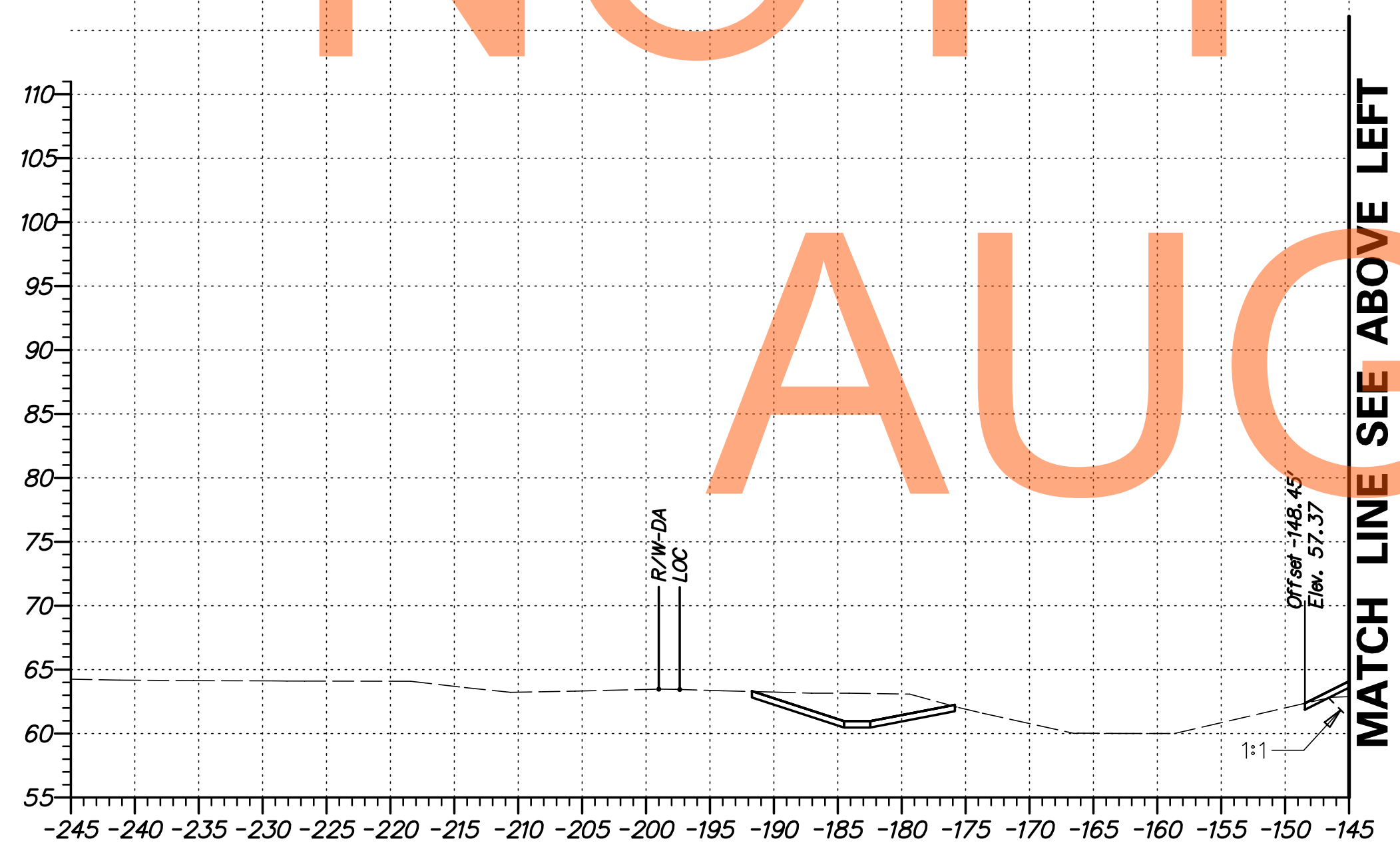

G:\60049040 US301\CIVIL\PLANS\2A\XSEC\XS284.DGN

<p>DELAWARE DEPARTMENT OF TRANSPORTATION</p>	ADDENDUMS / REVISIONS	<p>SCALE</p>	<p>US 301 LEVELS ROAD TO SUMMIT BRIDGE ROAD</p>	CONTRACT	BRIDGE NO.	<p>CROSS SECTIONS US 301 MAINLINE STA. 482+00</p>	SHEET NO.
					T20091303		
				COUNTY	CHECKED BY: AM		TOTAL SHTS.
				NEW CASTLE			518

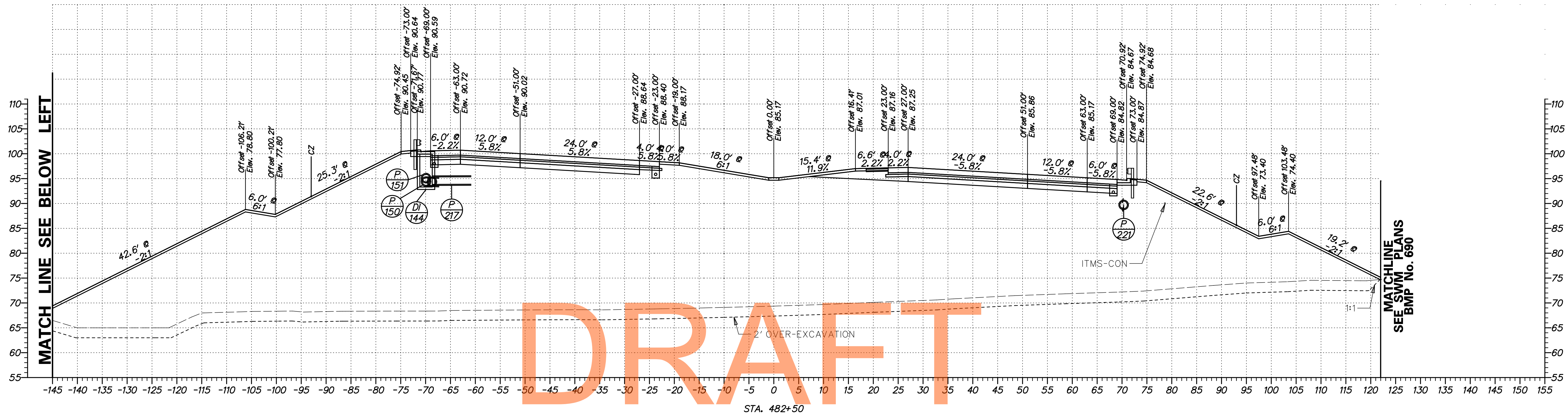

DRAFT

NOT FOR BIDDING

AUGUST 2015

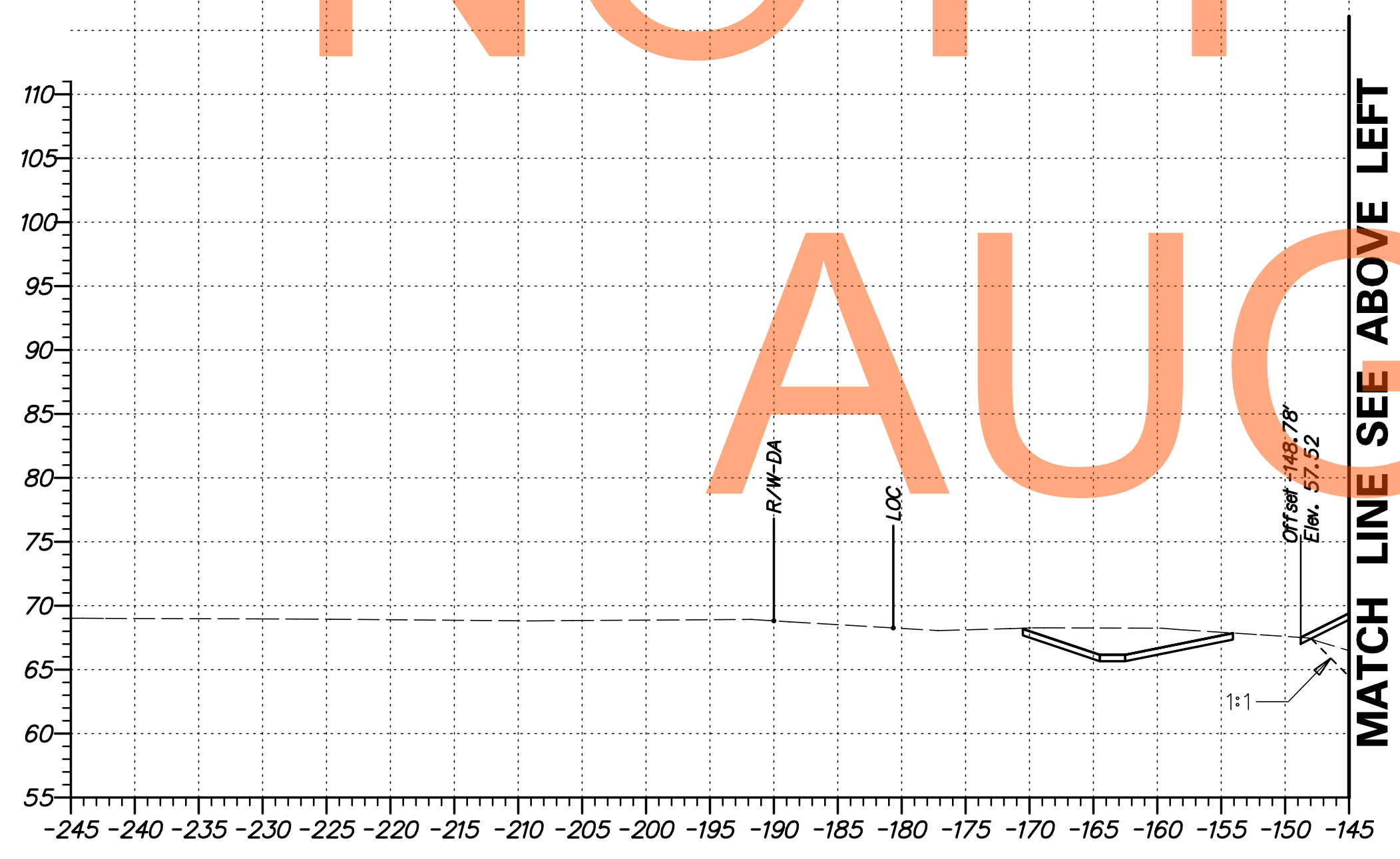

G:\60049040 US301\CIVIL\PLANS\2A\XSEC\XS285.DGN

DELAWARE DEPARTMENT OF TRANSPORTATION	ADDENDUMS / REVISIONS	SCALE 	US 301 LEVELS ROAD TO SUMMIT BRIDGE ROAD	CONTRACT T20091303	BRIDGE NO.	CROSS SECTIONS US 301 MAINLINE STA. 482 + 50	SHEET NO. 300
					COUNTY NEW CASTLE		DESIGNED BY: SS

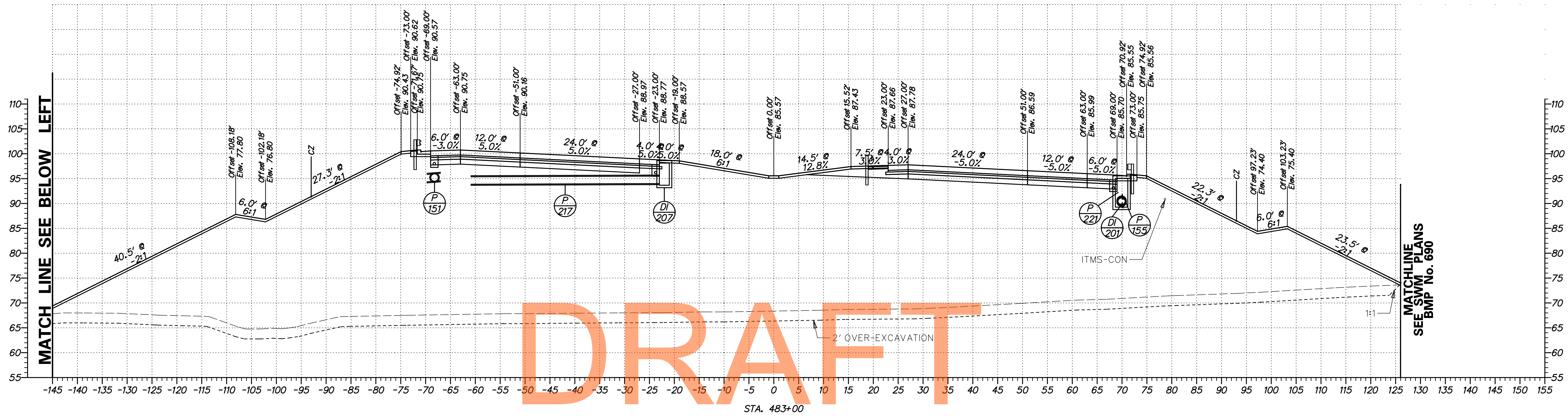

DRAFT

NOT FOR BIDDING

AUGUST 2015

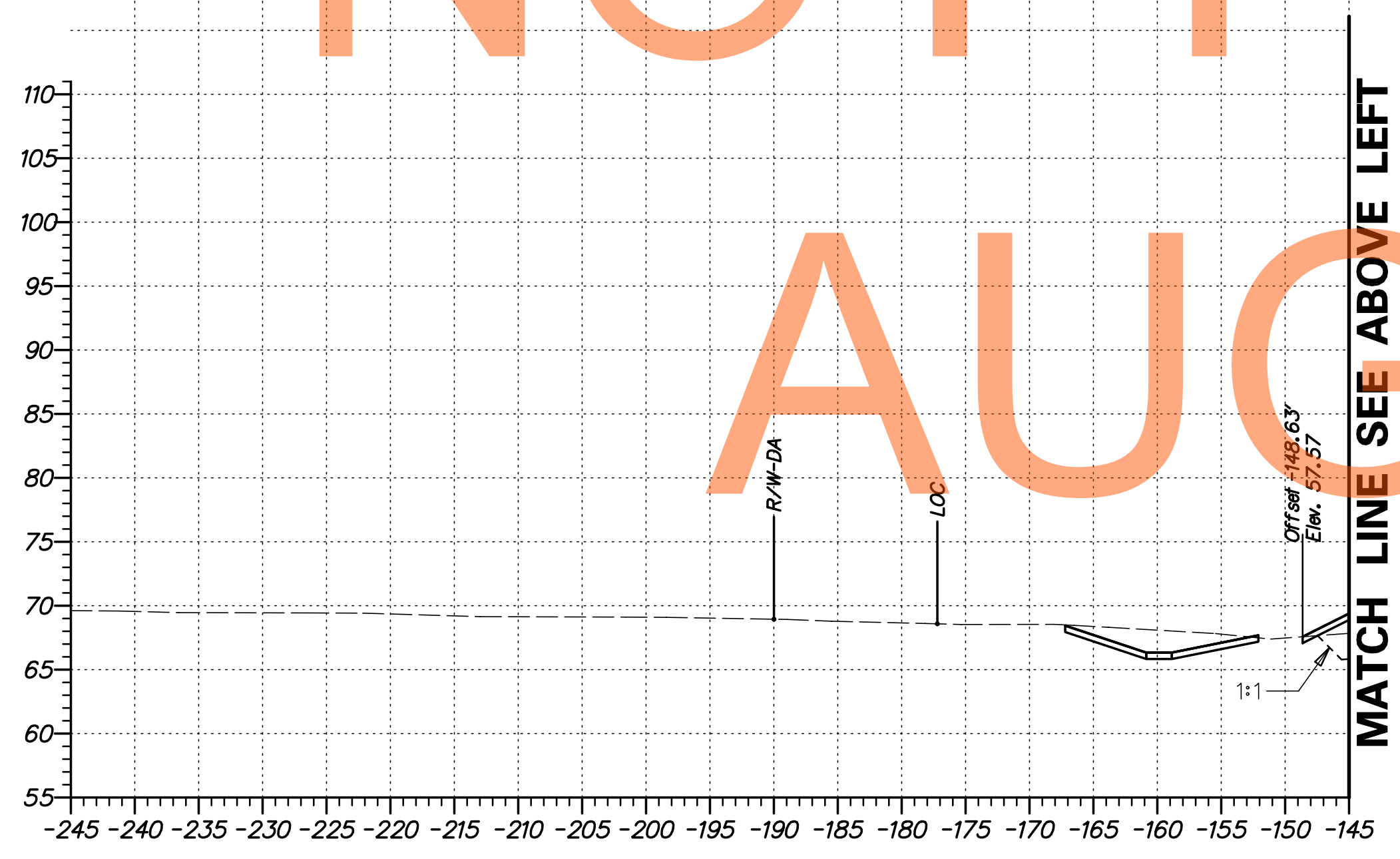

G:\60049040 US301\CIVIL\PLANS\2A\XSEC\XS286.DGN

	ADDENDUMS / REVISIONS		SCALE 0 10 20 30 FEET	US 301 LEVELS ROAD TO SUMMIT BRIDGE ROAD	CONTRACT	BRIDGE NO.	CROSS SECTIONS US 301 MAINLINE STA. 483+00	SHEET NO.
					T20091303			DESIGNED BY: SS
					COUNTY	CHECKED BY: AM	TOTAL SHTS.	
					NEW CASTLE		518	

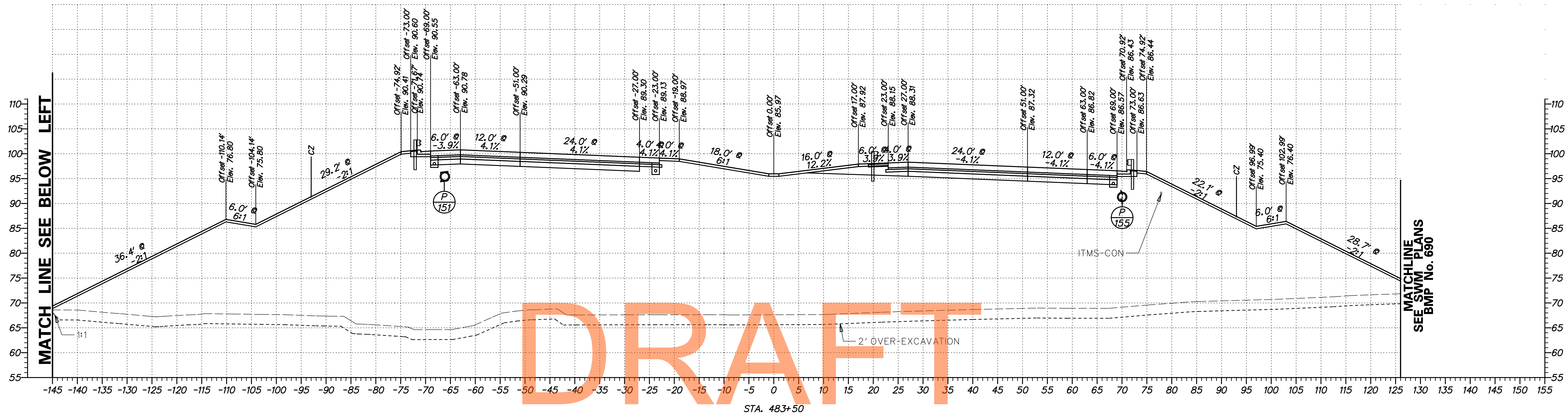

DRAFT

NOT FOR BIDDING

AUGUST 2015

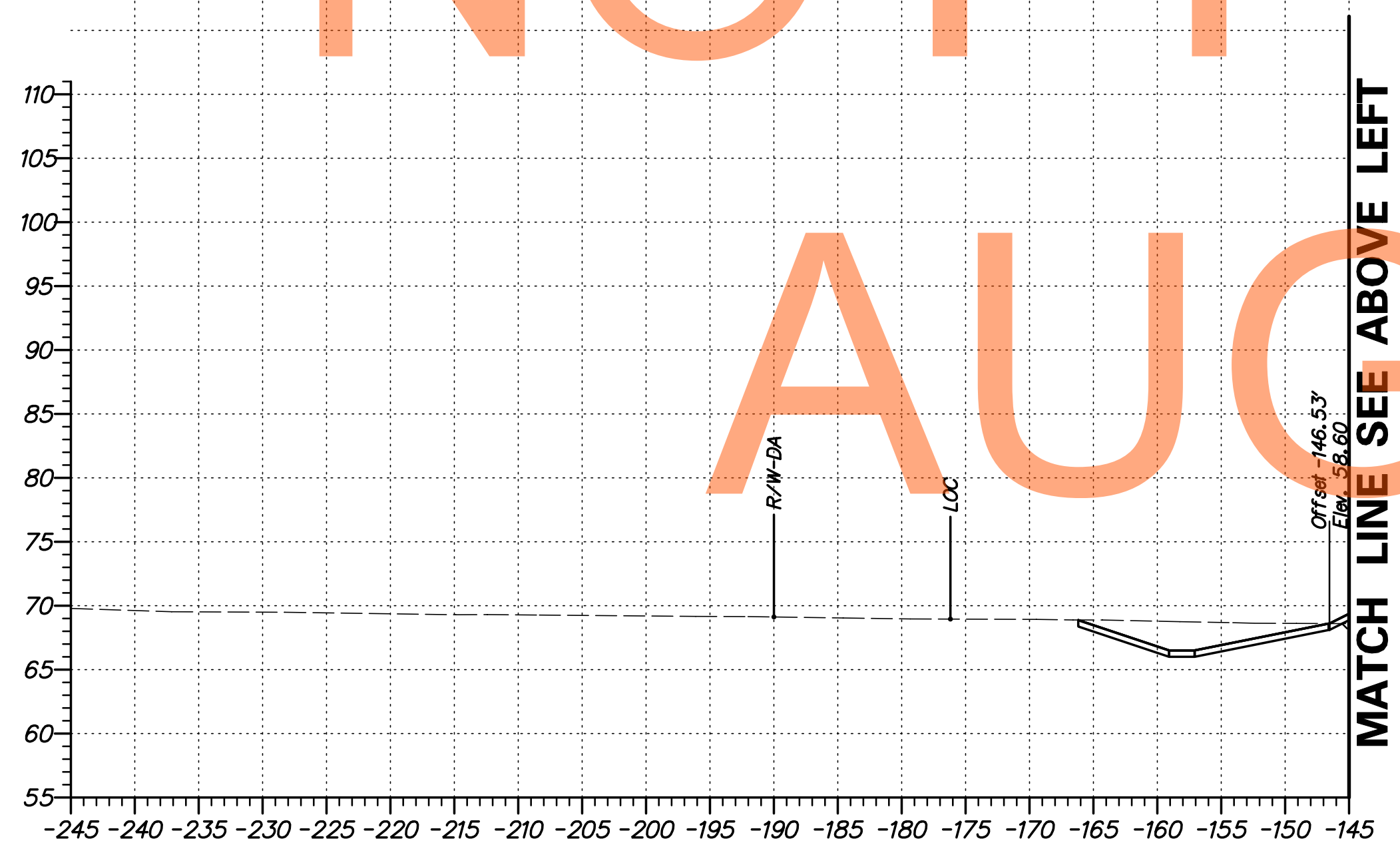

G:\60049040 US301\CIVIL\PLANS\2A\XSEC\XS287.DGN

	DELAWARE DEPARTMENT OF TRANSPORTATION	ADDENDUMS / REVISIONS	SCALE 	US 301 LEVELS ROAD TO SUMMIT BRIDGE ROAD	CONTRACT T20091303	BRIDGE NO.	CROSS SECTIONS US 301 MAINLINE STA. 483 + 50	SHEET NO. 302
		COUNTY NEW CASTLE			DESIGNED BY: SS	CHECKED BY: AM		TOTAL SHTS. 518

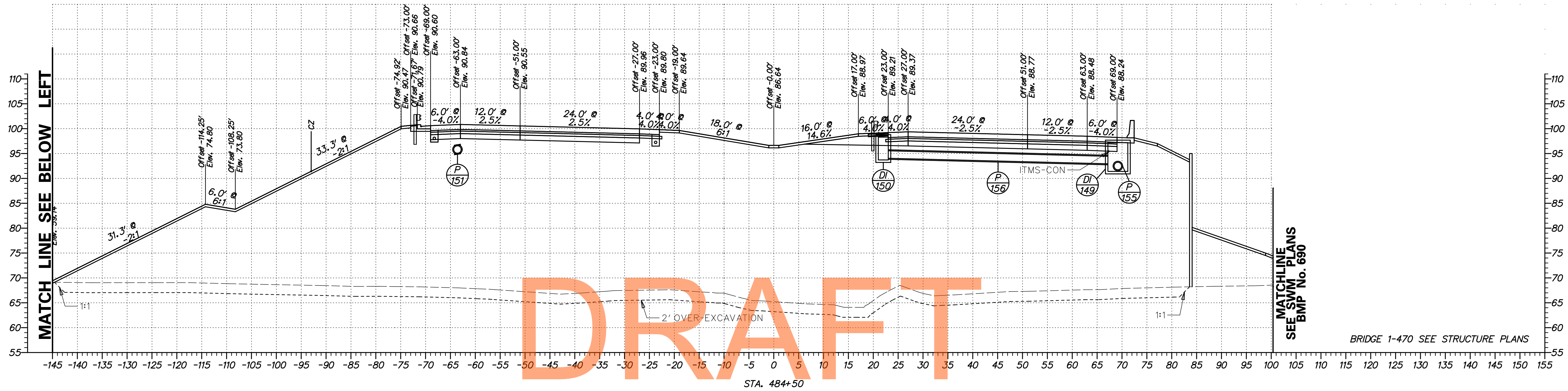

DRAFT

NOT FOR BIDDING

AUGUST 2015

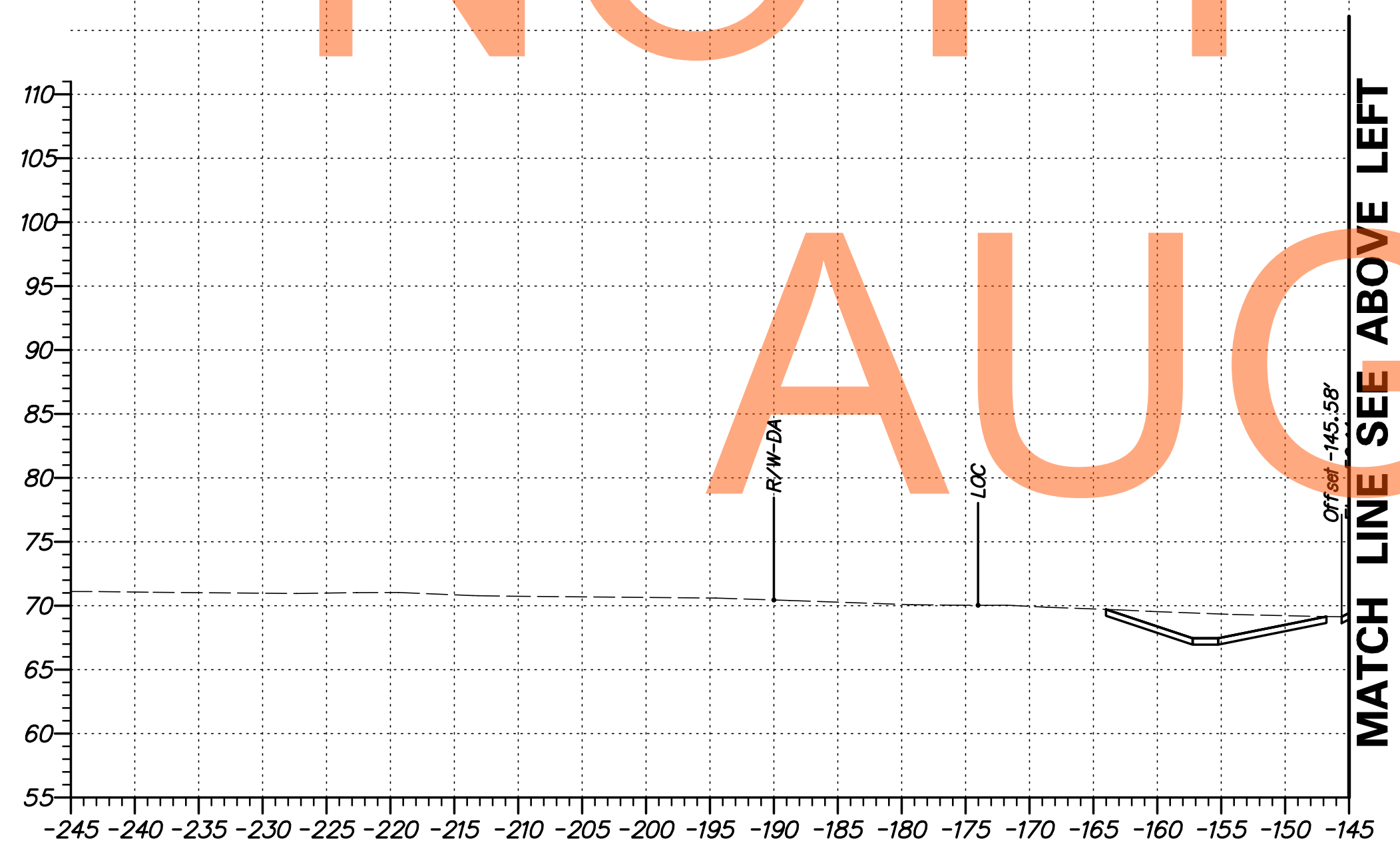

G:\60049040 US301\CIVIL\PLANS\2A\XSEC\XS289.DGN

<p>DELAWARE DEPARTMENT OF TRANSPORTATION</p>	ADDENDUMS / REVISIONS	<p>SCALE</p>	<p>US 301 LEVELS ROAD TO SUMMIT BRIDGE ROAD</p>		<p>CONTRACT</p> <p>T20091303</p>	<p>BRIDGE NO.</p>	<p>CROSS SECTIONS US 301 MAINLINE STA. 484 + 50</p>	<p>SHEET NO.</p> <p>304</p>
				<p>COUNTY</p> <p>NEW CASTLE</p>	<p>DESIGNED BY: SS</p> <p>CHECKED BY: AM</p>	<p>TOTAL SHTS.</p> <p>518</p>		

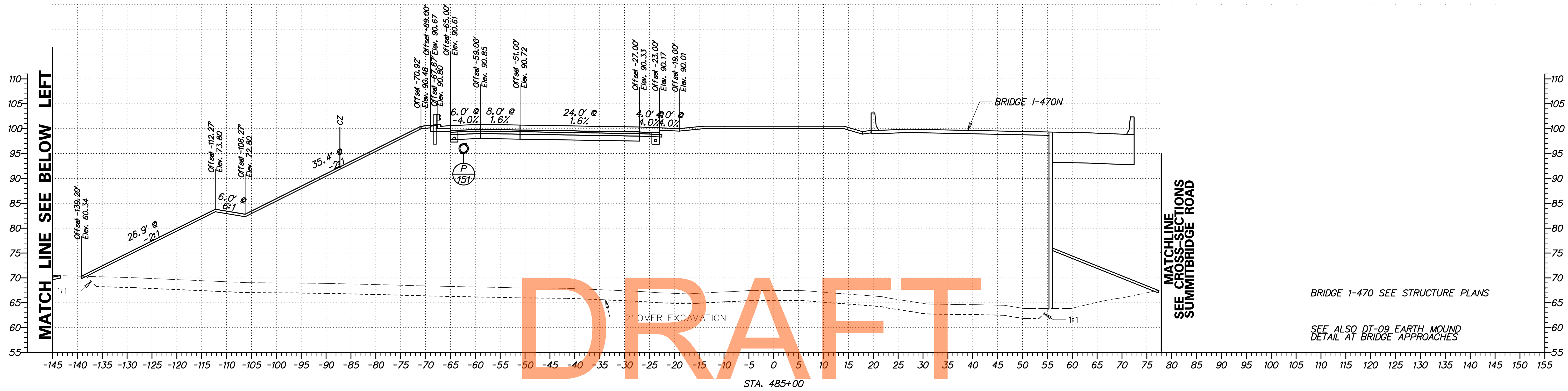

DRAFT

NOT FOR BIDDING

AUGUST 2015

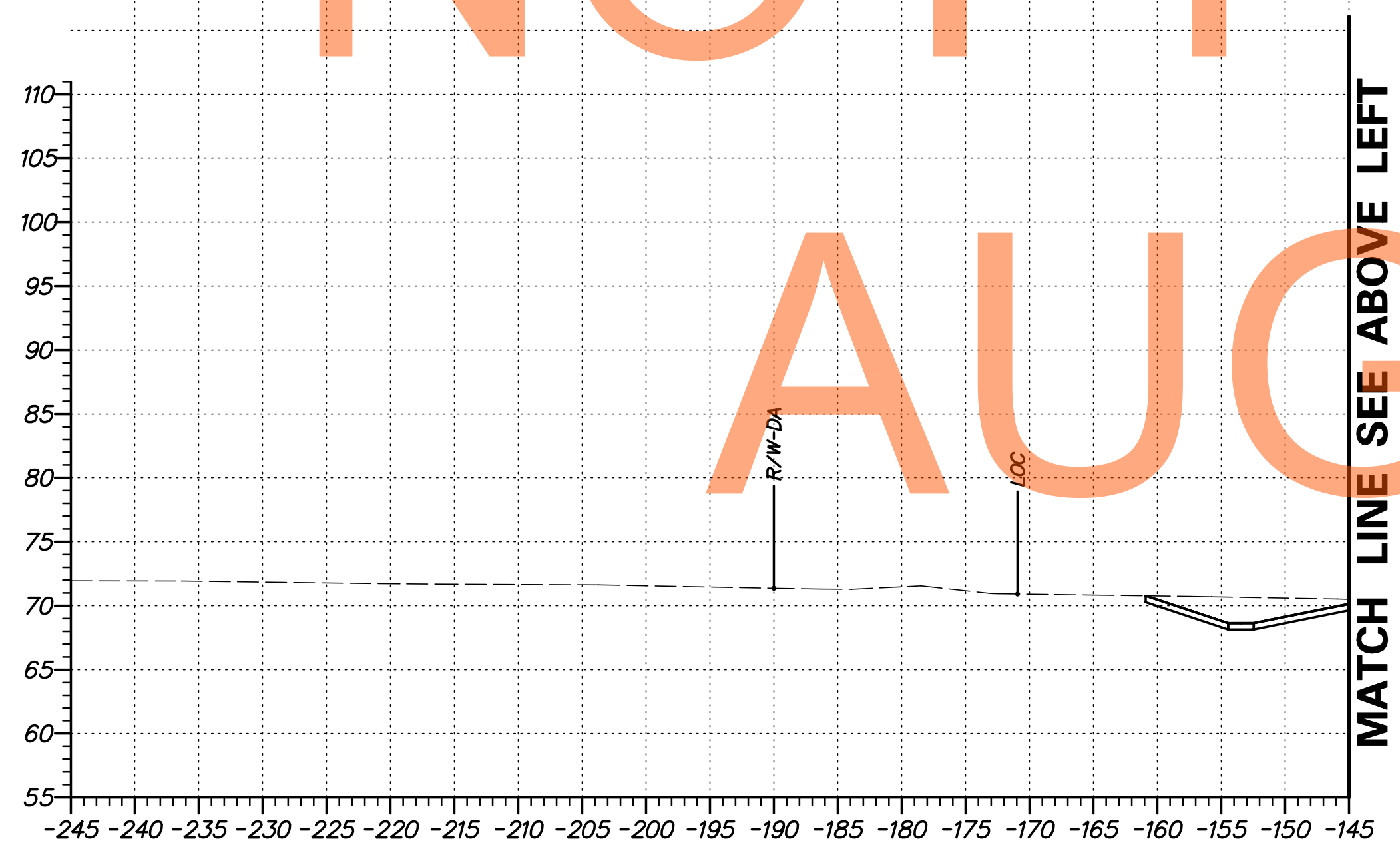

G:\60049040 US301\CIVIL\PLANS\2A\XSEC\XS290.DGN

DELAWARE DEPARTMENT OF TRANSPORTATION	ADDENDUMS / REVISIONS	SCALE FEET	US 301 LEVELS ROAD TO SUMMIT BRIDGE ROAD	CONTRACT T20091303	BRIDGE NO.	CROSS SECTIONS US 301 MAINLINE STA. 485 + 00	SHEET NO. 305
					COUNTY NEW CASTLE		DESIGNED BY: SS CHECKED BY: AM

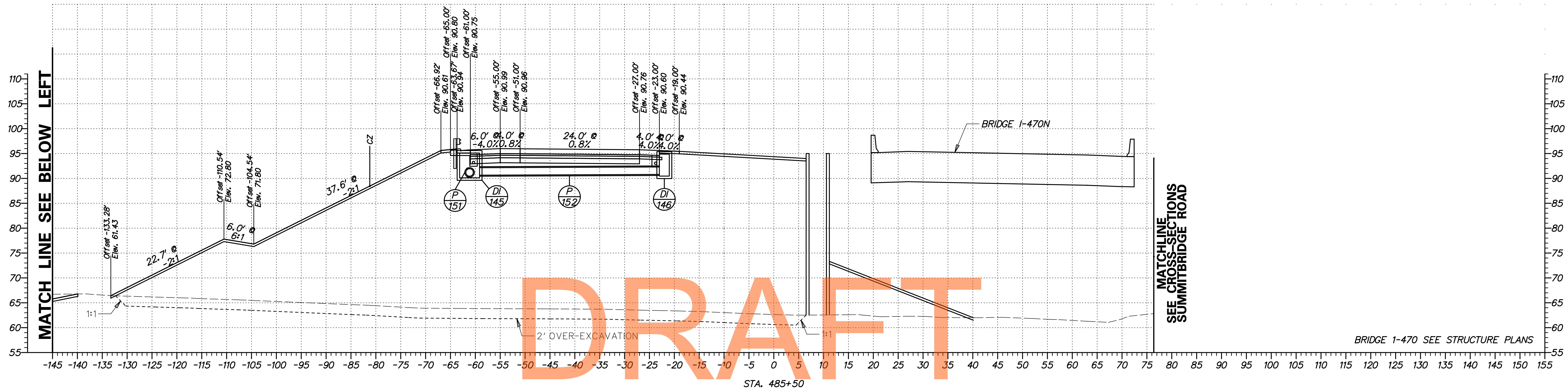

NOT FOR BIDDING
AUGUST 2015

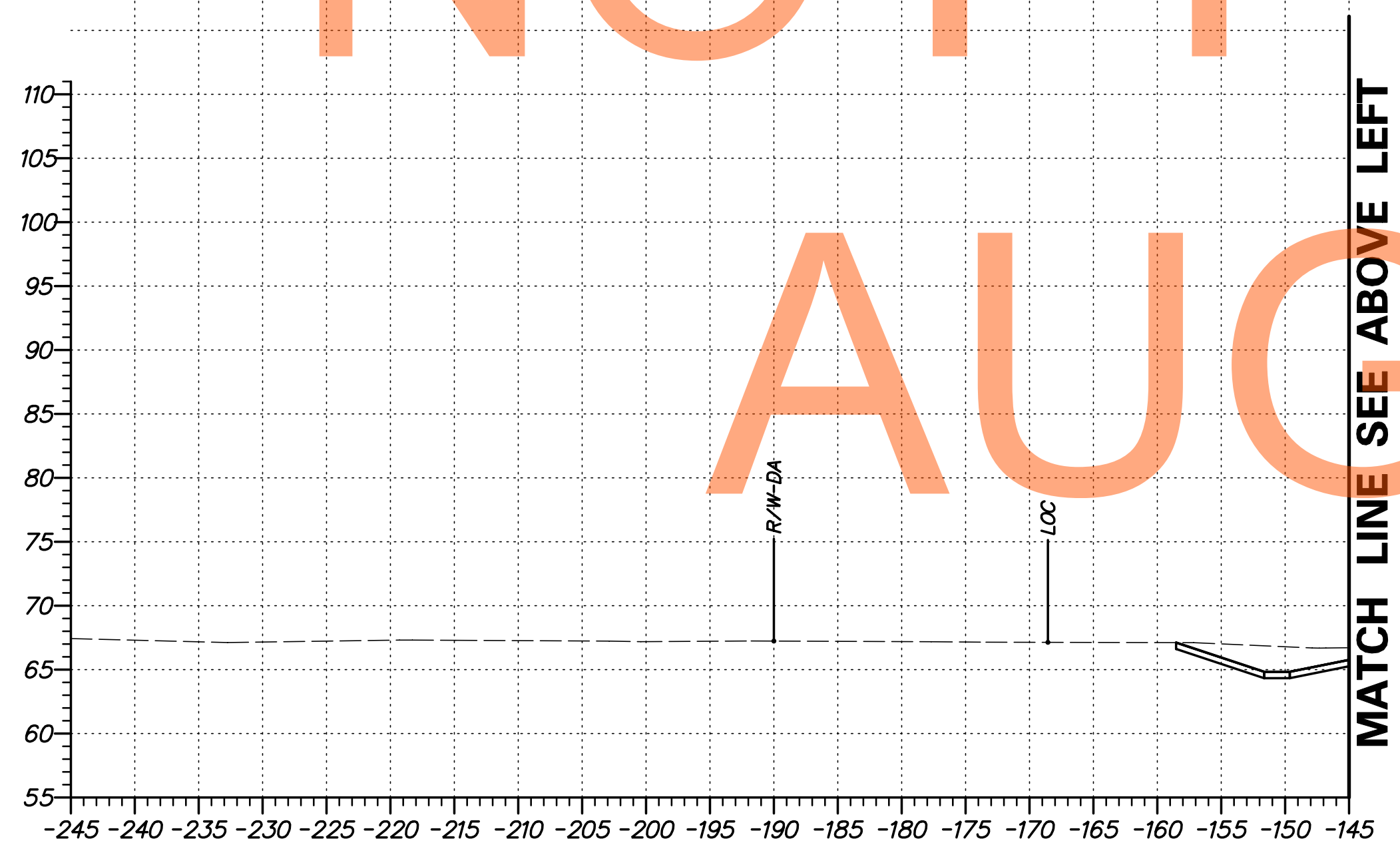

G:\60049040 US301\CIVIL\PLANS\2A\XSEC\XS291.DGN

DELAWARE DEPARTMENT OF TRANSPORTATION	ADDENDUMS / REVISIONS	SCALE FEET	US 301 LEVELS ROAD TO SUMMIT BRIDGE ROAD	CONTRACT T20091303	BRIDGE NO.	CROSS SECTIONS US 301 MAINLINE STA. 485 + 50	SHEET NO. 306
					COUNTY NEW CASTLE		DESIGNED BY: SS
				CHECKED BY: AM			

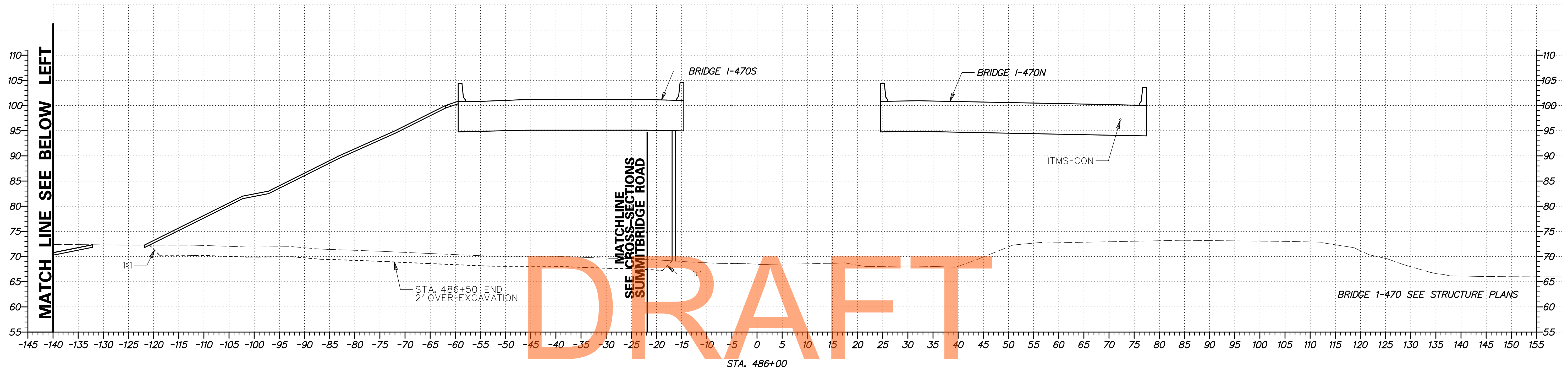

DRAFT

NOT FOR BIDDING

AUGUST 2015

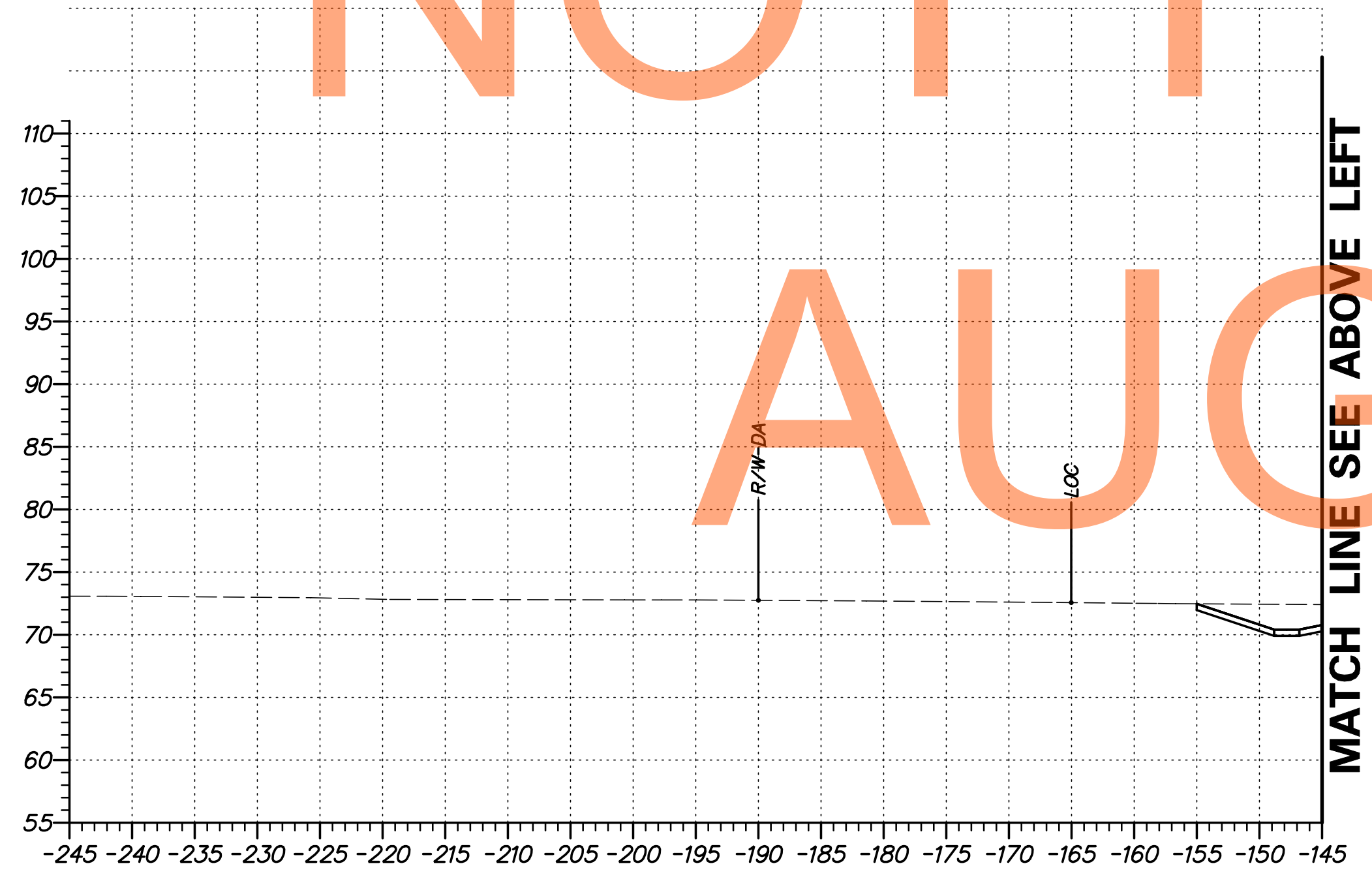

G:\60049040 US301\CIVIL\PLANS\2A\XSEC\XS292.DGN

DELAWARE DEPARTMENT OF TRANSPORTATION	ADDENDUMS / REVISIONS	<p>SCALE</p> <p>FEET</p>	US 301 LEVELS ROAD TO SUMMIT BRIDGE ROAD	<table border="1" style="width: 100%; border-collapse: collapse;"> <tr> <td style="font-size: 6px;">CONTRACT</td> <td style="font-size: 6px;">BRIDGE NO.</td> </tr> <tr> <td style="font-size: 6px;">T20091303</td> <td style="font-size: 6px;">DESIGNED BY: SS</td> </tr> <tr> <td style="font-size: 6px;">COUNTY</td> <td style="font-size: 6px;">CHECKED BY: AM</td> </tr> <tr> <td style="font-size: 6px;">NEW CASTLE</td> <td></td> </tr> </table>	CONTRACT	BRIDGE NO.	T20091303	DESIGNED BY: SS	COUNTY	CHECKED BY: AM	NEW CASTLE		CROSS SECTIONS US 301 MAINLINE STA. 486 + 00	<table border="1" style="width: 100%; border-collapse: collapse;"> <tr> <td style="font-size: 6px;">SHEET NO.</td> </tr> <tr> <td style="font-size: 6px;">307</td> </tr> <tr> <td style="font-size: 6px;">TOTAL SHTS.</td> </tr> <tr> <td style="font-size: 6px;">518</td> </tr> </table>	SHEET NO.	307	TOTAL SHTS.	518
	CONTRACT		BRIDGE NO.															
T20091303	DESIGNED BY: SS																	
COUNTY	CHECKED BY: AM																	
NEW CASTLE																		
SHEET NO.																		
307																		
TOTAL SHTS.																		
518																		

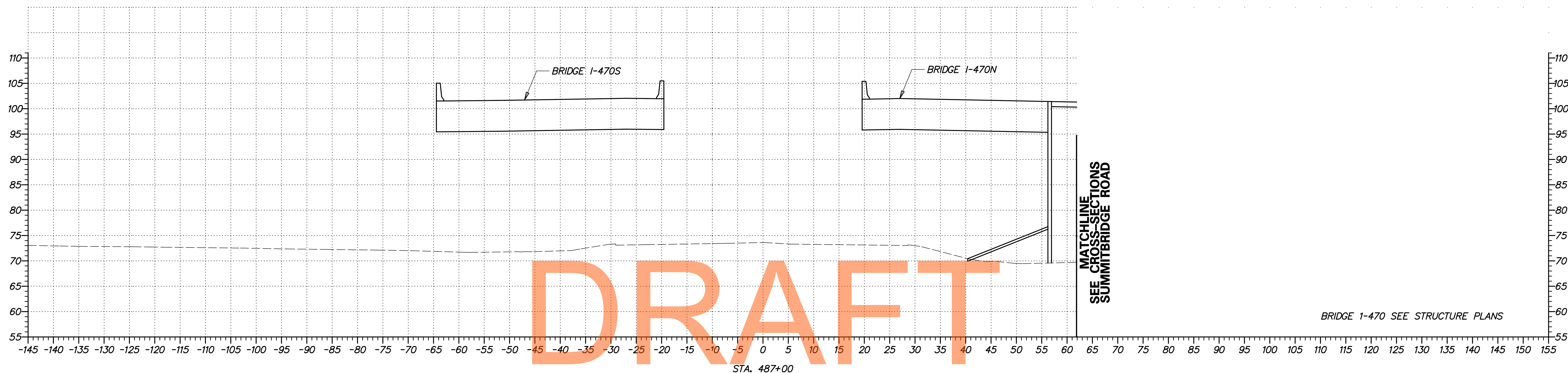

DRAFT

NOT FOR BIDDING

AUGUST 2015

G:\60049040 US301\CIVIL\PLANS\2A\XSEC\X5294.DGN

DELAWARE DEPARTMENT OF TRANSPORTATION	ADDENDUMS / REVISIONS	SCALE FEET	US 301 LEVELS ROAD TO SUMMIT BRIDGE ROAD	CONTRACT	BRIDGE NO.	CROSS SECTIONS US 301 MAINLINE STA. 487 + 00	SHEET NO.
					T20091303		
				COUNTY	DESIGNED BY: SS	TOTAL SHTS.	
				NEW CASTLE	CHECKED BY: AM	518	

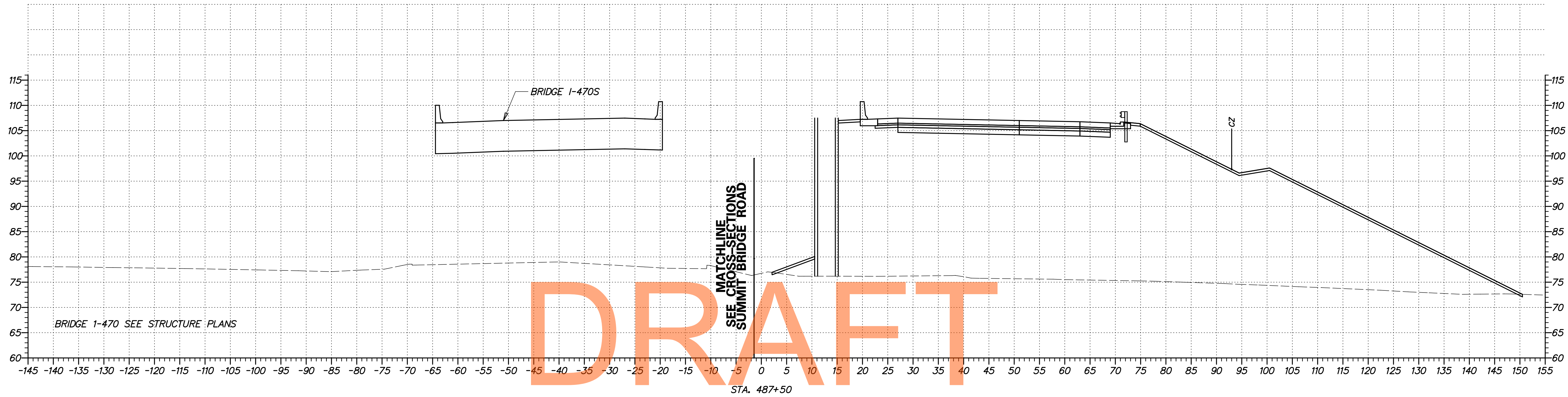

DRAFT

NOT FOR BIDDING

AUGUST 2015

G:\60049040 US301\CIVIL\PLANS\2A\XSEC\XS295.DGN

DELAWARE DEPARTMENT OF TRANSPORTATION	ADDENDUMS / REVISIONS	SCALE FEET	US 301 LEVELS ROAD TO SUMMIT BRIDGE ROAD	CONTRACT	BRIDGE NO.	CROSS SECTIONS US 301 MAINLINE STA. 487 + 50	SHEET NO.
					T20091303		
				COUNTY	DESIGNED BY: SS		TOTAL SHTS.
				NEW CASTLE	CHECKED BY: AM		518

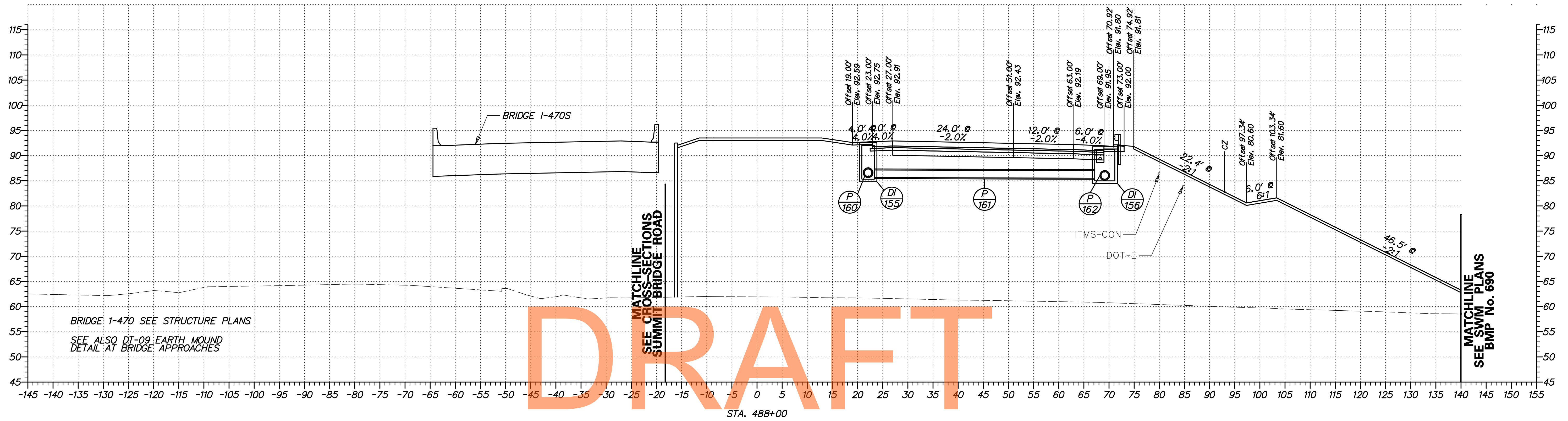

DRAFT

NOT FOR BIDDING

AUGUST 2015

G:\60049040 US301\CIVIL\PLANS\2A\XSEC\X5296.DGN

DELAWARE DEPARTMENT OF TRANSPORTATION	ADDENDUMS / REVISIONS	SCALE FEET	US 301 LEVELS ROAD TO SUMMIT BRIDGE ROAD	CONTRACT T20091303	BRIDGE NO.	CROSS SECTIONS US 301 MAINLINE STA. 488 + 00	SHEET NO. 310
					COUNTY NEW CASTLE		DESIGNED BY: SS
				CHECKED BY: AM			

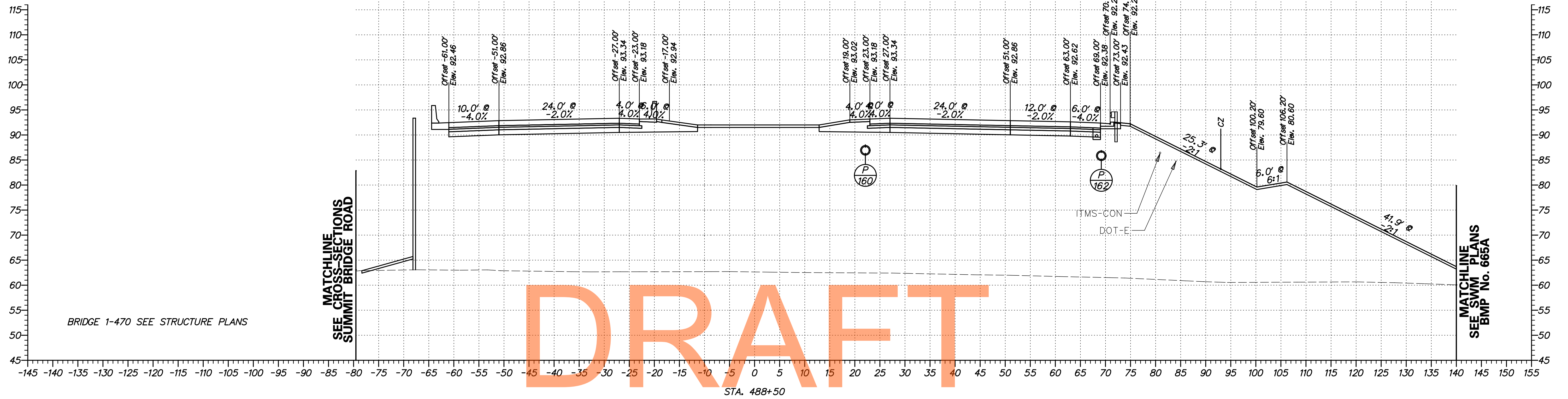

DRAFT

NOT FOR BIDDING

AUGUST 2015

G:\60049040 US301\CIVIL\PLANS\2A\XSEC\XS297.DGN

<p>DELAWARE DEPARTMENT OF TRANSPORTATION</p>	ADDENDUMS / REVISIONS	<p>SCALE</p> <p>FEET</p>	<p>US 301 LEVELS ROAD TO SUMMIT BRIDGE ROAD</p>	CONTRACT	BRIDGE NO.	<p>CROSS SECTIONS US 301 MAINLINE STA. 488 + 50</p>	SHEET NO.
				T20091303	DESIGNED BY: SS		311
		NEW CASTLE	CHECKED BY: AM	TOTAL SHTS.			
						518	

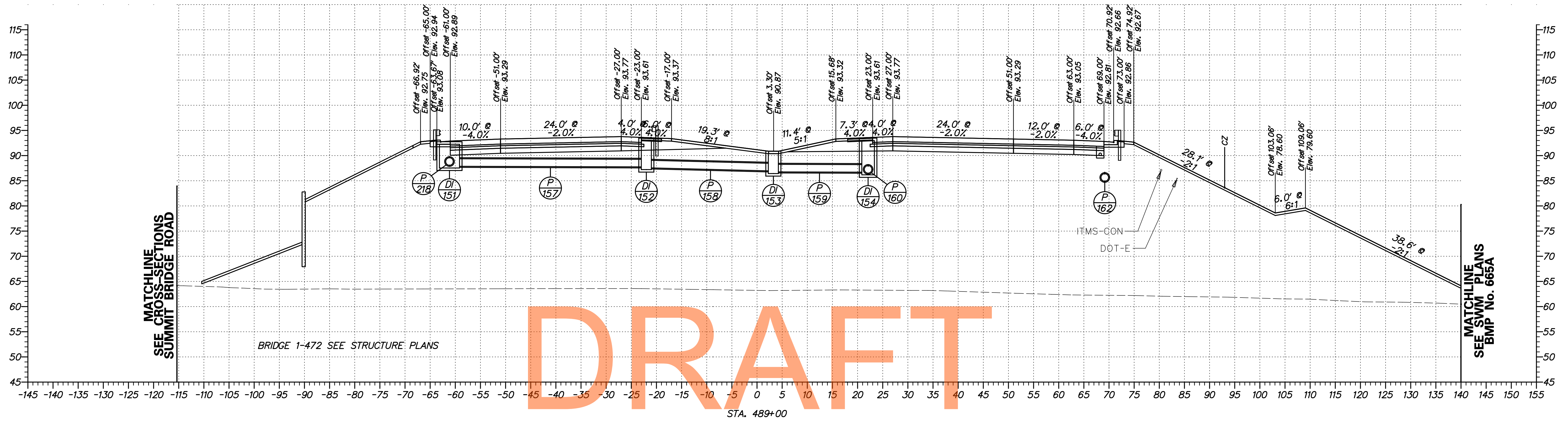

DRAFT

NOT FOR BIDDING
AUGUST 2015

G:\60049040 US301\CIVIL\PLANS\2A\YSEC\XS298.DGN

ADDENDUMS / REVISIONS	

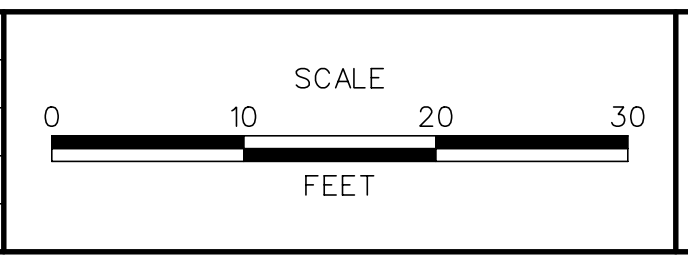

CONTRACT	BRIDGE NO.
T20091303	
COUNTY	DESIGNED BY: SS
NEW CASTLE	CHECKED BY: AM

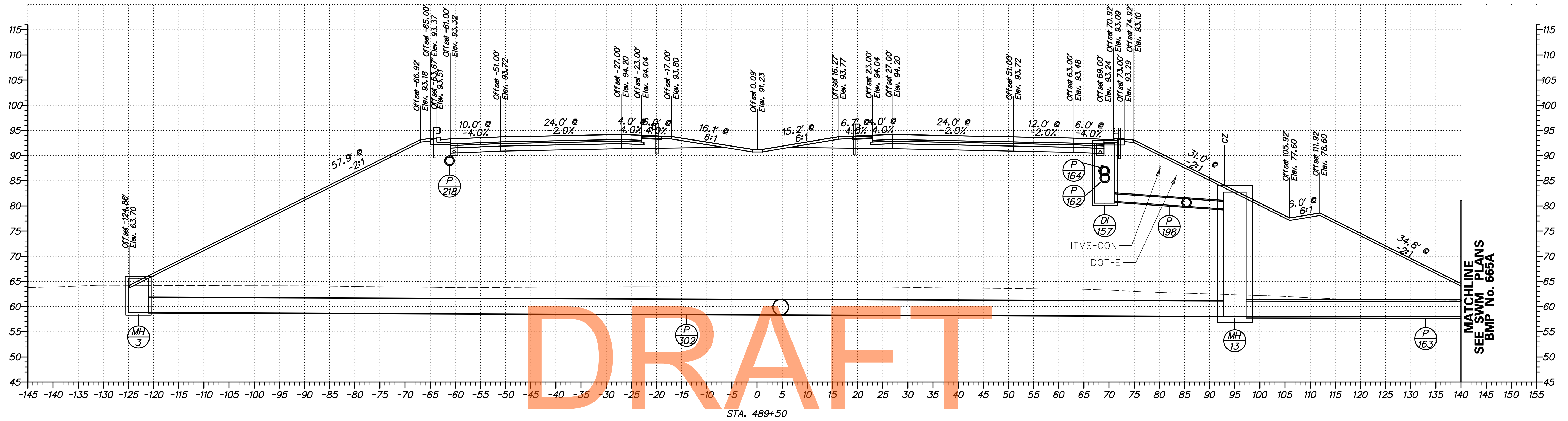

DRAFT

NOT FOR BIDDING

AUGUST 2015

G:\60049040 US301\CIVIL\PLANS\2A\YSEC\XS299.DGN

DELAWARE DEPARTMENT OF TRANSPORTATION	ADDENDUMS / REVISIONS	SCALE FEET	US 301 LEVELS ROAD TO SUMMIT BRIDGE ROAD	CONTRACT T20091303	BRIDGE NO.	CROSS SECTIONS US 301 MAINLINE STA. 489 + 50	SHEET NO. 313
					COUNTY NEW CASTLE		DESIGNED BY: SS

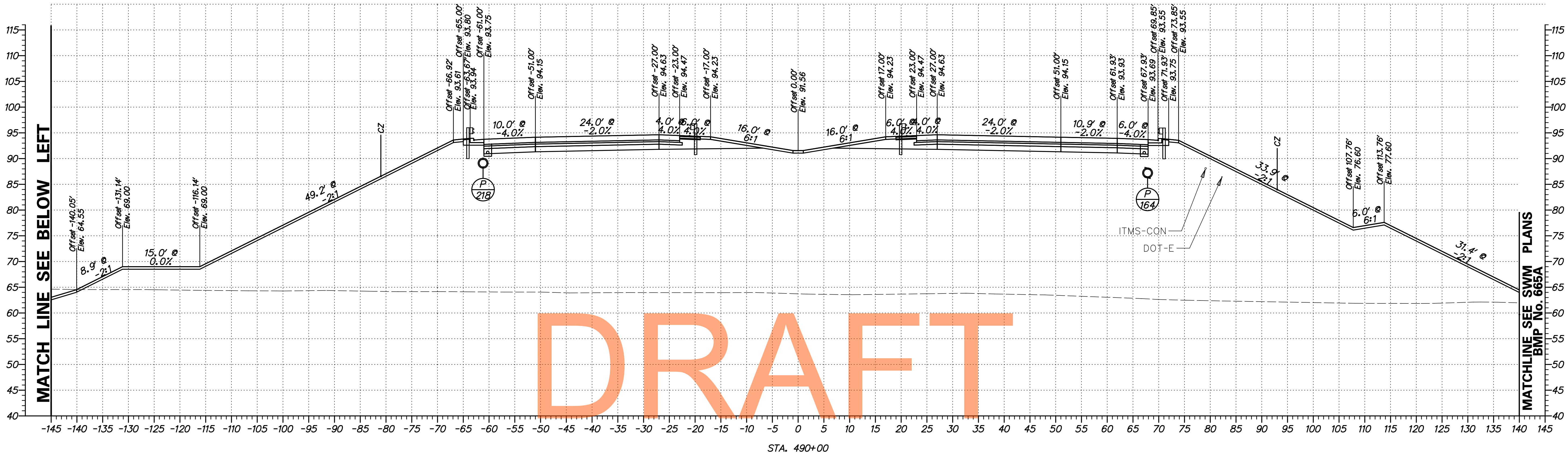

DRAFT

NOT FOR BIDDING

AUGUST 2015

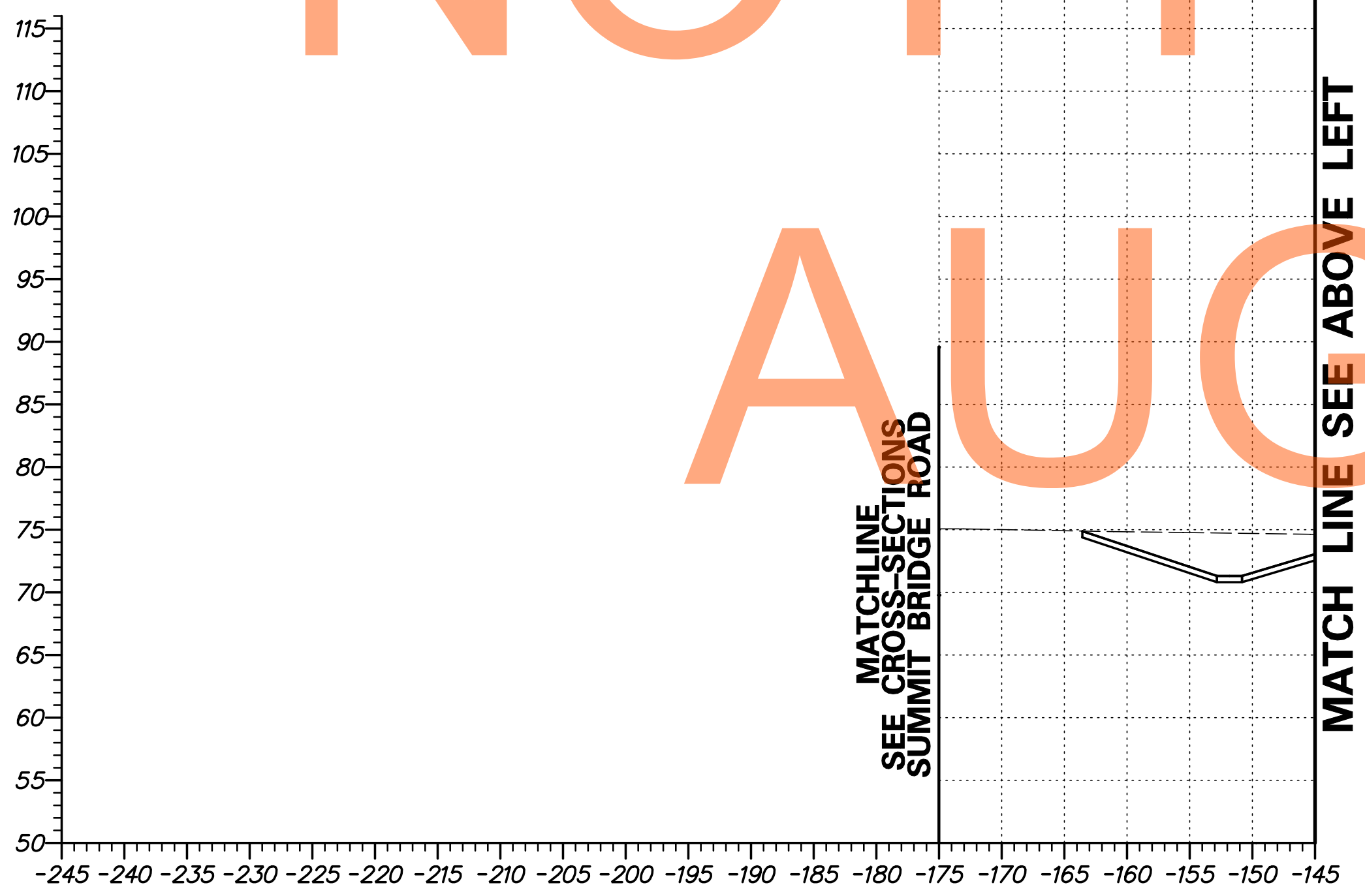

G:\60049040 US301\CIVIL\PLANS\2A\XSEC\XS300.DGN

	ADDENDUMS / REVISIONS		SCALE 0 10 20 30 FEET	US 301 LEVELS ROAD TO SUMMIT BRIDGE ROAD	CONTRACT T20091303	BRIDGE NO. _____	CROSS SECTIONS US 301 MAINLINE STA. 490 + 00	SHEET NO. 314
	COUNTY NEW CASTLE	DESIGNED BY: SS			CHECKED BY: AM	TOTAL SHTS. 518		

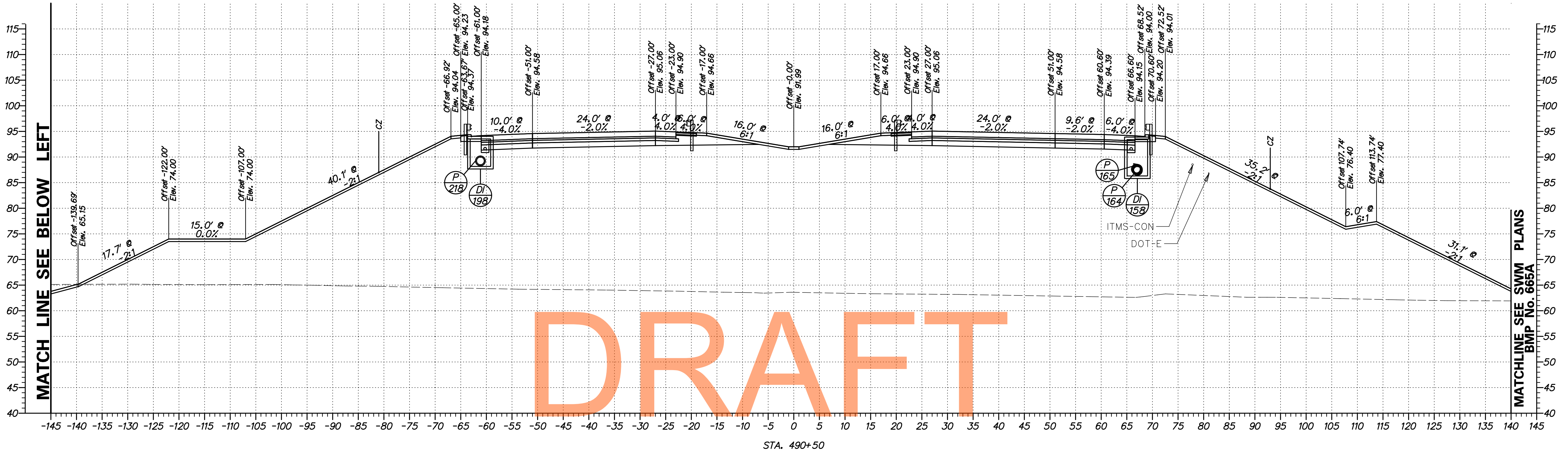

DRAFT

NOT FOR BIDDING

AUGUST 2015

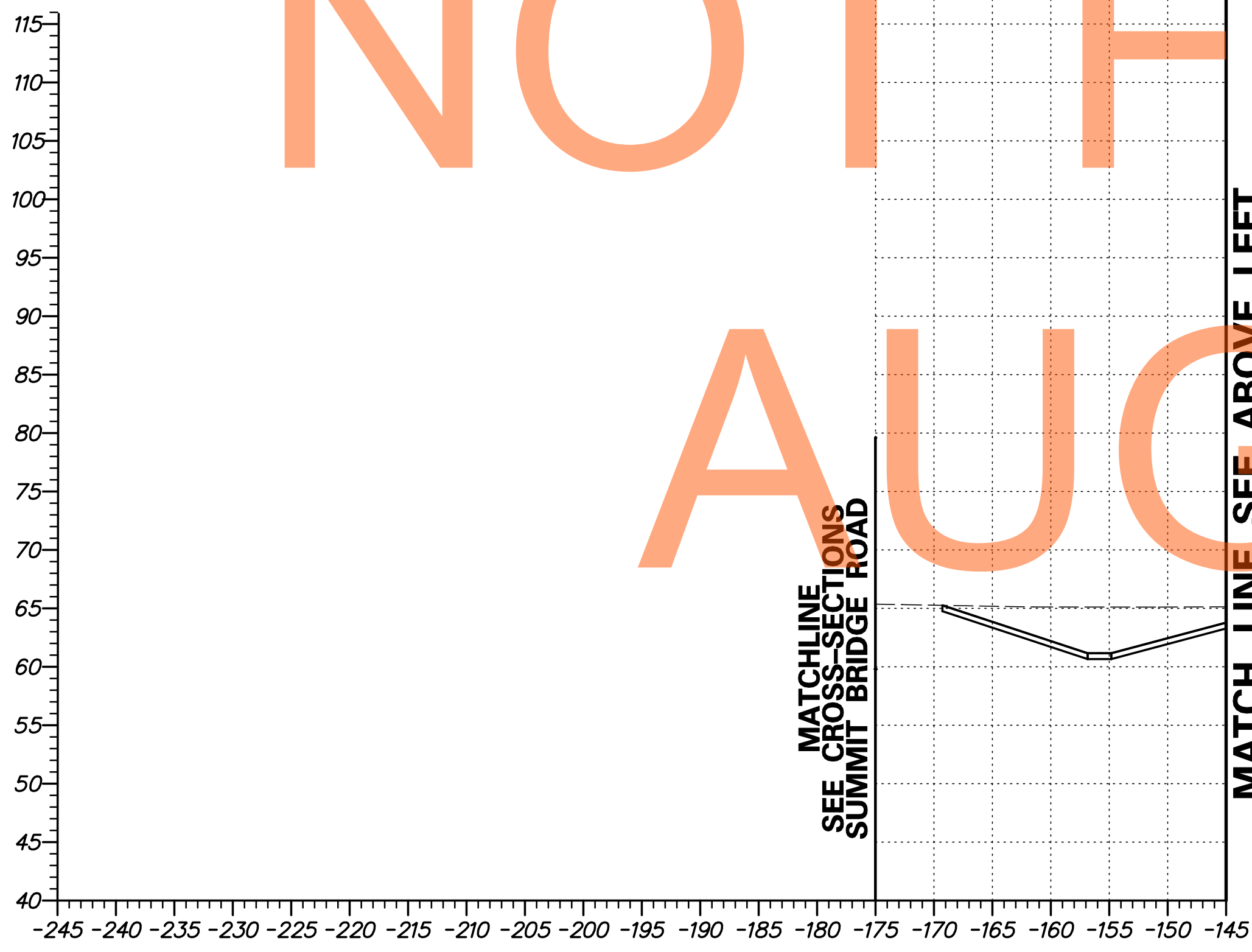

G:\60049040 US301\CIVIL\PLANS\2A\XSEC\XS301.DGN

DELAWARE DEPARTMENT OF TRANSPORTATION	ADDENDUMS / REVISIONS	SCALE FEET	US 301 LEVELS ROAD TO SUMMIT BRIDGE ROAD	CONTRACT T20091303	BRIDGE NO. _____	CROSS SECTIONS US 301 MAINLINE STA. 490 + 50	SHEET NO. 315
				COUNTY NEW CASTLE	DESIGNED BY: SS CHECKED BY: AM		TOTAL SHTS. 518

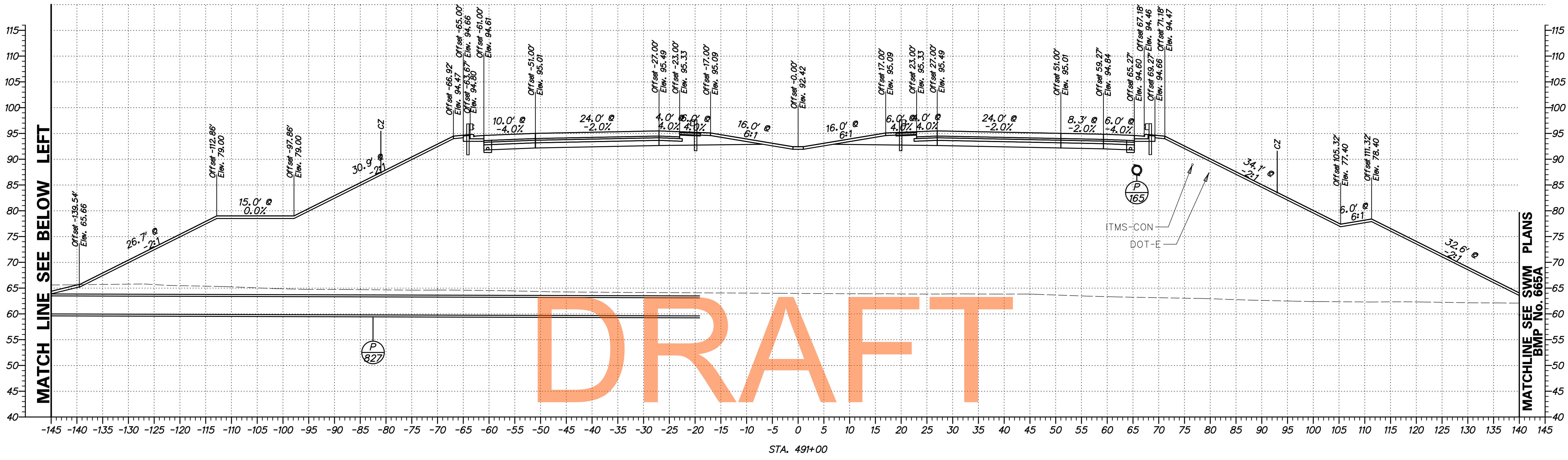

DRAFT

NOT FOR BIDDING

AUGUST 2015

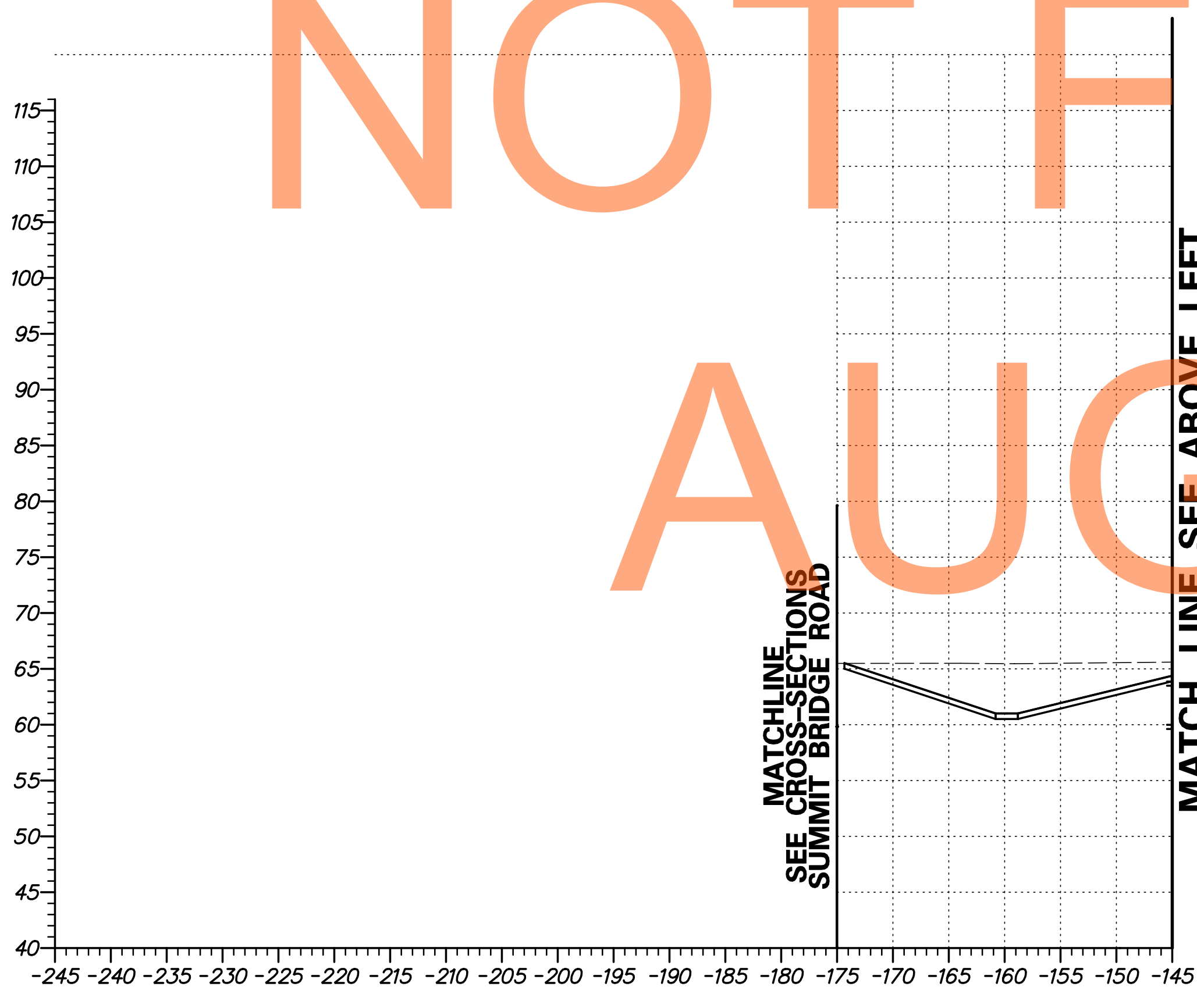

G:\60049040 US301\CIVIL\PLANS\2A\YSEC\XS302.DGN

	ADDENDUMS / REVISIONS		SCALE 0 10 20 30 FEET	US 301 LEVELS ROAD TO SUMMIT BRIDGE ROAD	CONTRACT T20091303	BRIDGE NO.	CROSS SECTIONS US 301 MAINLINE STA. 491+00	SHEET NO. 316
	COUNTY NEW CASTLE	DESIGNED BY: SS CHECKED BY: AM			TOTAL SHTS. 518			

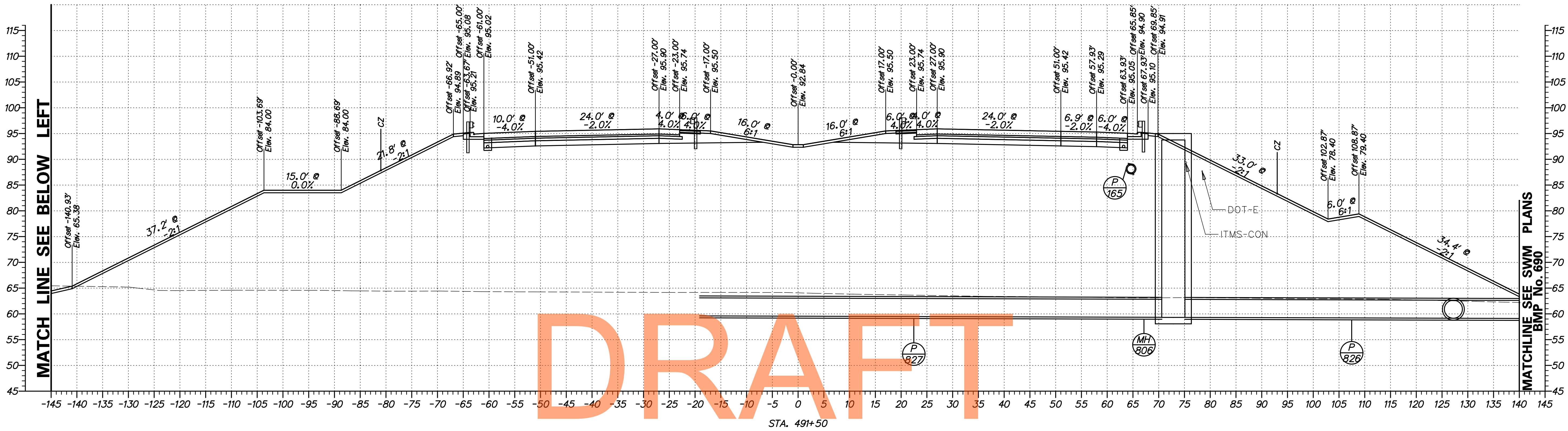

DRAFT

NOT FOR BIDDING

AUGUST 2015

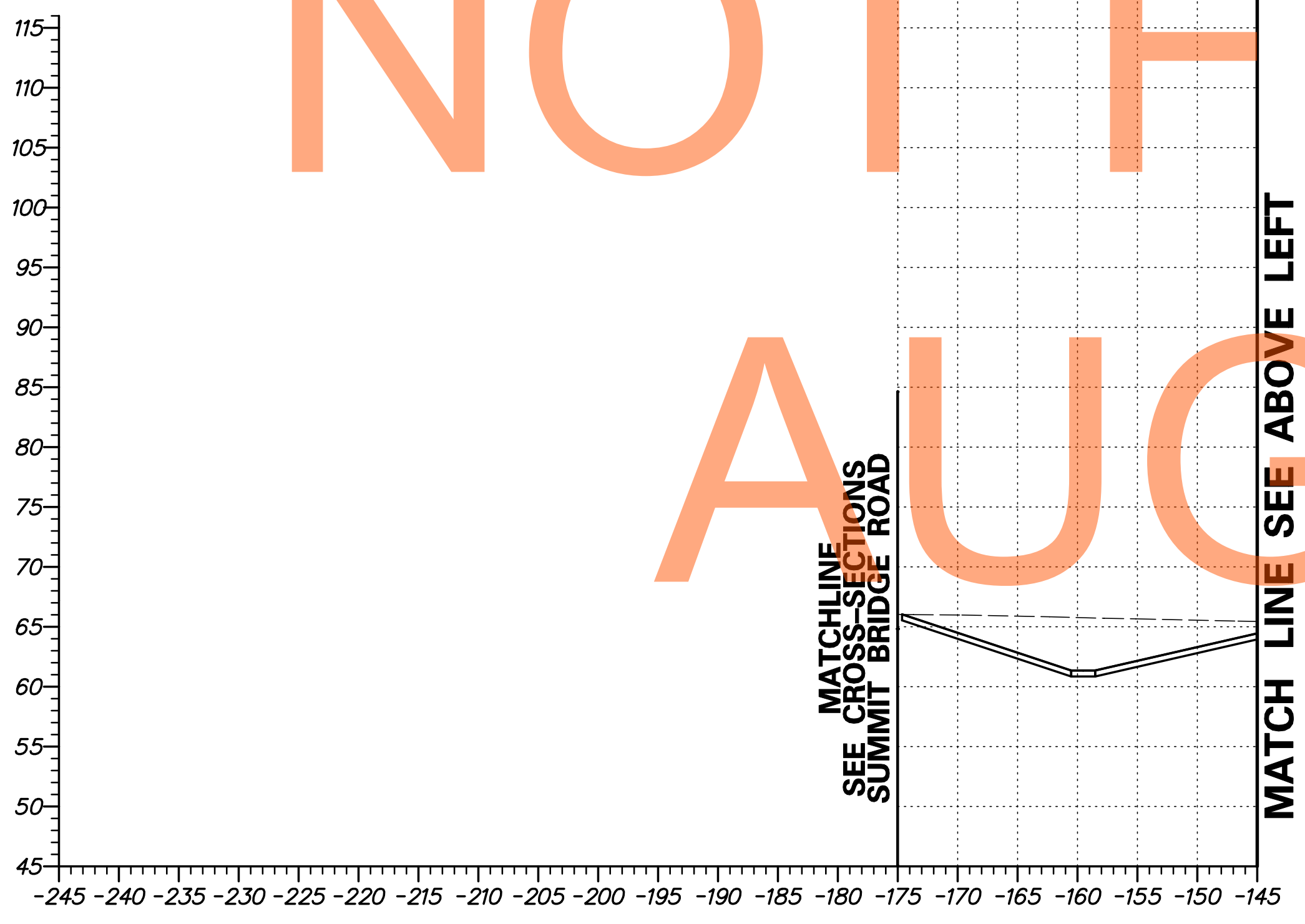

G:\60049040 US301\CIVIL\PLANS\2A\XSEC\XS303.DGN

DELAWARE DEPARTMENT OF TRANSPORTATION	ADDENDUMS / REVISIONS	SCALE FEET	US 301 LEVELS ROAD TO SUMMIT BRIDGE ROAD	CONTRACT T20091303	BRIDGE NO. DESIGNED BY: SS CHECKED BY: AM	CROSS SECTIONS US 301 MAINLINE STA. 491 + 50	SHEET NO. 317 TOTAL SHTS. 518

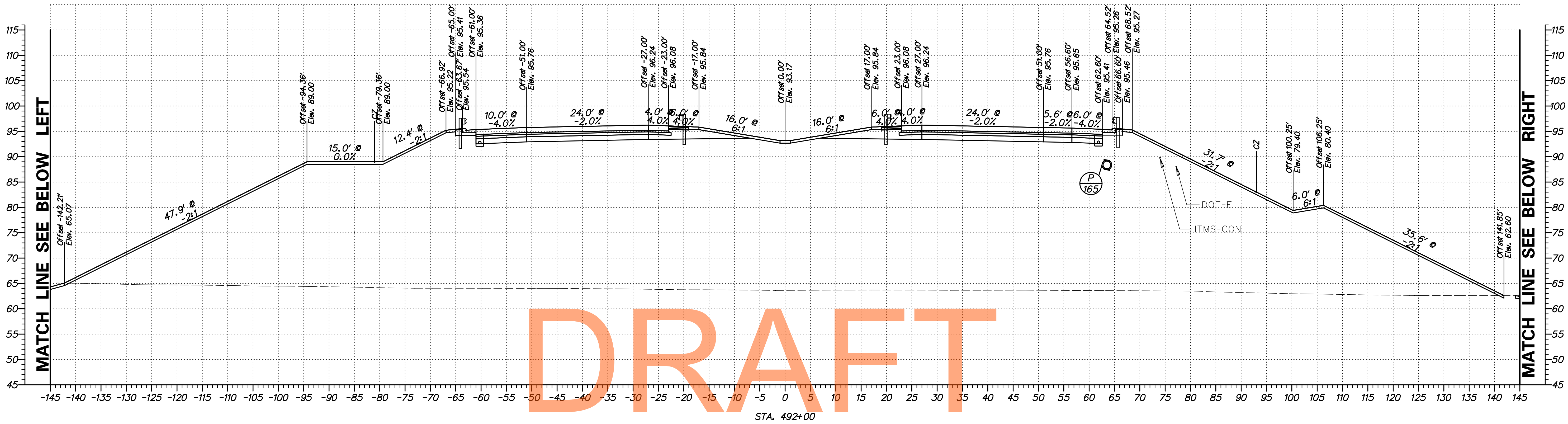

DRAFT

NOT FOR BIDDING
AUGUST 2015

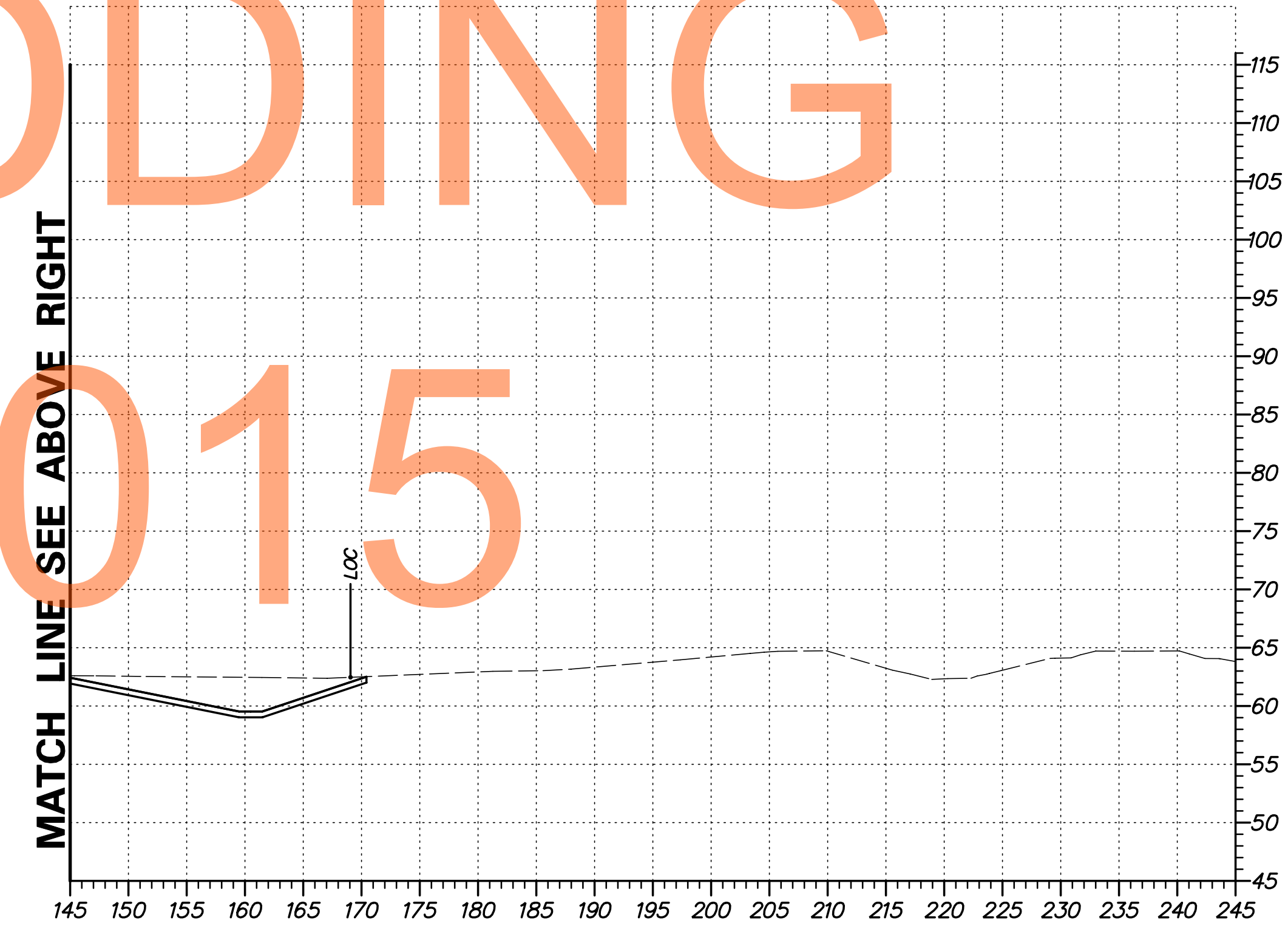
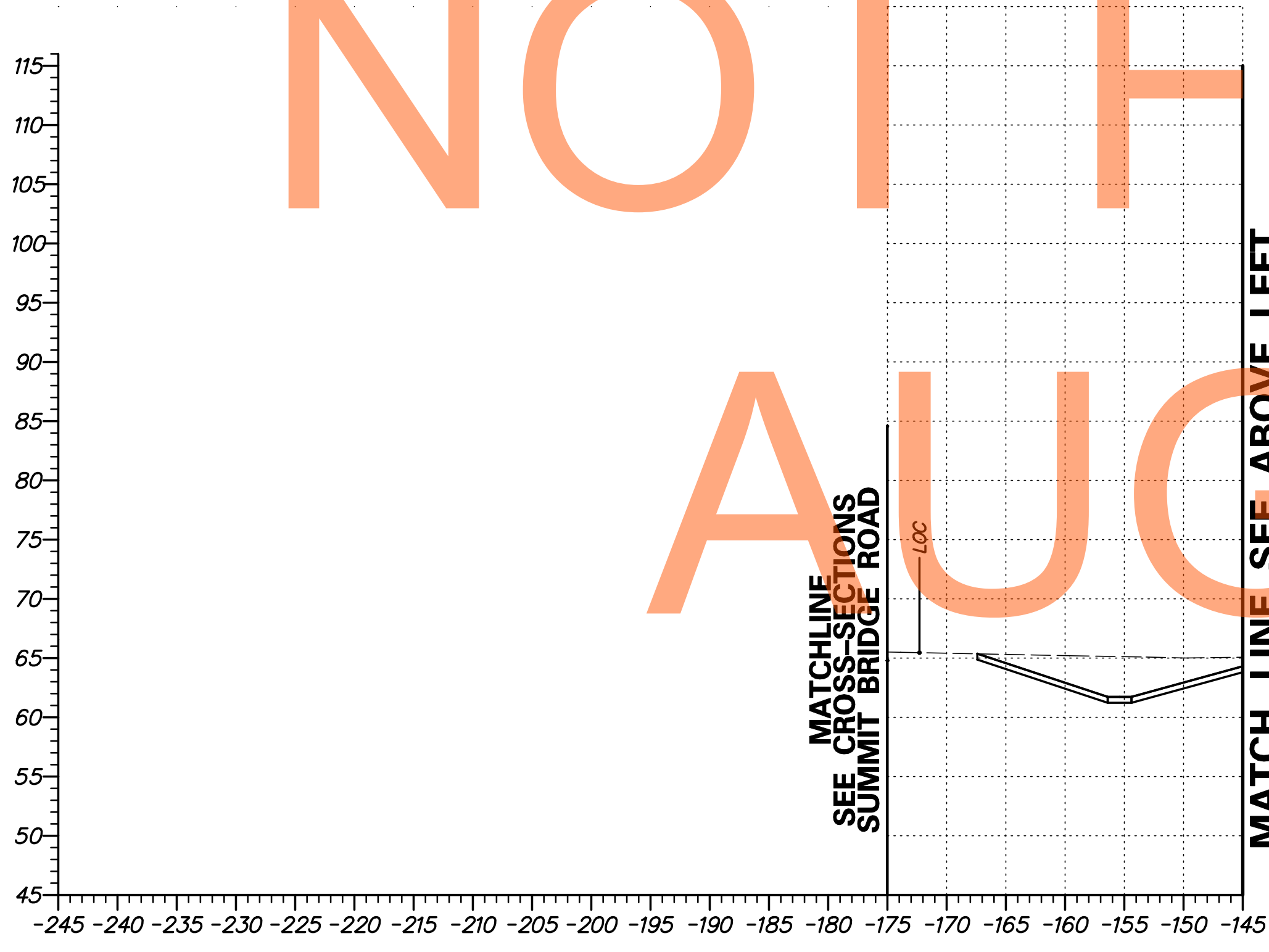

G:\60049040 US301\CIVIL\PLANS\2A\XSEC\XS304.DGN

ADDENDUMS / REVISIONS	

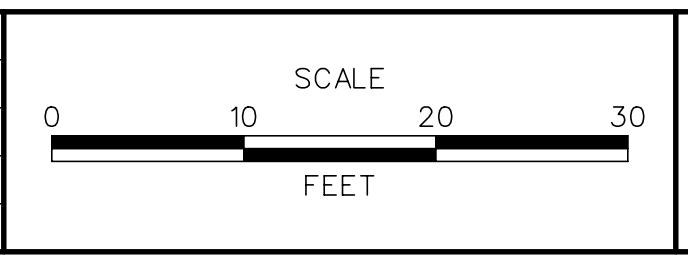

CONTRACT T20091303	BRIDGE NO.
COUNTY NEW CASTLE	DESIGNED BY: SS
	CHECKED BY: AM

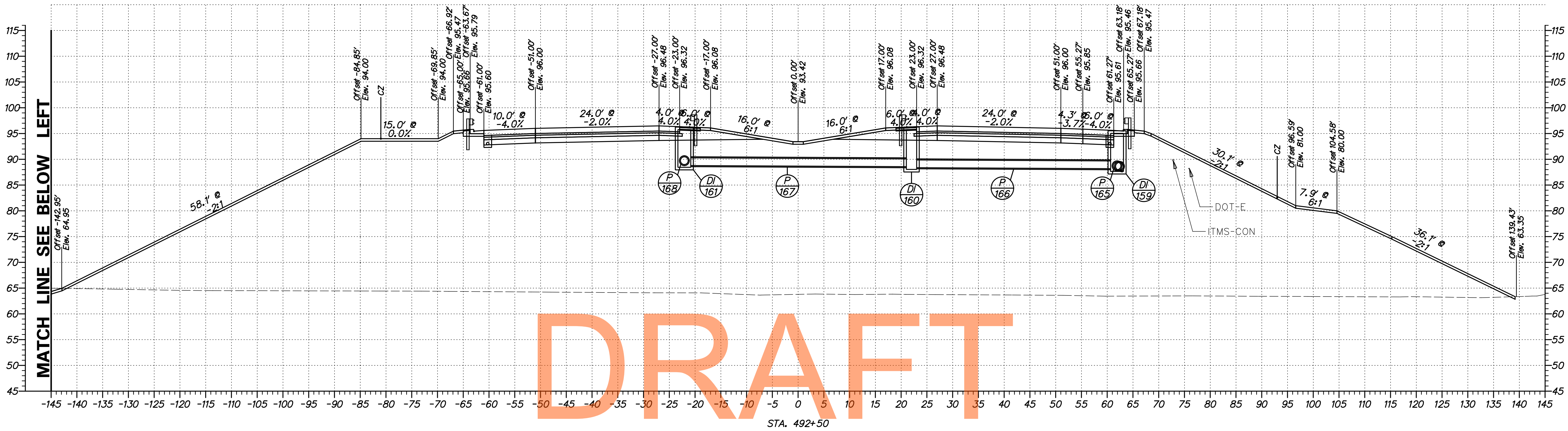

DRAFT

NOT FOR BIDDING
AUGUST 2015

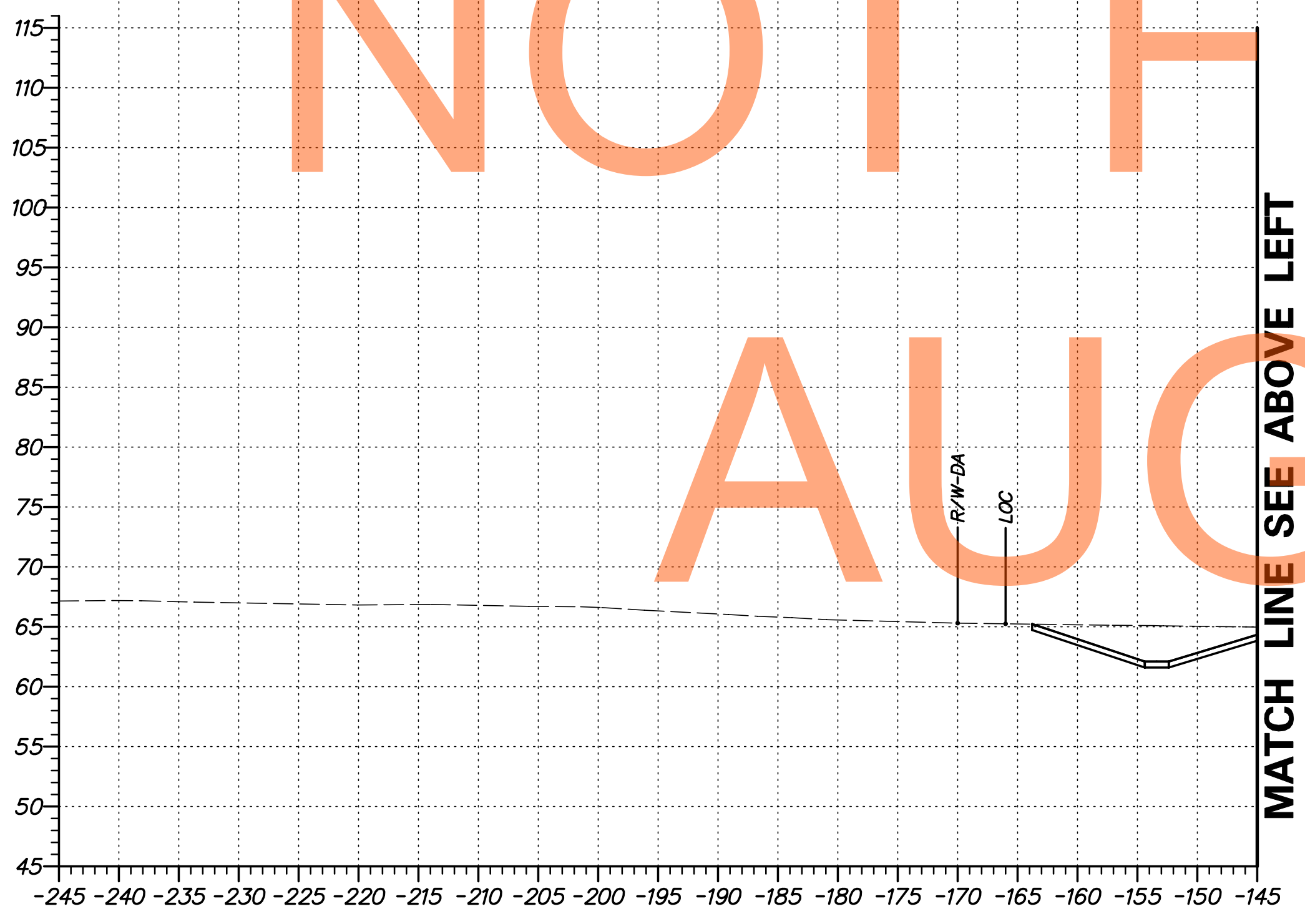

G:\60049040 US301\CIVIL\PLANS\2A\YSEC\XS305.DGN

DELAWARE DEPARTMENT OF TRANSPORTATION	ADDENDUMS / REVISIONS	SCALE 0 10 20 30 FEET	US 301 LEVELS ROAD TO SUMMIT BRIDGE ROAD	CONTRACT	BRIDGE NO.	CROSS SECTIONS US 301 MAINLINE STA. 492 + 50	SHEET NO.
					T20091303		DESIGNED BY: SS
				COUNTY	CHECKED BY: AM	TOTAL SHTS.	518
				NEW CASTLE			

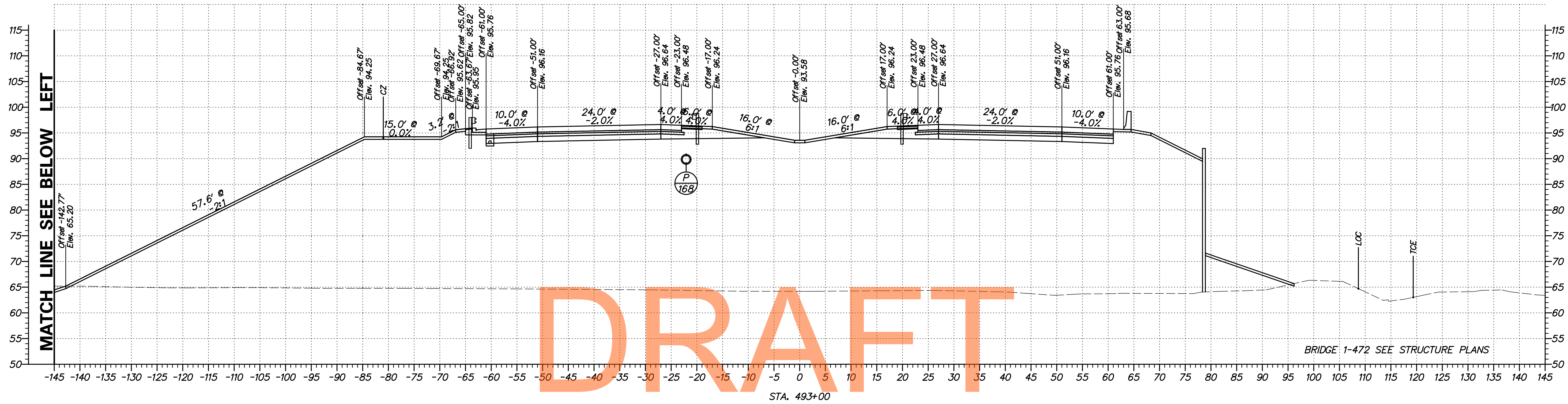

NOT FOR BIDDING

AUGUST 2015

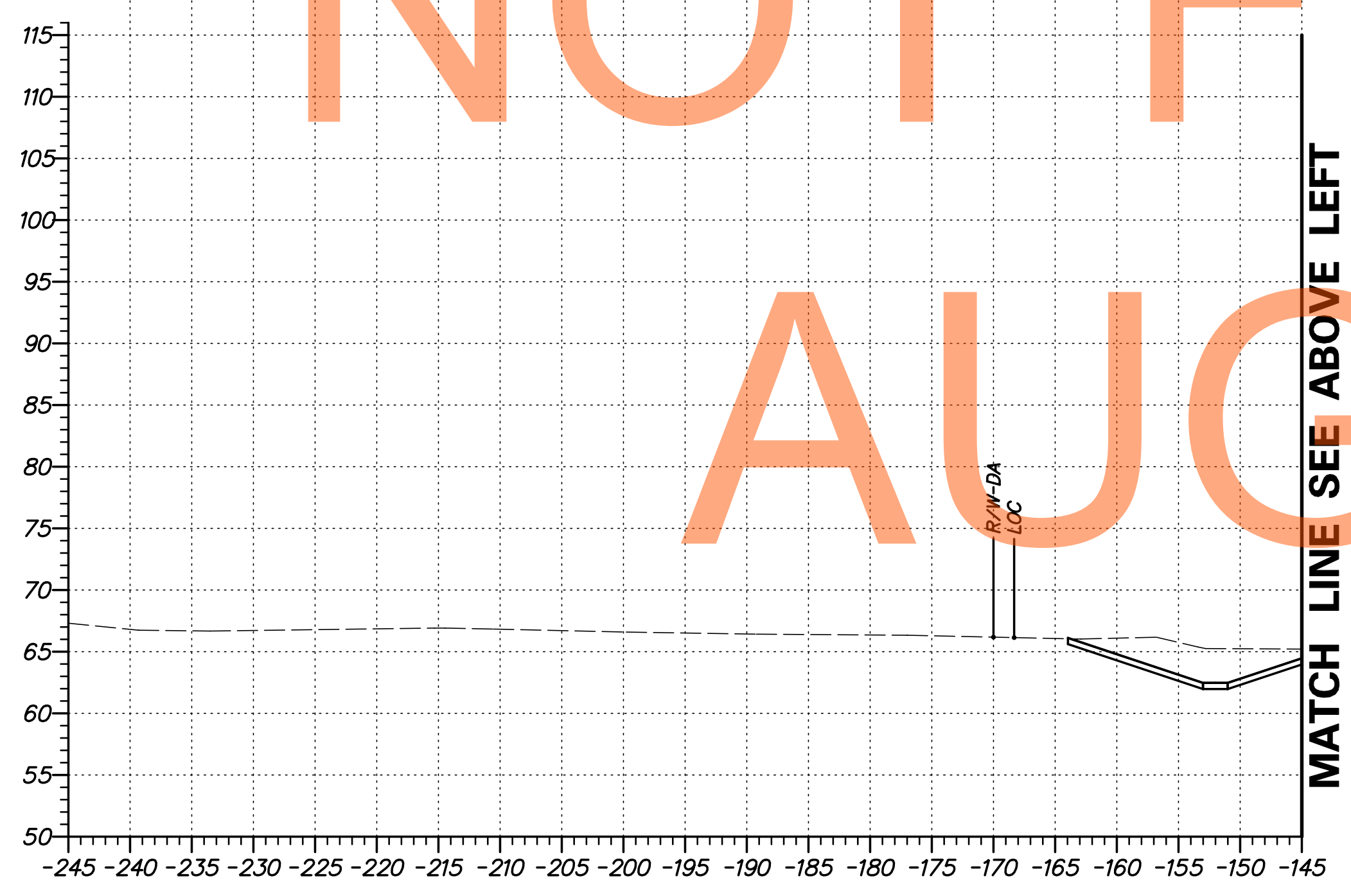

G:\60049040 US301\CIVIL\PLANS\2A\XSEC\XS306.DGN

	ADDENDUMS / REVISIONS		SCALE 0 10 20 30 FEET	US 301 LEVELS ROAD TO SUMMIT BRIDGE ROAD	CONTRACT	BRIDGE NO.	CROSS SECTIONS US 301 MAINLINE STA. 493 + 00	SHEET NO.
					T20091303	DESIGNED BY: SS		320
					COUNTY	CHECKED BY: AM	TOTAL SHTS.	
					NEW CASTLE		518	

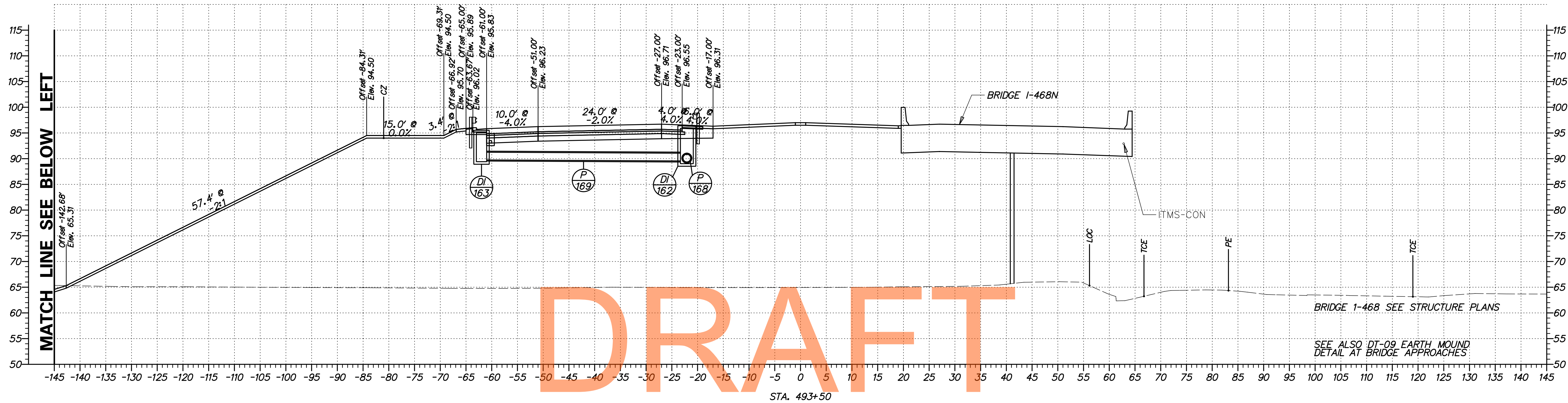

DRAFT

NOT FOR BIDDING

AUGUST 2015

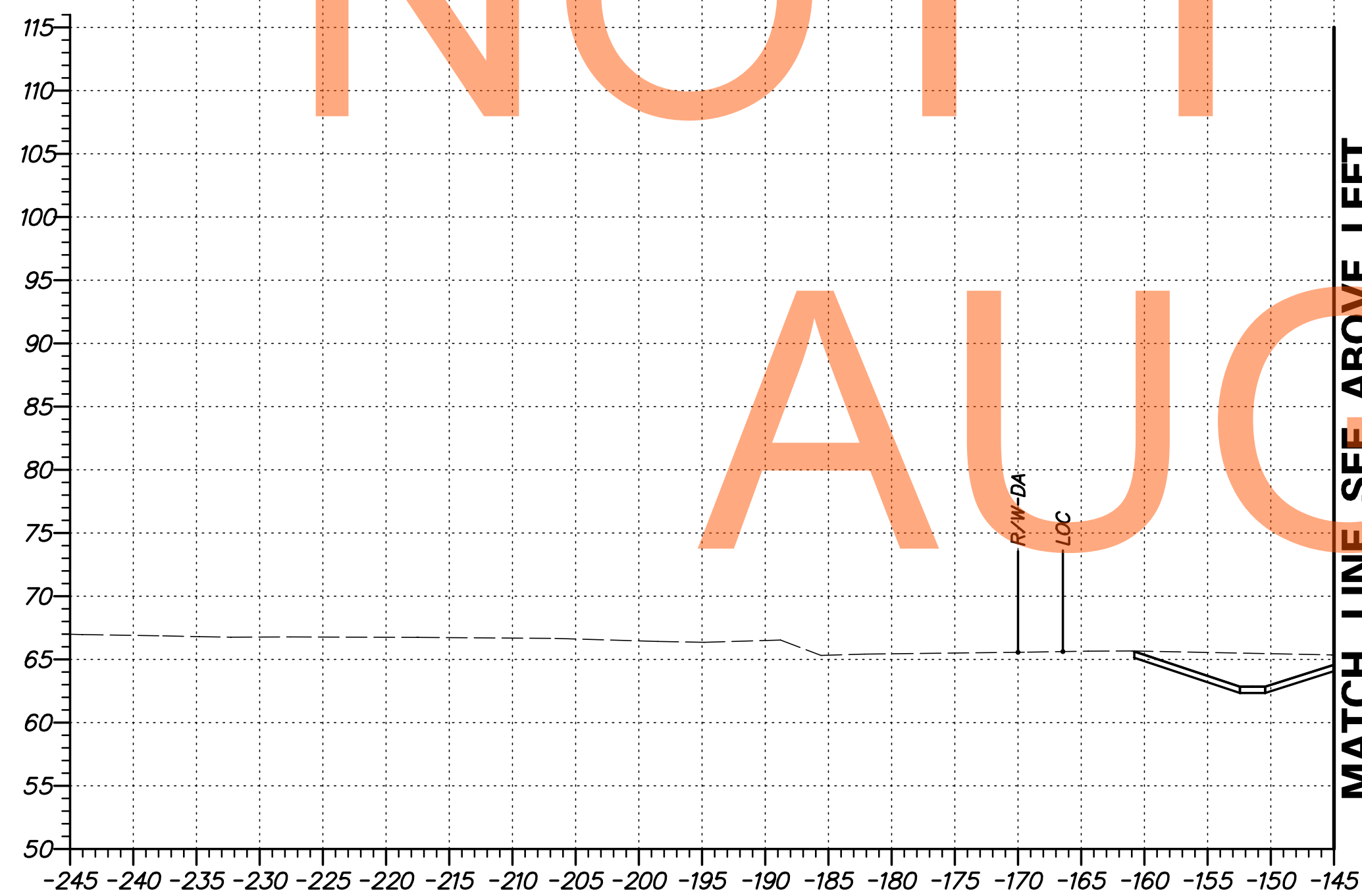

G:\60049040 US301\CIVIL\PLANS\2A\XSEC\XS307.DGN

DELAWARE DEPARTMENT OF TRANSPORTATION	ADDENDUMS / REVISIONS	SCALE FEET	US 301 LEVELS ROAD TO SUMMIT BRIDGE ROAD	CONTRACT T20091303 COUNTY NEW CASTLE	BRIDGE NO. DESIGNED BY: SS CHECKED BY: AM	CROSS SECTIONS US 301 MAINLINE STA. 493 + 50	SHEET NO. 321 TOTAL SHTS. 518

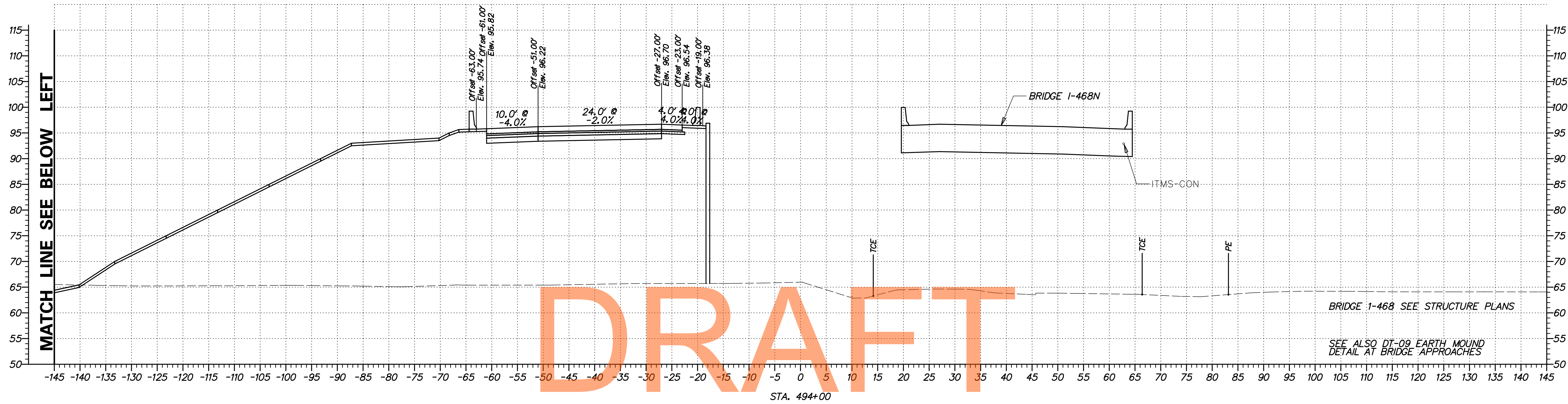

DRAFT

NOT FOR BIDDING

AUGUST 2015

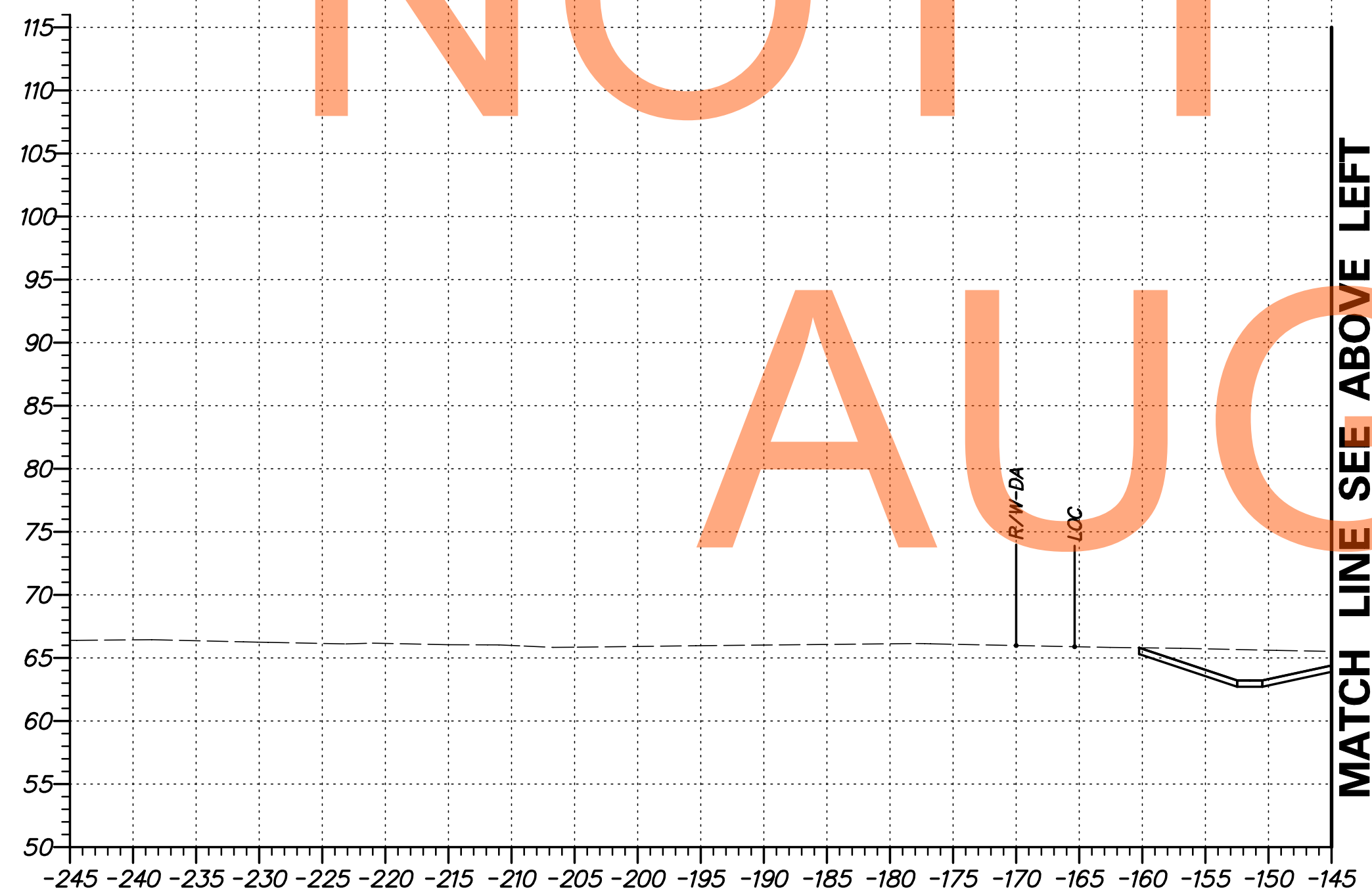

G:\60049040 US301\CIVIL\PLANS\2A\XSEC\XS308.DGN

<p>DELAWARE DEPARTMENT OF TRANSPORTATION</p>	ADDENDUMS / REVISIONS	<p>SCALE</p>	<p>US 301 LEVELS ROAD TO SUMMIT BRIDGE ROAD</p>	<table border="1" style="width: 100%;"> <tr><td>CONTRACT</td><td>BRIDGE NO.</td></tr> <tr><td>T20091303</td><td></td></tr> <tr><td>COUNTY</td><td>DESIGNED BY: SS</td></tr> <tr><td>NEW CASTLE</td><td>CHECKED BY: AM</td></tr> </table>	CONTRACT	BRIDGE NO.	T20091303		COUNTY	DESIGNED BY: SS	NEW CASTLE	CHECKED BY: AM	<p>CROSS SECTIONS US 301 MAINLINE STA. 494 + 00</p>	<table border="1" style="width: 100%;"> <tr><td>SHEET NO.</td></tr> <tr><td>322</td></tr> <tr><td>TOTAL SHTS.</td></tr> <tr><td>518</td></tr> </table>	SHEET NO.	322	TOTAL SHTS.	518
	CONTRACT		BRIDGE NO.															
T20091303																		
COUNTY	DESIGNED BY: SS																	
NEW CASTLE	CHECKED BY: AM																	
SHEET NO.																		
322																		
TOTAL SHTS.																		
518																		

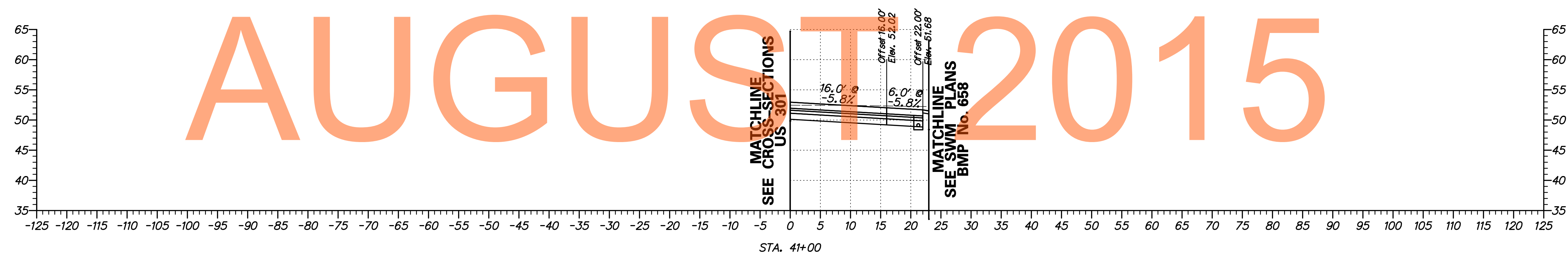
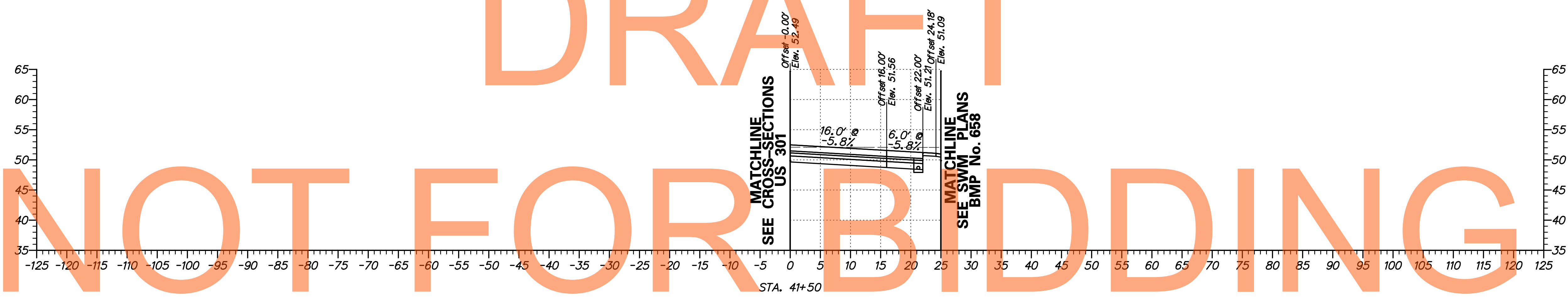
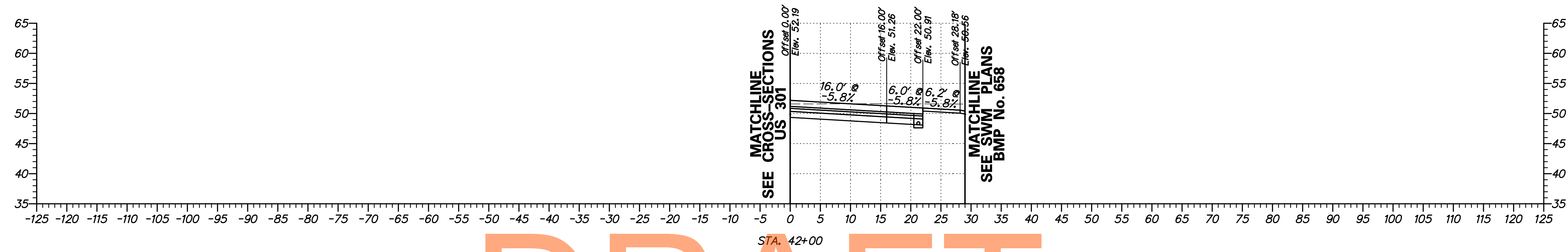

DRAFT
NOT FOR BIDDING
AUGUST 2015

G:\60049040 US301\CIVIL\PLANS\2A\YSEC\XS-F01-2A.DGN

DELAWARE DEPARTMENT OF TRANSPORTATION	ADDENDUMS / REVISIONS	SCALE FEET	US 301 LEVELS ROAD TO SUMMIT BRIDGE ROAD	CONTRACT	BRIDGE NO.	CROSS SECTIONS US 301 RAMP F STA. 41+00 - 42+00	SHEET NO.
					T20091303		
				COUNTY	DESIGNED BY: SS	TOTAL SHTS.	
				NEW CASTLE	CHECKED BY: AM	518	

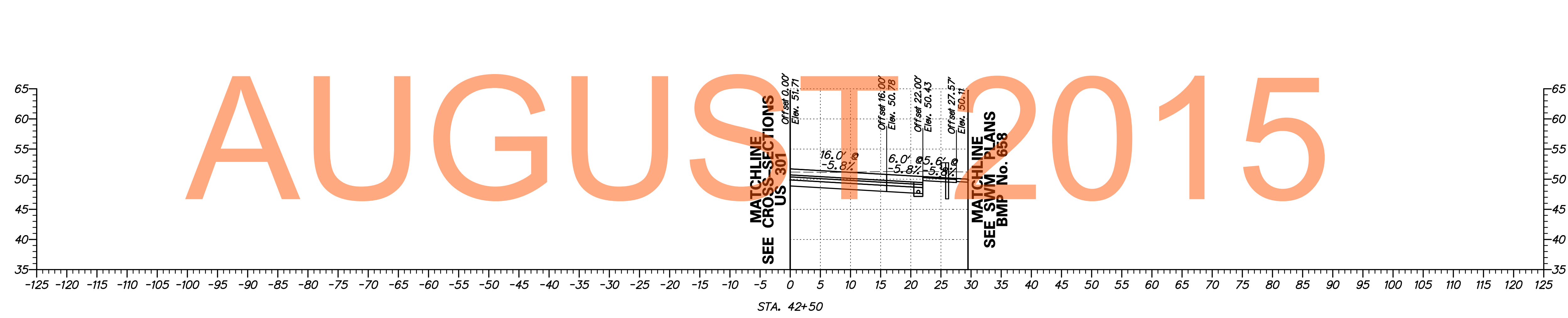
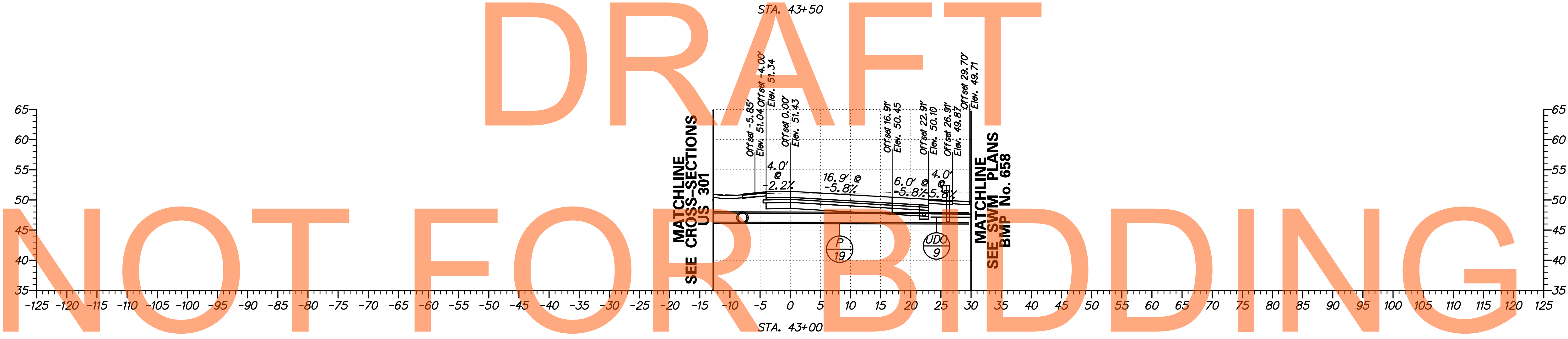
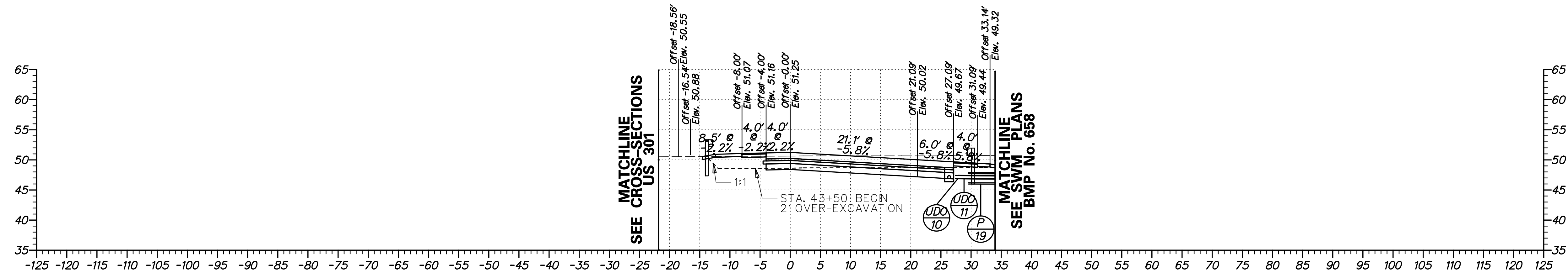

DRAFT
NOT FOR BIDDING
AUGUST 2015

G:\60049040 US301\CIVIL\PLANS\2A\YSEC\XS-F02_2A.DGN

DELAWARE DEPARTMENT OF TRANSPORTATION	ADDENDUMS / REVISIONS	SCALE FEET	US 301 LEVELS ROAD TO SUMMIT BRIDGE ROAD	CONTRACT	BRIDGE NO.	CROSS SECTIONS US 301 RAMP F STA. 42+50 - 43+50	SHEET NO.
					T20091303		
				COUNTY	DESIGNED BY: SS	TOTAL SHTS.	
				NEW CASTLE	CHECKED BY: AM	518	

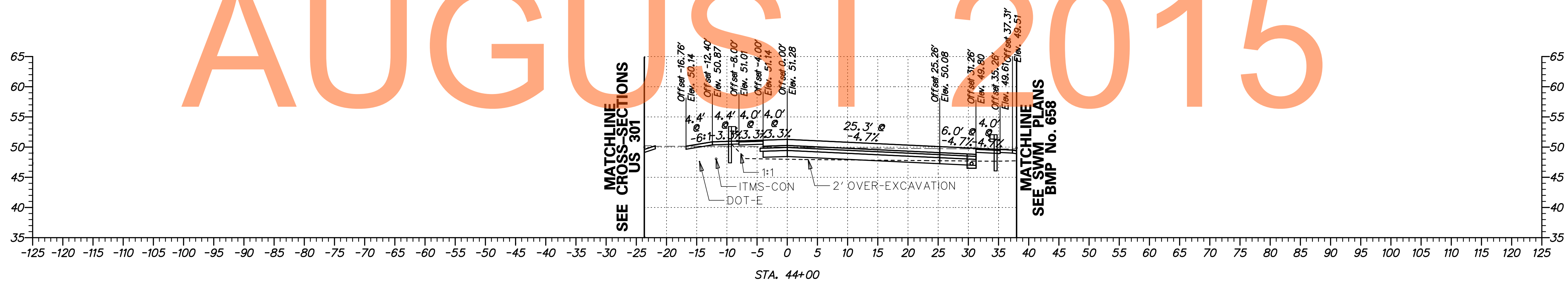
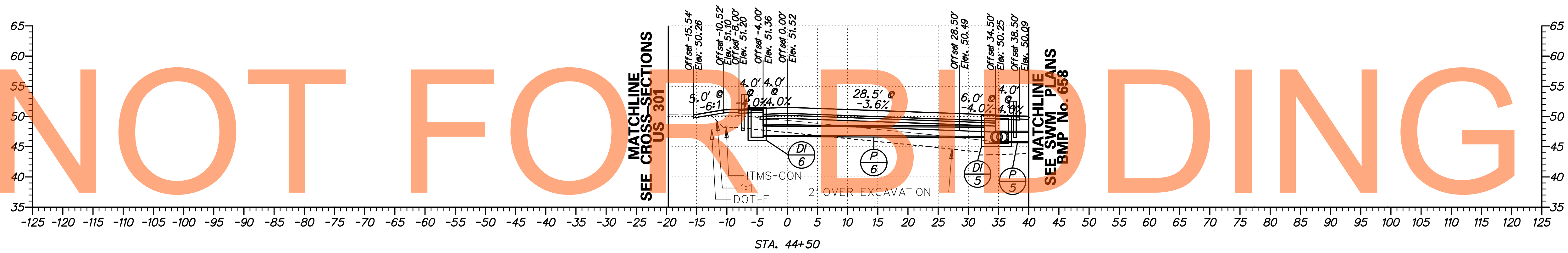
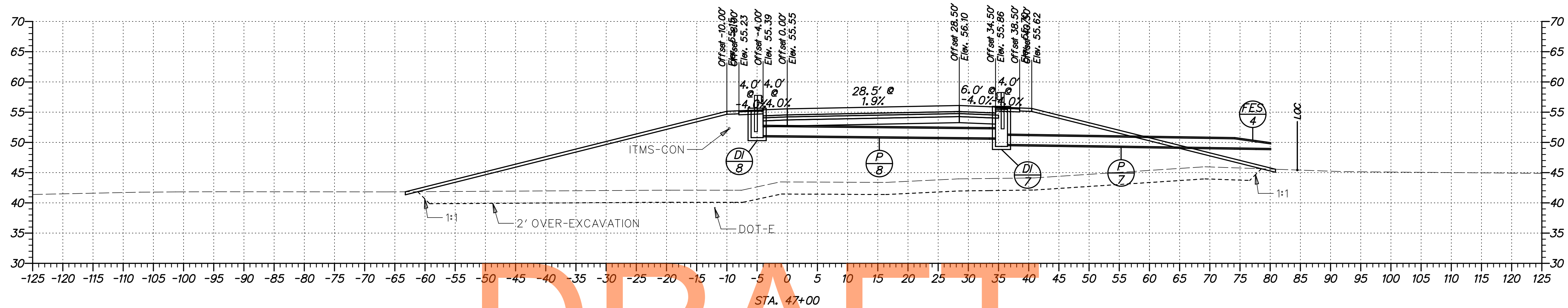

DRAFT

NOT FOR BIDDING

AUGUST 2015

G:\60049040 US301\CIVIL\PLANS\2A\XSEC\XS_F03_2A.DGN



ADDENDUMS / REVISIONS	

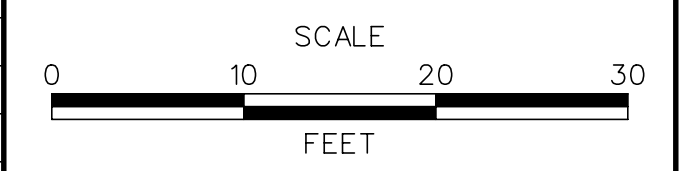

US 301
LEVELS ROAD
TO SUMMIT BRIDGE ROAD

CONTRACT	BRIDGE NO.
T20091303	
COUNTY	DESIGNED BY: SS
NEW CASTLE	CHECKED BY: AM

CROSS SECTIONS
US 301 RAMP F
STA. 44+00 - 44+50
AND STA. 47+00

SHEET NO.
325
TOTAL SHTS.
518

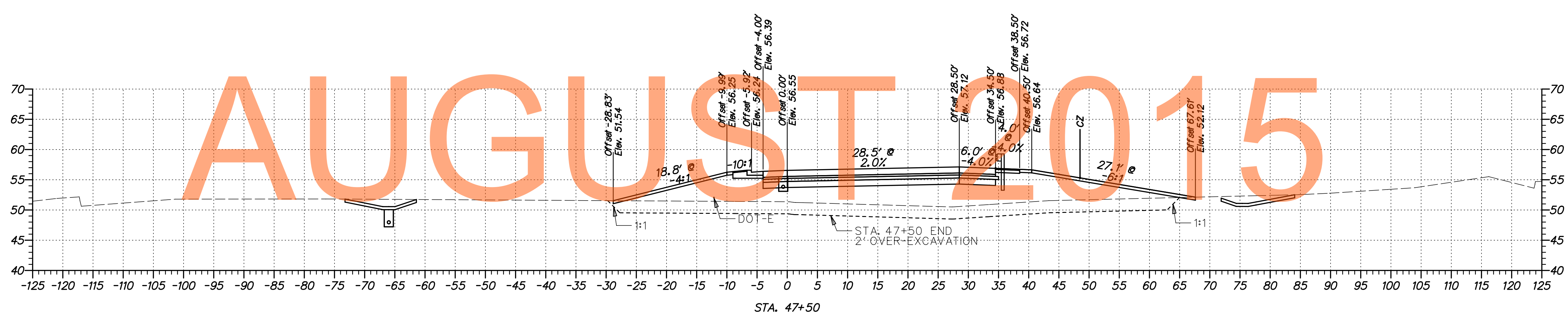
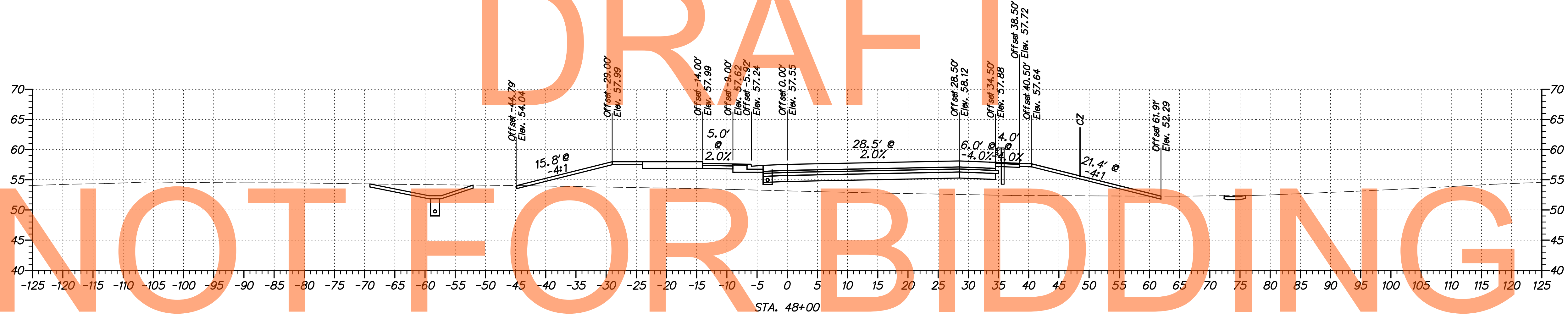
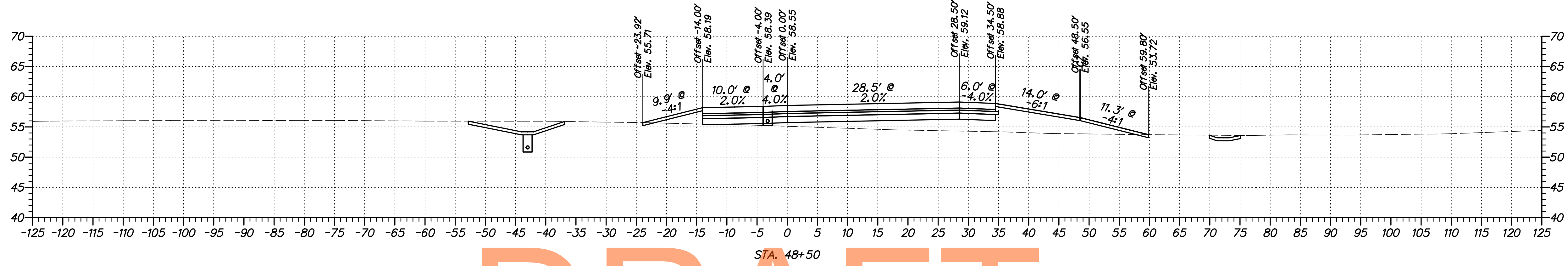

DRAFT
NOT FOR BIDDING
AUGUST 2015

G:\60049040 US301\CIVIL\PLANS\2A\YSEC\XS-F06_2A.DGN

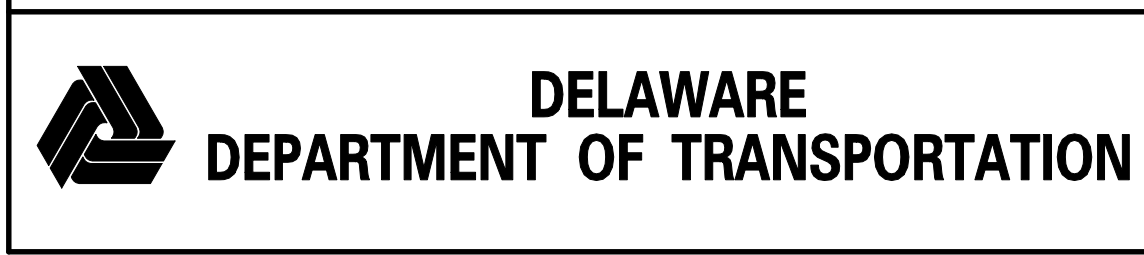

ADDENDUMS / REVISIONS	

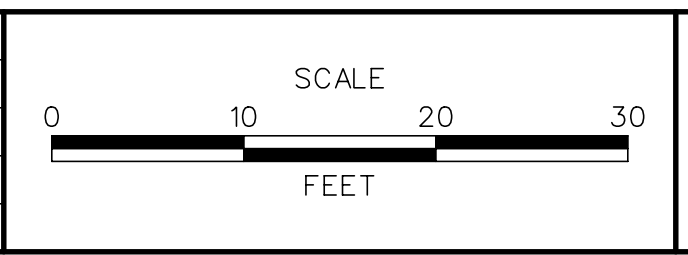

**US 301
LEVELS ROAD
TO SUMMIT BRIDGE ROAD**

CONTRACT	BRIDGE NO.
T200911303	
COUNTY	DESIGNED BY: SS
NEW CASTLE	CHECKED BY: AM

**CROSS SECTIONS
US 301 RAMP F
STA. 47+50 - 48+50**

SHEET NO.
326
TOTAL SHTS.
518

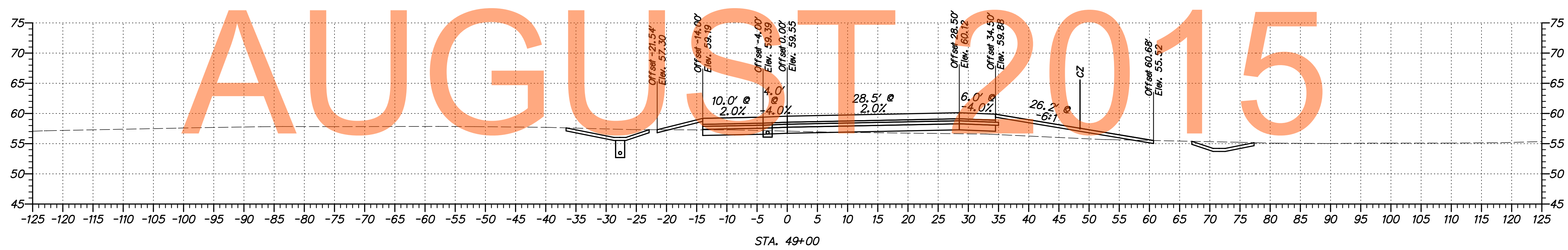
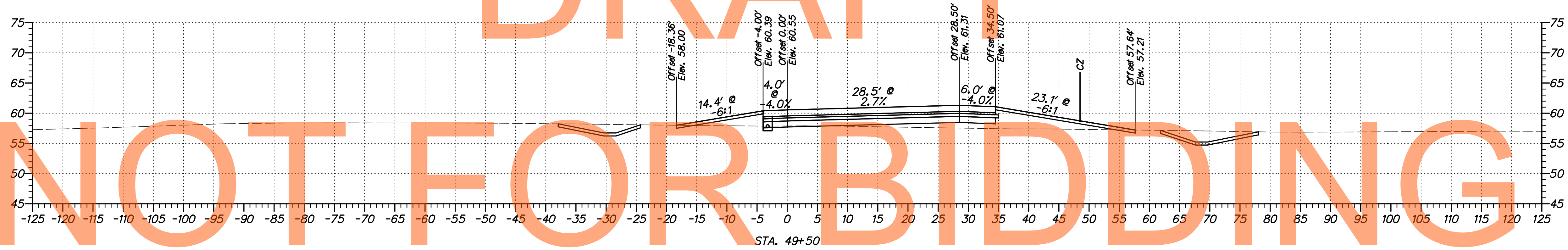
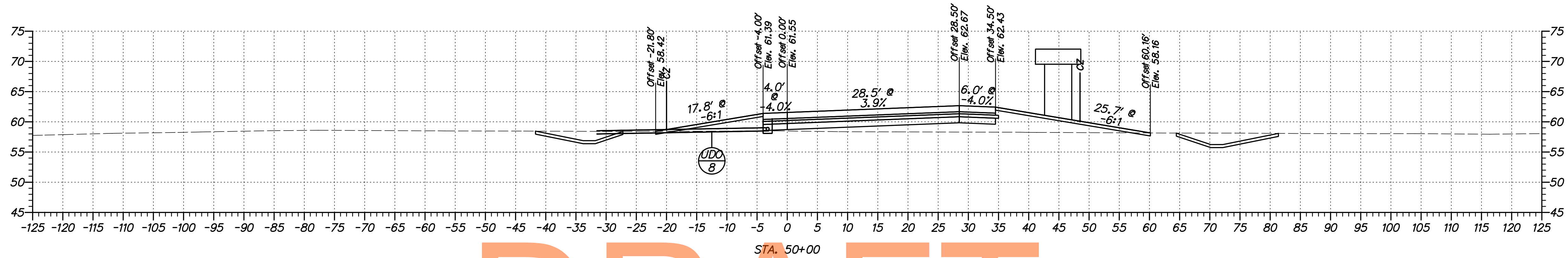

DRAFT
NOT FOR BIDDING
AUGUST 2015

G:\60049040 US301\CIVIL\PLANS\2A\YSEC\X.S.-F07_2A.DGN



ADDENDUMS / REVISIONS

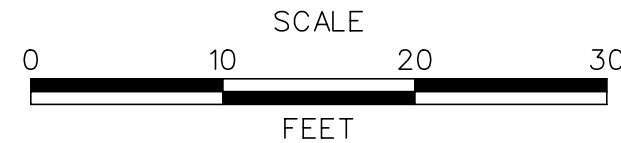

**US 301
LEVELS ROAD
TO SUMMIT BRIDGE ROAD**

CONTRACT	BRIDGE NO.
T20091303	
COUNTY	DESIGNED BY: SS
NEW CASTLE	CHECKED BY: AM

**CROSS SECTIONS
US 301 RAMP F
STA. 49+00 - 50+00**

SHEET NO.
327
TOTAL SHTS.
518

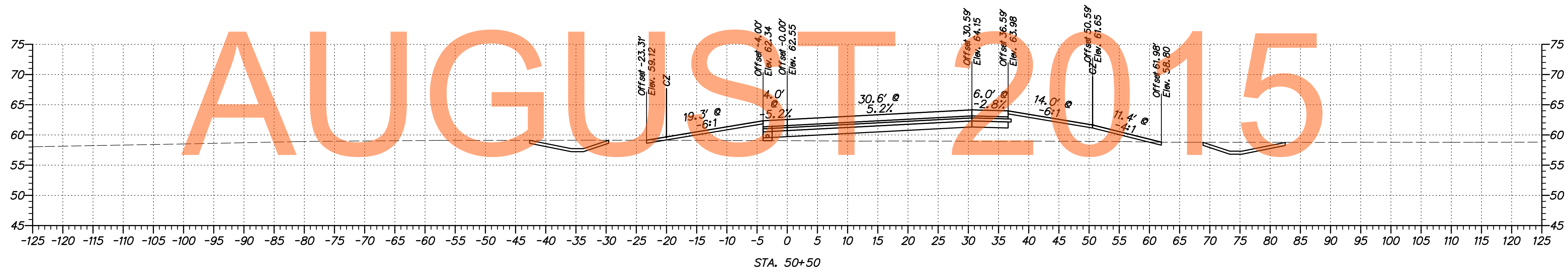
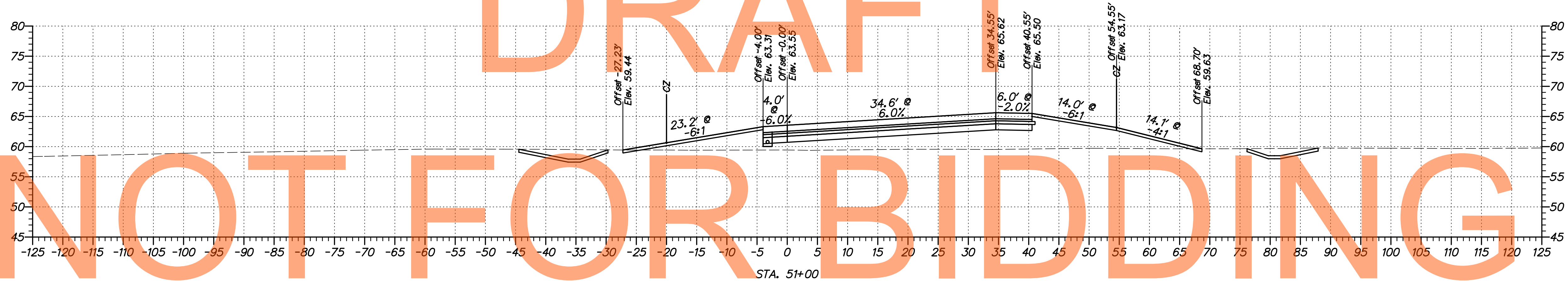
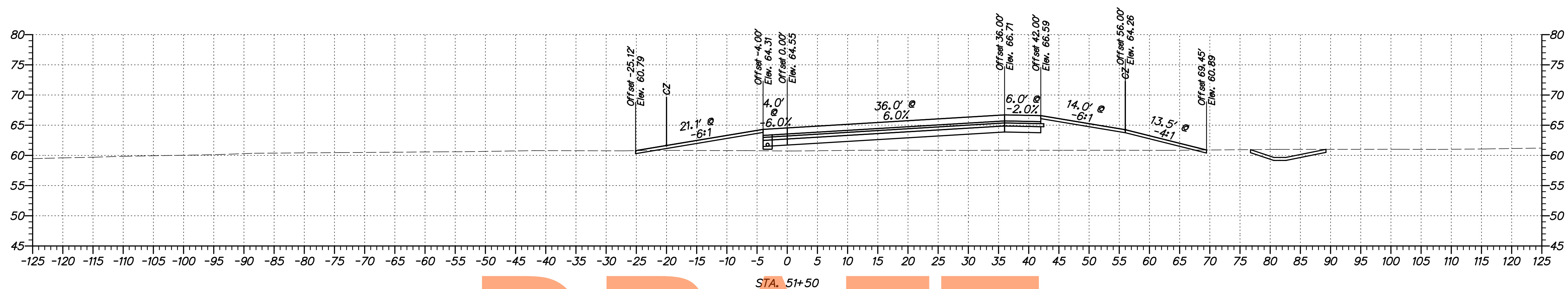

DRAFT
NOT FOR BIDDING
AUGUST 2015

G:\60049040 US301\CIVIL\PLANS\2A\YSEC\XS-F08_2A.DGN



ADDENDUMS / REVISIONS	

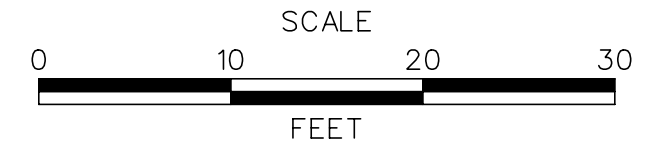

**US 301
LEVELS ROAD
TO SUMMIT BRIDGE ROAD**

CONTRACT	BRIDGE NO.
T20091303	DESIGNED BY: SS
COUNTY	CHECKED BY: AM
NEW CASTLE	

**CROSS SECTIONS
US 301 RAMP F
STA. 50+50 - 51+50**

SHEET NO.
328
TOTAL SHTS.
518

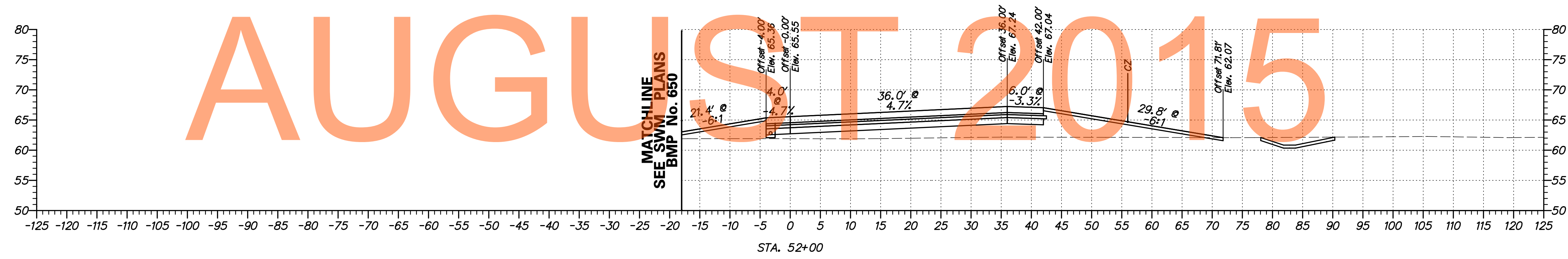
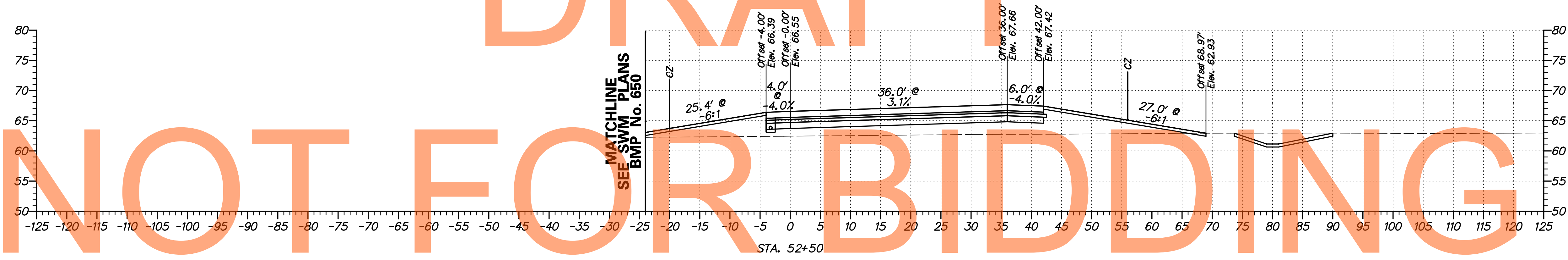
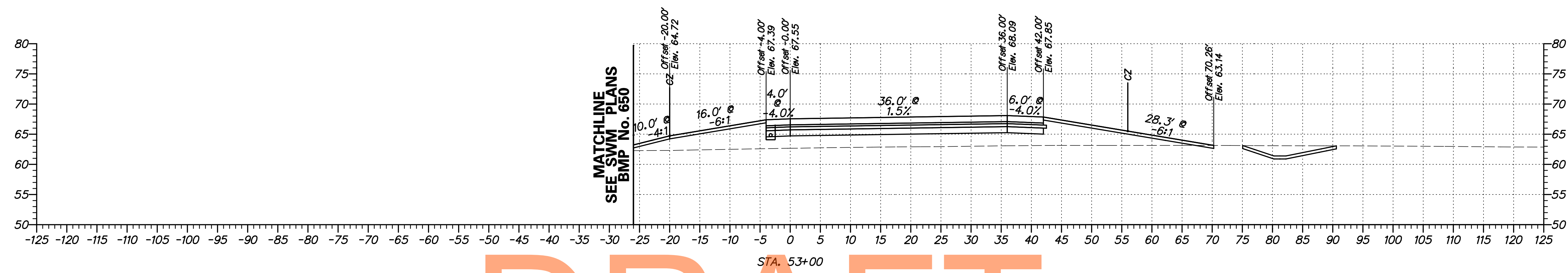

DRAFT
NOT FOR BIDDING
AUGUST 2015

G:\60049040 US301\CIVIL\PLANS\2A\YSEC\XS-F08_2A.DGN

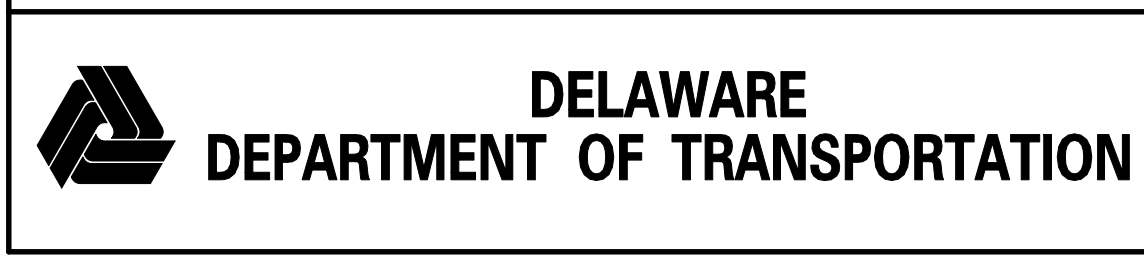

ADDENDUMS / REVISIONS	

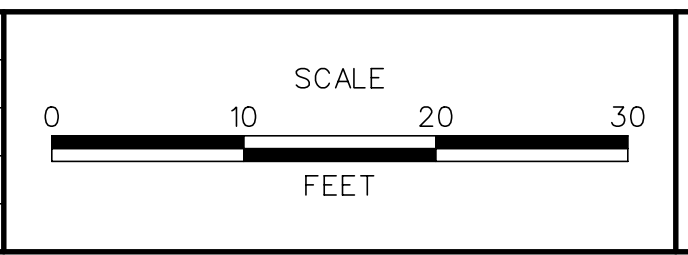

**US 301
LEVELS ROAD
TO SUMMIT BRIDGE ROAD**

CONTRACT	BRIDGE NO.
T20091303	
COUNTY	DESIGNED BY: SS
NEW CASTLE	CHECKED BY: AM

**CROSS SECTIONS
US 301 RAMP F
STA. 52+00 - 53+00**

SHEET NO.
329
TOTAL SHTS.
518

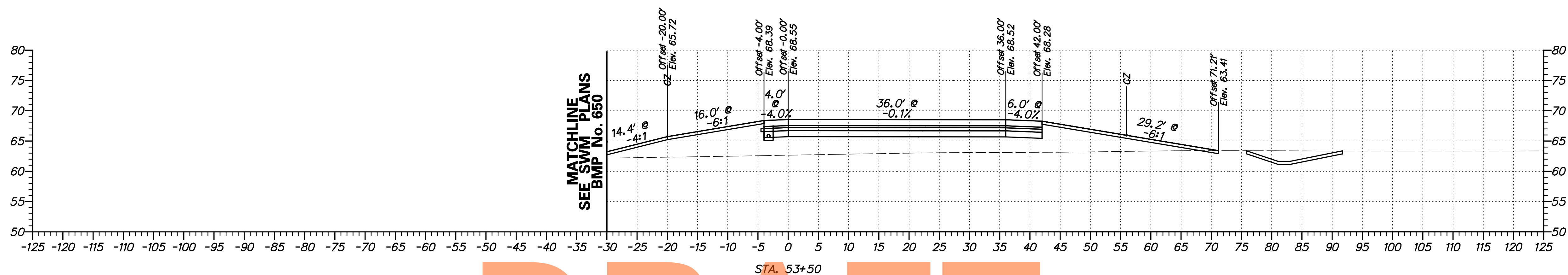

DRAFT

NOT FOR BIDDING

AUGUST 2015

G:\60049040 US301\CIVIL\PLANS\2A\YSEC\XS_F10_2A.DGN

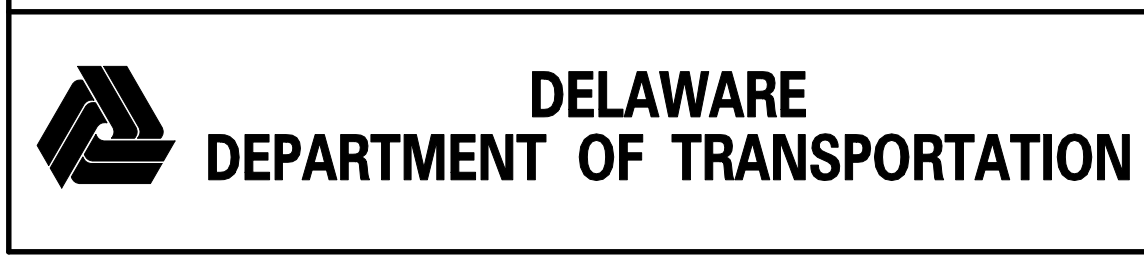

ADDENDUMS / REVISIONS	

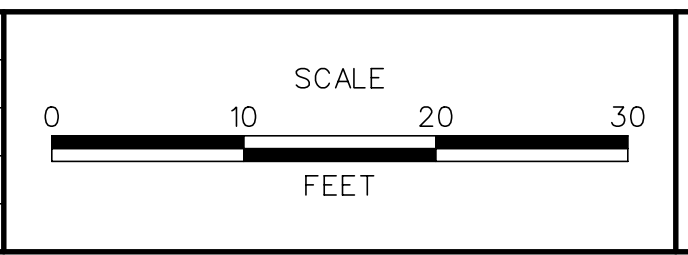

**US 301
LEVELS ROAD
TO SUMMIT BRIDGE ROAD**

CONTRACT	BRIDGE NO.
T20091303	
COUNTY	DESIGNED BY: SS
NEW CASTLE	CHECKED BY: AM

**CROSS SECTIONS
US 301 RAMP F
STA. 53 + 50**

SHEET NO.
330
TOTAL SHTS.
518

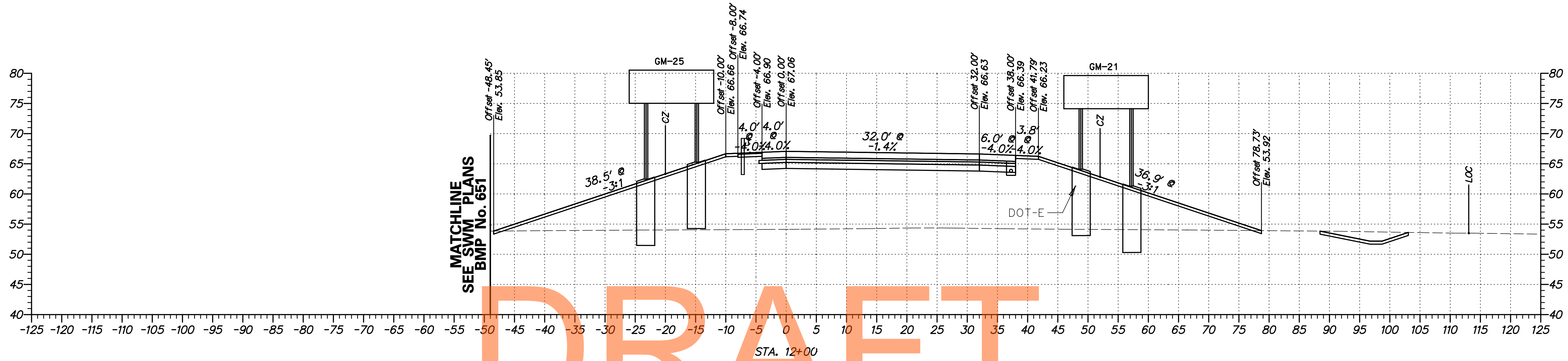

NOT FOR BIDDING

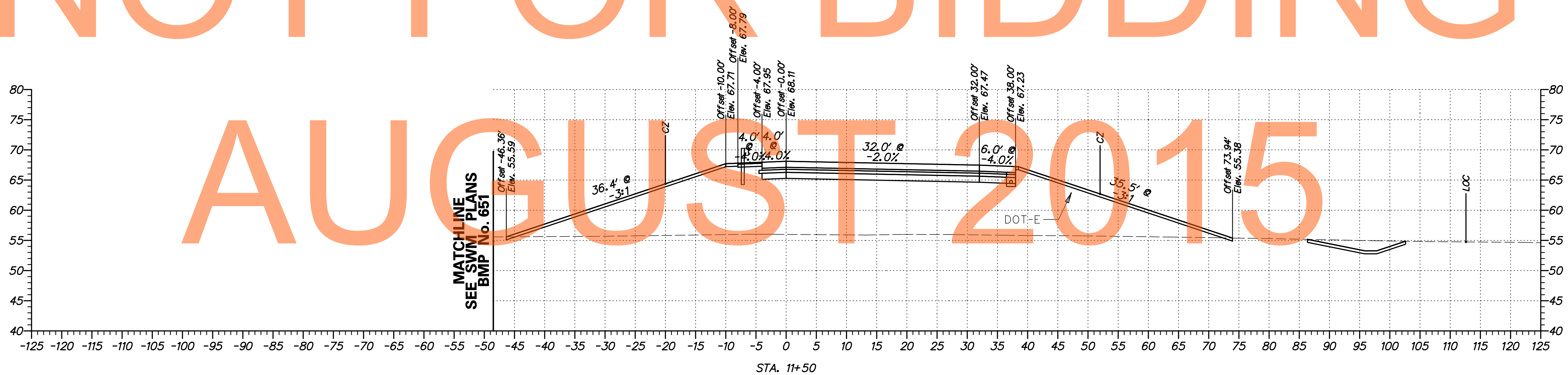

G:\60049040 US301\CIVIL\PLANS\2A\YSEC\XS-C01-2A.DGN



ADDENDUMS / REVISIONS	

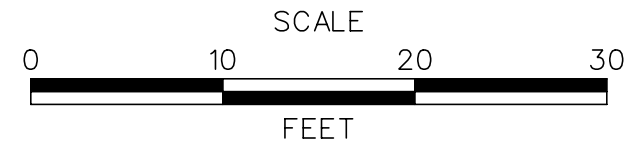

**US 301
LEVELS ROAD
TO SUMMIT BRIDGE ROAD**

CONTRACT	BRIDGE NO.
T20091303	DESIGNED BY: SS
COUNTY	CHECKED BY: AM
NEW CASTLE	

**CROSS SECTIONS
US 301 RAMP C
STA. 11+50 - 12+00**

SHEET NO.
331
TOTAL SHTS.
518

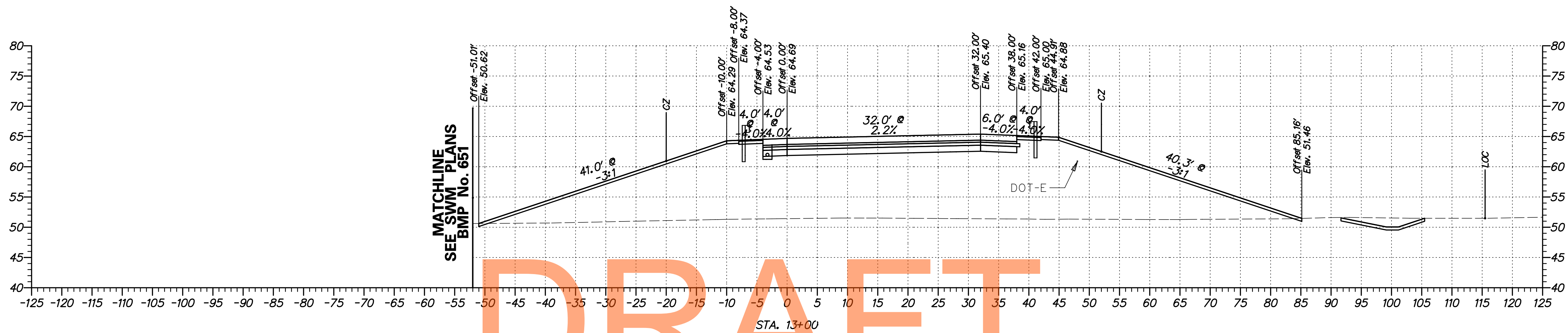

DRAFT

NOT FOR BIDDING

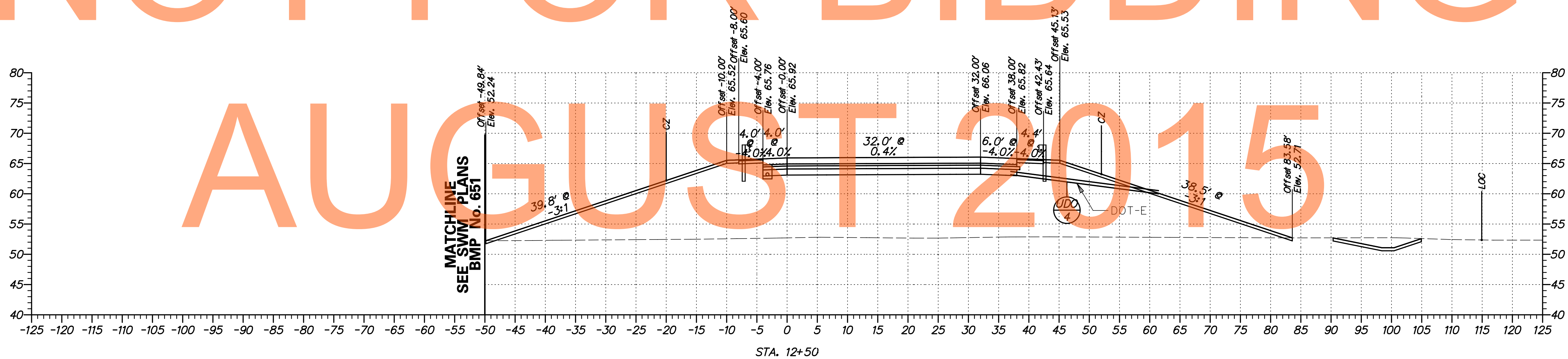

AUGUST 2015

G:\60049040 US301\CIVIL\PLANS\2A\XSEC\XS-C02_2A.DGN



ADDENDUMS / REVISIONS

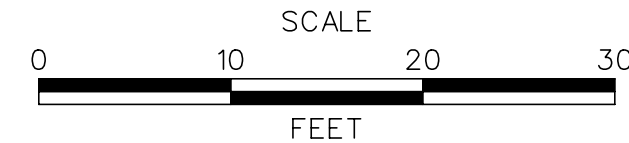

US 301
LEVELS ROAD
TO SUMMIT BRIDGE ROAD

CONTRACT	BRIDGE NO.
T20091303	
COUNTY	DESIGNED BY: SS
NEW CASTLE	CHECKED BY: AM

CROSS SECTIONS
US 301 RAMP C
STA. 12+50 - 13+00

SHEET NO.
332
TOTAL SHTS.
518

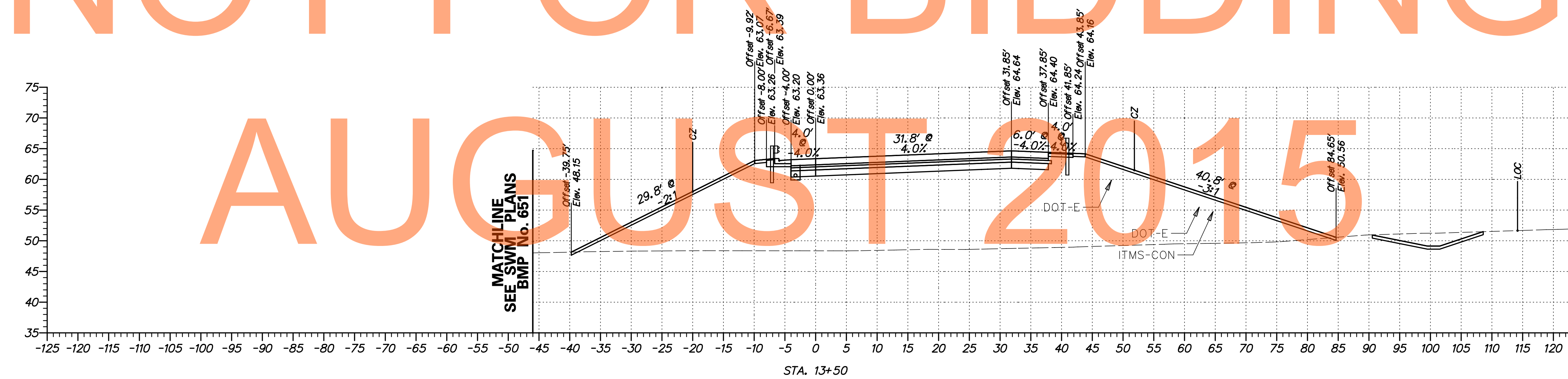
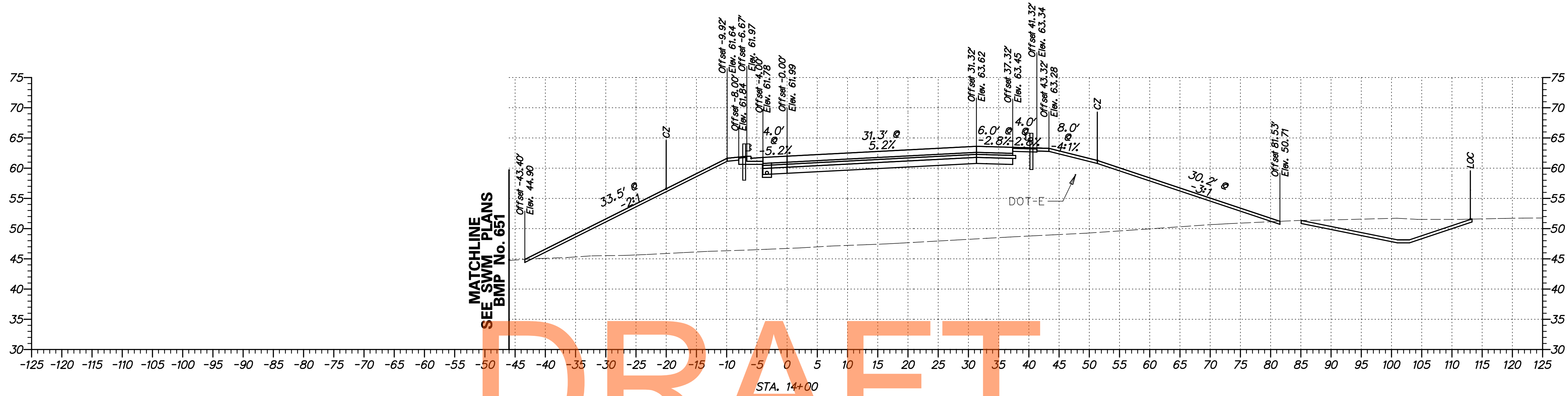

DRAFT

NOT FOR BIDDING

AUGUST 2015

G:\60049040 US301\CIVIL\PLANS\2A\YSEC\XS-C03_2A.DGN

	ADDENDUMS / REVISIONS		SCALE 0 10 20 30 FEET	US 301 LEVELS ROAD TO SUMMIT BRIDGE ROAD	CONTRACT T200911303	BRIDGE NO.	CROSS SECTIONS US 301 RAMP C STA. 13+50 - 14+00	SHEET NO. 333
	DELAWARE DEPARTMENT OF TRANSPORTATION	COUNTY NEW CASTLE			DESIGNED BY: SS CHECKED BY: AM	TOTAL SHTS. 518		

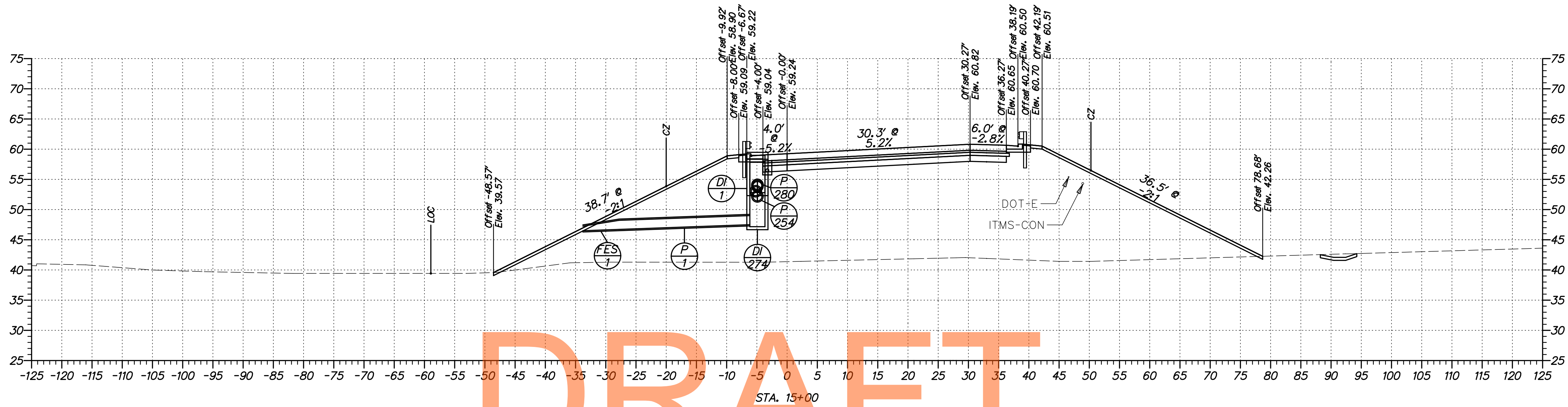

DRAFT

NOT FOR BIDDING

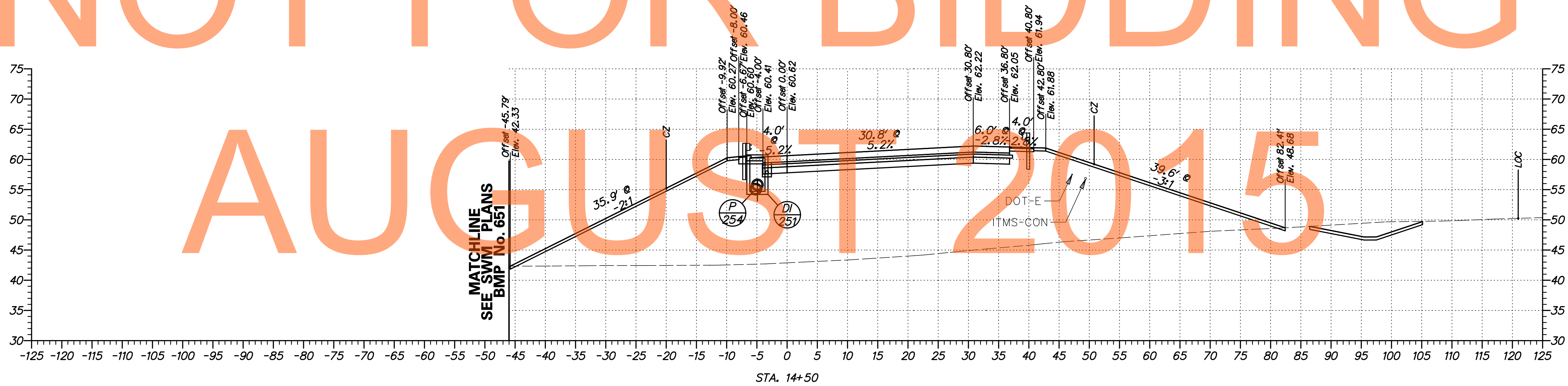

AUGUST 2015

G:\60049040 US301\CIVIL\PLANS\2A\YSEC\XS_C04_2A.DGN

DELAWARE DEPARTMENT OF TRANSPORTATION	ADDENDUMS / REVISIONS	SCALE FEET	US 301 LEVELS ROAD TO SUMMIT BRIDGE ROAD	CONTRACT T200911303	BRIDGE NO.	CROSS SECTIONS US 301 RAMP C STA. 14+50 - 15+00	SHEET NO. 334
					COUNTY NEW CASTLE		DESIGNED BY: SS

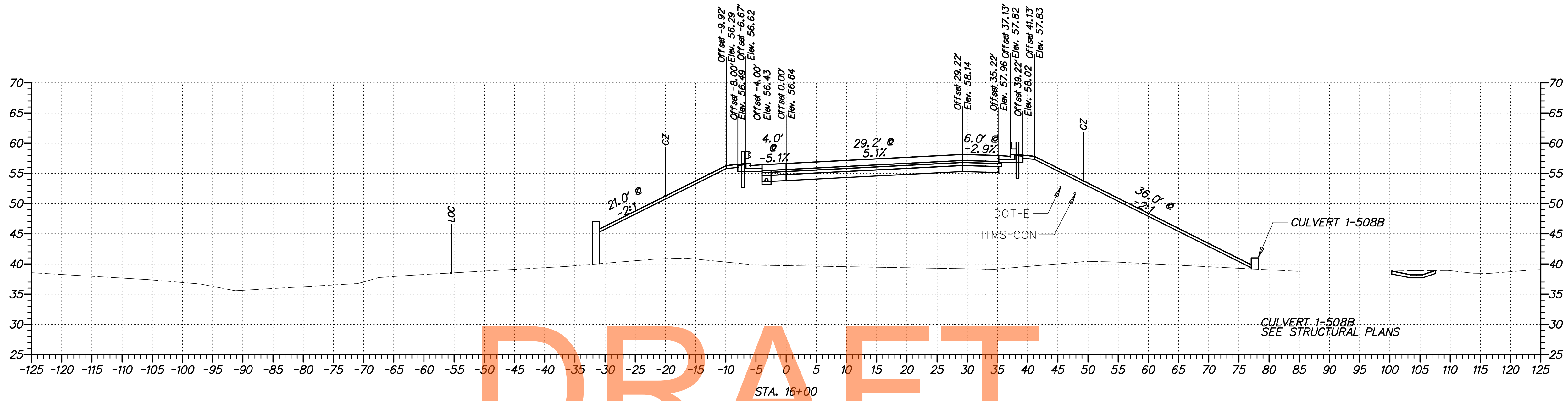

DRAFT

NOT FOR BIDDING

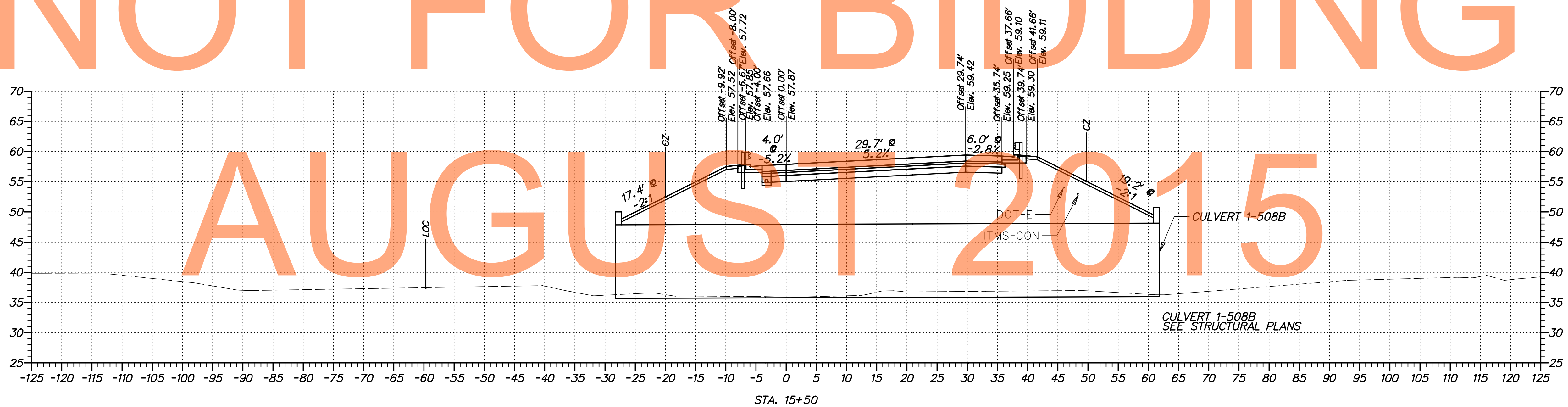

AUGUST 2015

G:\60049040 US301\CIVIL\PLANS\2A\XSEC\XS_C05_2A.DGN

DELAWARE DEPARTMENT OF TRANSPORTATION	ADDENDUMS / REVISIONS	SCALE 	US 301 LEVELS ROAD TO SUMMIT BRIDGE ROAD	CONTRACT T20091303	BRIDGE NO.	CROSS SECTIONS US 301 RAMP C STA. 15+50 - 16+00	SHEET NO. 335
					COUNTY NEW CASTLE		DESIGNED BY: SS

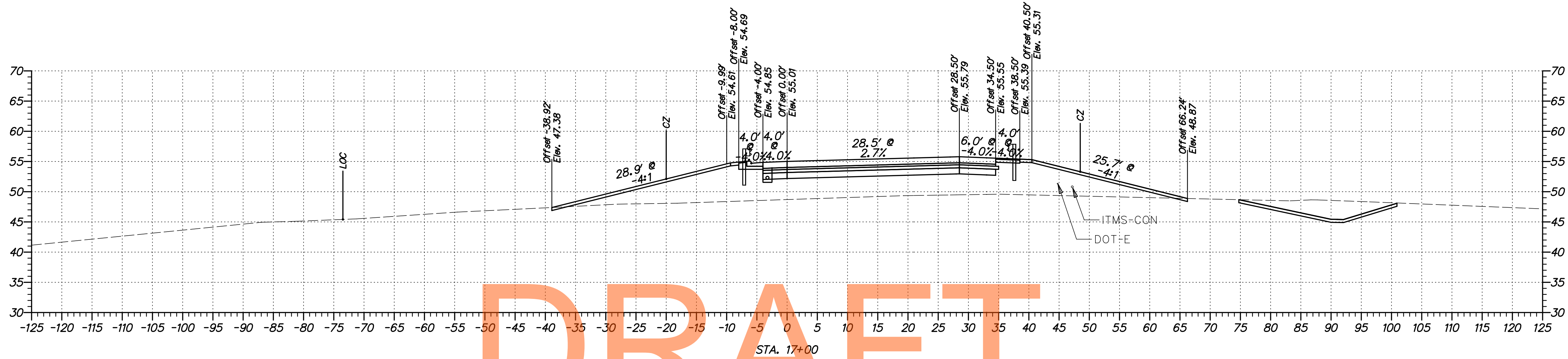

DRAFT

NOT FOR BIDDING

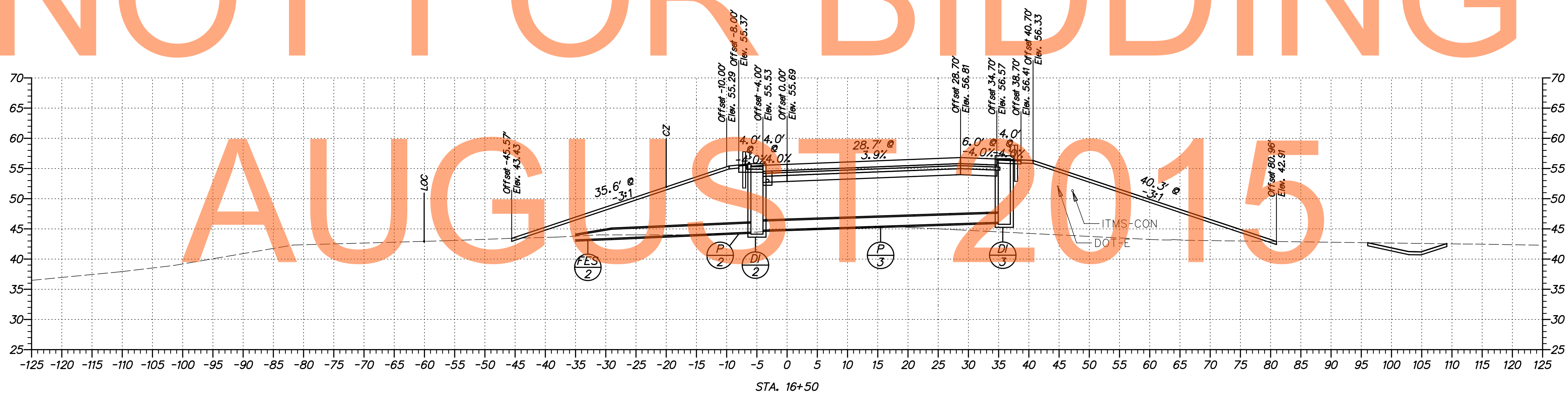

AUGUST 2015

G:\60049040 US301\CIVIL\PLANS\2A\YSEC\XS_C06_2A.DGN

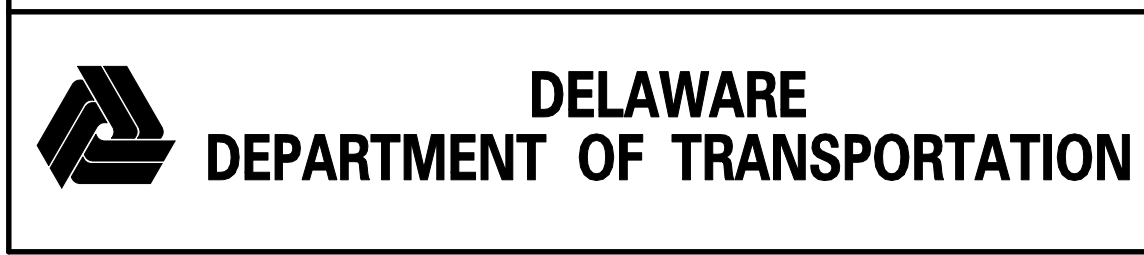

ADDENDUMS / REVISIONS	

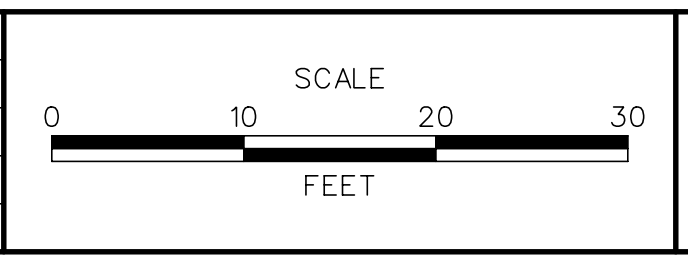

**US 301
LEVELS ROAD
TO SUMMIT BRIDGE ROAD**

CONTRACT T20091303	BRIDGE NO.
COUNTY NEW CASTLE	DESIGNED BY: SS
	CHECKED BY: AM

**CROSS SECTIONS
US 301 RAMP C
STA. 16+50 - 17+00**

SHEET NO. 336
TOTAL SHTS. 518

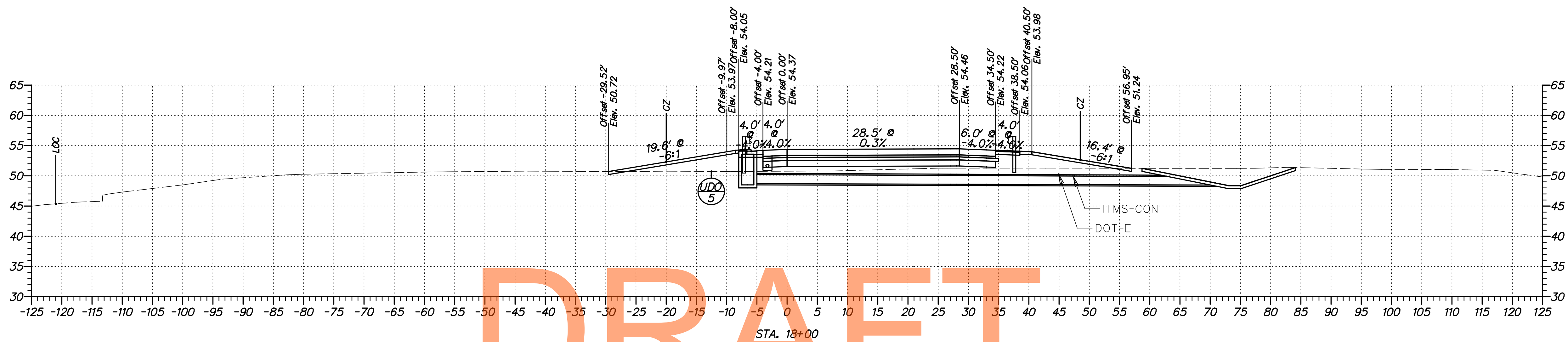

DRAFT

NOT FOR BIDDING

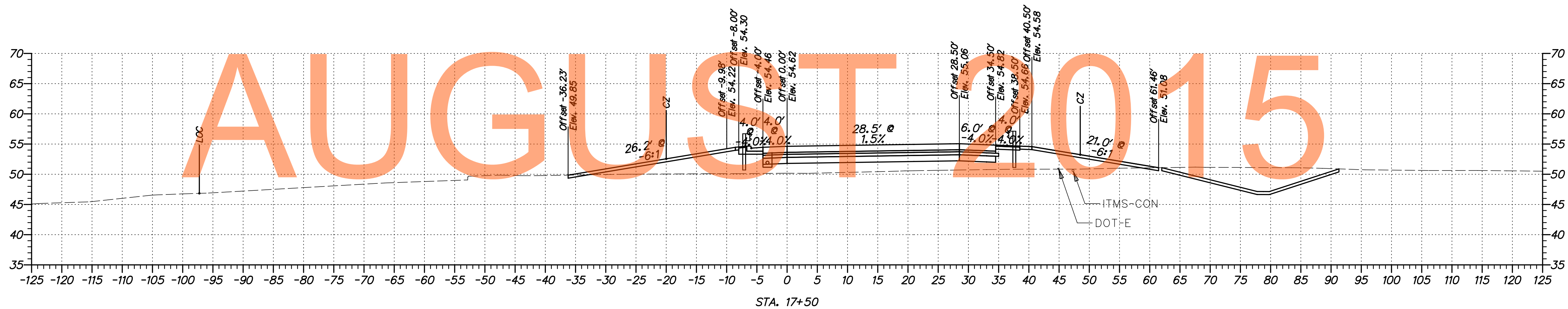

AUGUST 2015

G:\60049040 US301\CIVIL\PLANS\2A\YSEC\XS-C07_2A.DGN

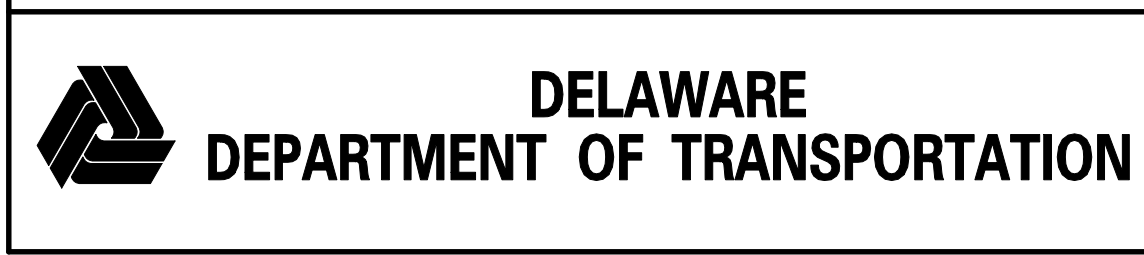

ADDENDUMS / REVISIONS	

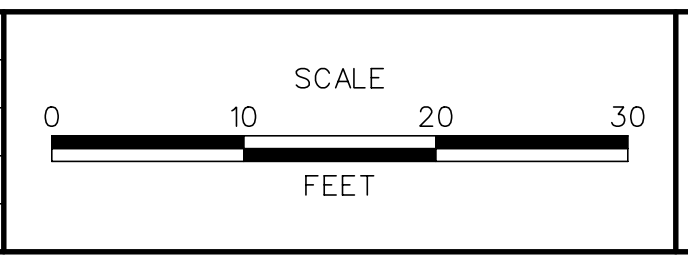

US 301
LEVELS ROAD
TO SUMMIT BRIDGE ROAD

CONTRACT	BRIDGE NO.
T20091303	
COUNTY	DESIGNED BY: SS
NEW CASTLE	CHECKED BY: AM

CROSS SECTIONS
US 301 RAMP C
STA. 17+50 - 18+00

SHEET NO.
337
TOTAL SHTS.
518

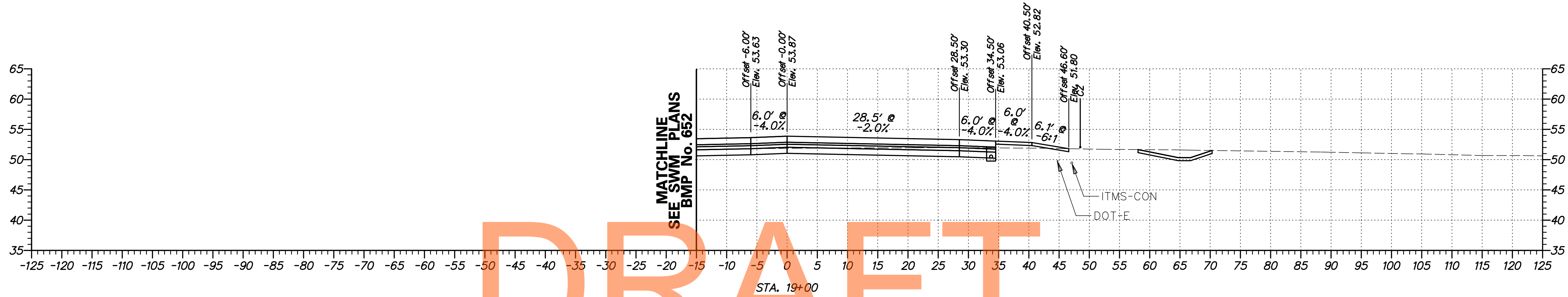

NOT FOR BIDDING

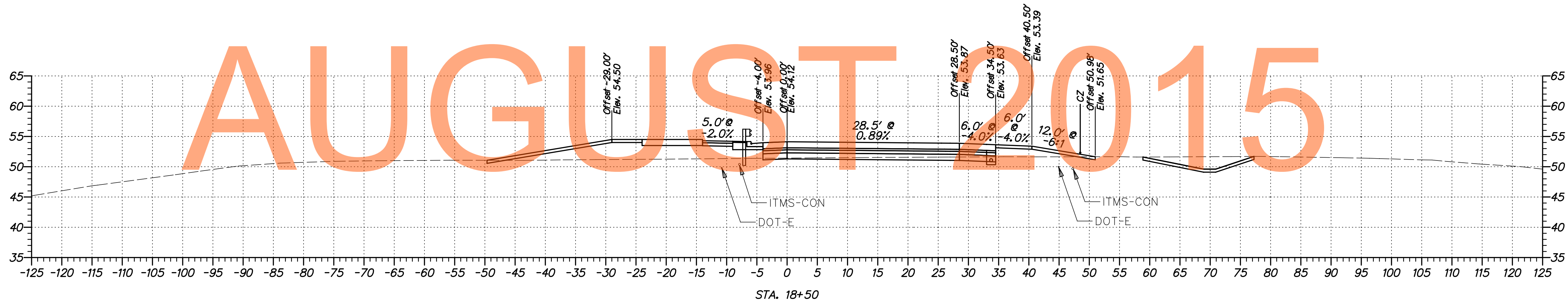

G:\60049040 US301\CIVIL\PLANS\2A\YSEC\XS_C08_2A.DGN



ADDENDUMS / REVISIONS	

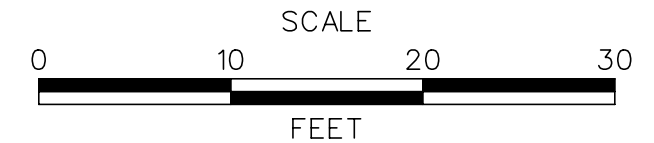

US 301
LEVELS ROAD
TO SUMMIT BRIDGE ROAD

CONTRACT T20091303	BRIDGE NO.
COUNTY NEW CASTLE	DESIGNED BY: SS
	CHECKED BY: AM

CROSS SECTIONS
US 301 RAMP C
STA. 18+50 - 19+00

SHEET NO. 338
TOTAL SHTS. 518

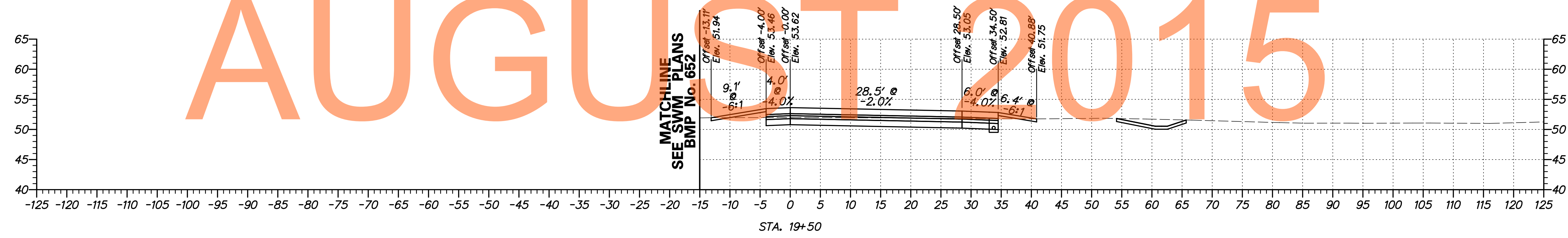
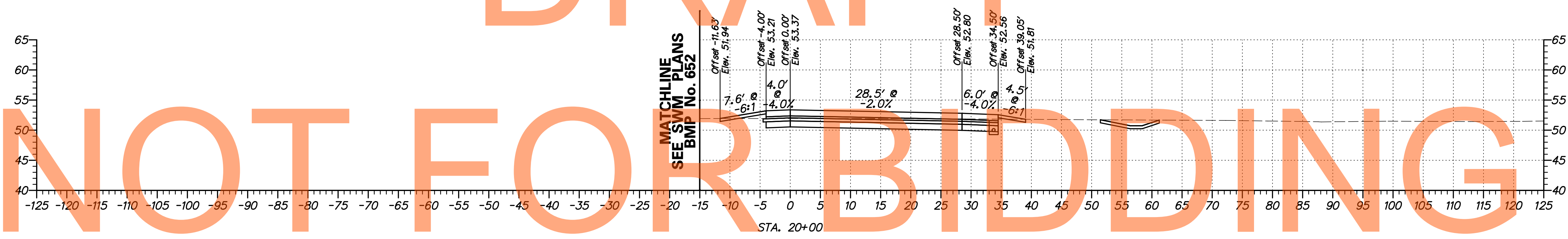
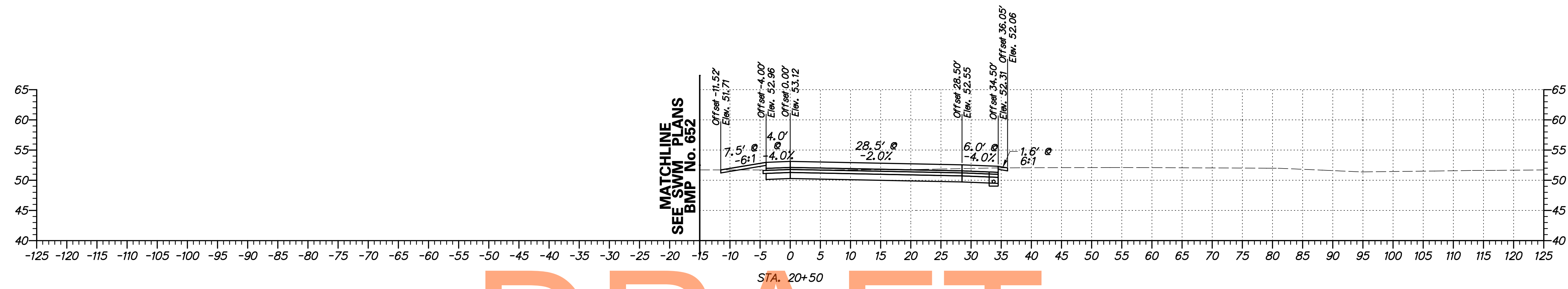

DRAFT
NOT FOR BIDDING
AUGUST 2015

G:\60049040 US301\CIVIL\PLANS\2A\YSEC\XS_C08_2A.DGN

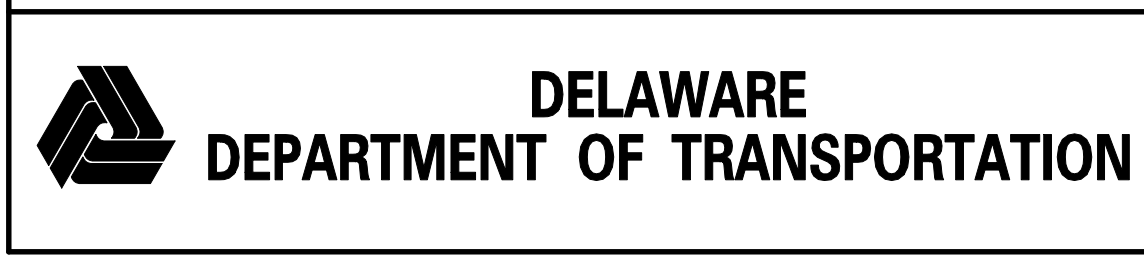

ADDENDUMS / REVISIONS	

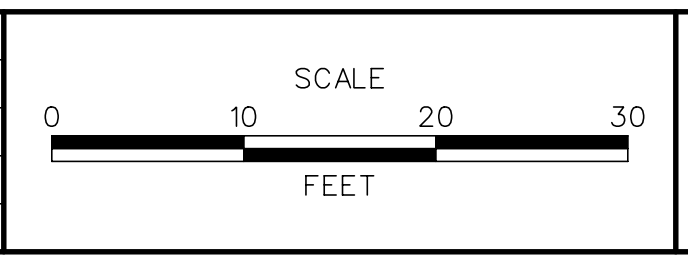

**US 301
LEVELS ROAD
TO SUMMIT BRIDGE ROAD**

CONTRACT	BRIDGE NO.
T20091303	
COUNTY	DESIGNED BY: SS
NEW CASTLE	CHECKED BY: AM

**CROSS SECTIONS
US 301 RAMP C
STA. 19+50 - 20+50**

SHEET NO.
339
TOTAL SHTS.
518

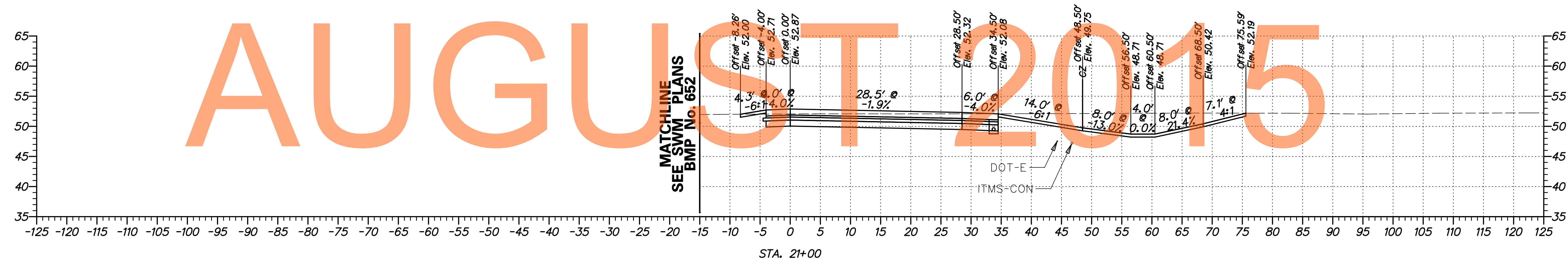
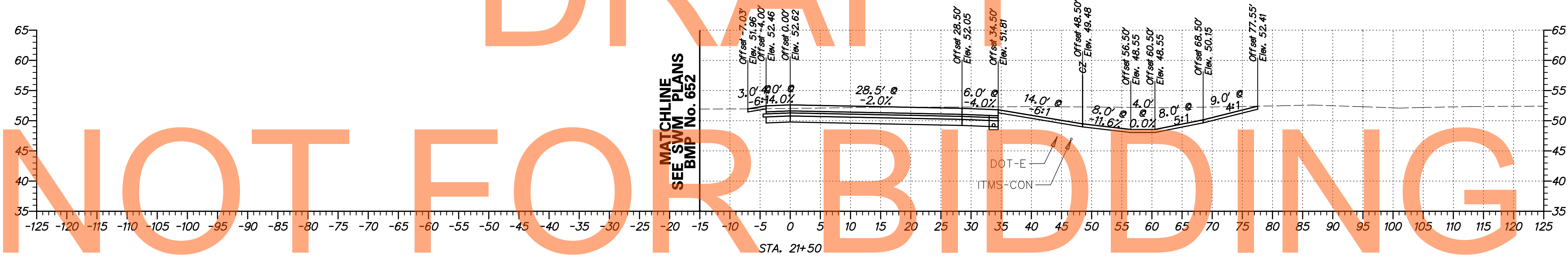
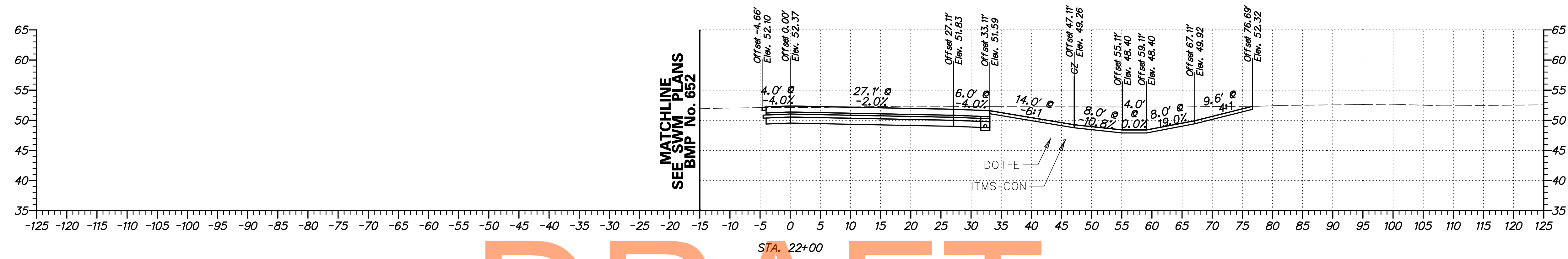

DRAFT
NOT FOR BIDDING
AUGUST 2015

G:\60049040 US301\CIVIL\PLANS\21A\YSEC\XS_C10_2A.DGN

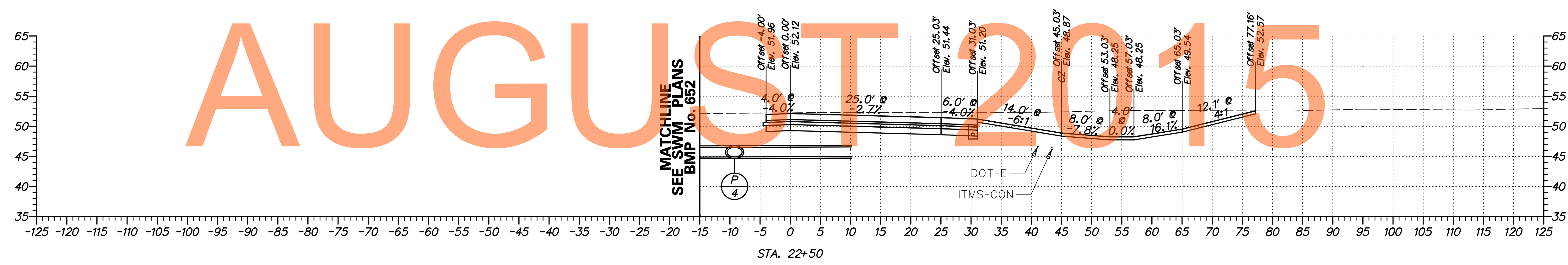
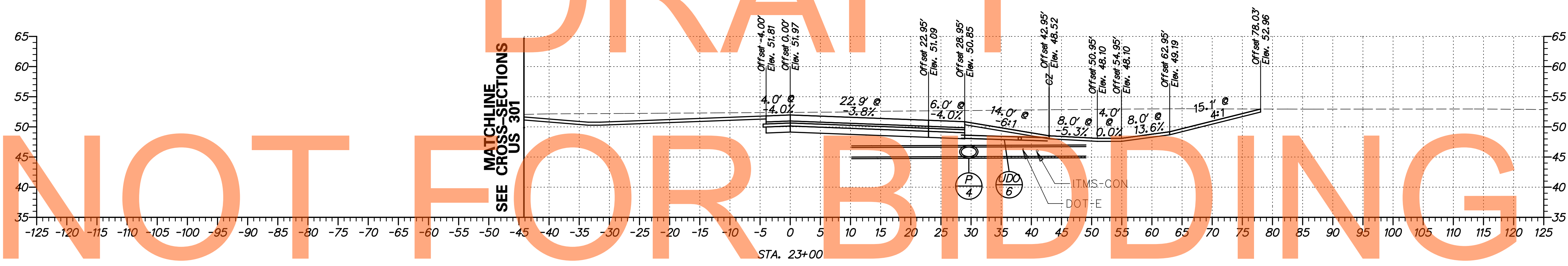
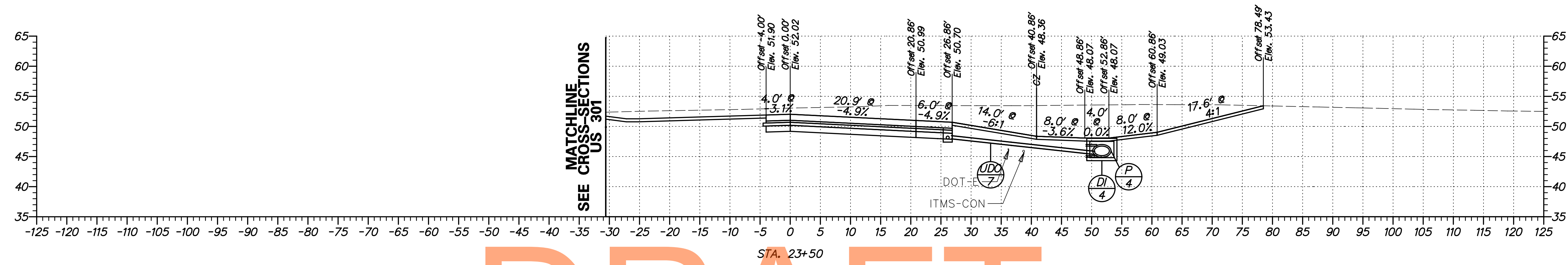

DRAFT
NOT FOR BIDDING
AUGUST 2015

G:\60049040 US301\CIVIL\PLANS\2A\YSEC\XS_C11_2A.DGN

DELAWARE DEPARTMENT OF TRANSPORTATION	ADDENDUMS / REVISIONS	SCALE FEET	US 301 LEVELS ROAD TO SUMMIT BRIDGE ROAD	CONTRACT T200911303	BRIDGE NO.	CROSS SECTIONS US 301 RAMP C STA. 22+50 - 23+50	SHEET NO. 341
					COUNTY NEW CASTLE		DESIGNED BY: SS

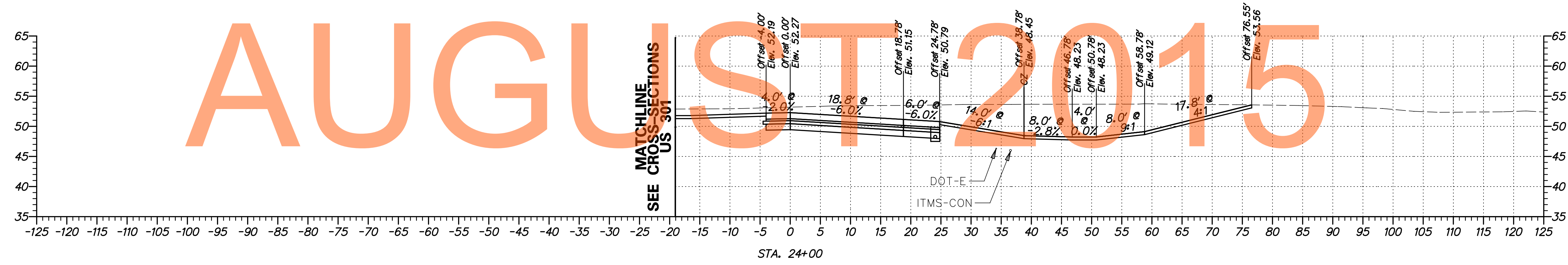
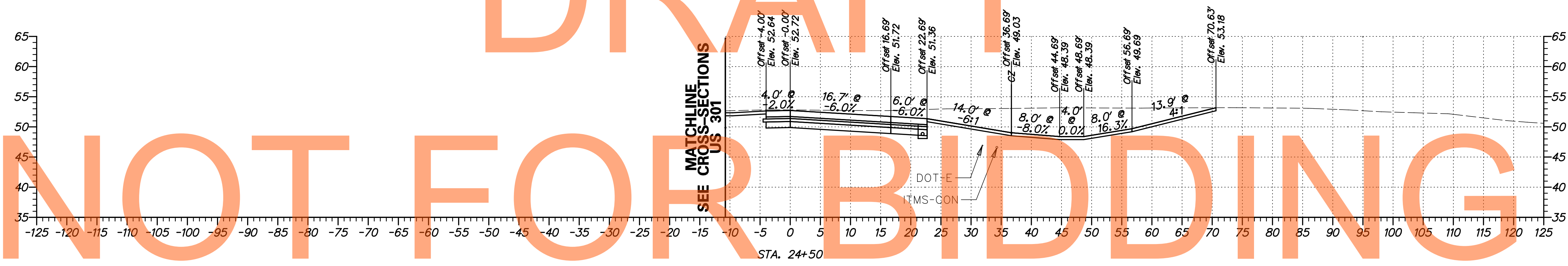
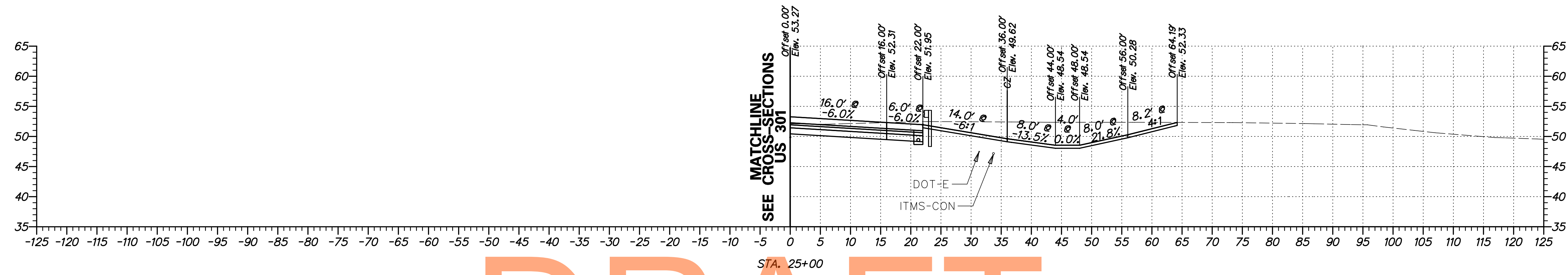

DRAFT
NOT FOR BIDDING
AUGUST 2015

G:\60049040 US301\CIVIL\PLANS\2A\YSEC\XS-C12-2A.DGN

DELAWARE DEPARTMENT OF TRANSPORTATION	ADDENDUMS / REVISIONS	SCALE FEET	US 301 LEVELS ROAD TO SUMMIT BRIDGE ROAD	CONTRACT T200911303	BRIDGE NO.	CROSS SECTIONS US 301 RAMP C STA. 24+00 - 25+00	SHEET NO. 342
					COUNTY NEW CASTLE		DESIGNED BY: SS

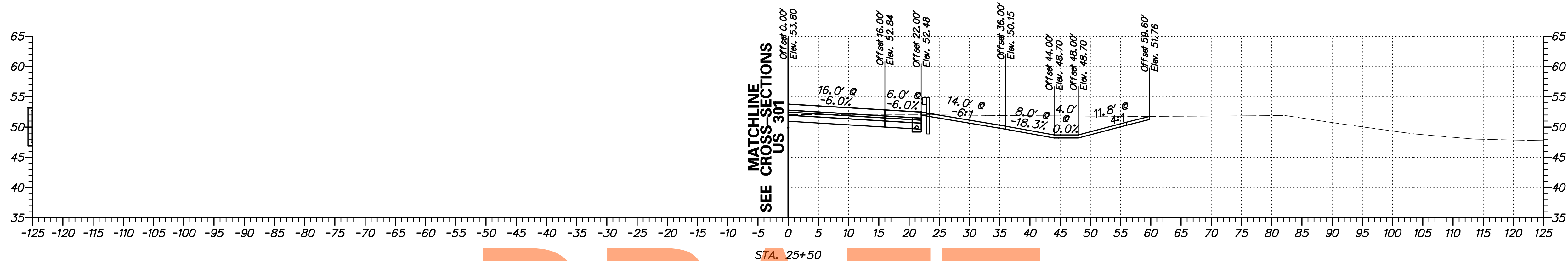

DRAFT

NOT FOR BIDDING

AUGUST 2015

G:\60049040 US301\CIVIL\PLANS\2A\YSEC\XS-C13-2A.DGN



DELAWARE
DEPARTMENT OF TRANSPORTATION

ADDENDUMS / REVISIONS

NO.	DATE	DESCRIPTION



US 301
LEVELS ROAD
TO SUMMIT BRIDGE ROAD

CONTRACT	BRIDGE NO.
T20091303	
COUNTY	DESIGNED BY: SS
NEW CASTLE	CHECKED BY: AM

CROSS SECTIONS
US 301 RAMP C
STA. 25 + 50

SHEET NO.
343
TOTAL SHTS.
518

S:\PROJECTS\TRANSPORTATION\JOBS-NR\NEW CASTLE\301\ROAD\T20091303\PLANS\REFS\CPBOARD XS-2A.URS.DGN

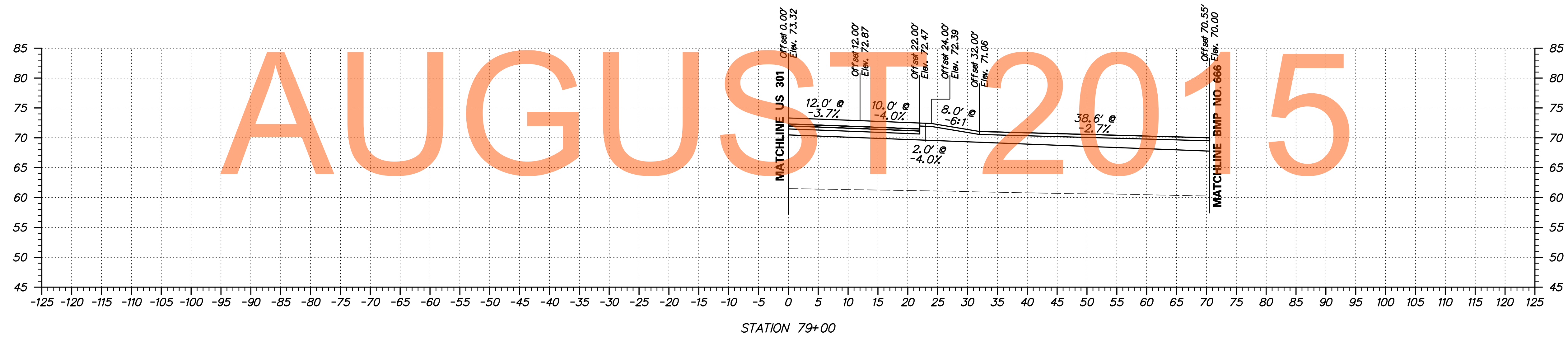
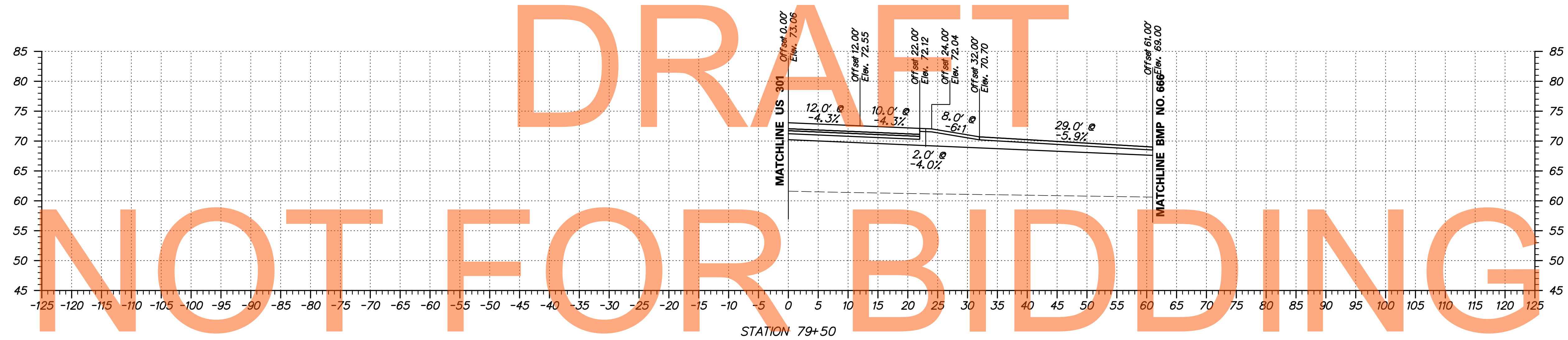

ADDENDUMS / REVISIONS

NO.	DATE	DESCRIPTION

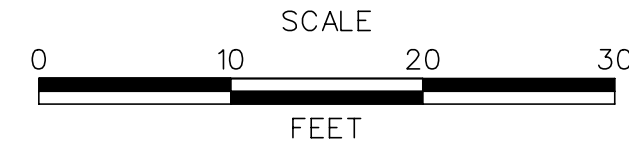

**US 301
LEVELS ROAD
TO SUMMIT BRIDGE ROAD**

CONTRACT	BRIDGE NO.	
T20091303	DESIGNED BY:	IK
COUNTY	CHECKED BY:	JH
NEW CASTLE		

**RAMP G
CROSS SECTIONS**

SHEET NO.	344
TOTAL SHTS.	518

S:\PROJECTS\TRANSPORTATION\JOBS-NR\NEW CASTLE\30N\ROAD\T20091303\PLANS\XREFS\CPBOARD XS_2A_URS.DGN

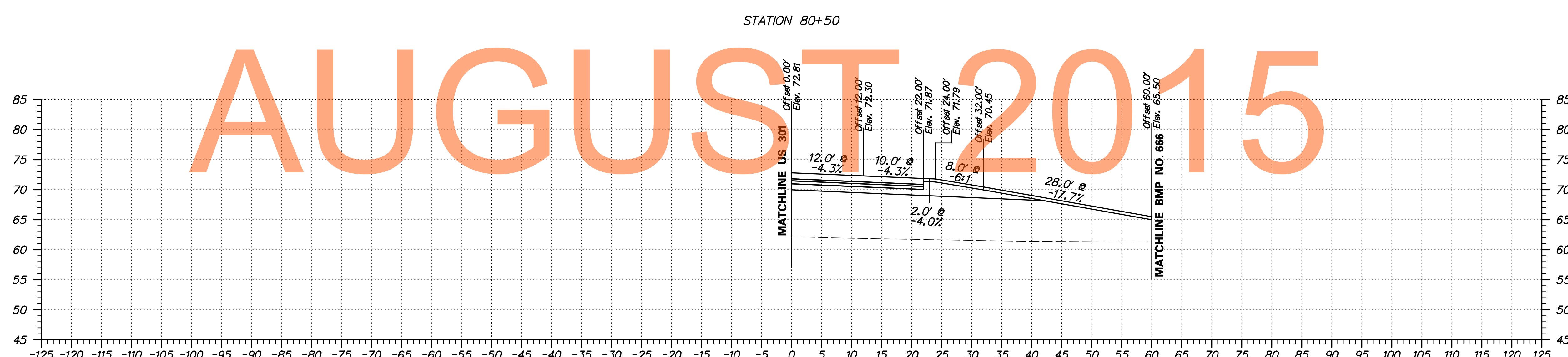
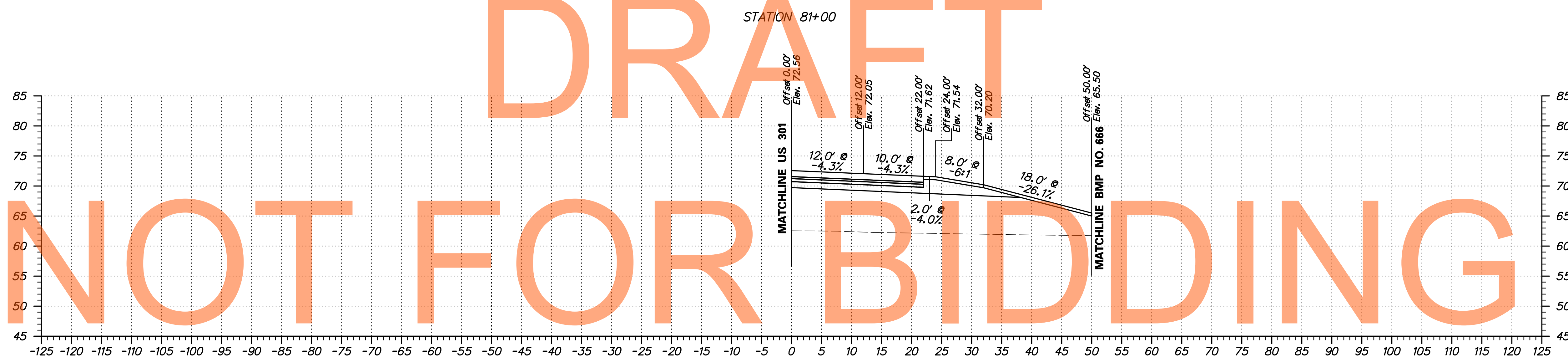
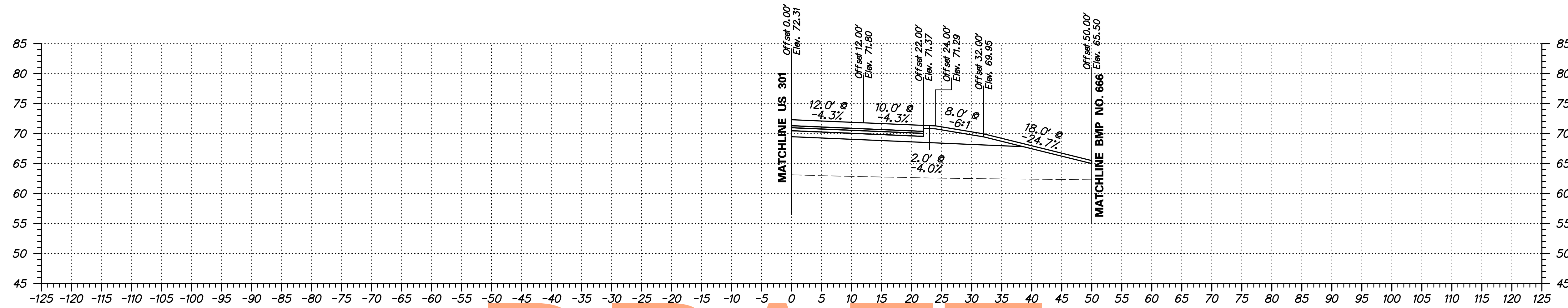

STATION 80+00

DRAFT

NOT FOR BIDDING

AUGUST 2015



ADDENDUMS / REVISIONS	

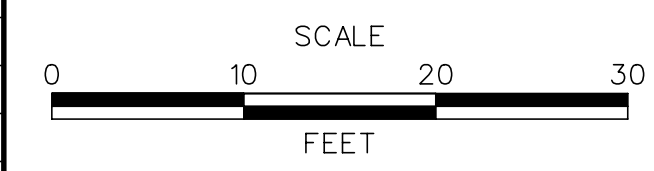

**US 301
LEVELS ROAD
TO SUMMIT BRIDGE ROAD**

CONTRACT	BRIDGE NO.	
T20091303	DESIGNED BY:	IK
COUNTY	CHECKED BY:	JH
NEW CASTLE		

**RAMP G
CROSS SECTIONS**

SHEET NO.	345
TOTAL SHTS.	518

S:\PROJECTS\TRANSPORTATION\JOBS-NR\NEW CASTLE\30N\ROAD\T20091303\PLANS\XREFS\CPBOARD XS-2A.URS.DGN

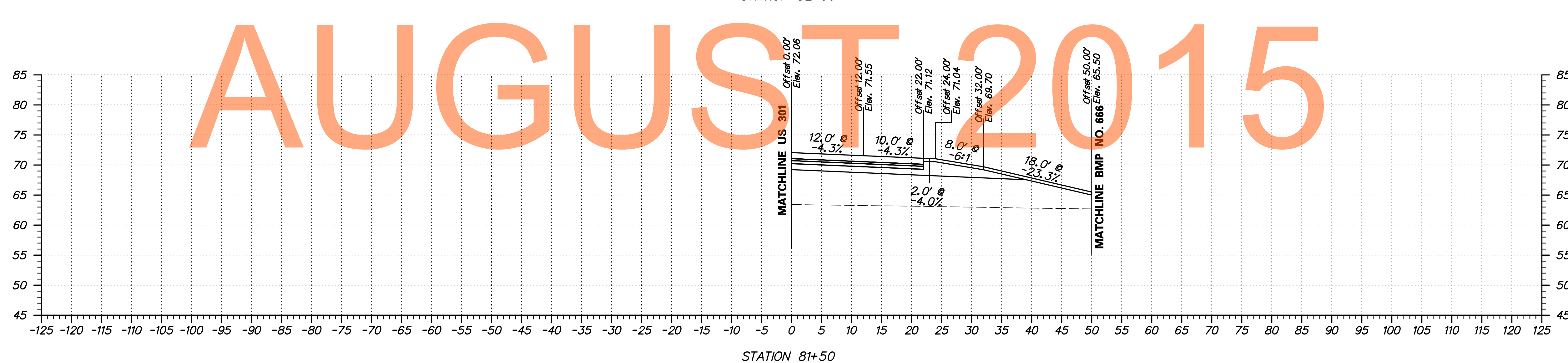
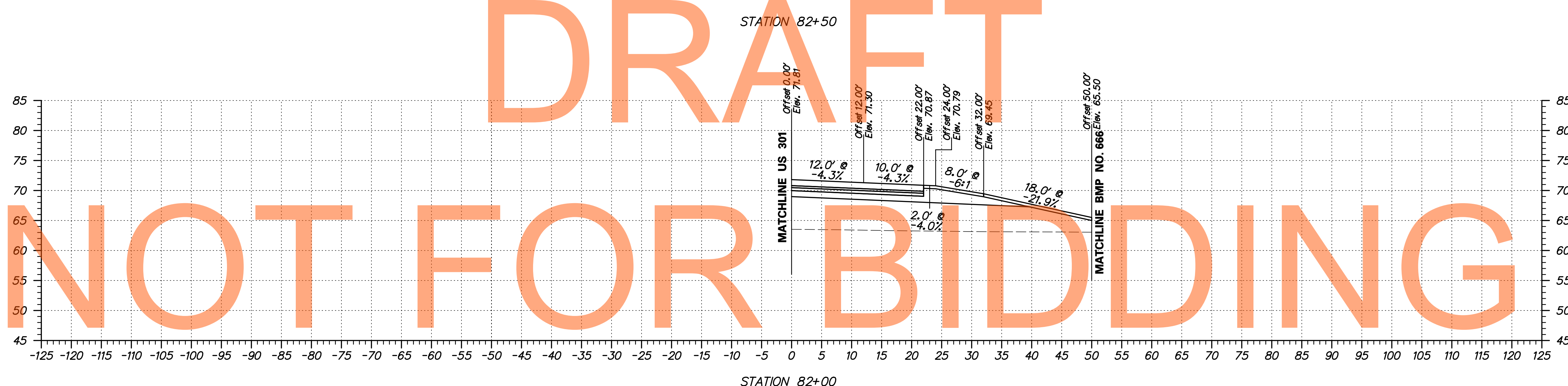
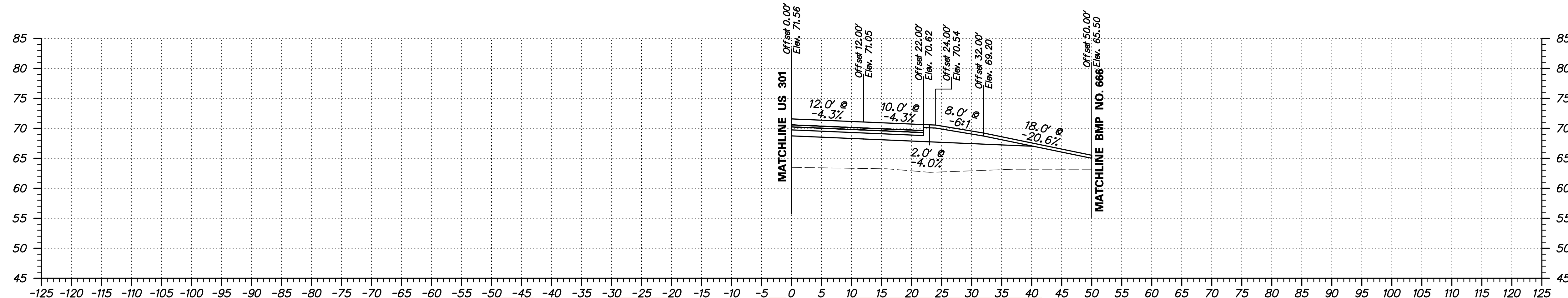

DRAFT

NOT FOR BIDDING

AUGUST 2015



ADDENDUMS / REVISIONS

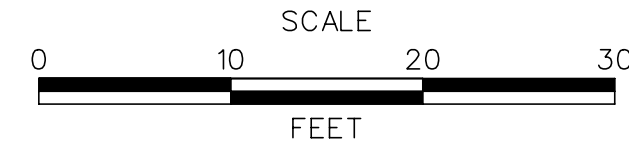

**US 301
 LEVELS ROAD
 TO SUMMIT BRIDGE ROAD**

CONTRACT	BRIDGE NO.	
T20091303	DESIGNED BY:	IK
COUNTY	CHECKED BY:	JH
NEW CASTLE		

**RAMP G
 CROSS SECTIONS**

SHEET NO.	346
TOTAL SHTS.	518

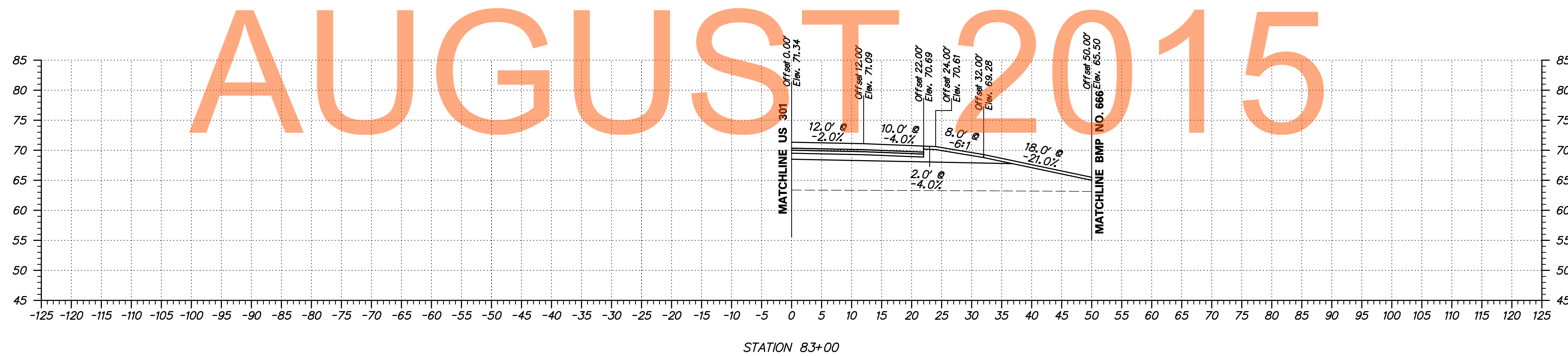
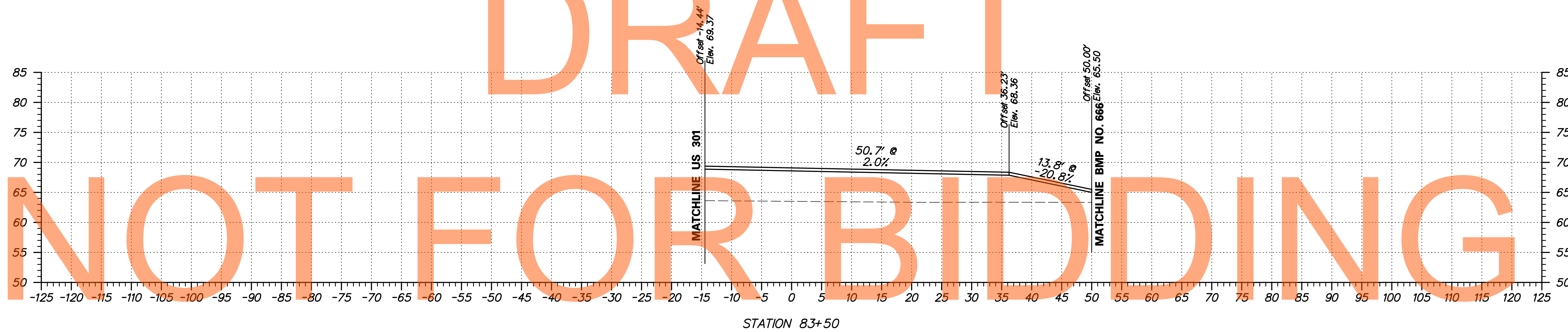
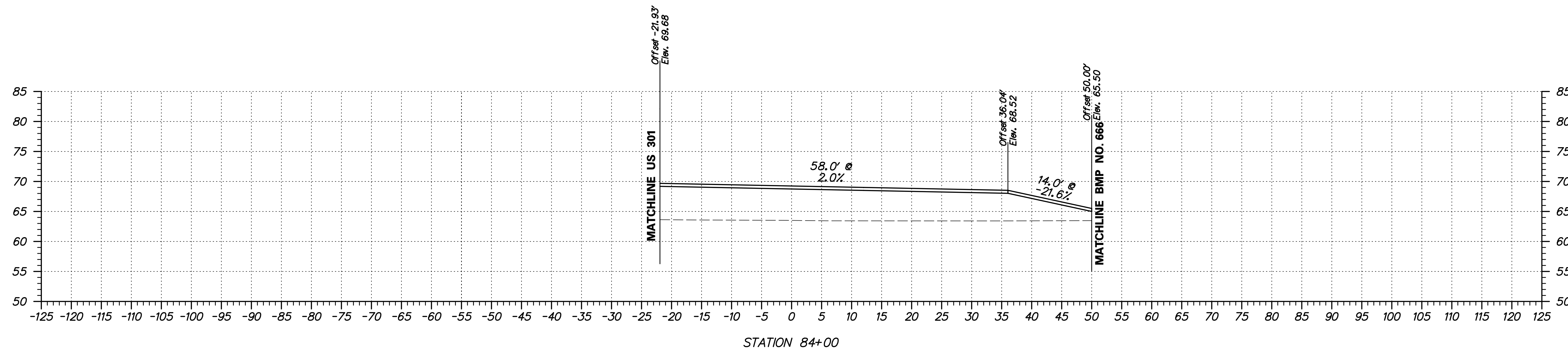

DRAFT
NOT FOR BIDDING
AUGUST 2015

S:\PROJECTS\TRANSPORTATION\JOBS-NR\NEW CASTLE\30N\ROAD\T20091303\PLANS\XREFS\CPBOARD XS-2A.URS.DGN

ADDENDUMS / REVISIONS	

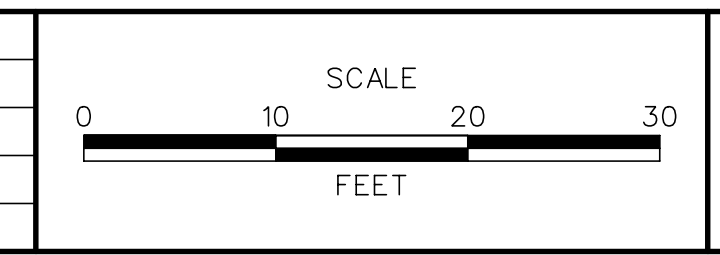

**US 301
LEVELS ROAD
TO SUMMIT BRIDGE ROAD**

CONTRACT	BRIDGE NO.	
T20091303	DESIGNED BY:	IK
COUNTY	CHECKED BY:	JH
NEW CASTLE		

**RAMP G
CROSS SECTIONS**

SHEET NO.
347
TOTAL SHTS.
518

DRAFT

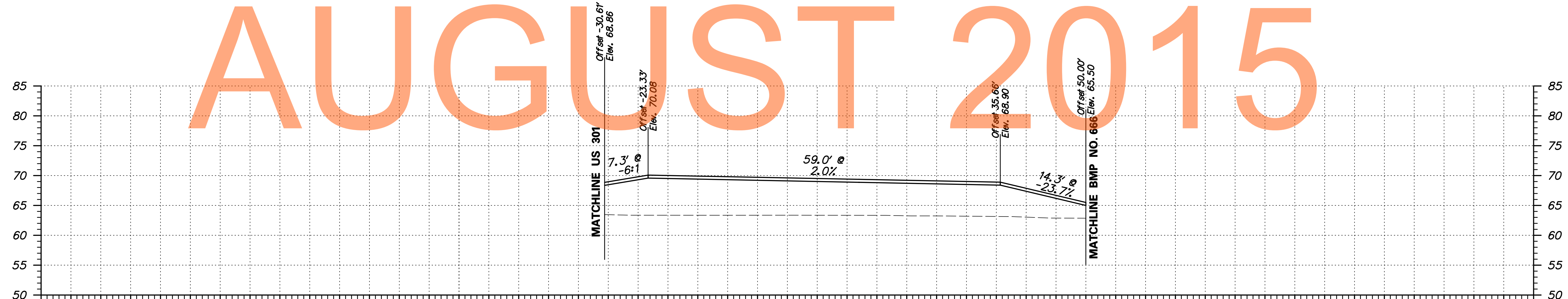
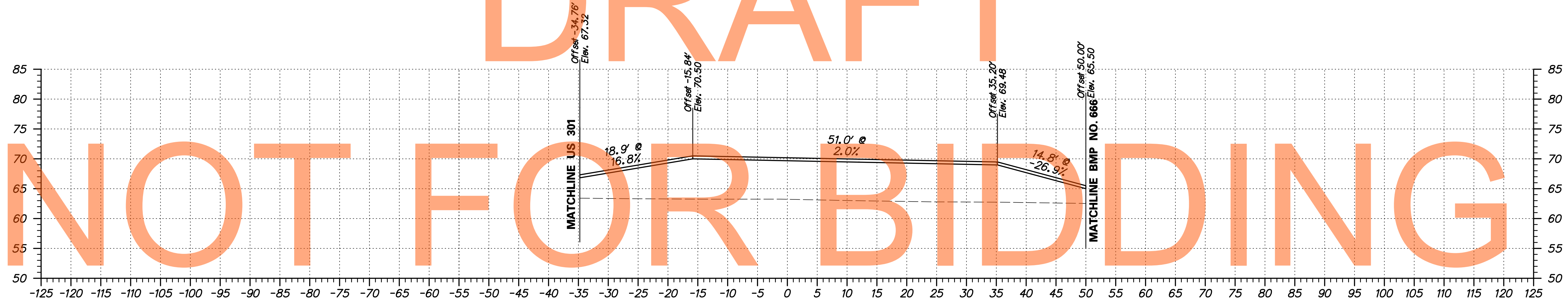
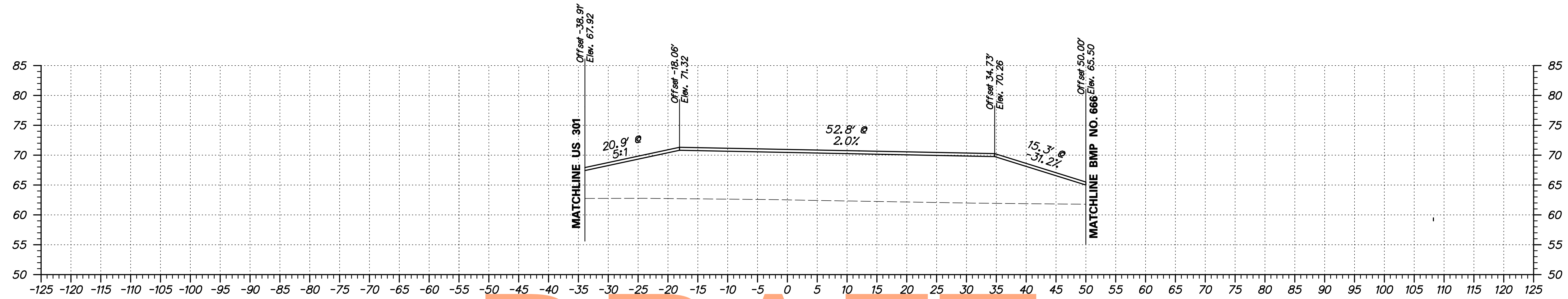

NOT FOR BIDDING

ADDENDUMS / REVISIONS	

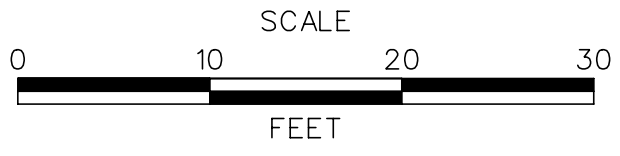

**US 301
LEVELS ROAD
TO SUMMIT BRIDGE ROAD**

CONTRACT	BRIDGE NO.	
T20091303	DESIGNED BY:	IK
COUNTY	CHECKED BY:	JH
NEW CASTLE		

**RAMP G
CROSS SECTIONS**

SHEET NO.	348
TOTAL SHTS.	518

S:\PROJECTS\TRANSPORTATION\JOBS-NR\NEW CASTLE\30N.ROAD\T20091303\PLANS\XREFS\CPBOARD XS-2A.URS.DGN



S:\PROJECTS\TRANSPORTATION\JOBS-NR\NEW CASTLE\301\ROAD\T20091303\PLANS\XREFS\CPBOARD XS-2A.URS.DGN

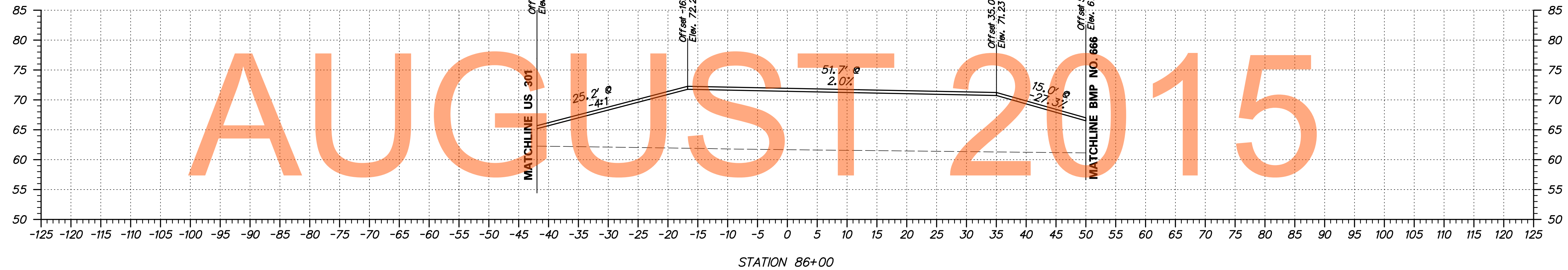
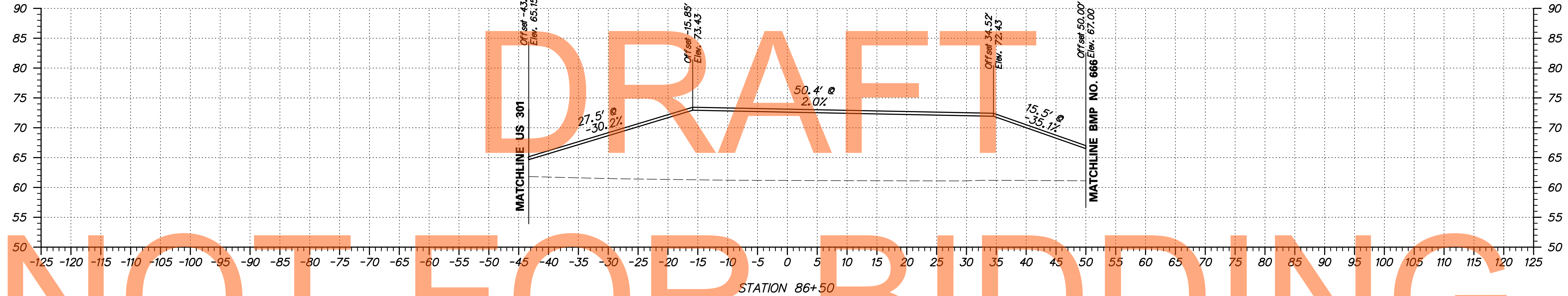
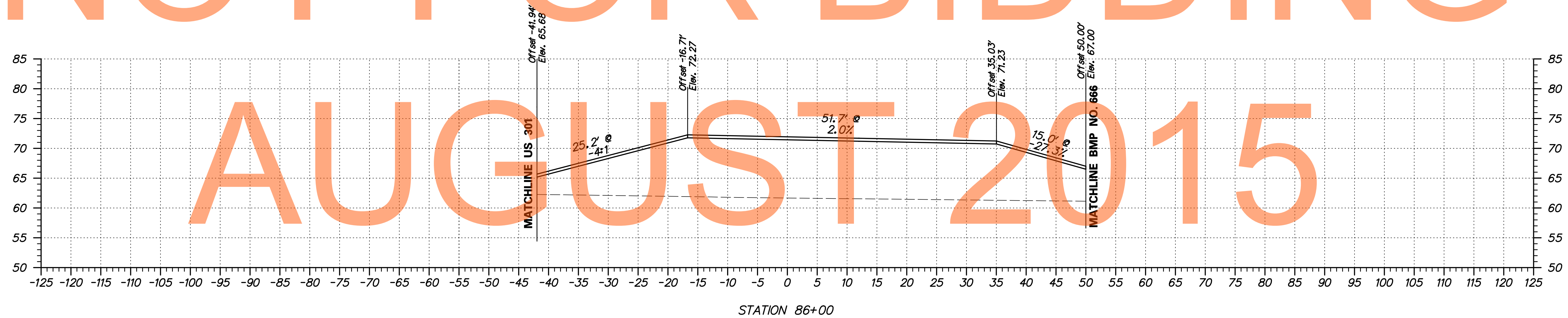
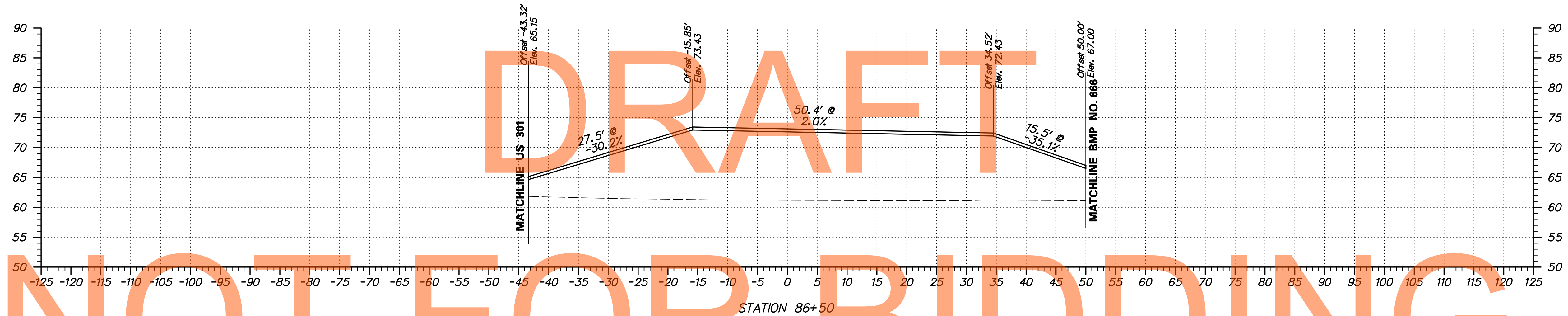

DRAFT

NOT FOR BIDDING

AUGUST 2015



ADDENDUMS / REVISIONS	

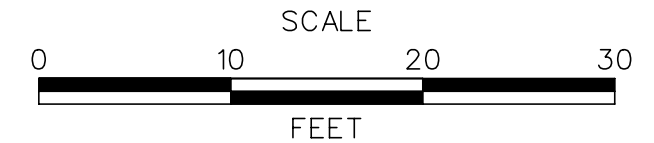

**US 301
LEVELS ROAD
TO SUMMIT BRIDGE ROAD**

CONTRACT	BRIDGE NO.	
T20091303	DESIGNED BY:	IK
COUNTY	CHECKED BY:	JH
NEW CASTLE		

**RAMP G
CROSS SECTIONS**

SHEET NO.	349
TOTAL SHTS.	518

S:\PROJECTS\TRANSPORTATION\JOBS-NR\NEW CASTLE\301\ROAD\T20091303\PLANS\XREFS\CPBOARD XS-2A.URS.DGN

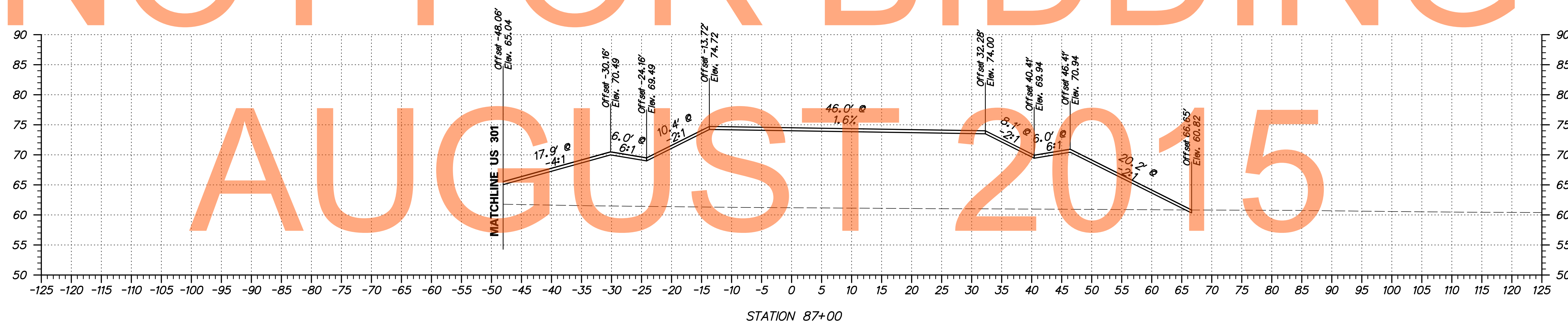
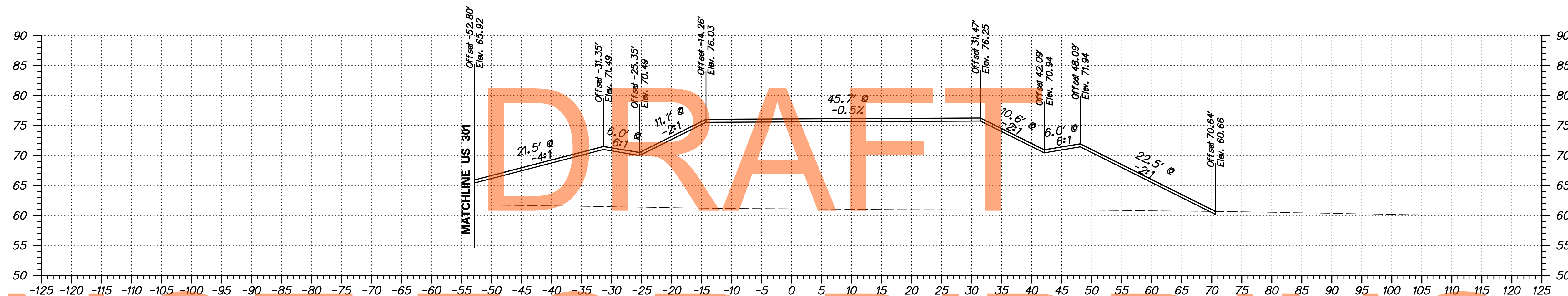

DRAFT

NOT FOR BIDDING

AUGUST 2015



**DELAWARE
DEPARTMENT OF TRANSPORTATION**

ADDENDUMS / REVISIONS

NO.	DATE	DESCRIPTION

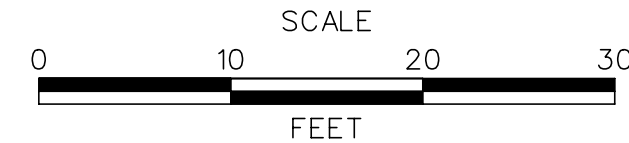

**US 301
LEVELS ROAD
TO SUMMIT BRIDGE ROAD**

CONTRACT	BRIDGE NO.	
T20091303	DESIGNED BY:	IK
COUNTY	CHECKED BY:	JH
NEW CASTLE		

**RAMP G
CROSS SECTIONS**

SHEET NO.	350
TOTAL SHTS.	518

S:\PROJECTS\TRANSPORTATION\JOBS-NR\NEW CASTLE\301\ROAD\T20091303\PLANS\XREFS\CPBOARD XS_2A.URS.DGN



ADDENDUMS / REVISIONS	

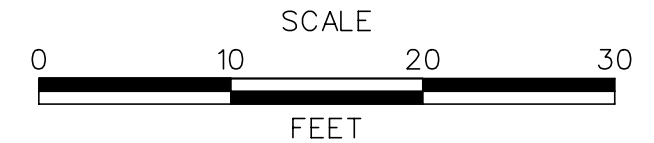

**US 301
LEVELS ROAD
TO SUMMIT BRIDGE ROAD**

CONTRACT	BRIDGE NO.	
T20091303	DESIGNED BY:	IK
COUNTY	CHECKED BY:	JH
NEW CASTLE		

**RAMP G
CROSS SECTIONS**

SHEET NO.	351
TOTAL SHTS.	518

S:\PROJECTS\TRANSPORTATION\JOBS-NR\NEW CASTLE\301\ROAD\T20091303\PLANS\XREFS\CPBORD XS_2A.URS.DGN

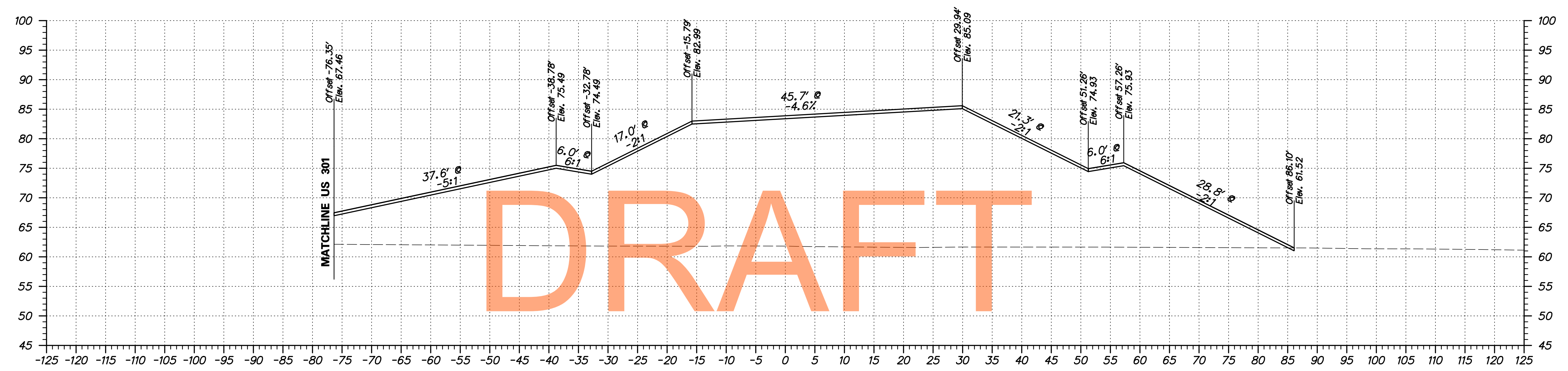

STATION 89+50

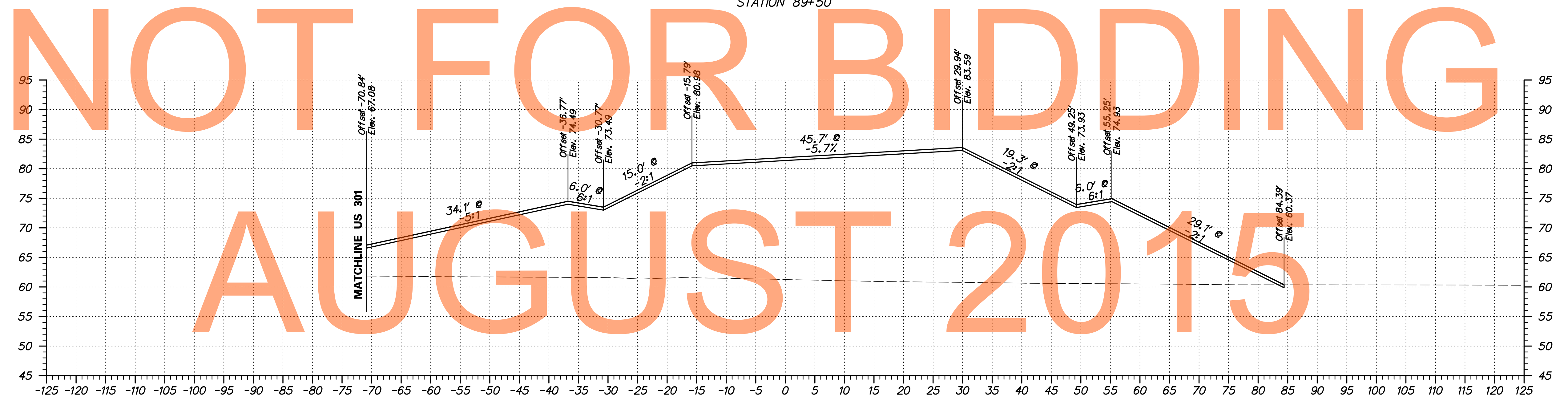

STATION 89+00

DRAFT

NOT FOR BIDDING

AUGUST 2015



ADDENDUMS / REVISIONS	

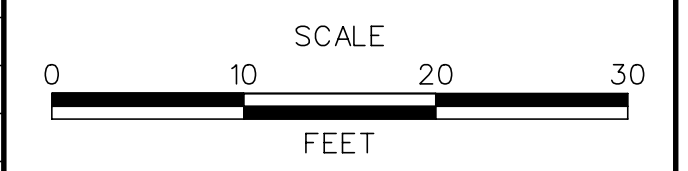

**US 301
LEVELS ROAD
TO SUMMIT BRIDGE ROAD**

CONTRACT	BRIDGE NO.	
T20091303	DESIGNED BY:	IK
COUNTY	CHECKED BY:	JH
NEW CASTLE		

**RAMP G
CROSS SECTIONS**

SHEET NO.	352
TOTAL SHTS.	518

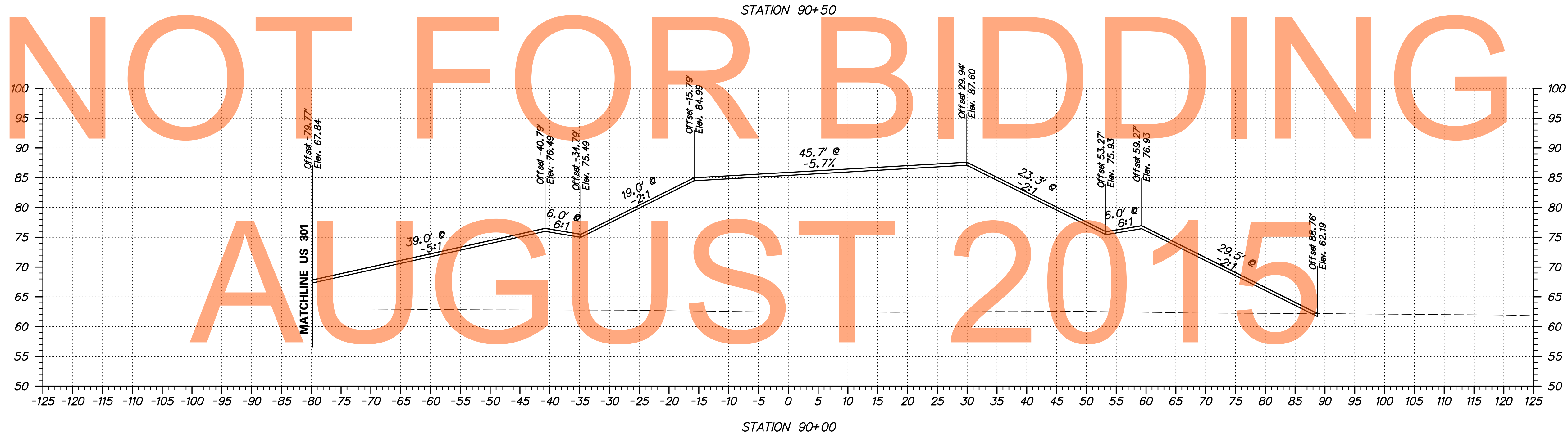
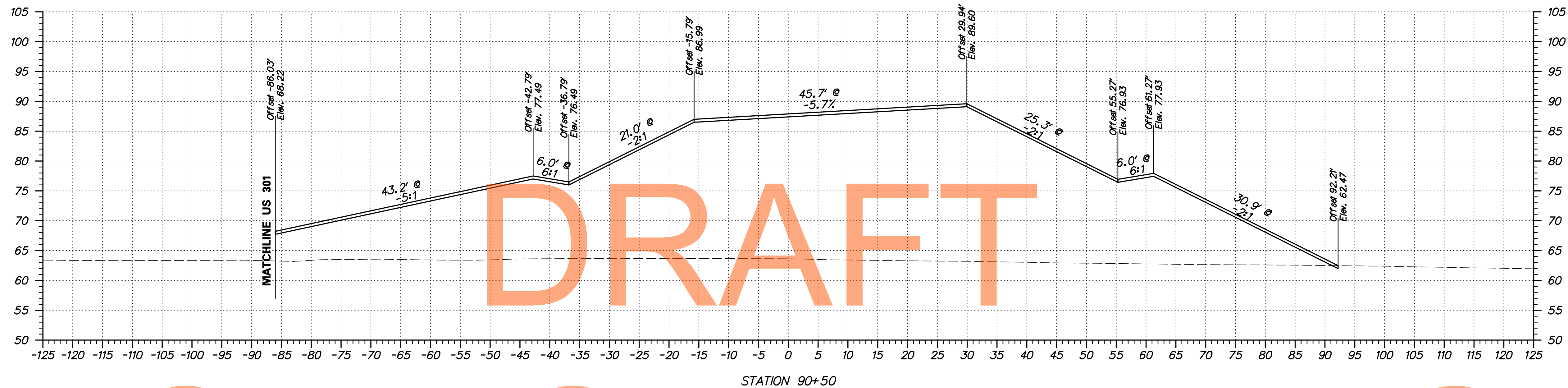

DRAFT

NOT FOR BIDDING

AUGUST 2015

S:\PROJECTS\TRANSPORTATION\JOBS-NR\NEW CASTLE\301\ROAD\T20091303\PLANS\XREFS\CPBOARD XS_2A.URS.DGN

DELAWARE DEPARTMENT OF TRANSPORTATION	ADDENDUMS / REVISIONS	SCALE 0 10 20 30 FEET	US 301 LEVELS ROAD TO SUMMIT BRIDGE ROAD	CONTRACT	BRIDGE NO.	RAMP G CROSS SECTIONS	SHEET NO.
					T20091303		
				COUNTY	CHECKED BY: JH		TOTAL SHTS.
				NEW CASTLE			518

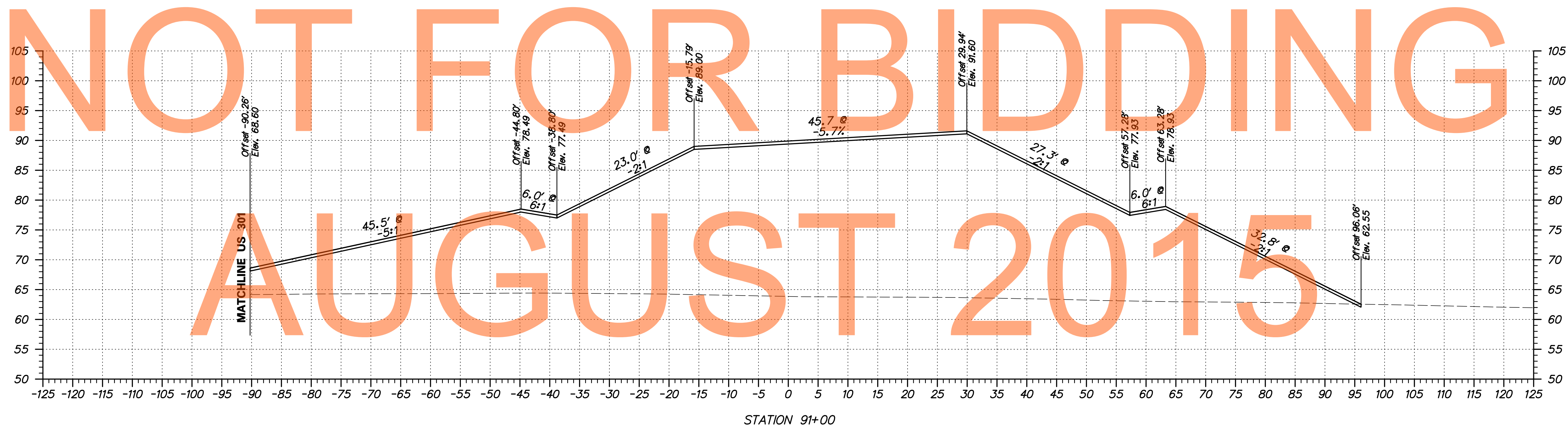
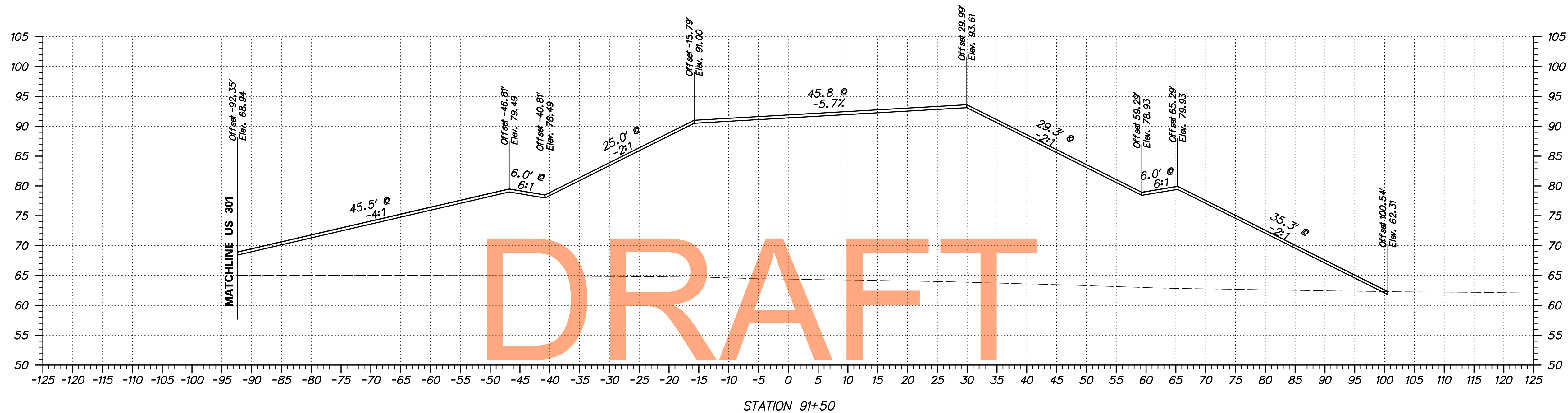

DRAFT

NOT FOR BIDDING
AUGUST 2015

S:\PROJECTS\TRANSPORTATION\JOBS-NR\NEW CASTLE\301\ROAD\T20091303\PLANS\XREFS\CPBOARD XS_2A.URS.DGN

	ADDENDUMS / REVISIONS		SCALE 0 10 20 30 FEET	US 301 LEVELS ROAD TO SUMMIT BRIDGE ROAD		CONTRACT T20091303	BRIDGE NO. 	RAMP G CROSS SECTIONS	SHEET NO. 354
					COUNTY NEW CASTLE	DESIGNED BY: IK	CHECKED BY: JH		TOTAL SHTS. 518

S:\PROJECTS\TRANSPORTATION\JOBS-NR\NEW CASTLE\301\ROAD\T20091303\PLANS\XREFS\CPBOARD XS-2A.URS.DGN

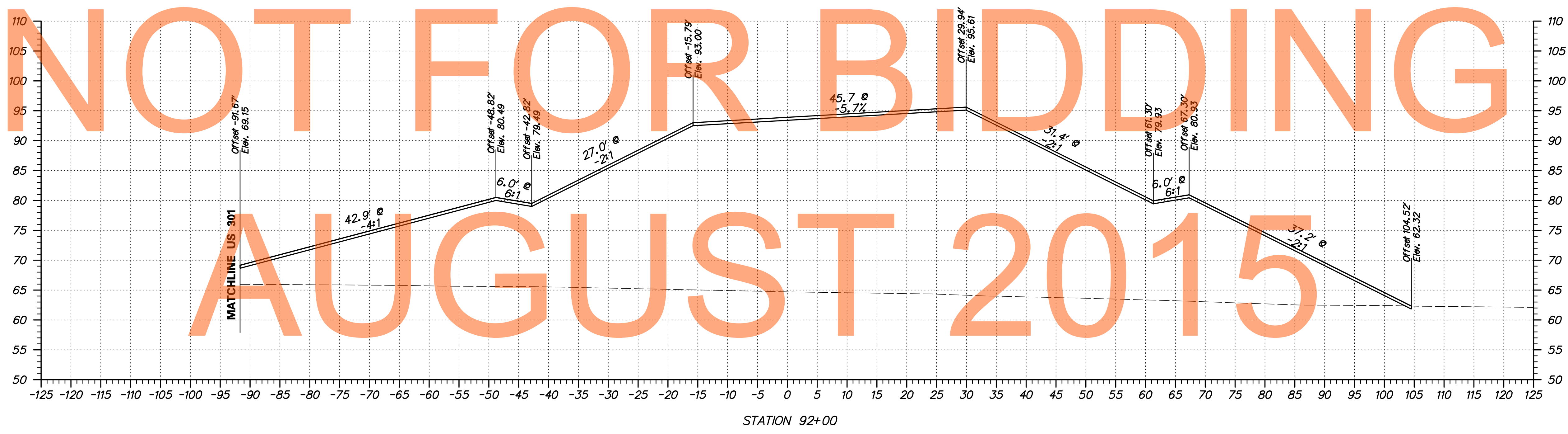
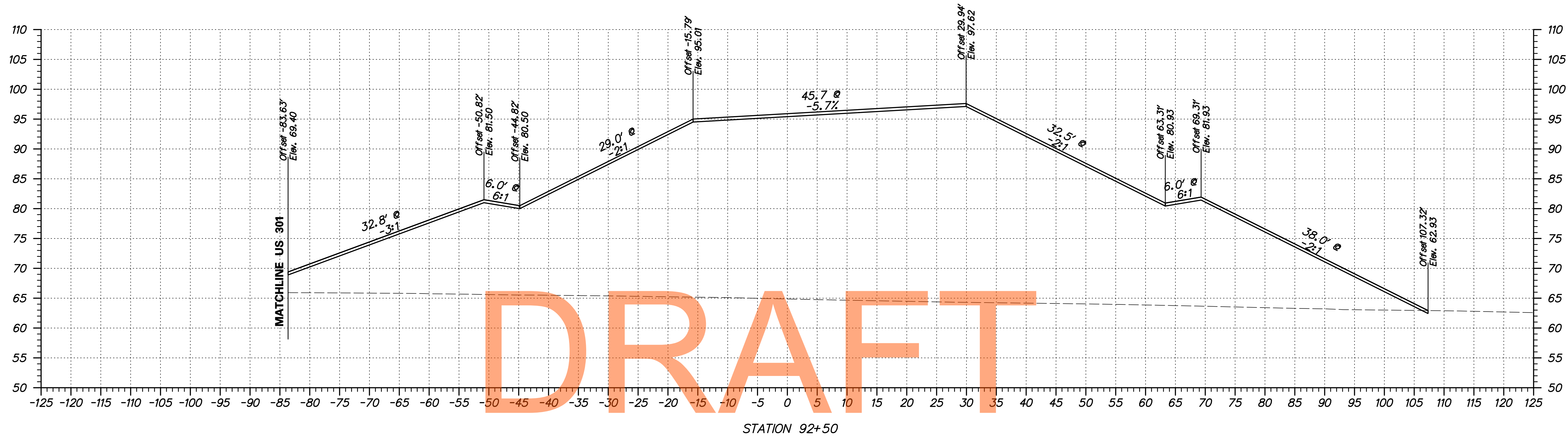

ADDENDUMS / REVISIONS	

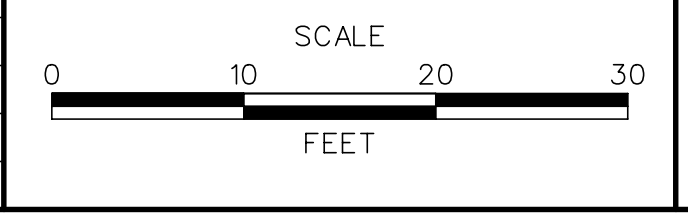

**US 301
LEVELS ROAD
TO SUMMIT BRIDGE ROAD**

CONTRACT	BRIDGE NO.	
T20091303	DESIGNED BY:	IK
COUNTY	CHECKED BY:	JH
NEW CASTLE		

**RAMP G
CROSS SECTIONS**

SHEET NO.	355
TOTAL SHTS.	518

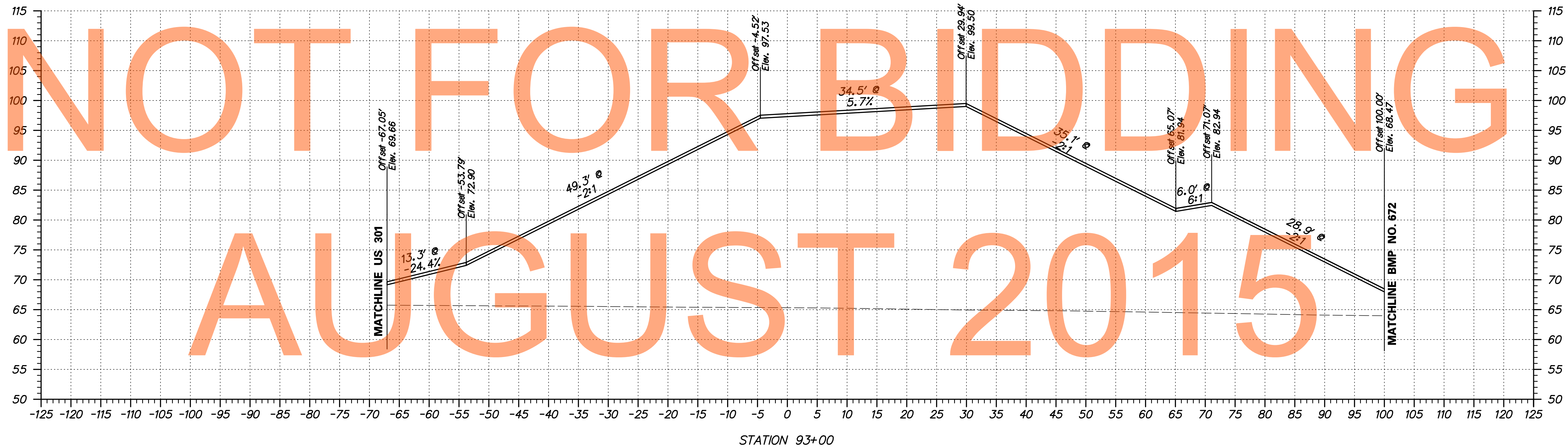
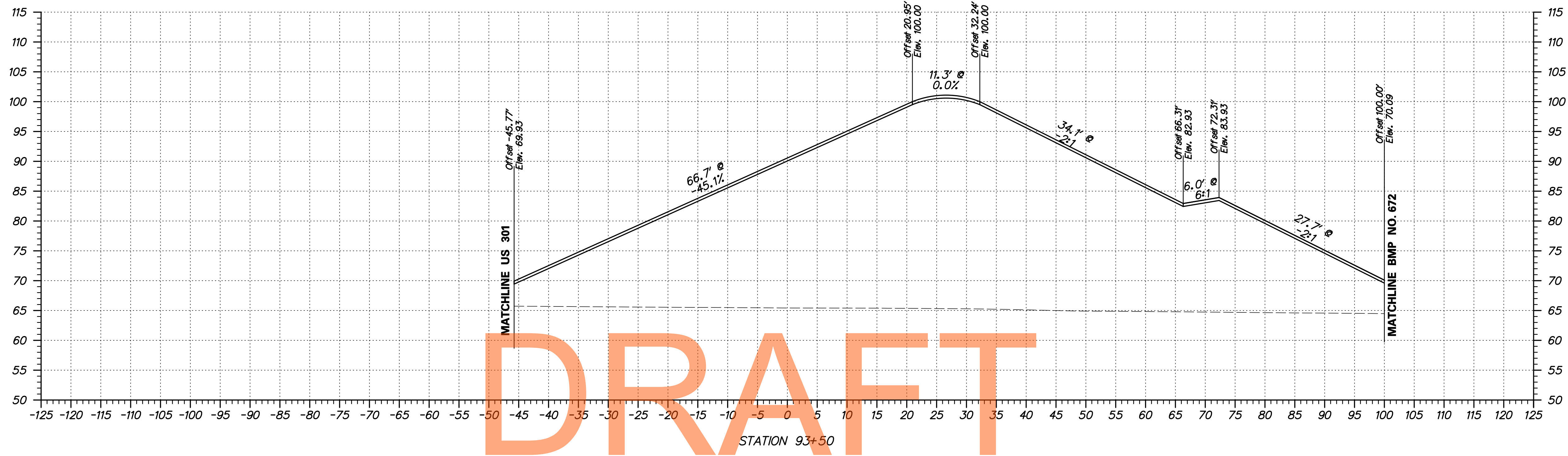

DRAFT

NOT FOR BIDDING
AUGUST 2015

S:\PROJECTS\TRANSPORTATION\JOBS-NR\NEW CASTLE\301\ROAD\T20091303\PLANS\XREFS\CPBOARD XS-2A.URS.DGN

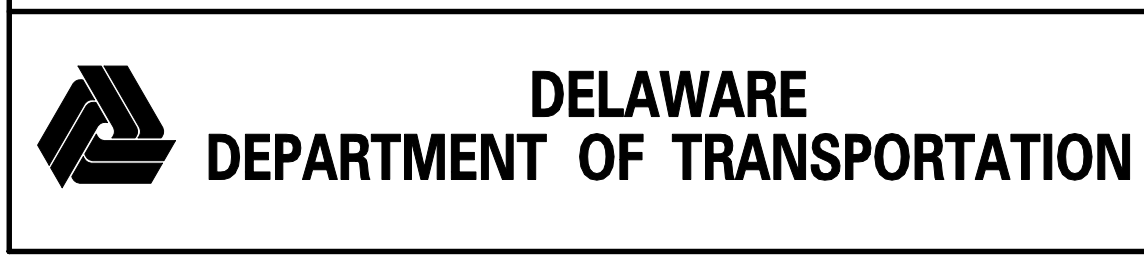

ADDENDUMS / REVISIONS	

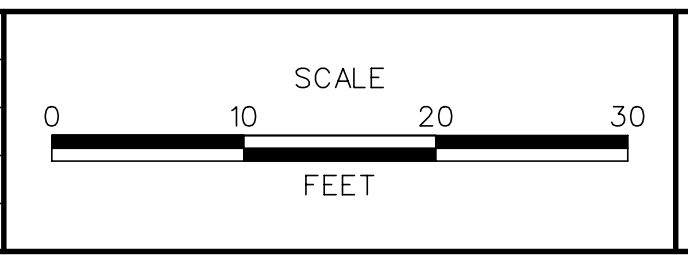

**US 301
LEVELS ROAD
TO SUMMIT BRIDGE ROAD**

CONTRACT T20091303	BRIDGE NO.	
COUNTY NEW CASTLE	DESIGNED BY:	IK
	CHECKED BY:	JH

**RAMP G
CROSS SECTIONS**

SHEET NO. 356
TOTAL SHTS. 518

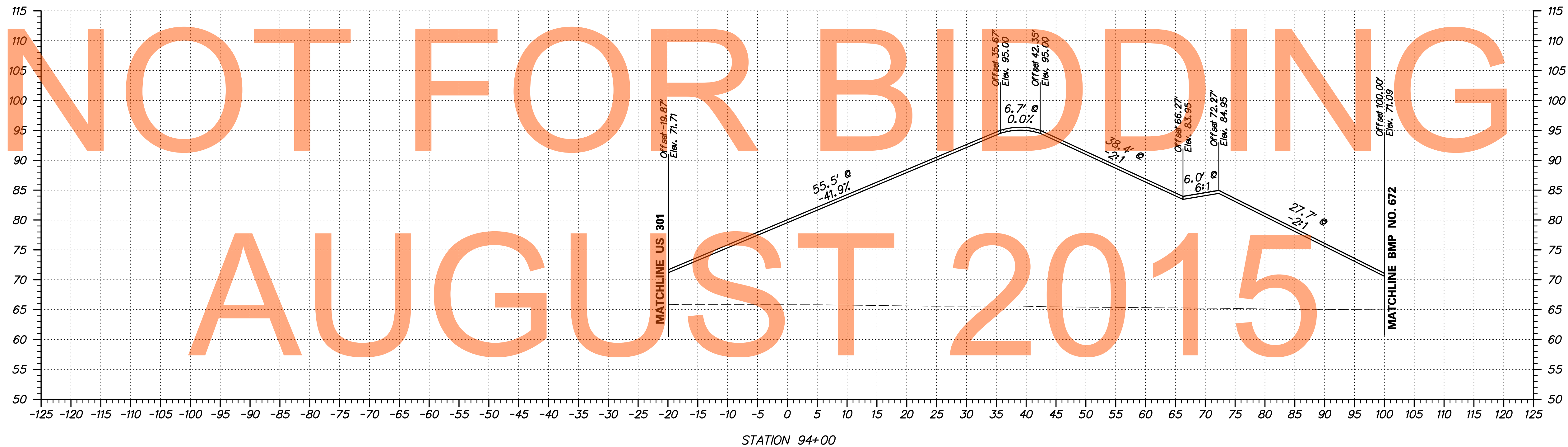
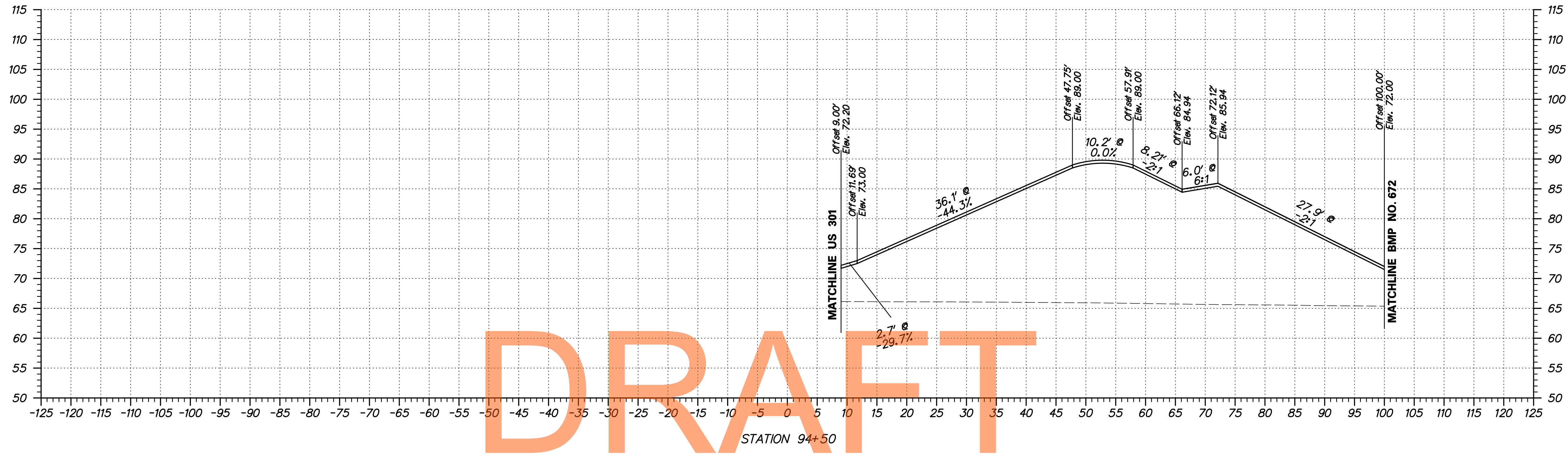

DRAFT

NOT FOR BIDDING
AUGUST 2015

S:\PROJECTS\TRANSPORTATION\JOBS-NR\NEW CASTLE\301\ROAD\T20091303\PLANS\XREFS\CPBOARD XS-2A.URS.DGN



ADDENDUMS / REVISIONS	

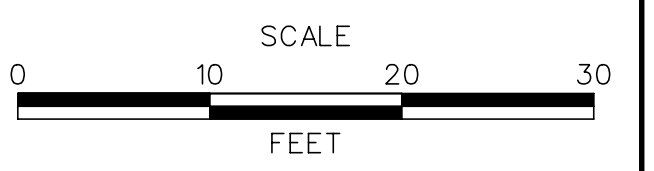

US 301
LEVELS ROAD
TO SUMMIT BRIDGE ROAD

CONTRACT	BRIDGE NO.	
T20091303	DESIGNED BY:	IK
COUNTY	CHECKED BY:	JH
NEW CASTLE		

RAMP G
CROSS SECTIONS

SHEET NO.	357
TOTAL SHTS.	518

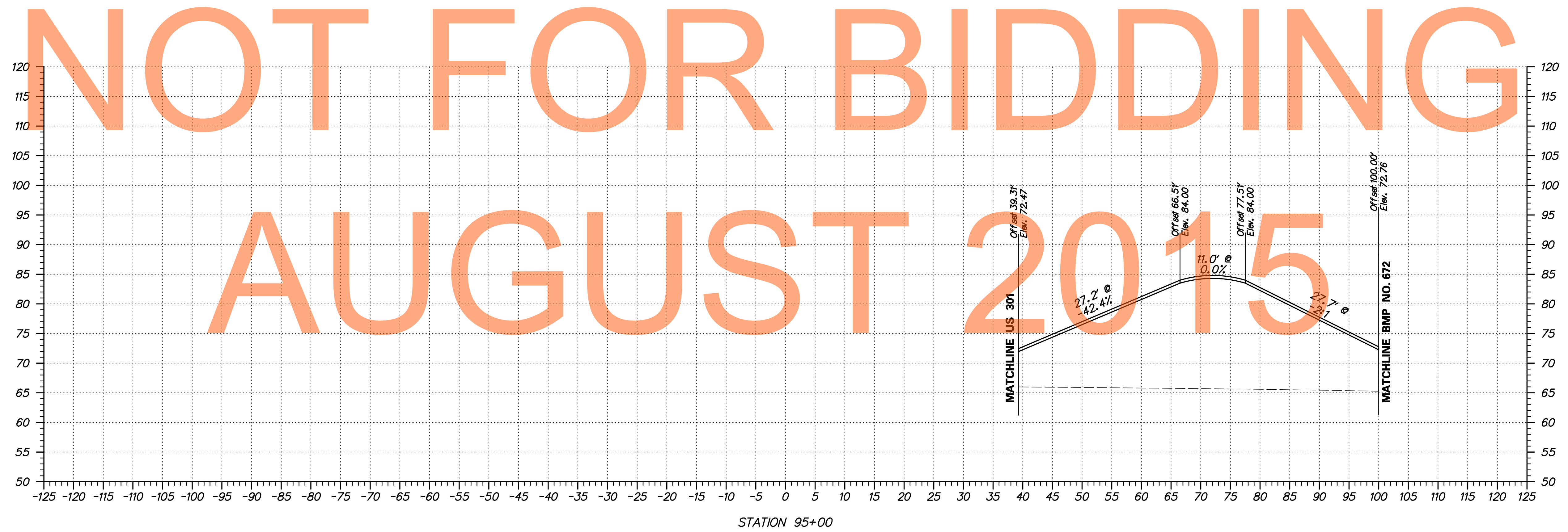
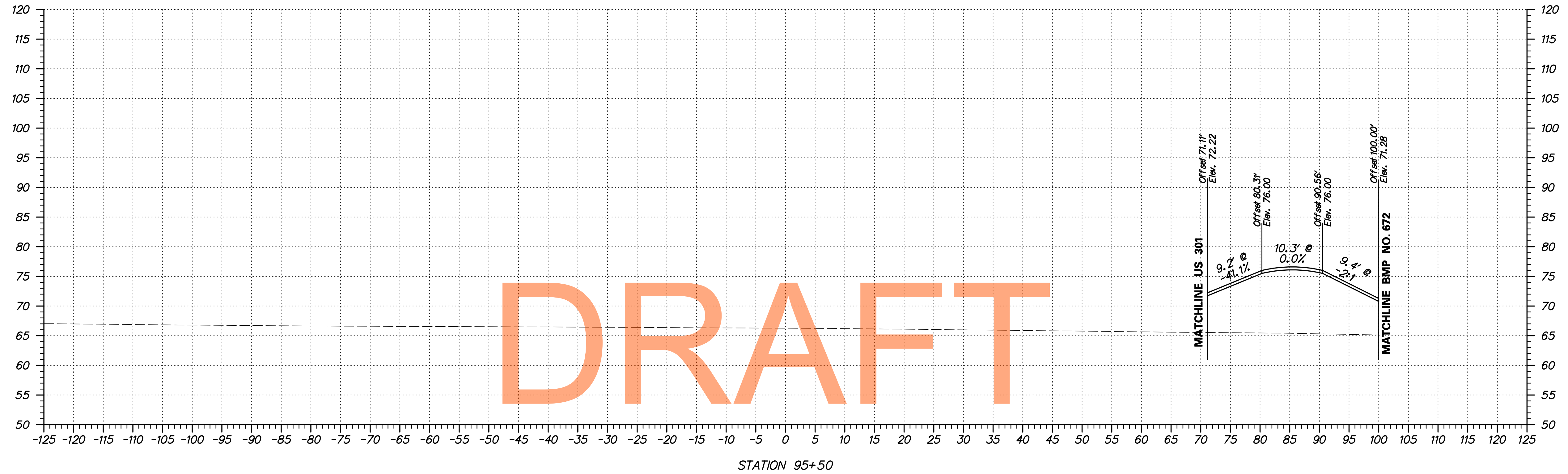

S:\PROJECTS\TRANSPORTATION\JOBS-NR\NEW CASTLE\301\ROAD\T20091303\PLANS\XREFS\CPBOARD XS_2A.URS.DGN

DRAFT

NOT FOR BIDDING

AUGUST 2015

ADDENDUMS / REVISIONS	

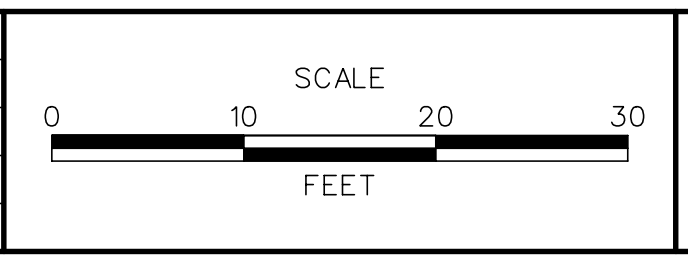

CONTRACT T20091303	BRIDGE NO.
COUNTY NEW CASTLE	DESIGNED BY: IK
	CHECKED BY: JH

S:\PROJECTS\TRANSPORTATION\JOBS-NR\NEW CASTLE\301\ROAD\T20091303\PLANS\XREFS\CPBOARD XS-2A.URS.DGN

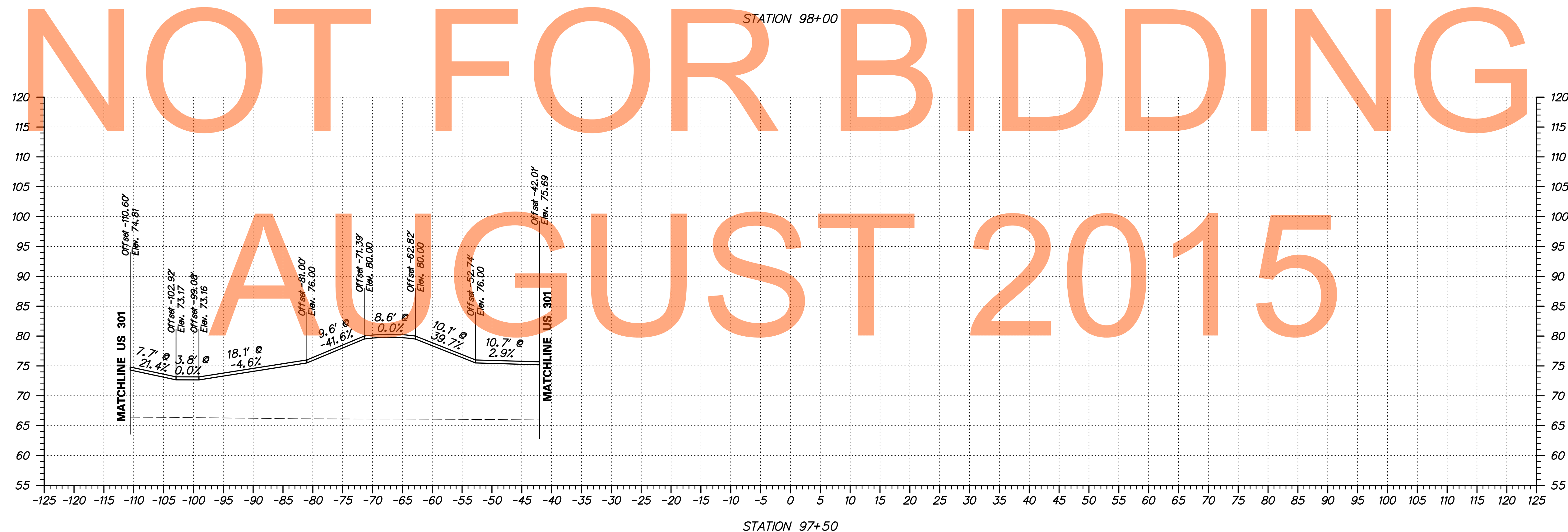
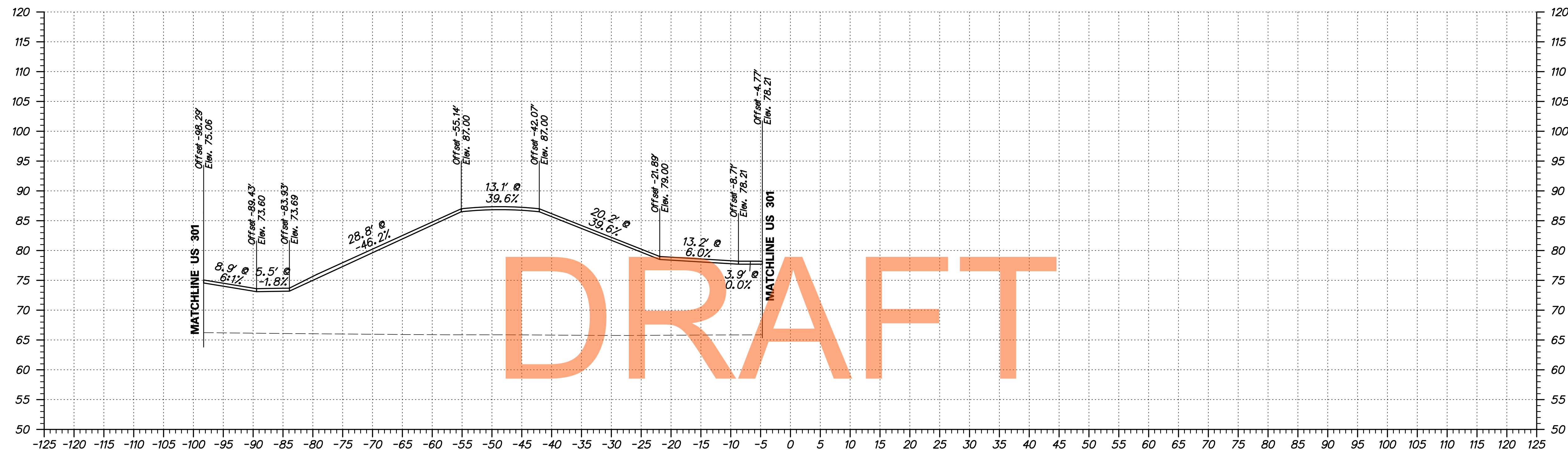

DRAFT

NOT FOR BIDDING

AUGUST 2015



ADDENDUMS / REVISIONS	

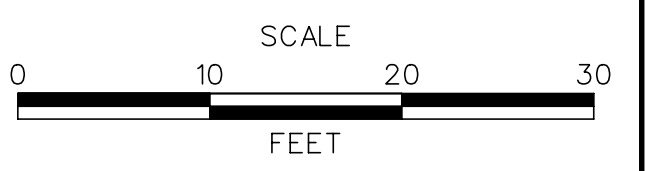

**US 301
LEVELS ROAD
TO SUMMIT BRIDGE ROAD**

CONTRACT	BRIDGE NO.	
T20091303	DESIGNED BY:	IK
COUNTY	CHECKED BY:	JH
NEW CASTLE		

**RAMP G
CROSS SECTIONS**

SHEET NO.	359
TOTAL SHTS.	518

S:\PROJECTS\TRANSPORTATION\JOBS-NEW\CASTLE\301\ROAD\T20091303\PLANS\XREFS\CPBOARD_XS_2A_URS.DGN

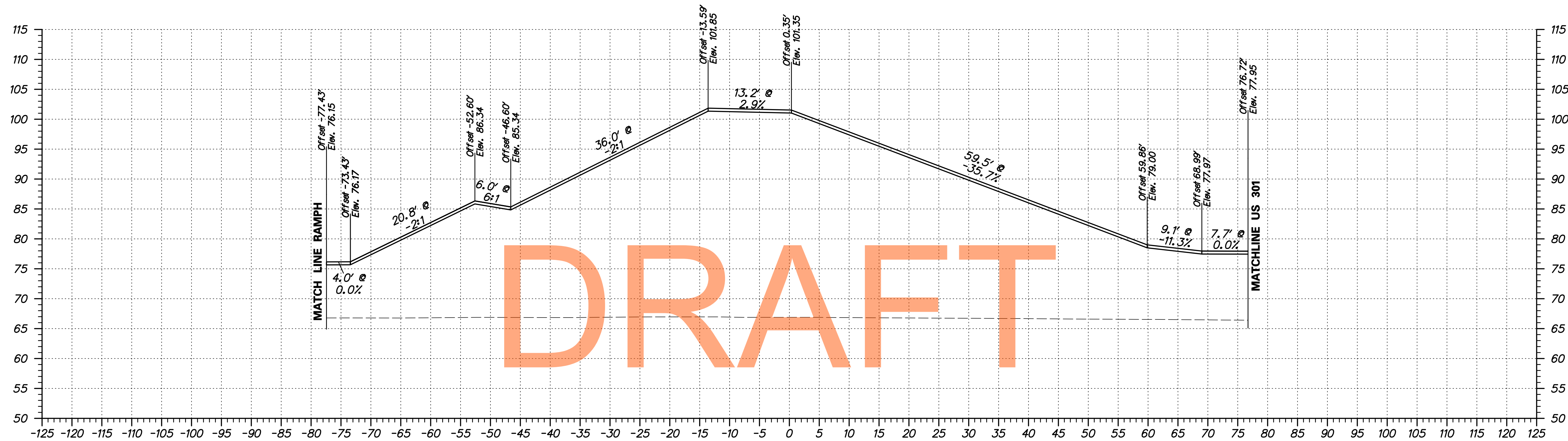

STATION 99+00

NOT FOR BIDDING

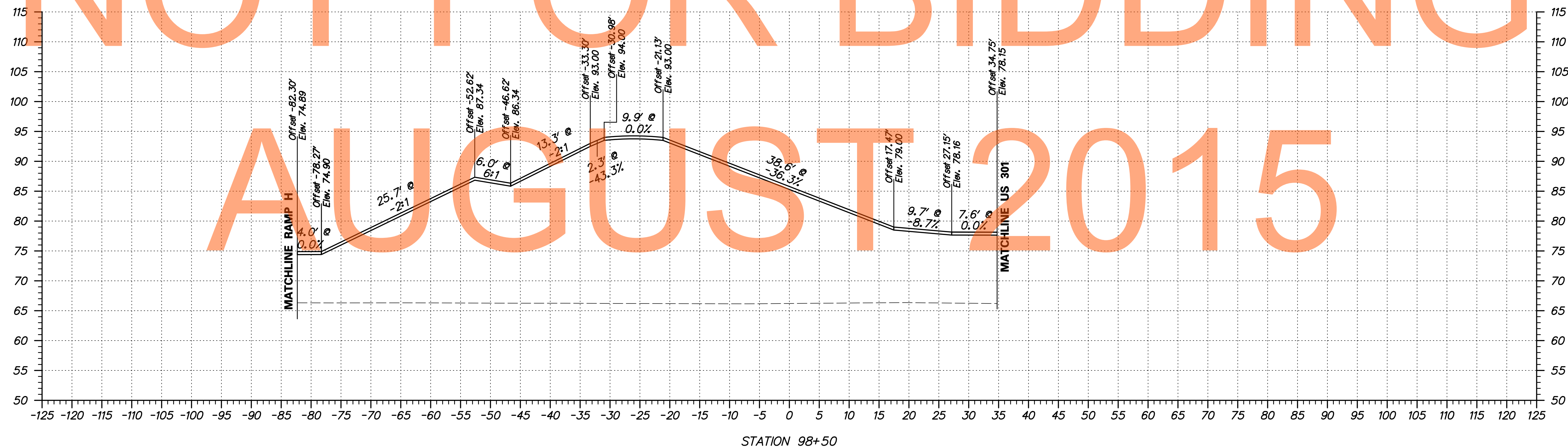

STATION 98+50



ADDENDUMS / REVISIONS	

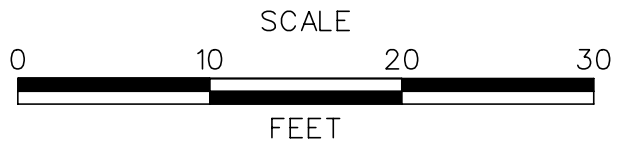

US 301 LEVELS ROAD TO SUMMIT BRIDGE ROAD

CONTRACT	BRIDGE NO.	
T20091303	DESIGNED BY:	IK
COUNTY	CHECKED BY:	JH
NEW CASTLE		

RAMP G CROSS SECTIONS

SHEET NO.	360
TOTAL SHTS.	518

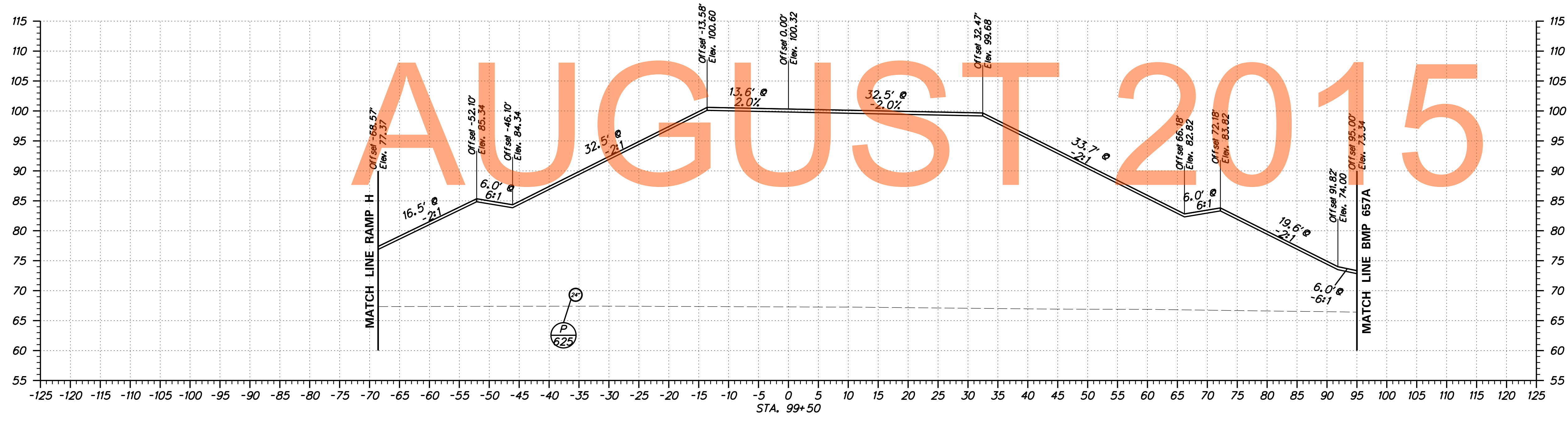
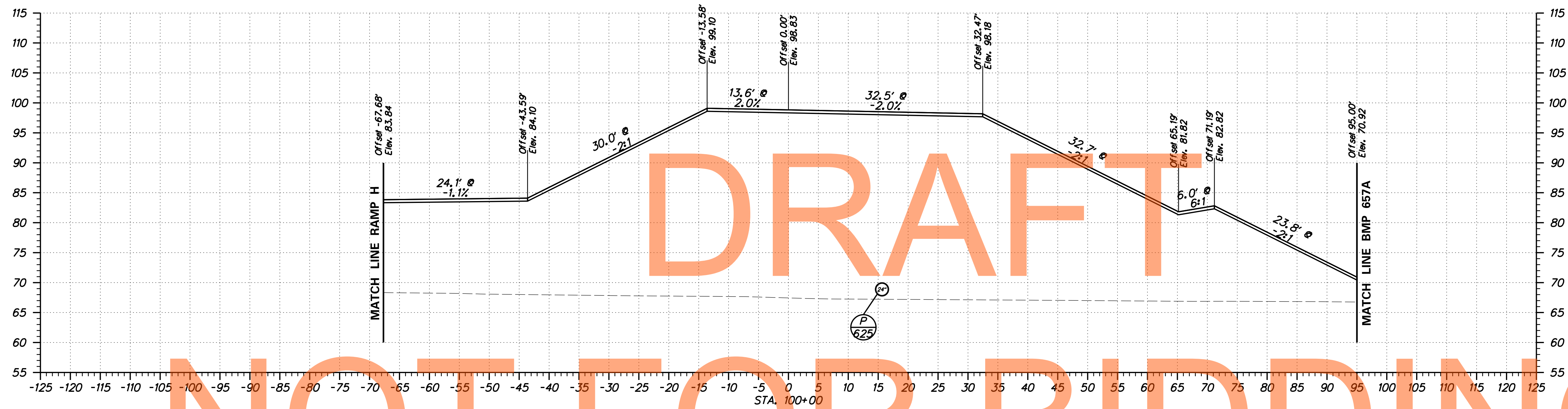

DRAFT
NOT FOR BIDDING

AUGUST 2015

ADDENDUMS / REVISIONS

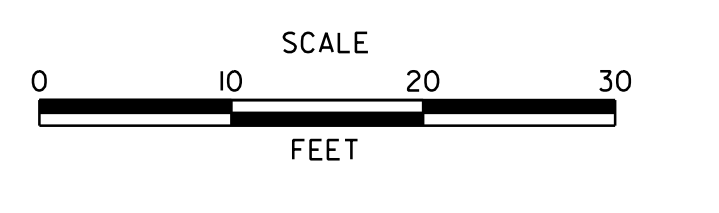

US 301
LEVELS ROAD
TO SUMMIT BRIDGE ROAD

CONTRACT T200911303	BRIDGE NO.
COUNTY NEW CASTLE	DESIGNED BY: WRC CHECKED BY: WAM

RAMP G
CROSS SECTIONS

SHEET NO. 361
TOTAL SHTS. 518

DRAFT

NOT FOR BIDDING

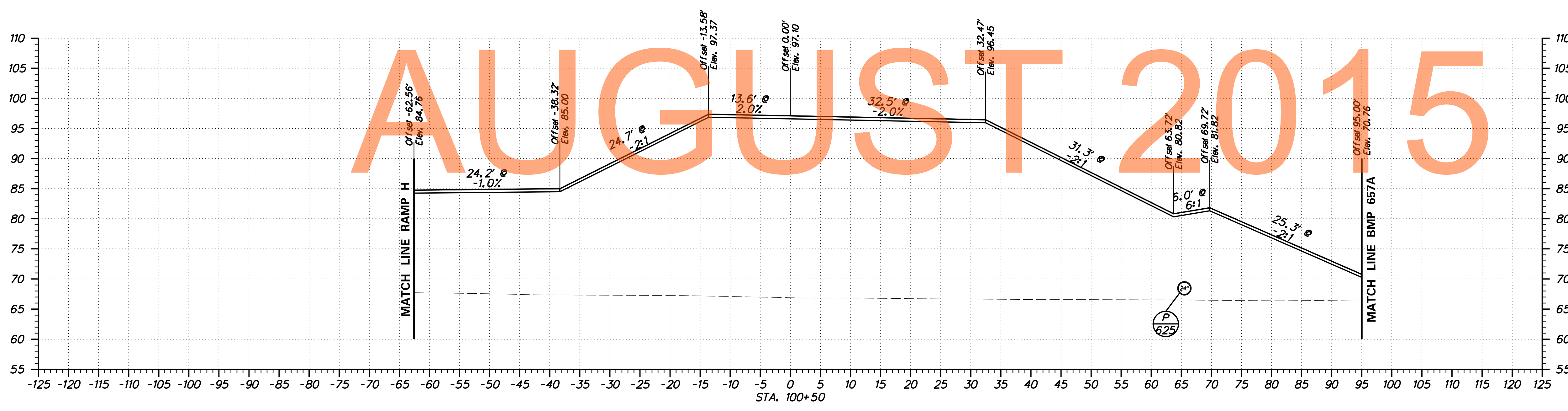
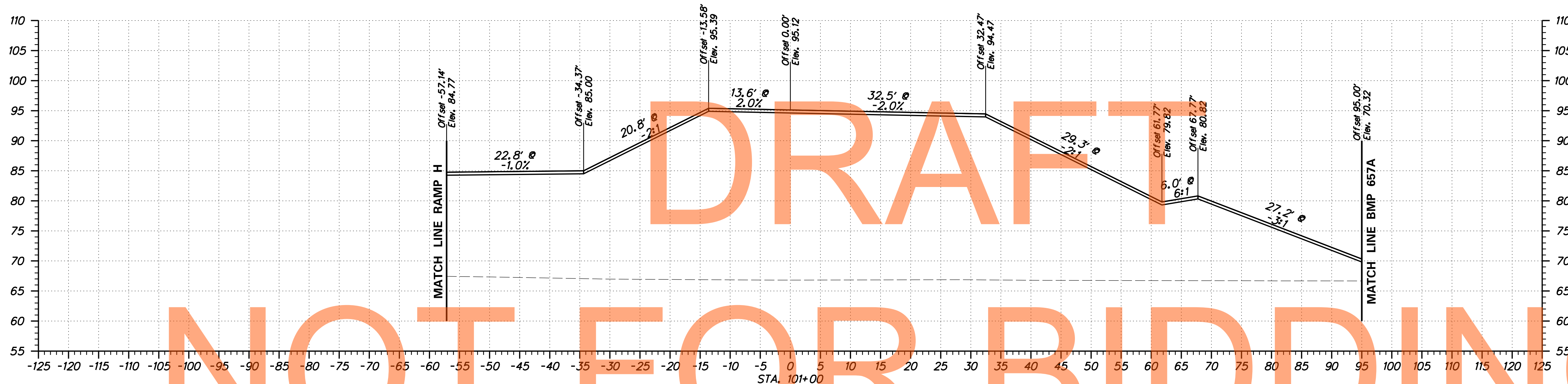

ADDENDUMS / REVISIONS

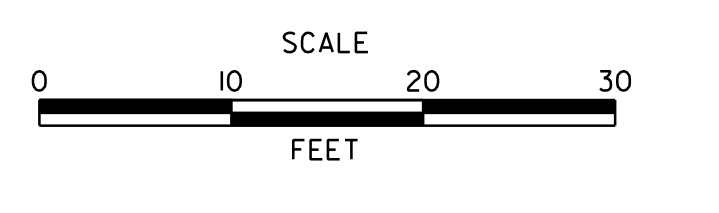

US 301
LEVELS ROAD
TO SUMMIT BRIDGE ROAD

CONTRACT T20091303	BRIDGE NO.
COUNTY NEW CASTLE	DESIGNED BY: WRC CHECKED BY: WAM

RAMP G
CROSS SECTIONS

SHEET NO. 362
TOTAL SHTS. 518

DRAFT

NOT FOR BIDDING

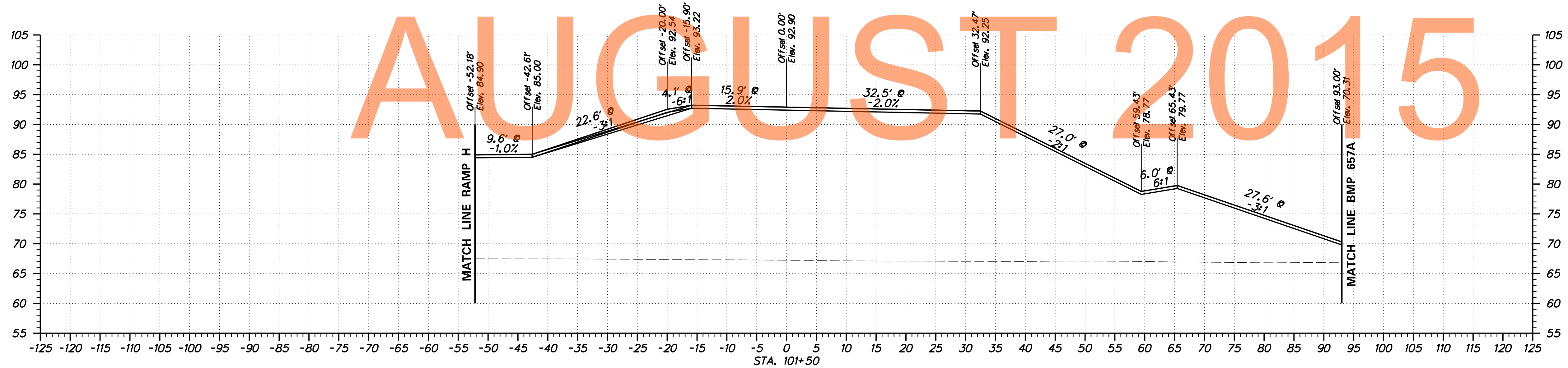
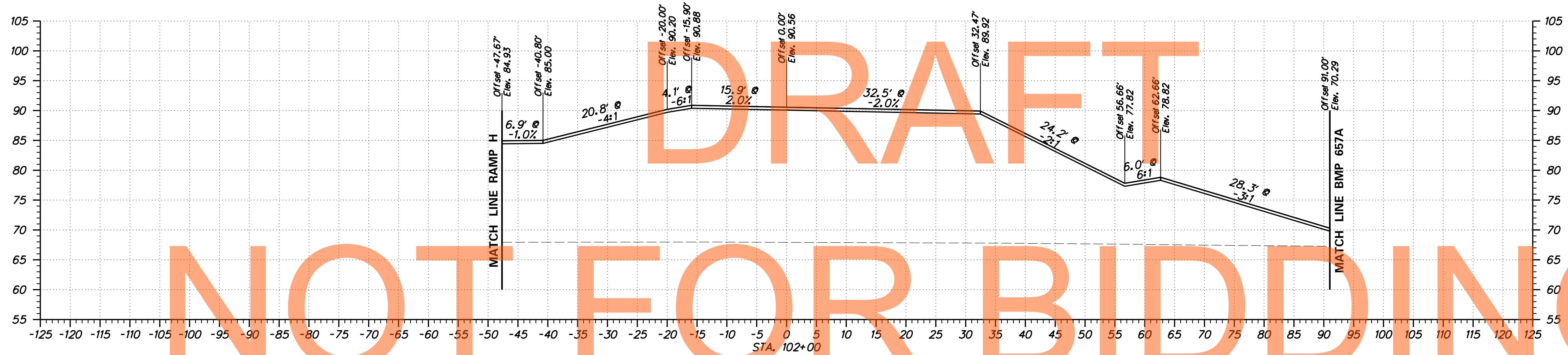

ADDENDUMS / REVISIONS

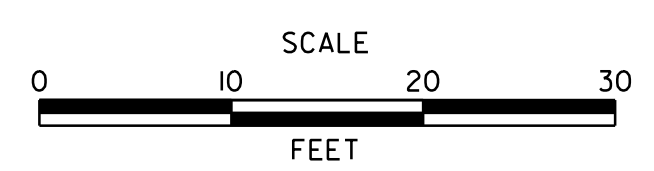

**US 301
LEVELS ROAD
TO SUMMIT BRIDGE ROAD**

CONTRACT	BRIDGE NO.
T200911303	DESIGNED BY: WRC
COUNTY	CHECKED BY: WAM
NEW CASTLE	

**RAMP G
CROSS SECTIONS**

SHEET NO.
363
TOTAL SHTS.
518



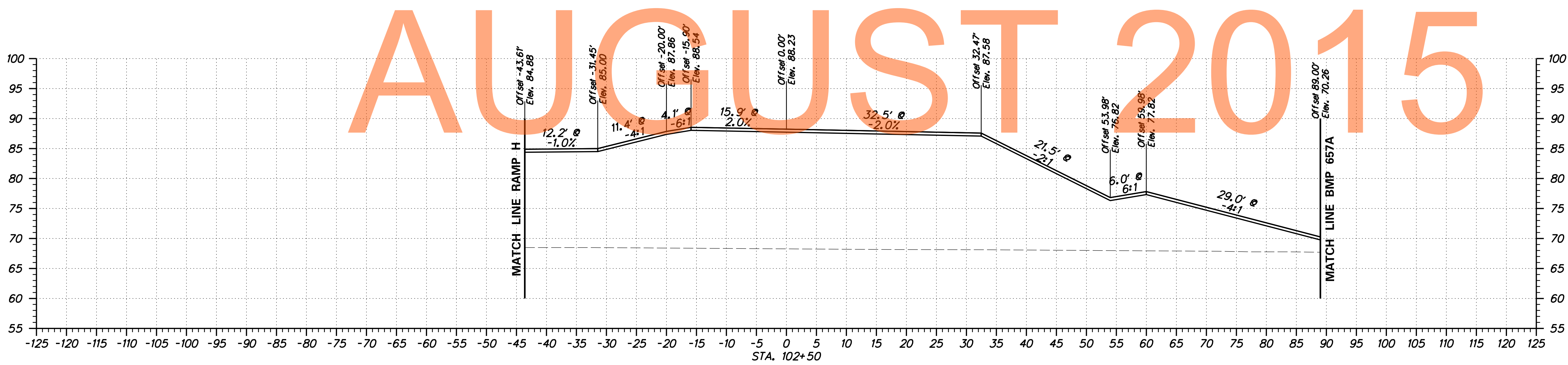
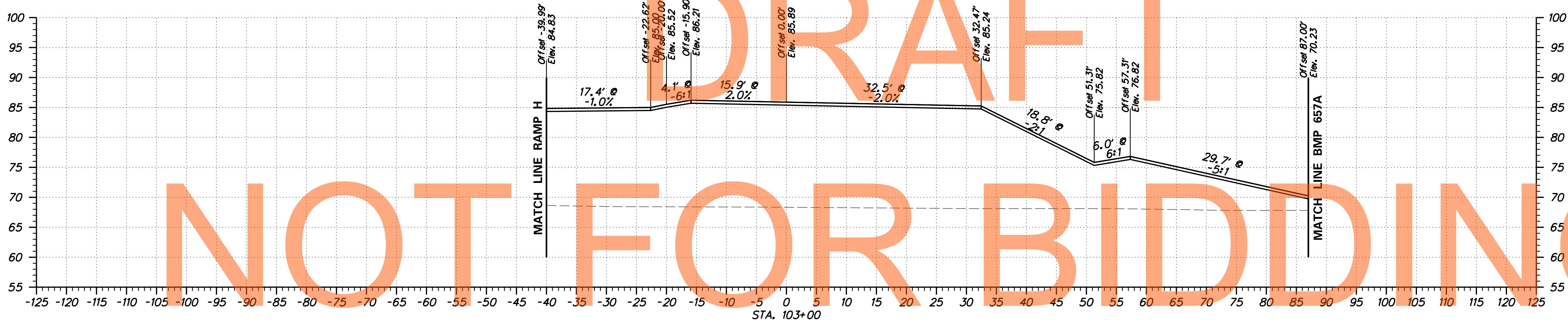
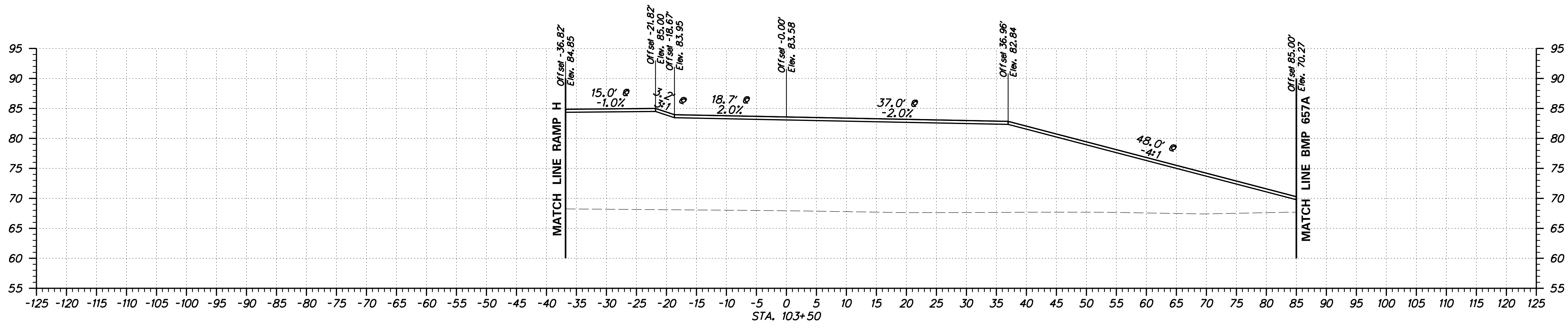

DRAFT
NOT FOR BIDDING
AUGUST 2015

ADDENDUMS / REVISIONS

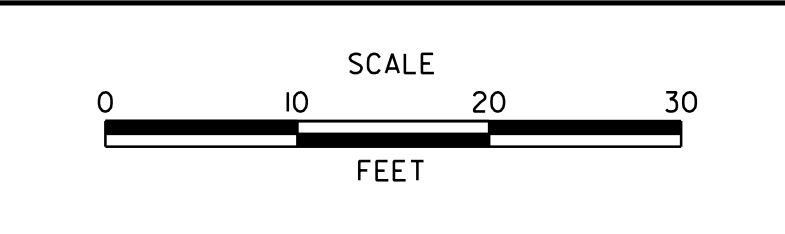

**US 301
LEVELS ROAD
TO SUMMIT BRIDGE ROAD**

CONTRACT	BRIDGE NO.
T200911303	
COUNTY	DESIGNED BY: WRC
NEW CASTLE	CHECKED BY: WAM

**RAMP G
CROSS SECTIONS**

SHEET NO.
364
TOTAL SHTS.
518

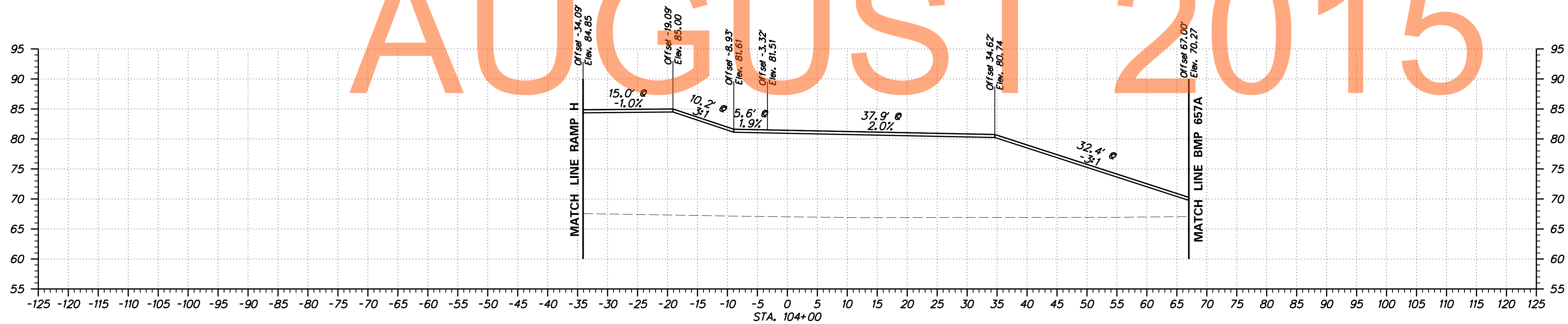
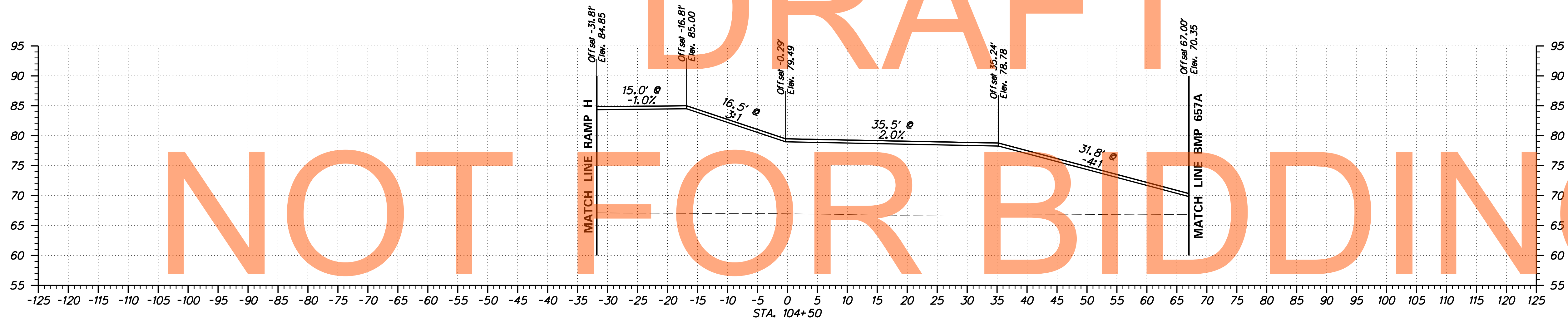
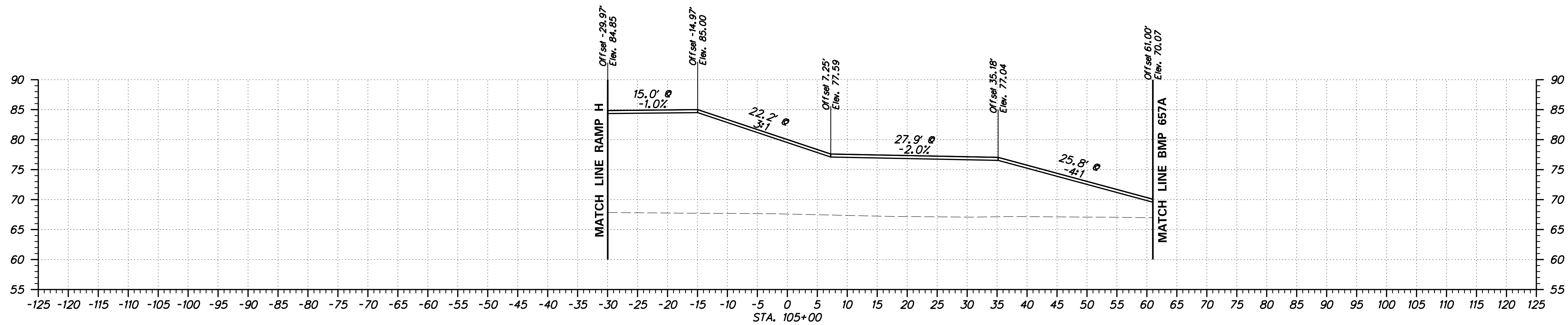

DRAFT
NOT FOR BIDDING
AUGUST 2015

DRAFT

NOT FOR BIDDING

AUGUST 2015

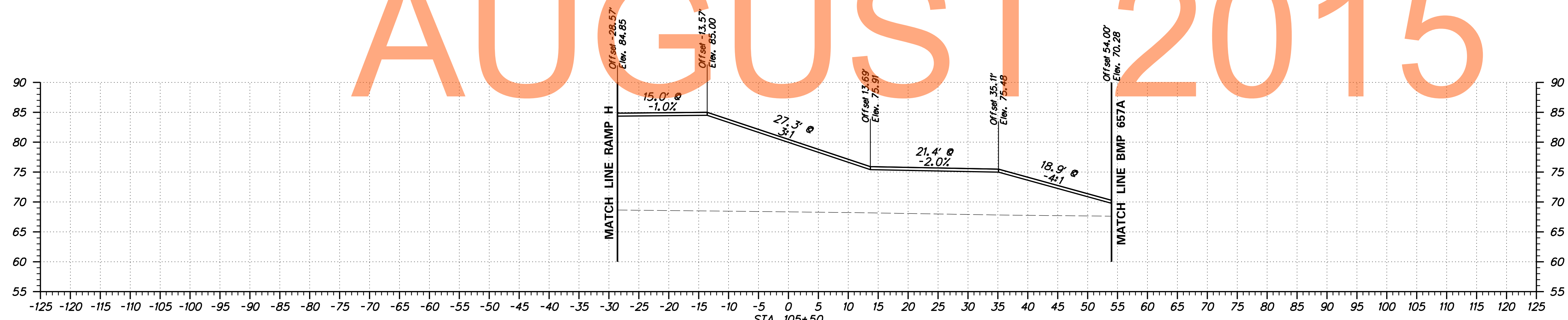
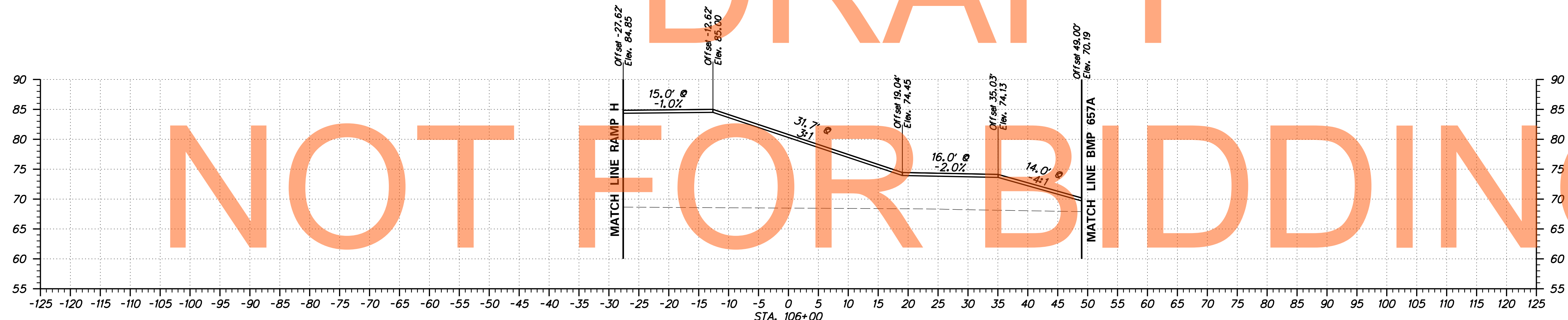
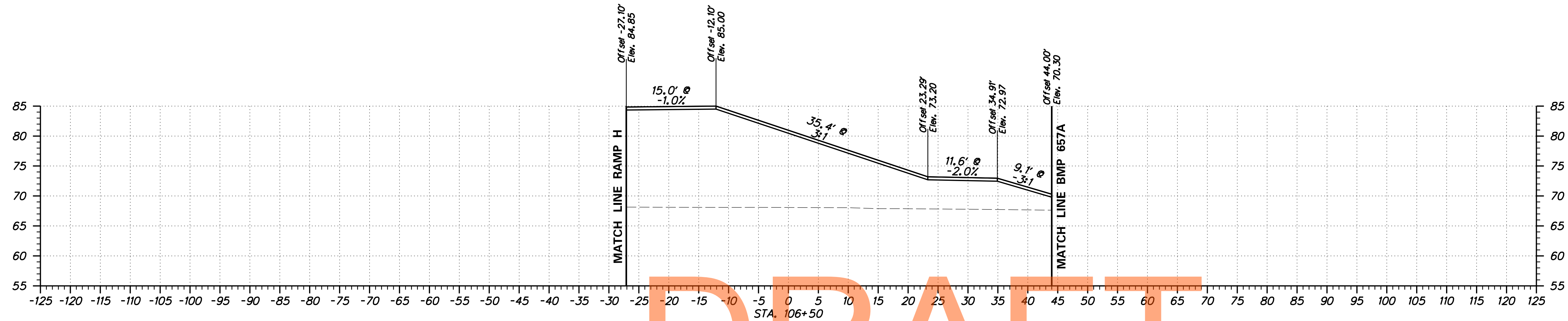

DRAFT

NOT FOR BIDDING

AUGUST 2015

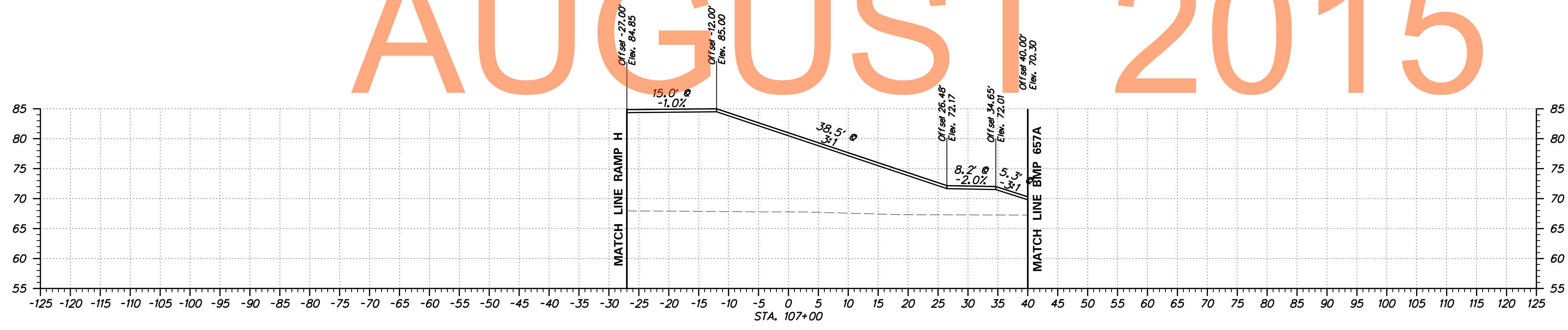
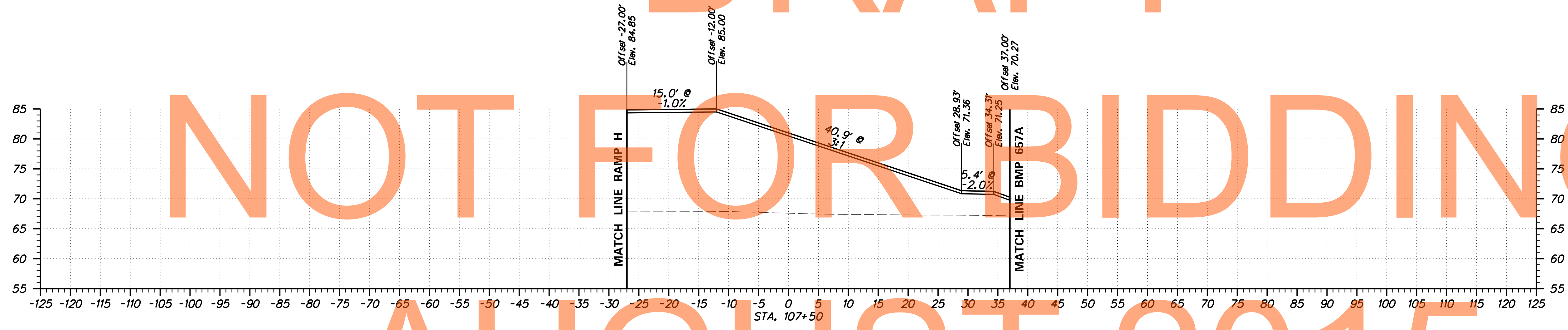
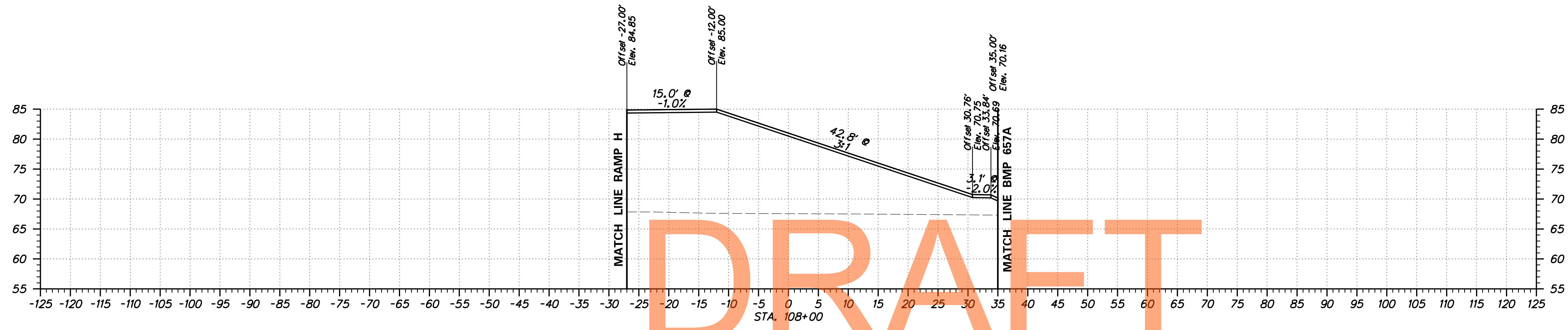

ADDENDUMS / REVISIONS

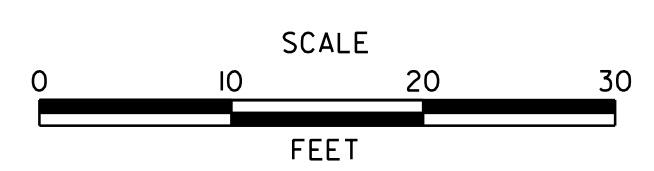

US 301
LEVELS ROAD
TO SUMMIT BRIDGE ROAD

CONTRACT	BRIDGE NO.
T20091303	DESIGNED BY: WRC
COUNTY	CHECKED BY: WAM
NEW CASTLE	

RAMP G
CROSS SECTIONS

SHEET NO.
367
TOTAL SHTS.
518



DRAFT

NOT FOR BIDDING

AUGUST 2015

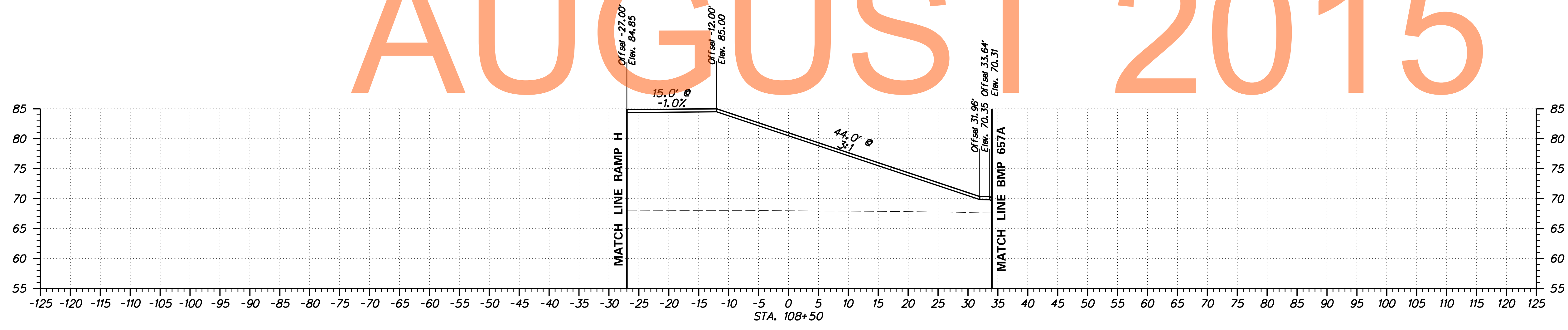
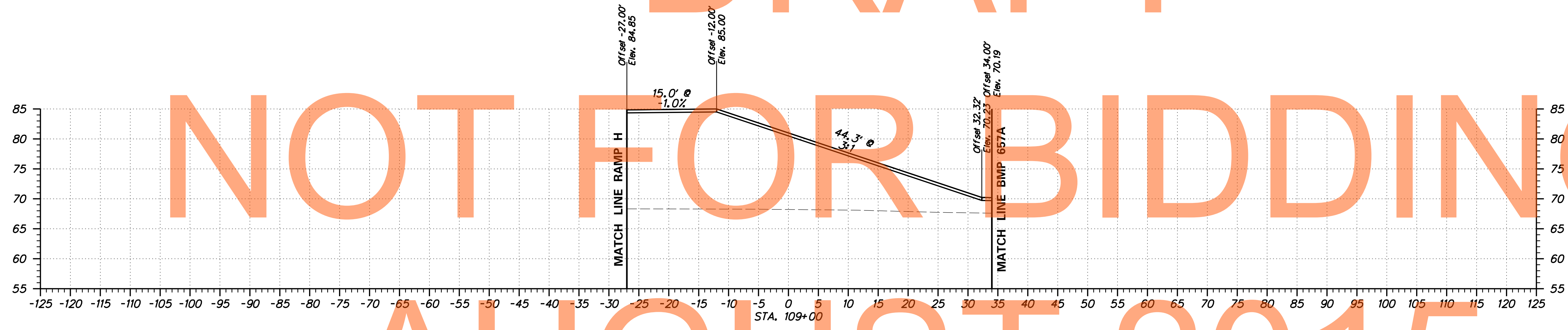
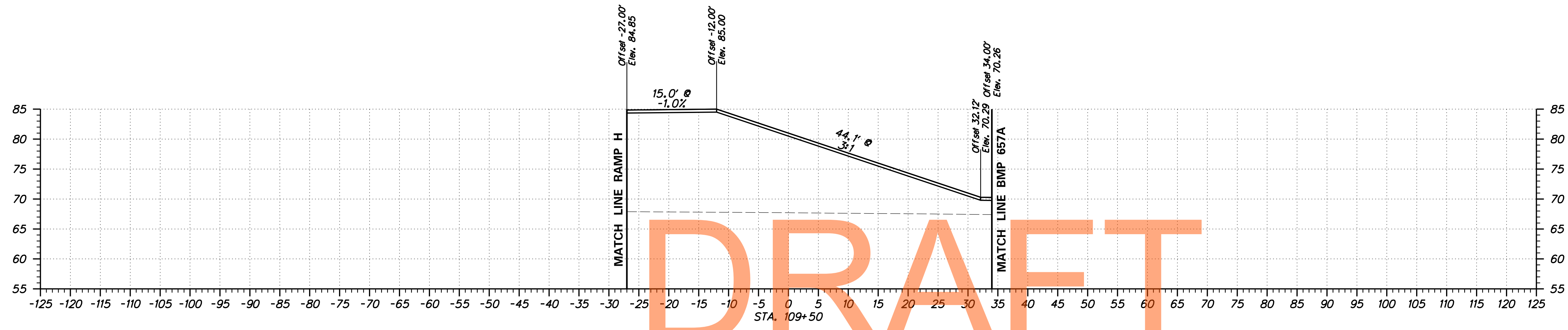

ADDENDUMS / REVISIONS

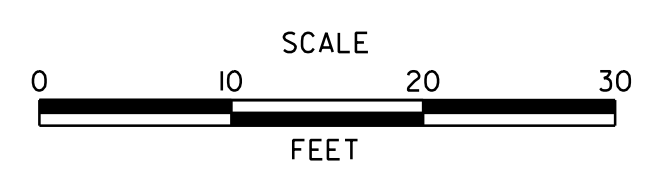

US 301
LEVELS ROAD
TO SUMMIT BRIDGE ROAD

CONTRACT	BRIDGE NO.
T20091303	DESIGNED BY: WRC
COUNTY	CHECKED BY: WAM
NEW CASTLE	

RAMP G
CROSS SECTIONS

SHEET NO.
368
TOTAL SHTS.
518



DRAFT

NOT FOR BIDDING

AUGUST 2015

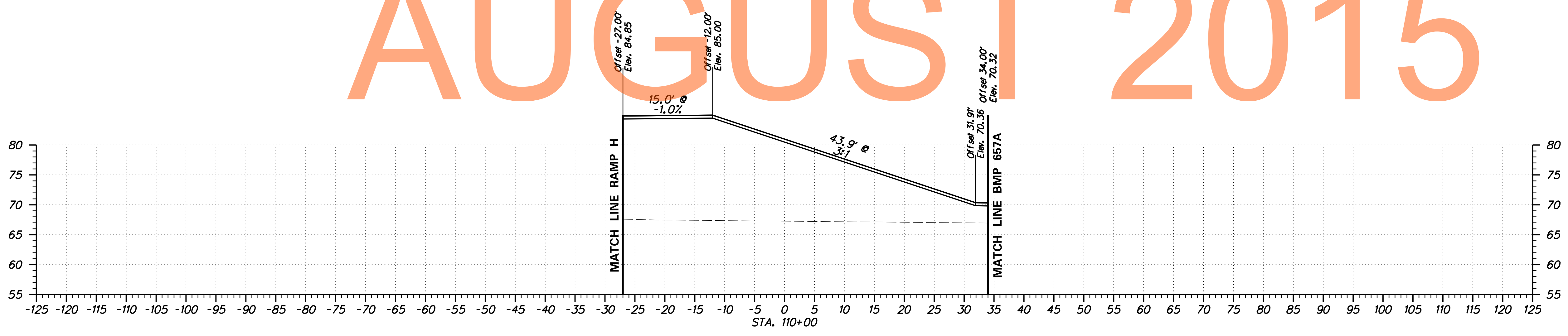

ADDENDUMS / REVISIONS	

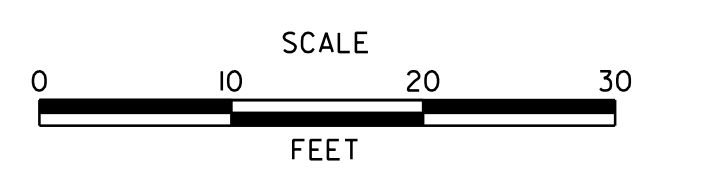

US 301
LEVELS ROAD
TO SUMMIT BRIDGE ROAD

CONTRACT	BRIDGE NO.
T200911303	DESIGNED BY: WRC
COUNTY	CHECKED BY: WAM
NEW CASTLE	

RAMP G
CROSS SECTIONS

SHEET NO.
369
TOTAL SHTS.
518

DRAFT

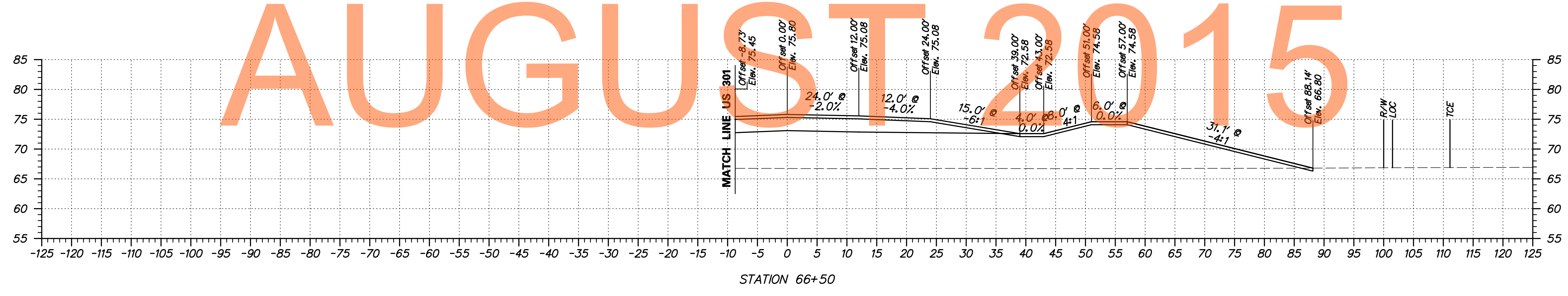
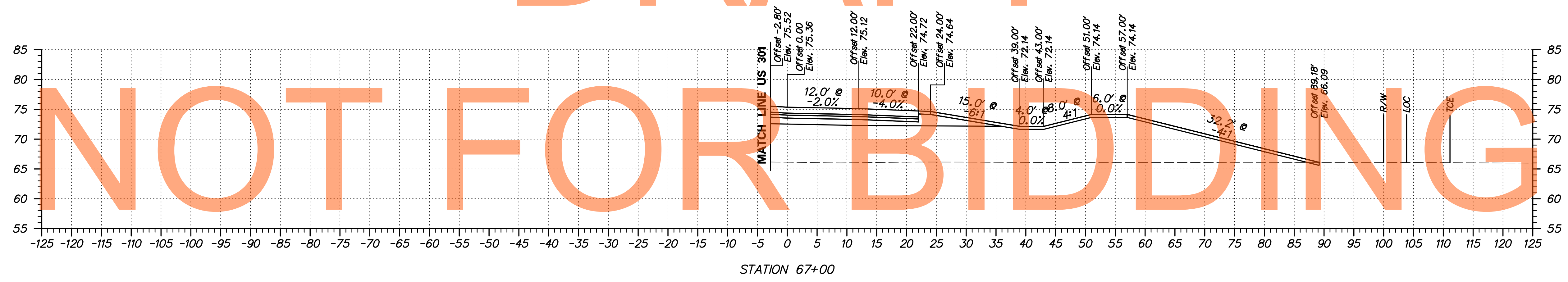
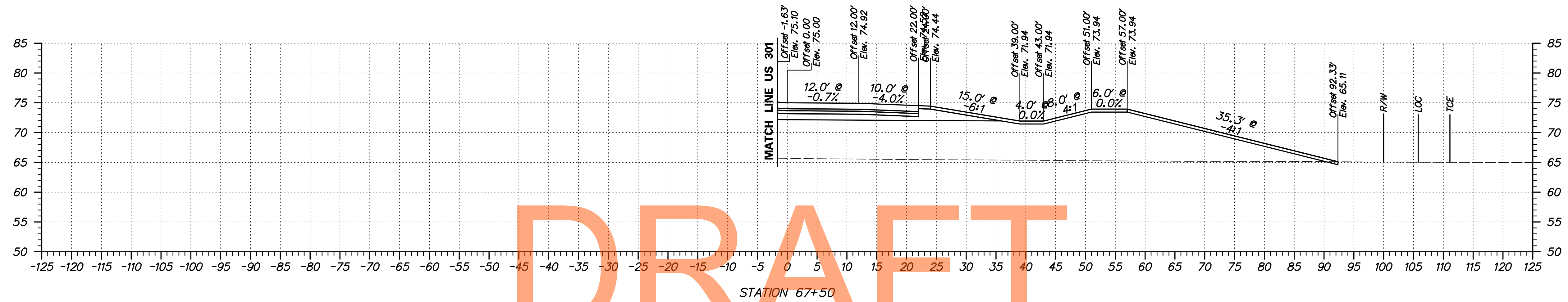

NOT FOR BIDDING

ADDENDUMS / REVISIONS	

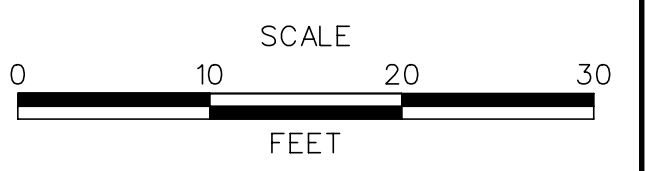

**US 301
LEVELS ROAD
TO SUMMIT BRIDGE ROAD**

CONTRACT T20091303	BRIDGE NO.	
COUNTY NEW CASTLE	DESIGNED BY:	IK
	CHECKED BY:	JH

**RAMP H
CROSS SECTIONS**

SHEET NO. 370
TOTAL SHTS. 518

S:\PROJECTS\TRANSPORTATION\JOBS-NR\NEW CASTLE\301\ROAD\T20091303\PLANS\XREFS\CPBOARD XS-2A.URS.DGN



DRAFT

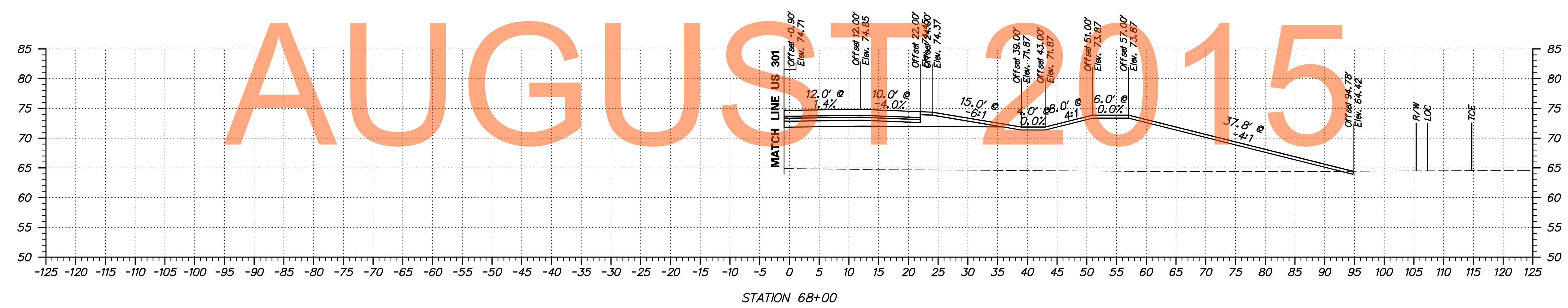
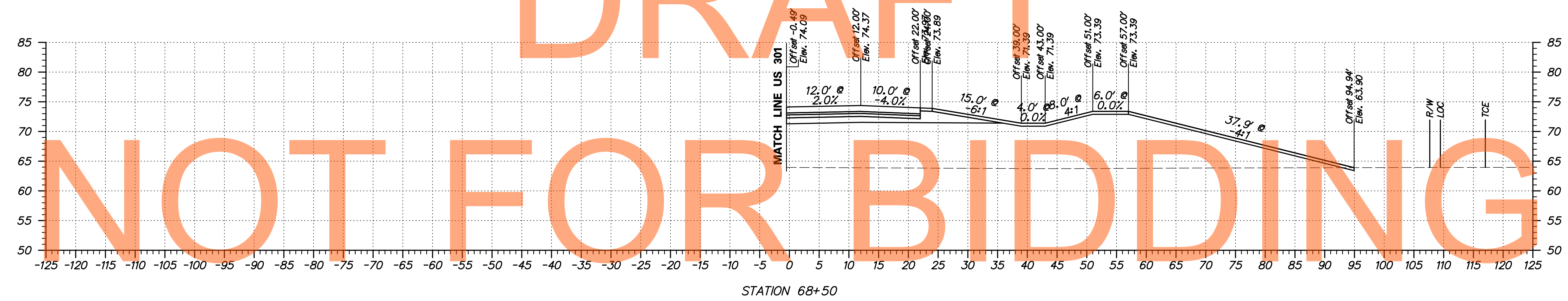

NOT FOR BIDDING

AUGUST 2015

S:\PROJECTS\TRANSPORTATION\JOBS-NR\NEW CASTLE\301\ROAD\T20091303\PLANS\REFS\CPBOARD_XS-2A_URS.DGN



ADDENDUMS / REVISIONS	

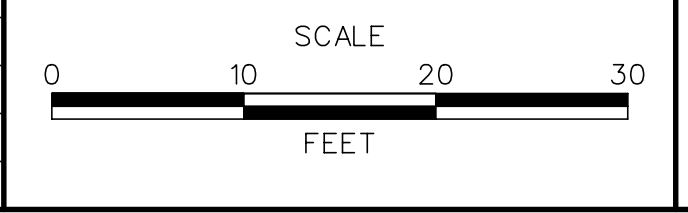

**US 301
LEVELS ROAD
TO SUMMIT BRIDGE ROAD**

CONTRACT	BRIDGE NO.	
T20091303	DESIGNED BY:	IK
COUNTY	CHECKED BY:	JH
NEW CASTLE		

**RAMP H
CROSS SECTIONS**

SHEET NO.	371
TOTAL SHTS.	518

DRAFT

NOT FOR BIDDING

AUGUST 2015

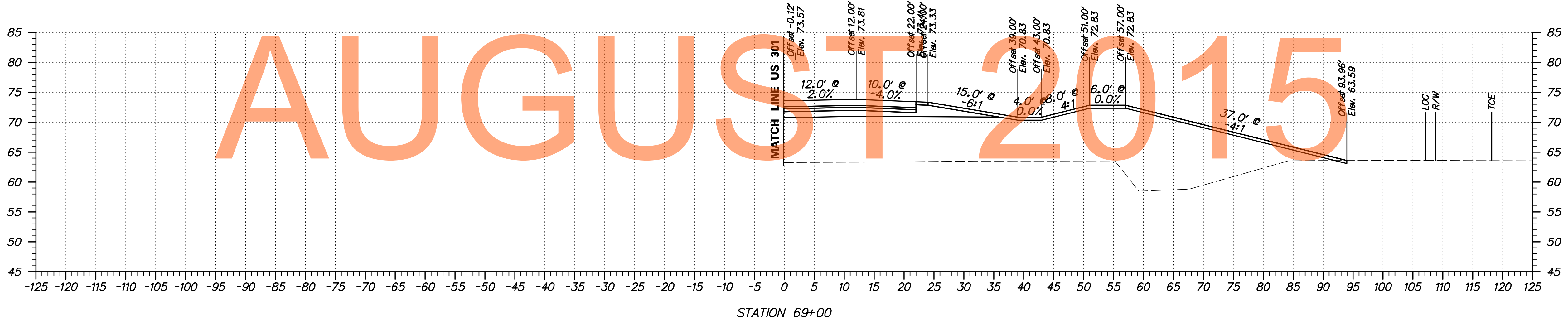

S:\PROJECTS\TRANSPORTATION\JOBS-NR\NEW CASTLE\301\ROAD\T20091303\PLANS\REFS\CPBOARD XS_2A_URS.DGN



ADDENDUMS / REVISIONS	

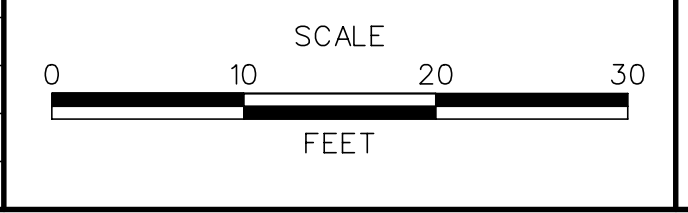

**US 301
LEVELS ROAD
TO SUMMIT BRIDGE ROAD**

CONTRACT	BRIDGE NO.	
T20091303	DESIGNED BY:	IK
COUNTY	CHECKED BY:	JH
NEW CASTLE		

**RAMP H
CROSS SECTIONS**

SHEET NO.	372
TOTAL SHTS.	578

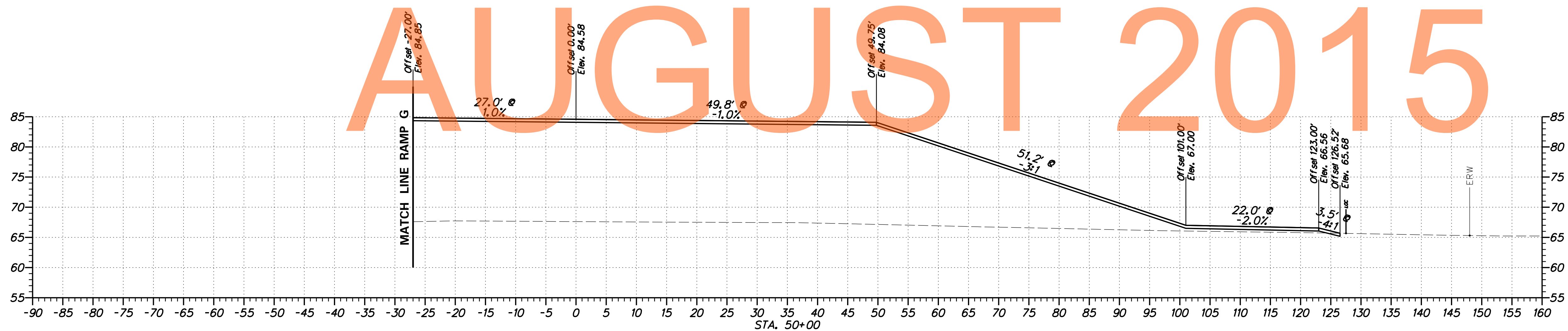
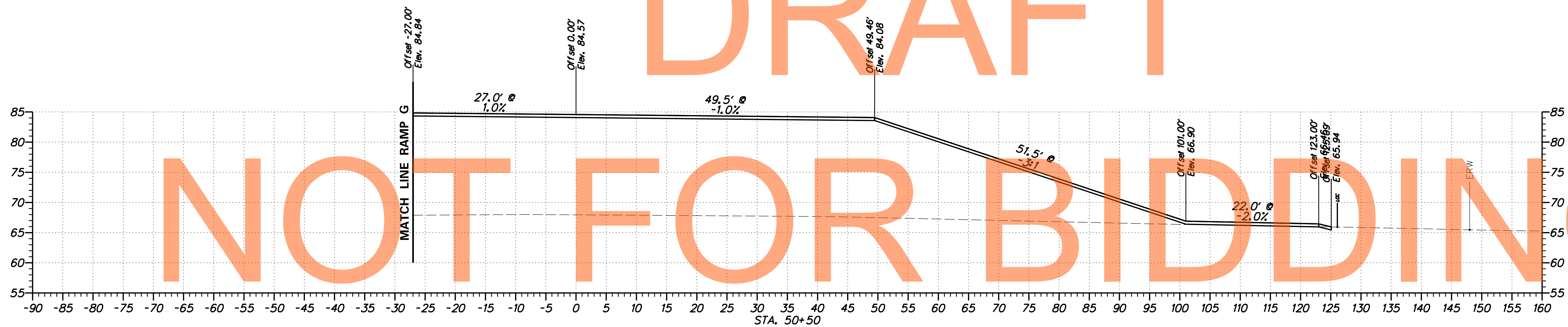
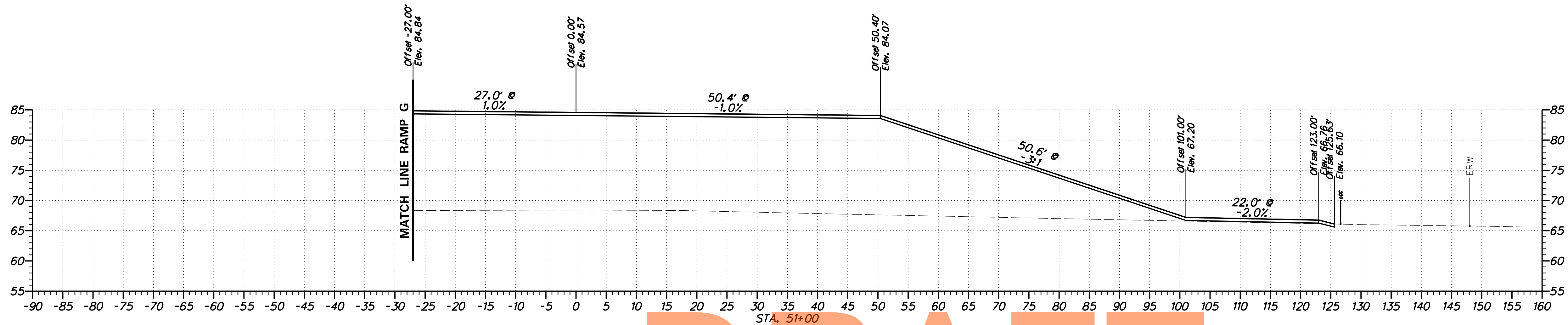

DRAFT
NOT FOR BIDDING
AUGUST 2015

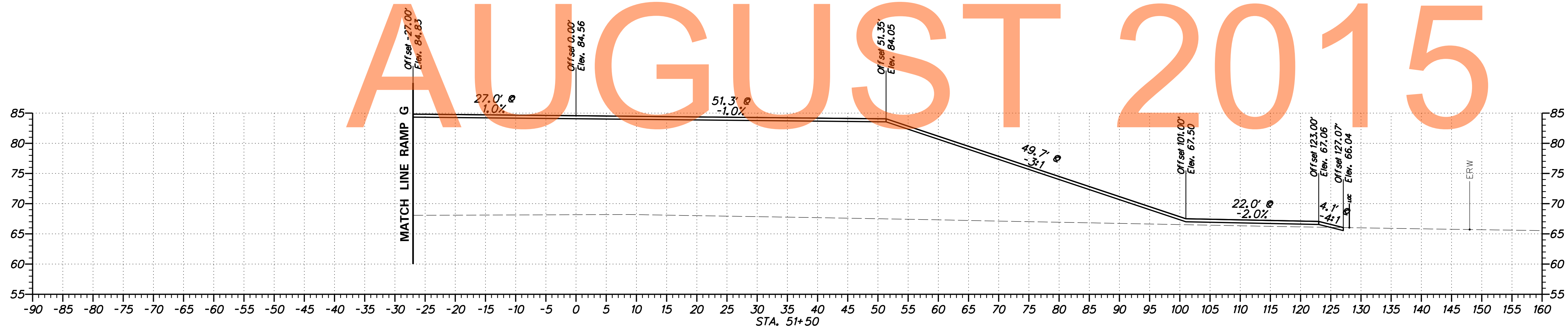
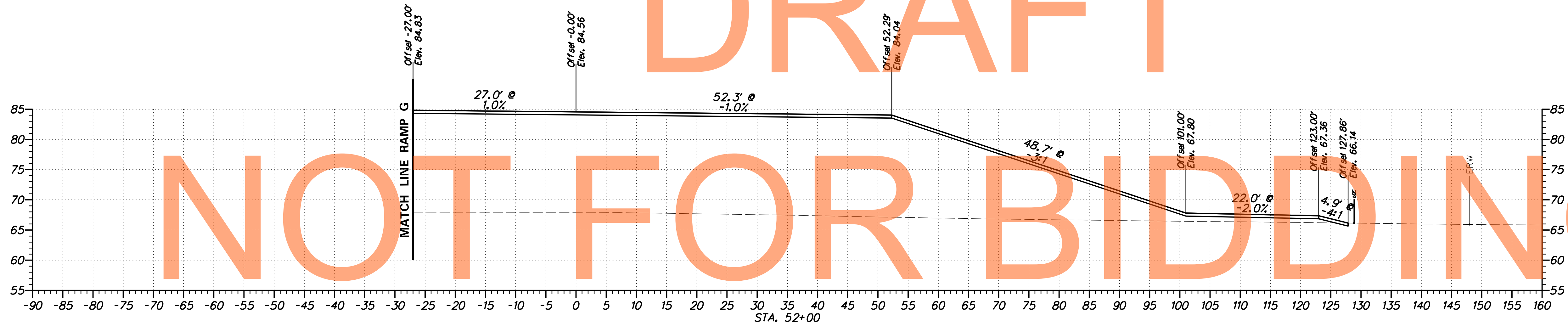
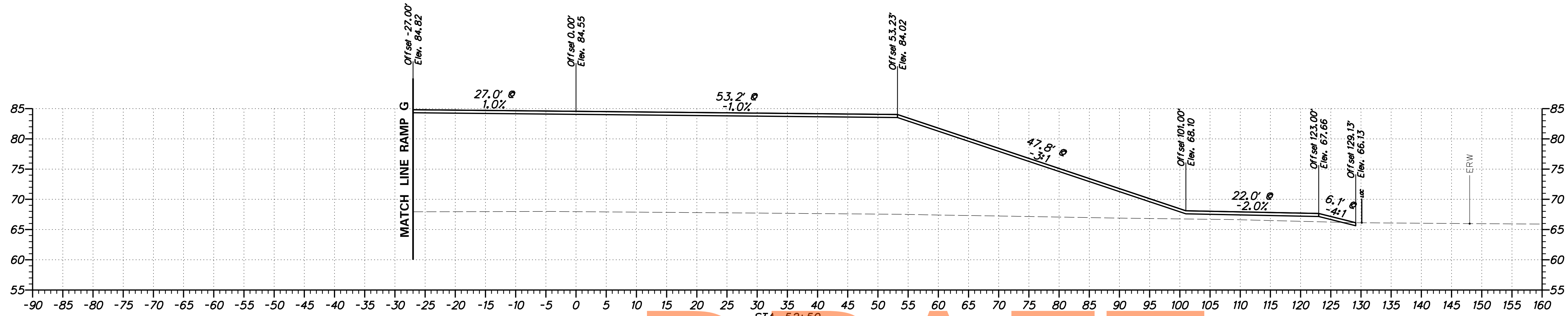

DRAFT
 NOT FOR BIDDING
 AUGUST 2015

ADDENDUMS / REVISIONS	

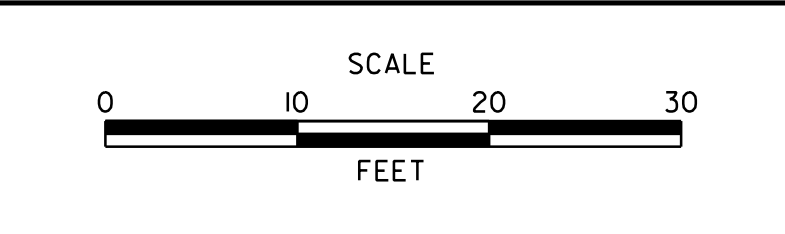

CONTRACT	BRIDGE NO.
T20091303	DESIGNED BY: WRC
COUNTY	CHECKED BY: WAM
NEW CASTLE	

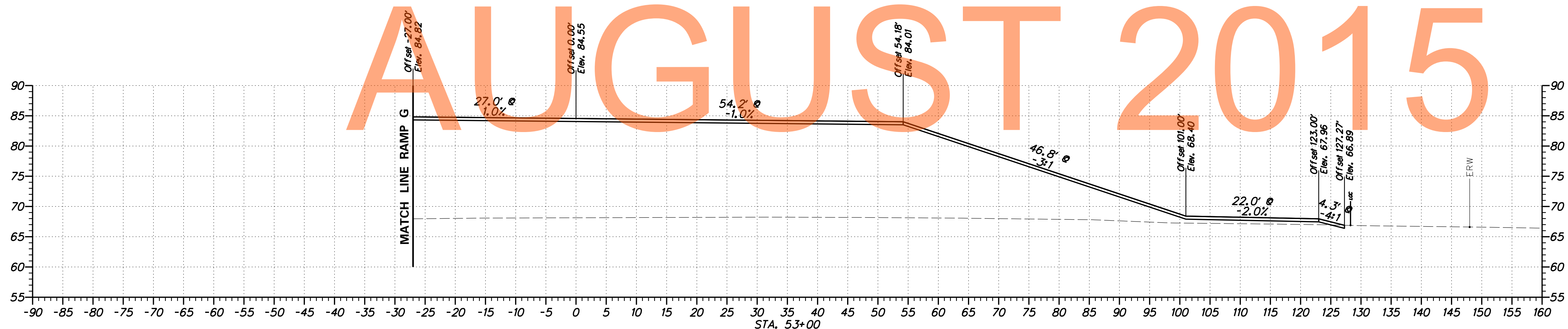
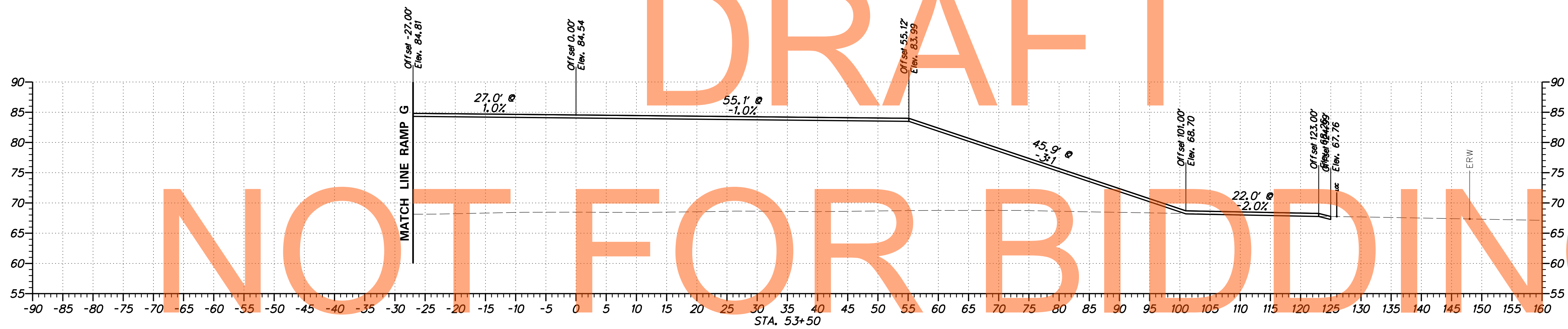
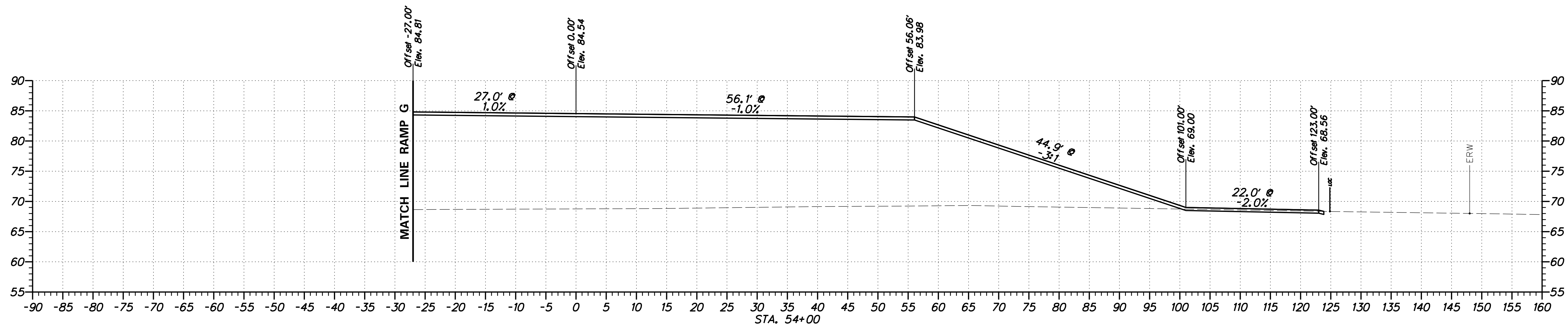

DRAFT
NOT FOR BIDDING
AUGUST 2015

ADDENDUMS / REVISIONS	

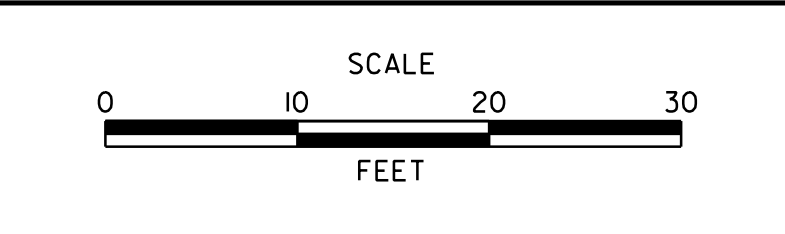

**US 301
LEVELS ROAD
TO SUMMIT BRIDGE ROAD**

CONTRACT T200911303	BRIDGE NO.
COUNTY NEW CASTLE	DESIGNED BY: WRC CHECKED BY: WAM

**RAMP H
CROSS SECTIONS**

SHEET NO. 375
TOTAL SHTS. 518