

DRAFT

NOT FOR BIDDING

AUGUST 2015

ADDENDUMS / REVISIONS	

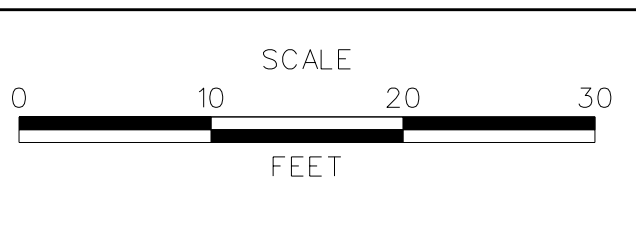

CONTRACT T200811301	BRIDGE NO. 
COUNTY NEW CASTLE	DESIGNED BY: PB CHECKED BY: RK

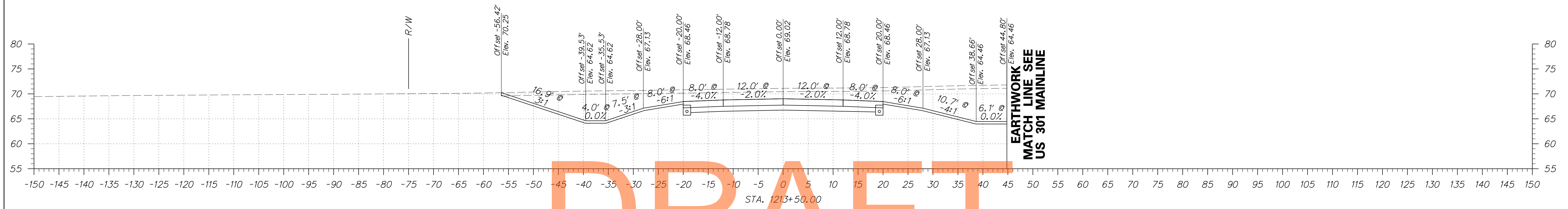

DRAFT

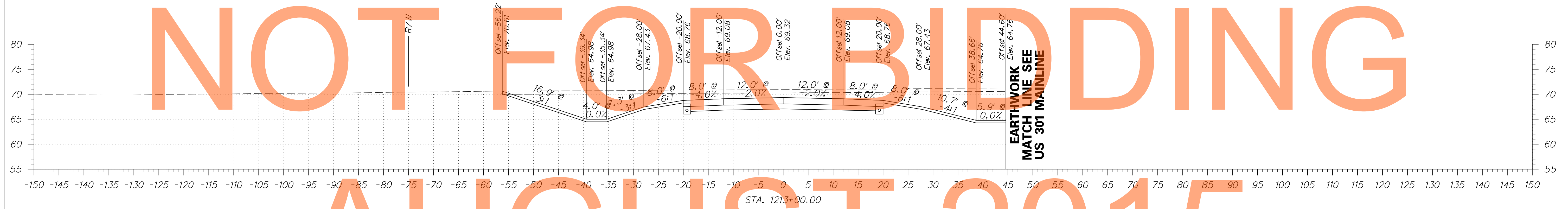

NOT FOR BIDDING

AUGUST 2015

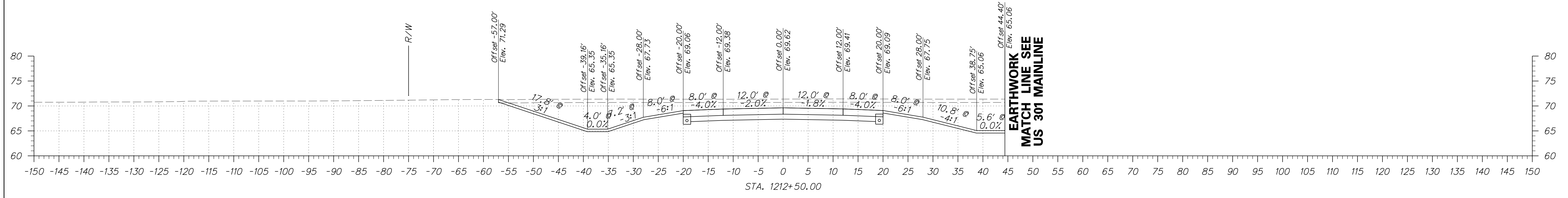

ADDENDUMS / REVISIONS	

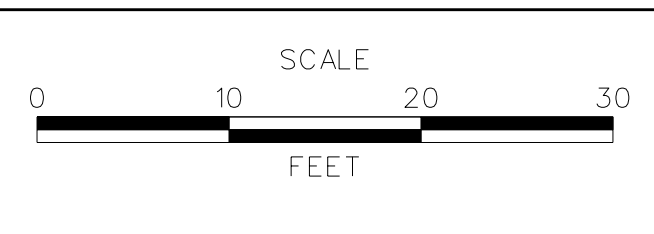

**US 301  
MARYLAND STATE LINE  
TO LEVELS ROAD**

CONTRACT T200811301	BRIDGE NO. 
COUNTY NEW CASTLE	DESIGNED BY: PB CHECKED BY: RK

<b>CROSS SECTIONS WARWICK ROAD</b>	SHEET NO. 202
	TOTAL SHTS. 539

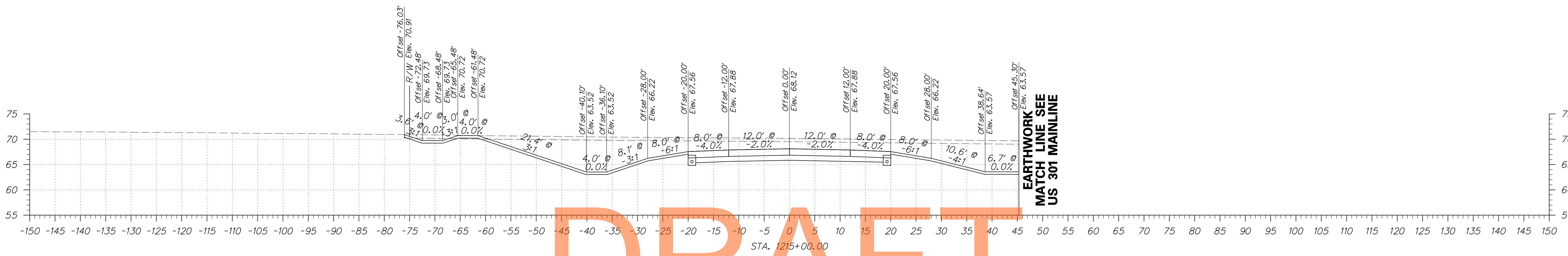

DRAFT

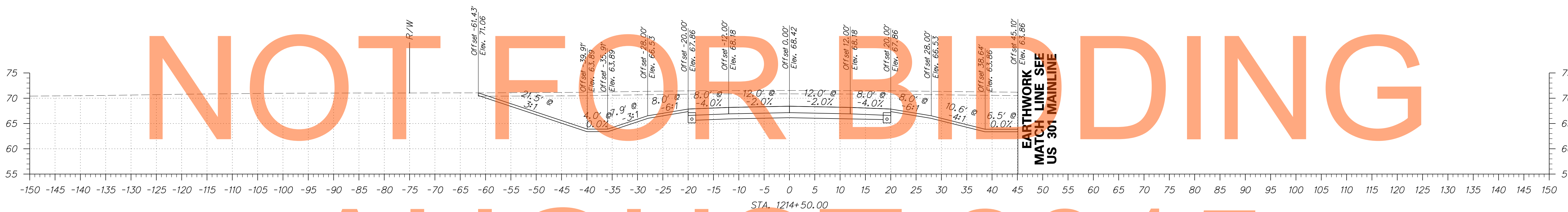

AUGUST 2015

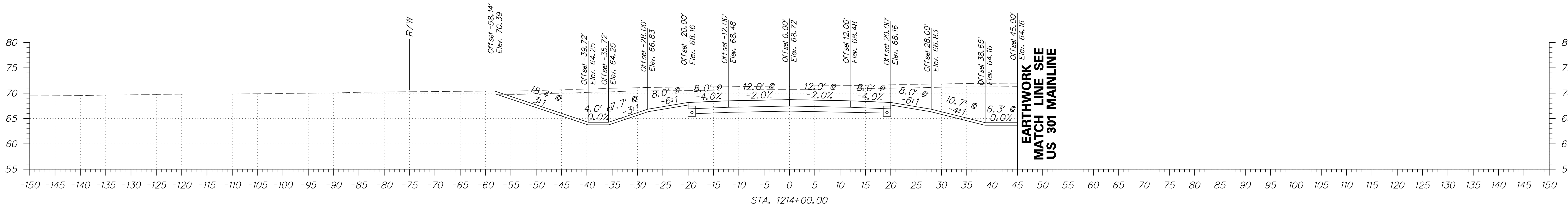

ADDENDUMS / REVISIONS	

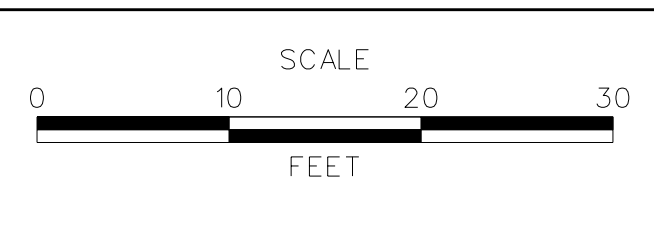

US 301  
MARYLAND STATE LINE  
TO LEVELS ROAD

CONTRACT T200811301	BRIDGE NO.
COUNTY NEW CASTLE	DESIGNED BY: PB CHECKED BY: RK

CROSS SECTIONS WARWICK ROAD	SHEET NO. 203
	TOTAL SHTS. 539

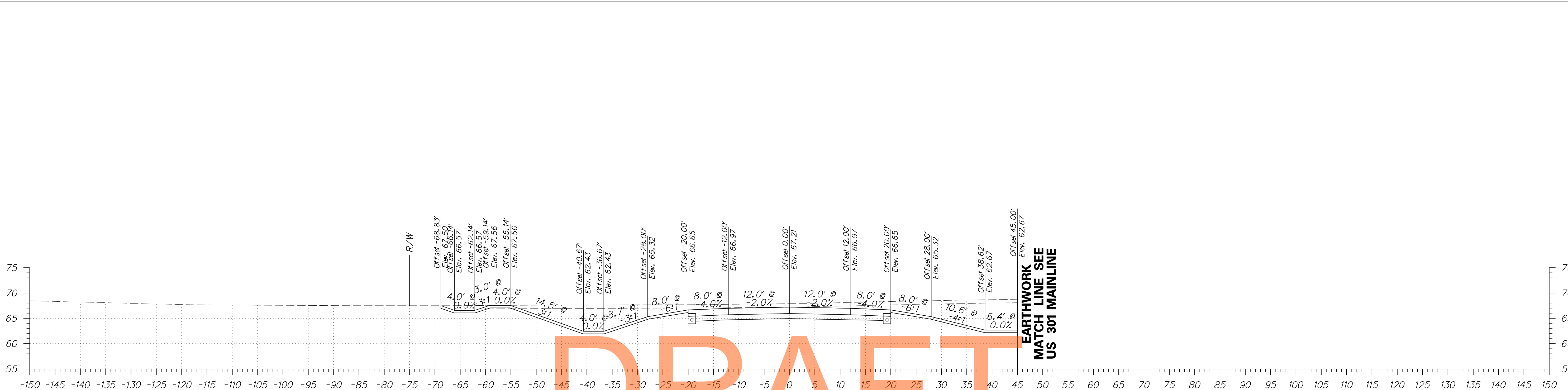

**DRAFT**

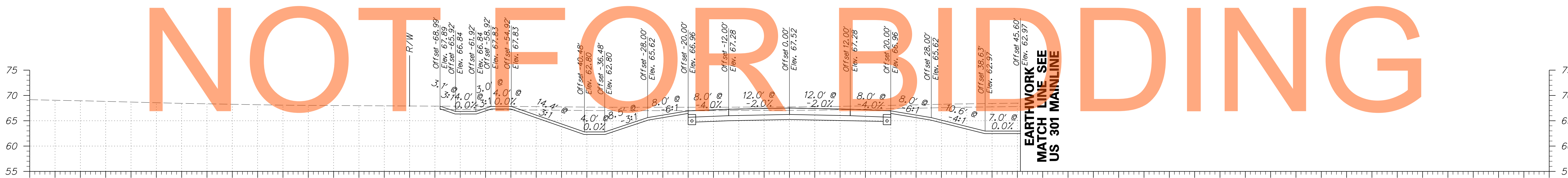

**AUGUST 2015**

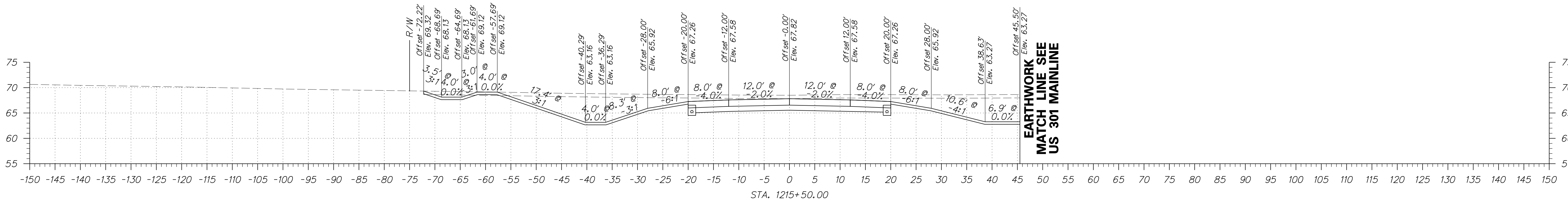

ADDENDUMS / REVISIONS

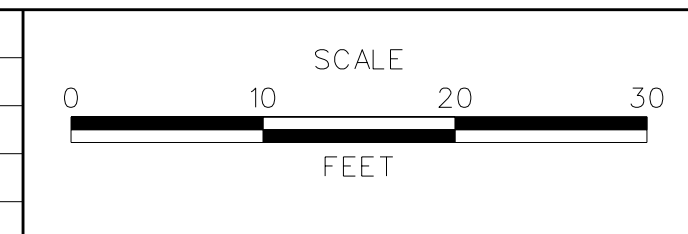

**US 301  
MARYLAND STATE LINE  
TO LEVELS ROAD**

CONTRACT T200811301	BRIDGE NO.
COUNTY NEW CASTLE	DESIGNED BY: PB CHECKED BY: RK

**CROSS SECTIONS  
WARWICK ROAD**

SHEET NO. 204
TOTAL SHTS. 539

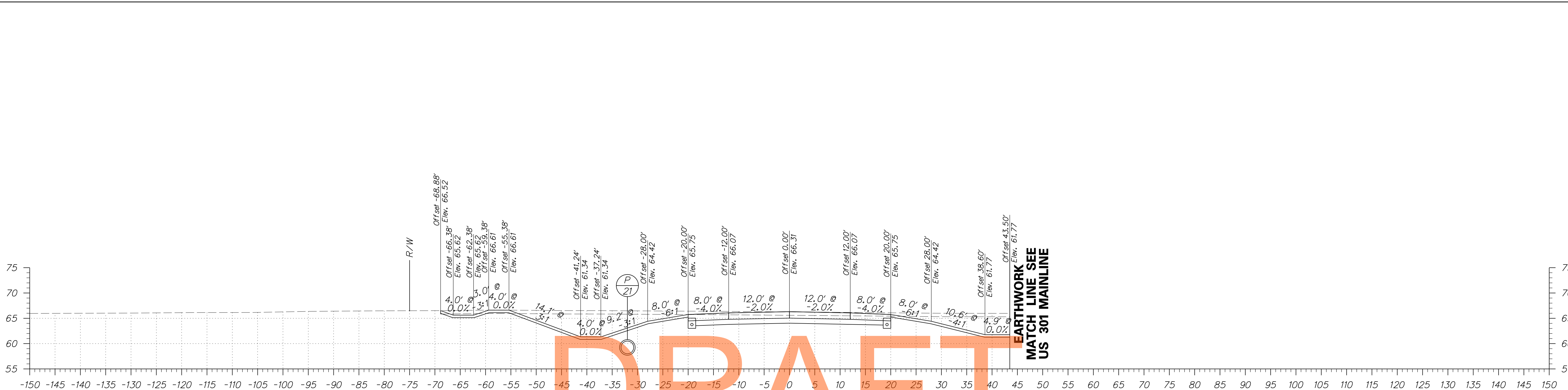

DRAFT

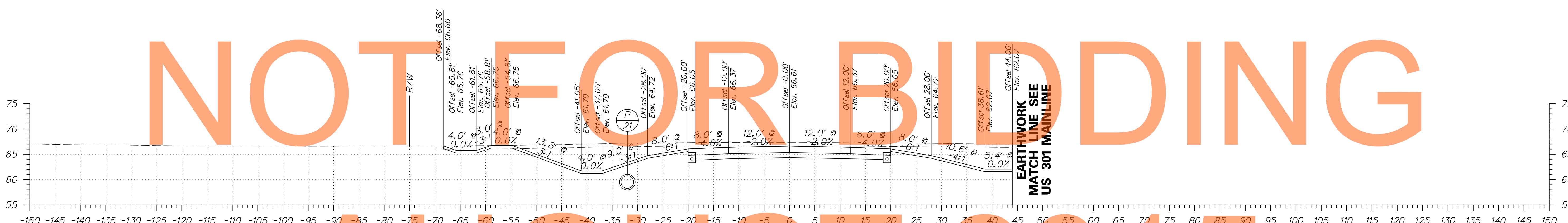

NOT FOR BIDDING

AUGUST 2015

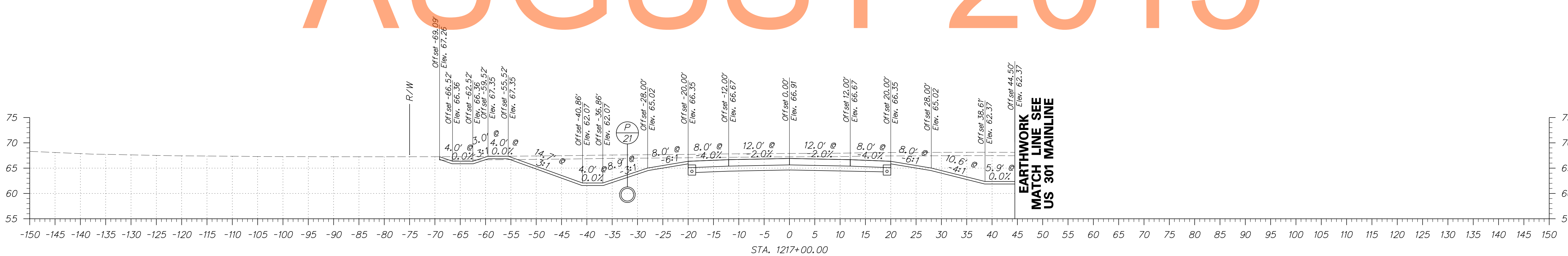

ADDENDUMS / REVISIONS	

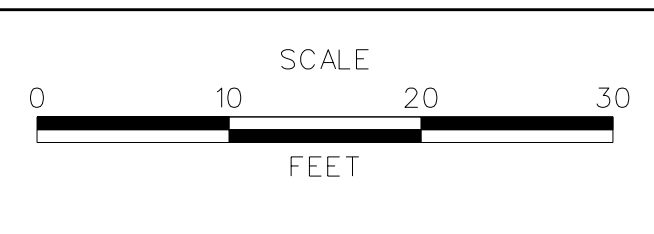

**US 301**  
**MARYLAND STATE LINE**  
**TO LEVELS ROAD**

CONTRACT T200811301	BRIDGE NO. 
COUNTY NEW CASTLE	DESIGNED BY: PB CHECKED BY: RK

**CROSS SECTIONS**  
**WARWICK ROAD**

SHEET NO. 205
TOTAL SHTS. 539

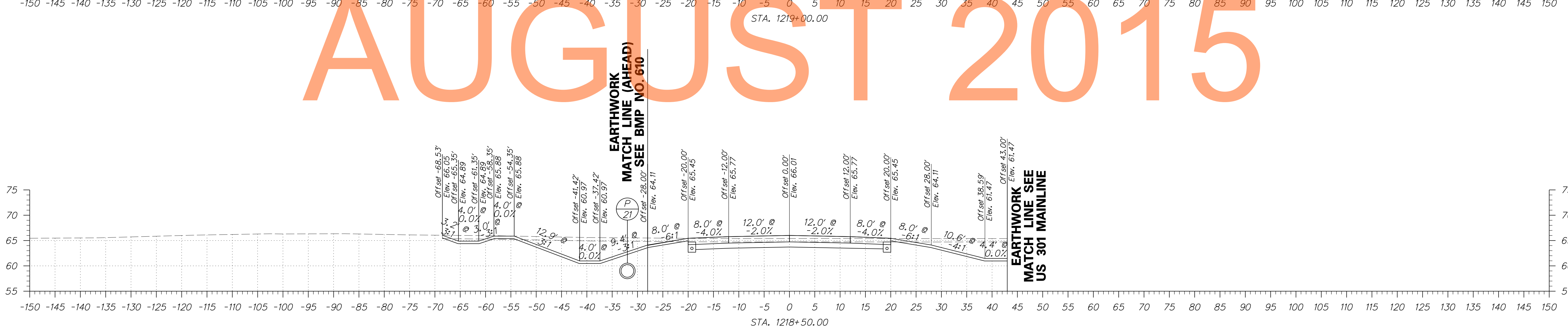
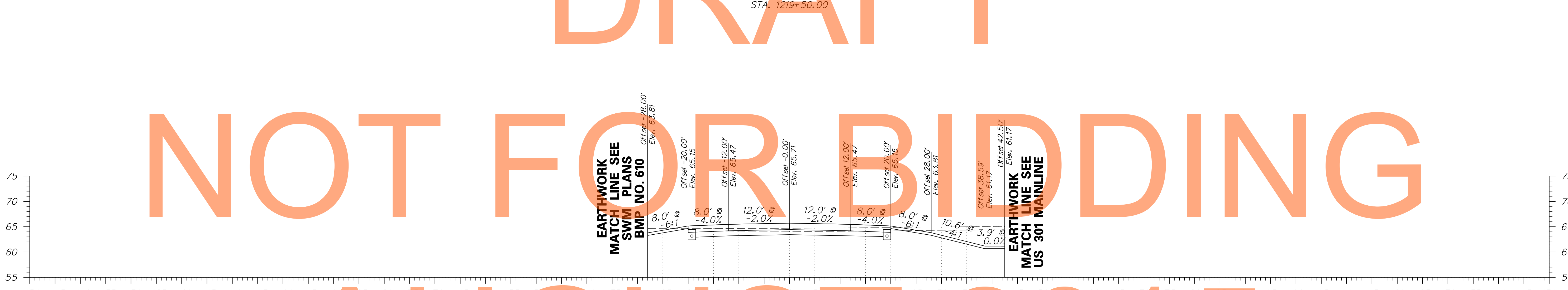
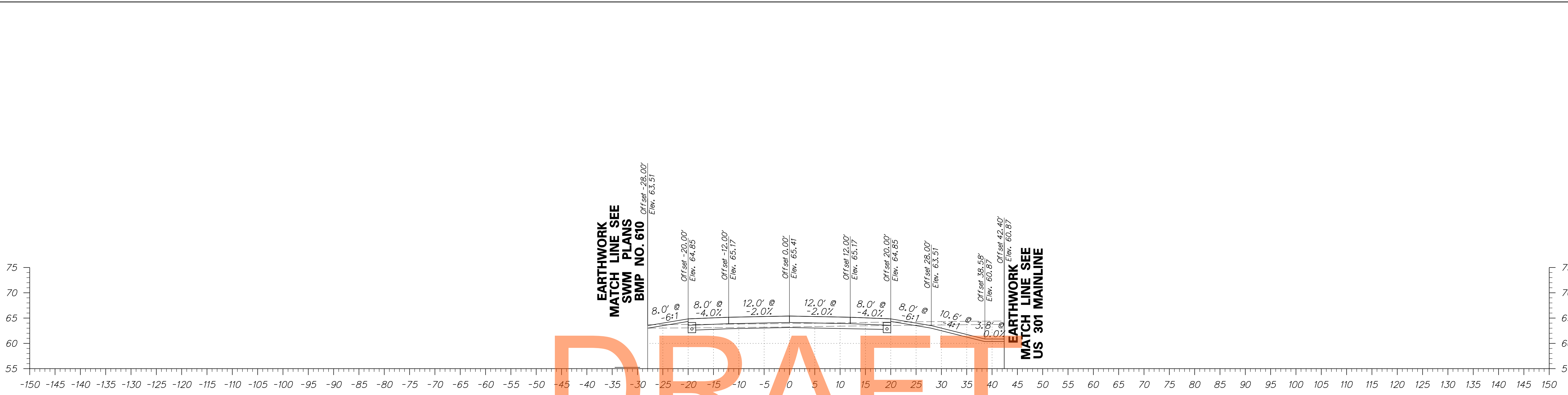

ADDENDUMS / REVISIONS

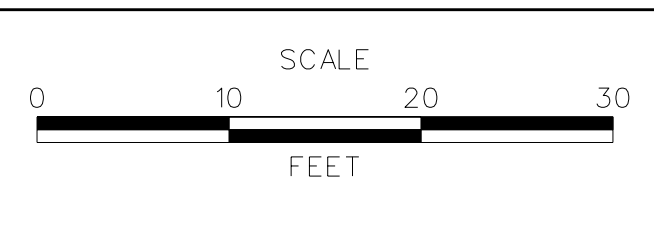

**US 301 MARYLAND STATE LINE TO LEVELS ROAD**

CONTRACT T200811301	BRIDGE NO.
COUNTY NEW CASTLE	DESIGNED BY: PB
	CHECKED BY: RK

<b>CROSS SECTIONS WARWICK ROAD</b>
SHEET NO. 206
TOTAL SHTS. 539

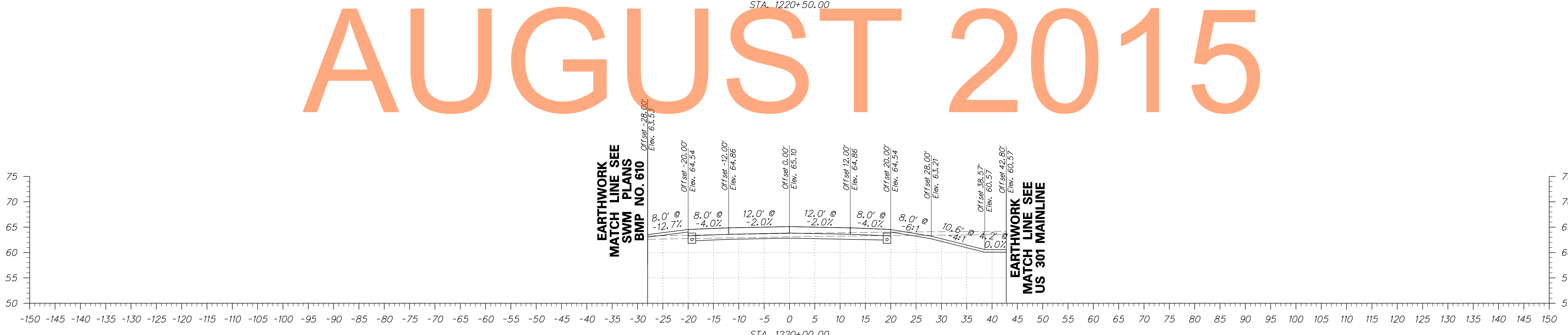
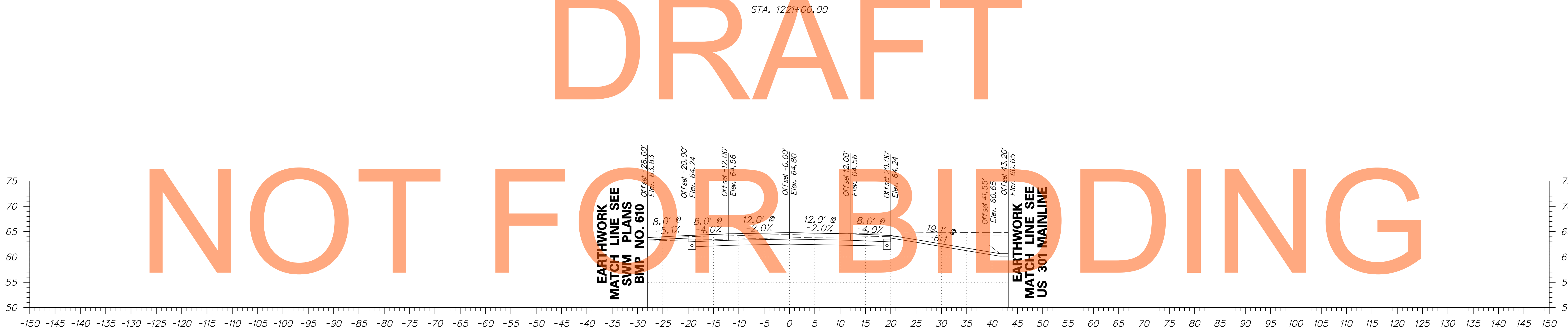
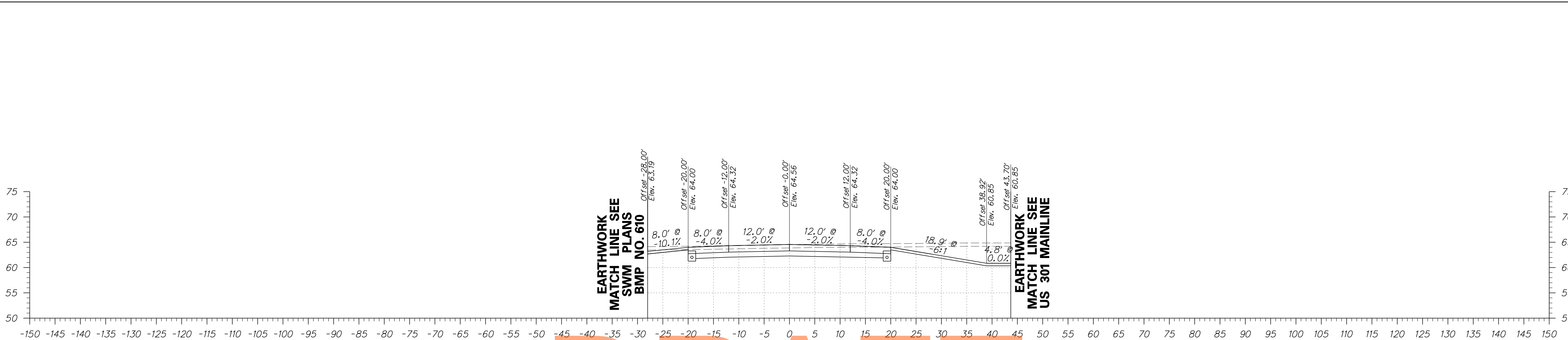

DRAFT

NOT FOR BIDDING

AUGUST 2015

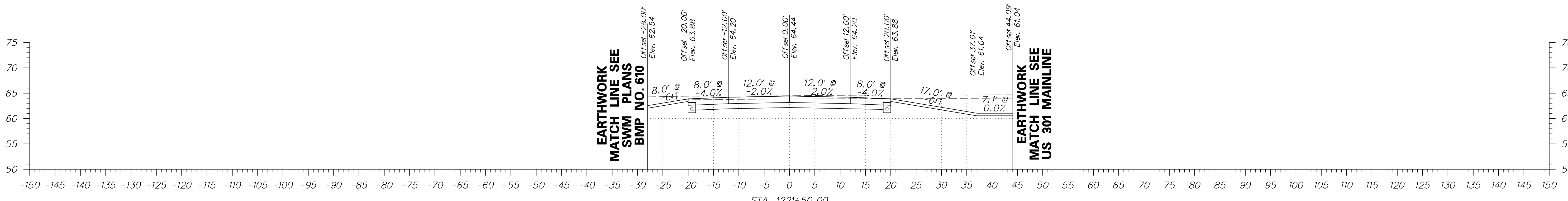
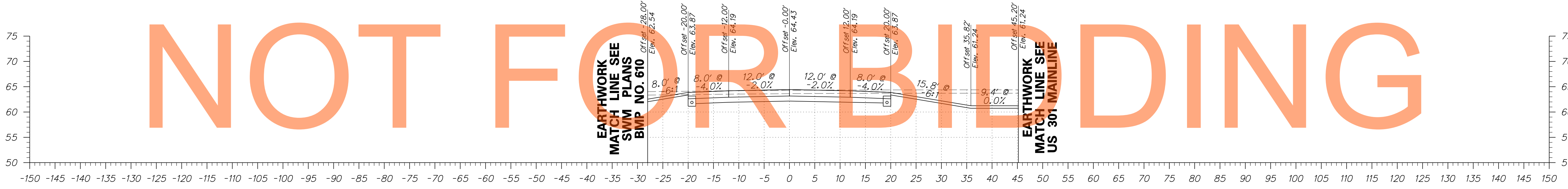
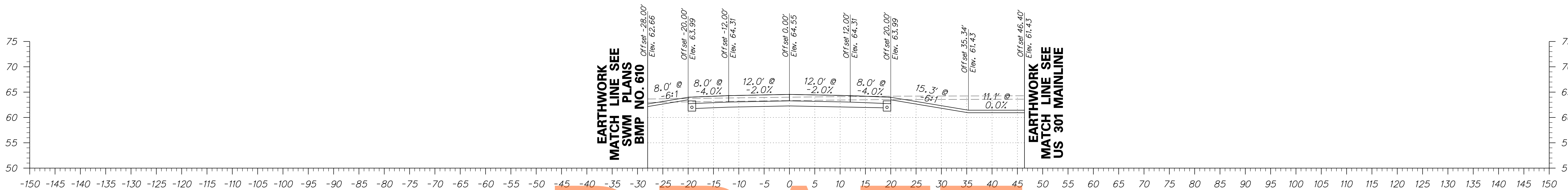

DRAFT

NOT FOR BIDDING

AUGUST 2015



ADDENDUMS / REVISIONS	

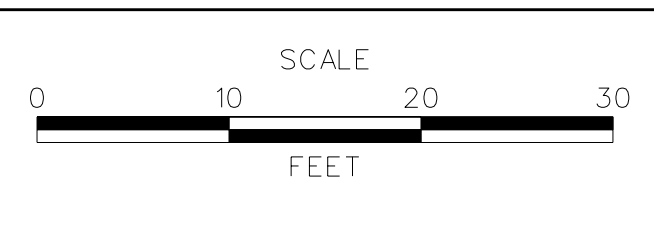

**US 301  
MARYLAND STATE LINE  
TO LEVELS ROAD**

CONTRACT T200811301	BRIDGE NO. 
COUNTY NEW CASTLE	DESIGNED BY: PB CHECKED BY: RK

<b>CROSS SECTIONS WARWICK ROAD</b>	SHEET NO. 208
	TOTAL SHTS. 539



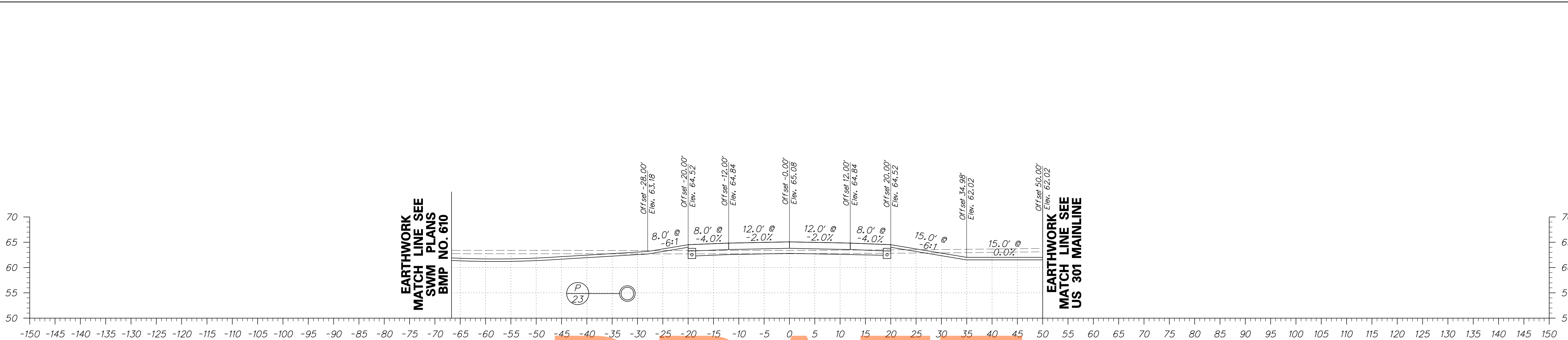

DRAFT

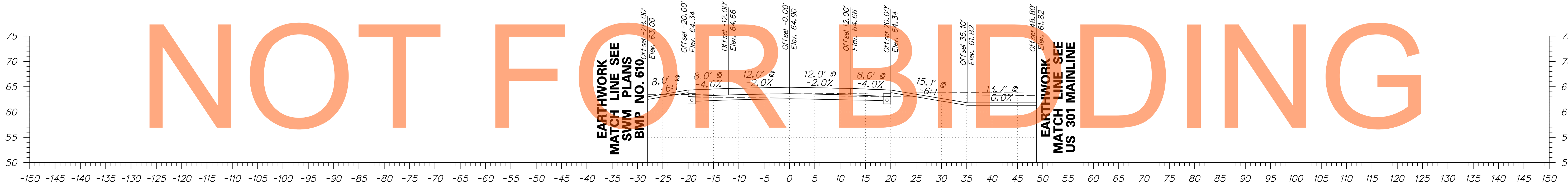

NOT FOR BIDDING

AUGUST 2015

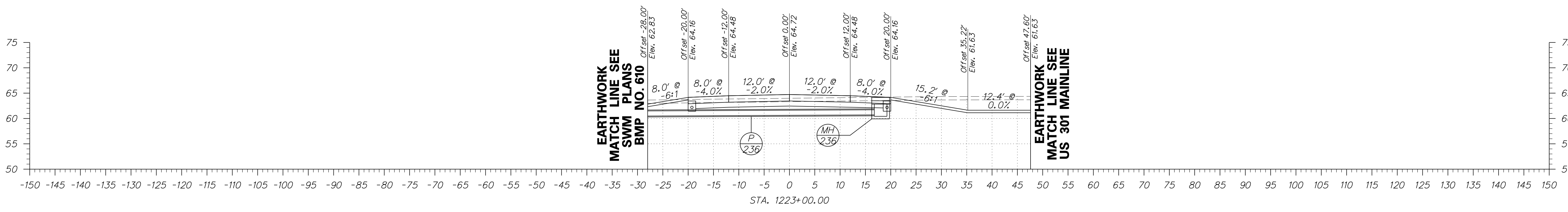

ADDENDUMS / REVISIONS	

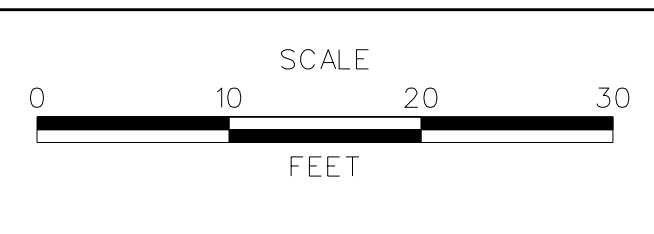

**US 301  
MARYLAND STATE LINE  
TO LEVELS ROAD**

CONTRACT T200811301	BRIDGE NO. 
COUNTY NEW CASTLE	DESIGNED BY: PB CHECKED BY: RK

<b>CROSS SECTIONS WARWICK ROAD</b>	SHEET NO. 209
	TOTAL SHTS. 539

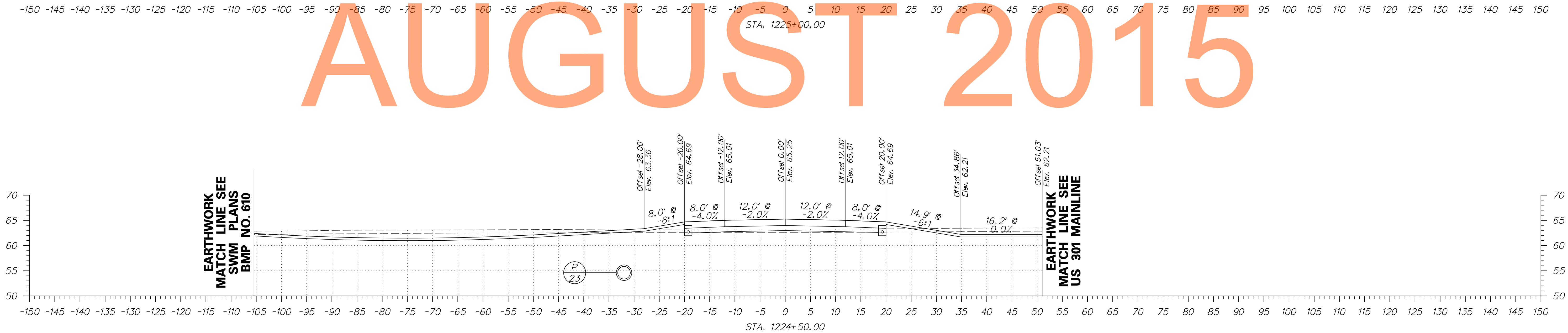
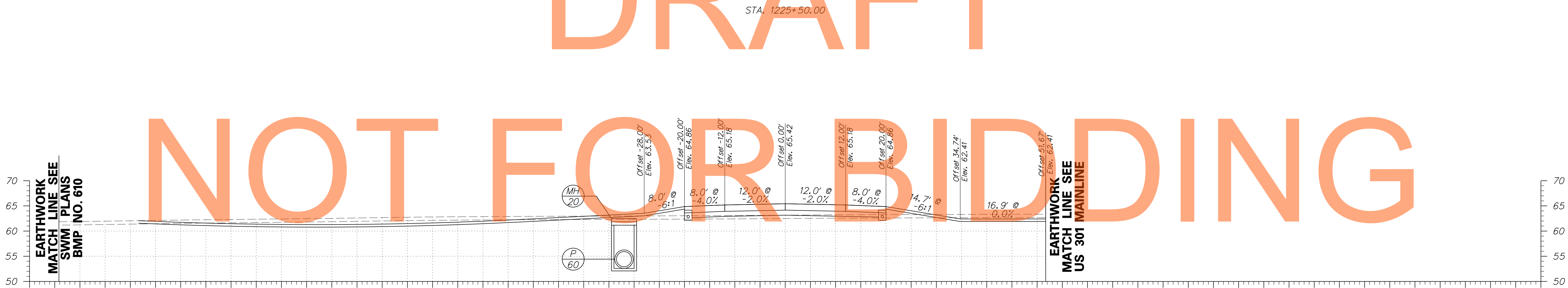
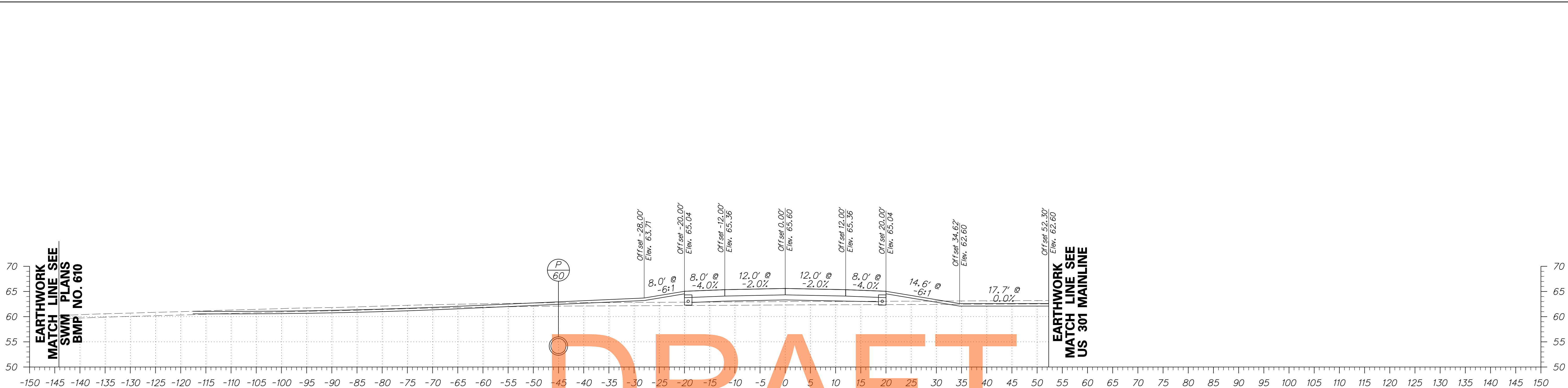

DRAFT

NOT FOR BIDDING

AUGUST 2015

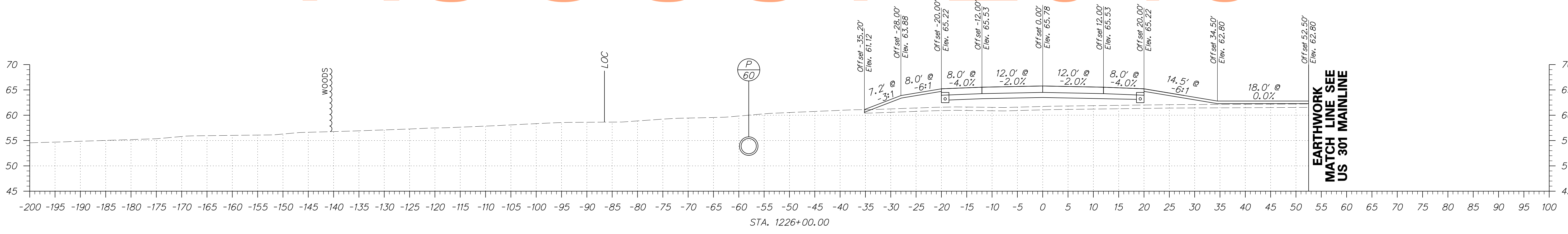
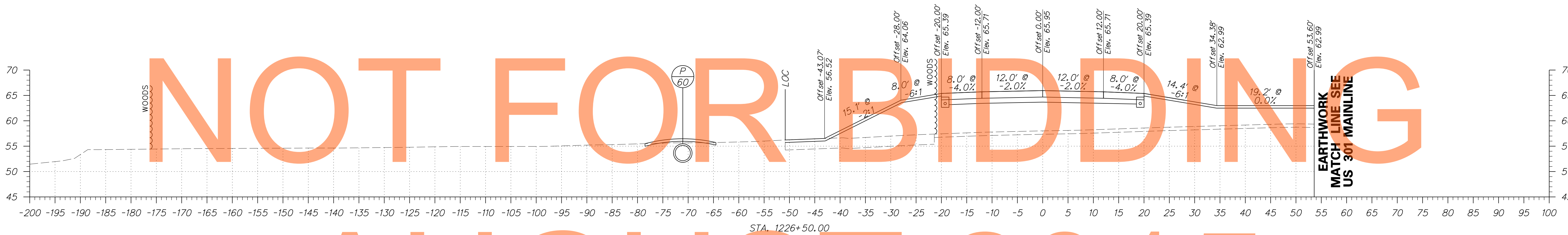
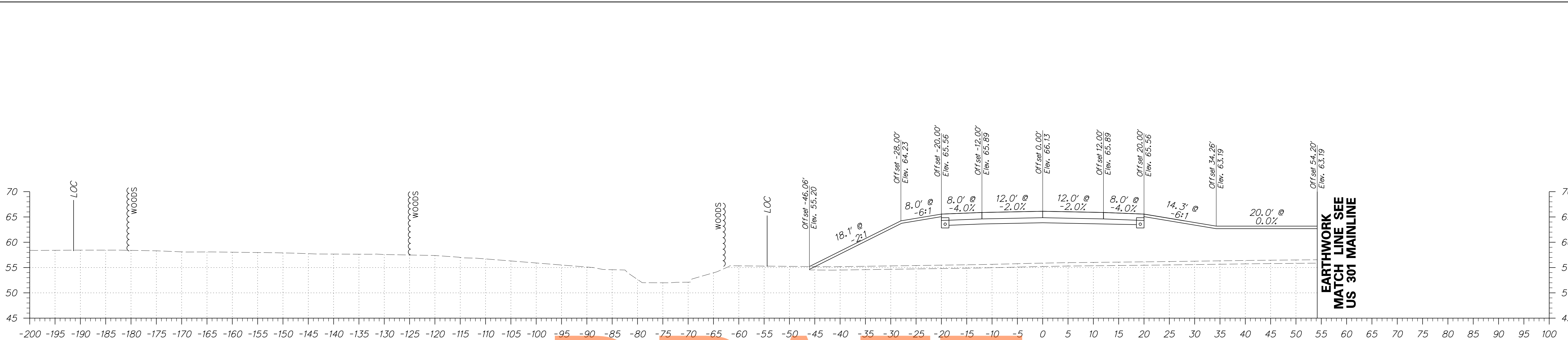

DRAFT

NOT FOR BIDDING

AUGUST 2015

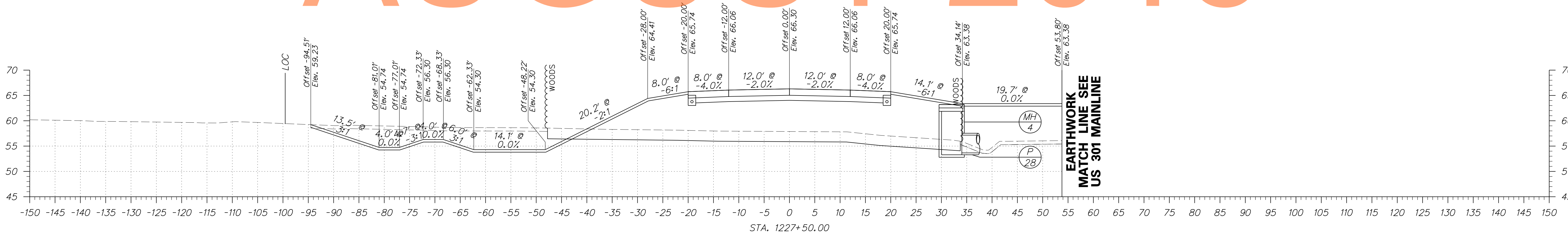
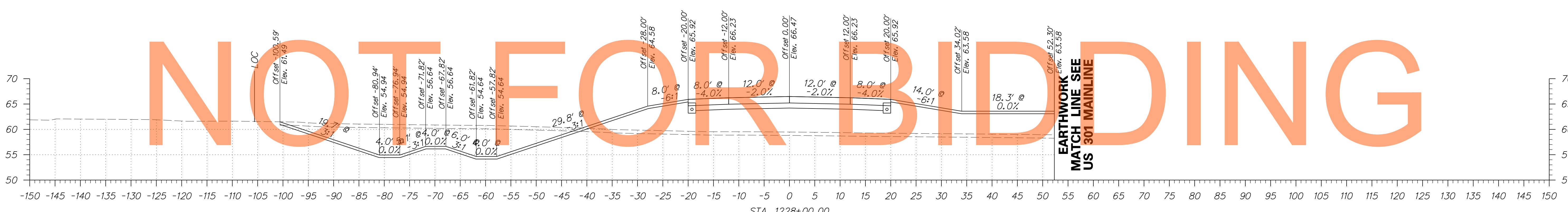
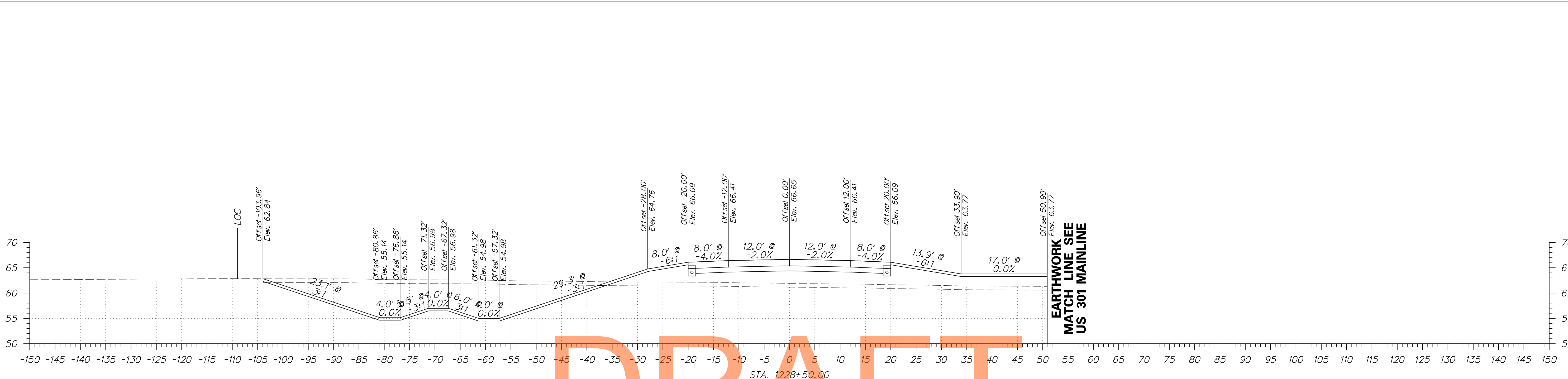

DRAFT

NOT FOR BIDDING

AUGUST 2015

ADDENDUMS / REVISIONS	

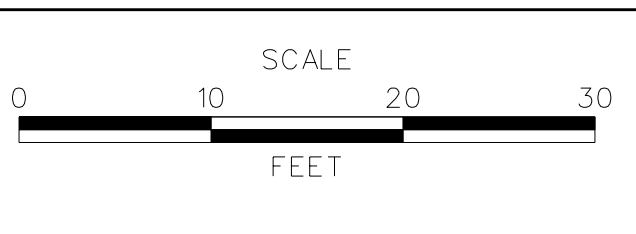

CONTRACT T200811301	BRIDGE NO.
COUNTY NEW CASTLE	DESIGNED BY: PB
	CHECKED BY: RK

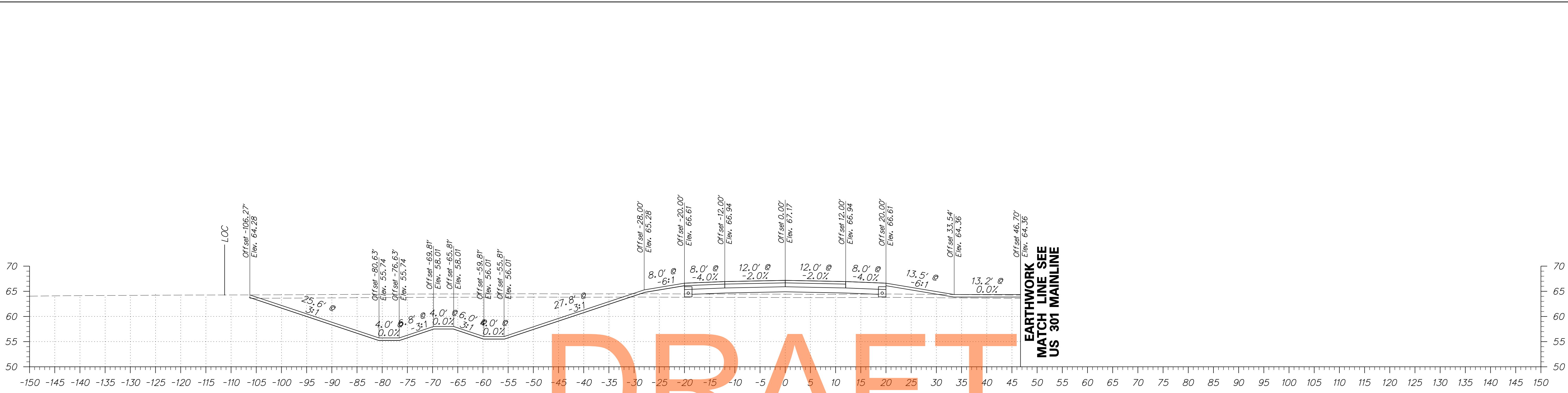

DRAFT

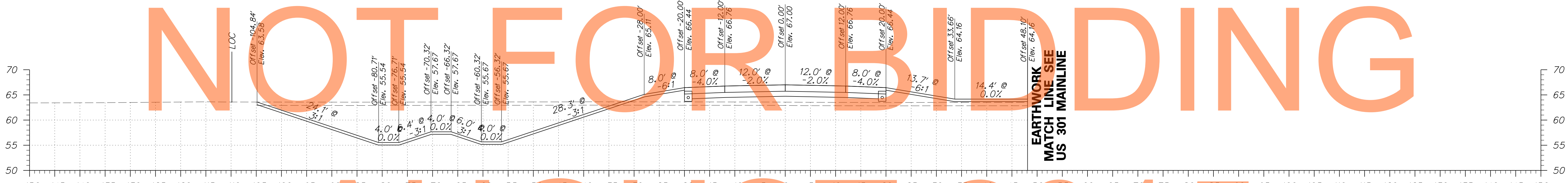

AUGUST 2015

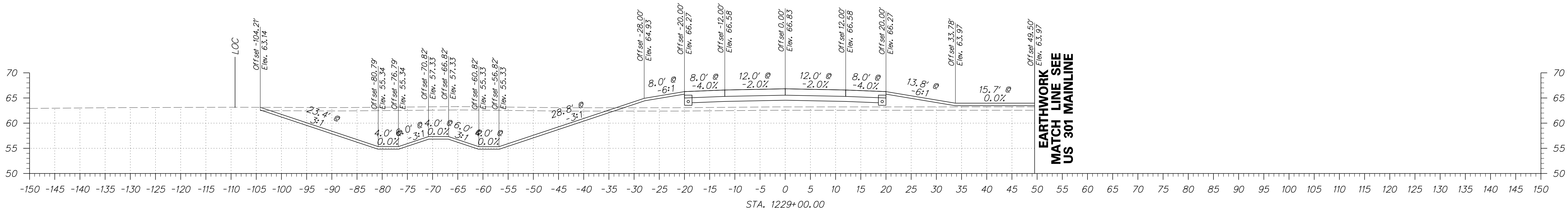

ADDENDUMS / REVISIONS	

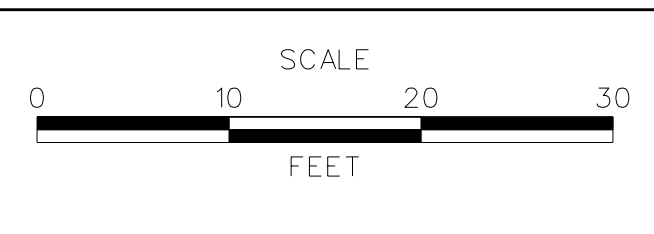

**US 301  
MARYLAND STATE LINE  
TO LEVELS ROAD**

CONTRACT T200811301	BRIDGE NO. 
COUNTY NEW CASTLE	DESIGNED BY: PB CHECKED BY: RK

<b>CROSS SECTIONS WARWICK ROAD</b>	SHEET NO. 213
	TOTAL SHTS. 539

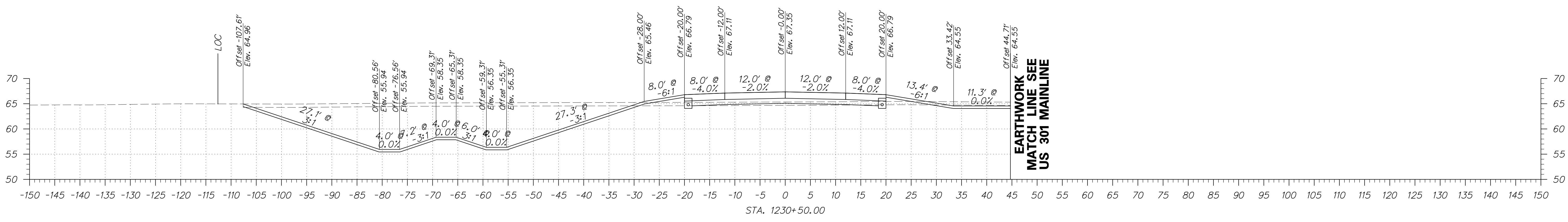
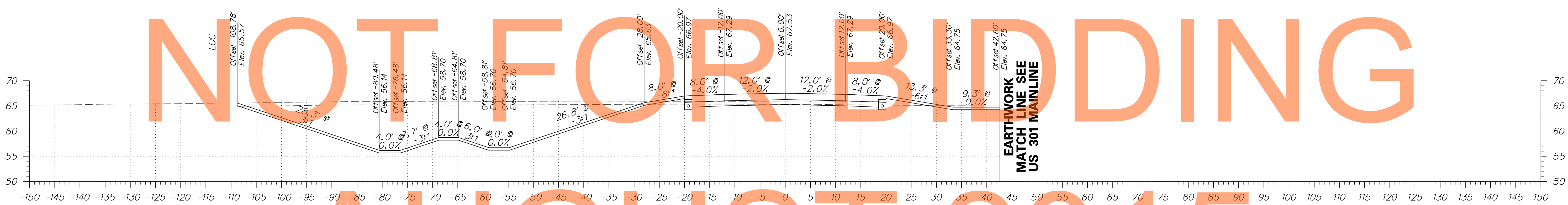
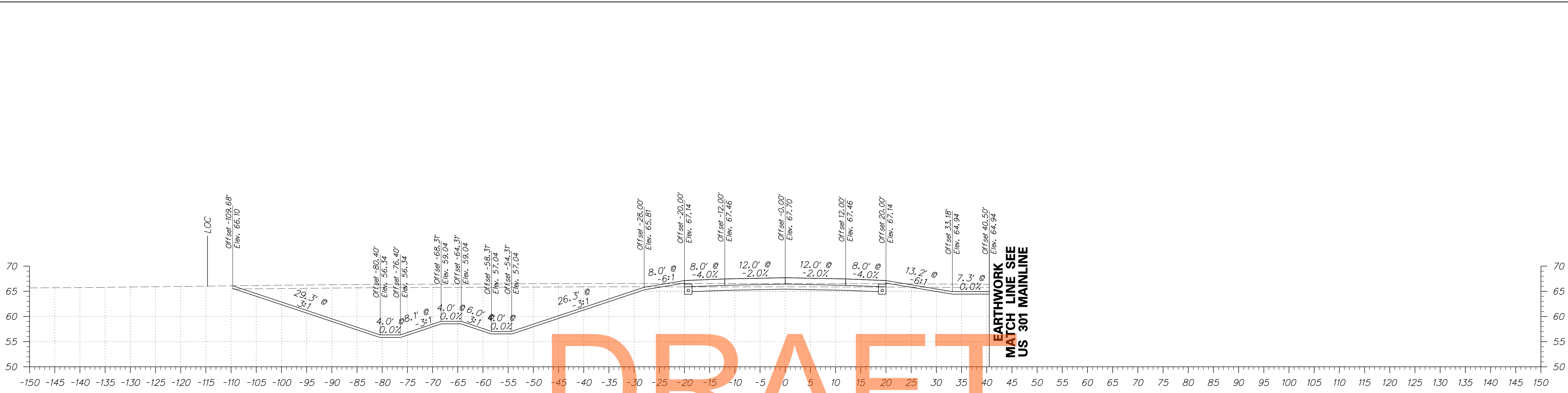

DRAFT

NOT FOR BIDDING

AUGUST 2015

ADDENDUMS / REVISIONS	

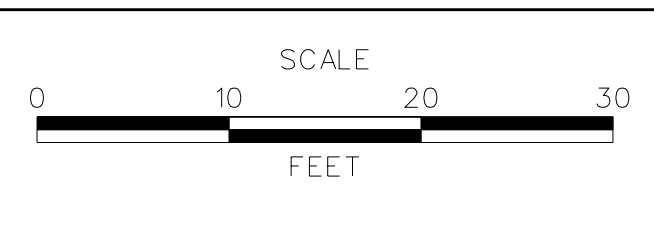

**US 301**  
**MARYLAND STATE LINE**  
**TO LEVELS ROAD**

CONTRACT T200811301	BRIDGE NO. 
COUNTY NEW CASTLE	DESIGNED BY: PB CHECKED BY: RK

<b>CROSS SECTIONS</b> <b>WARWICK ROAD</b>	SHEET NO. 214
	TOTAL SHTS. 539

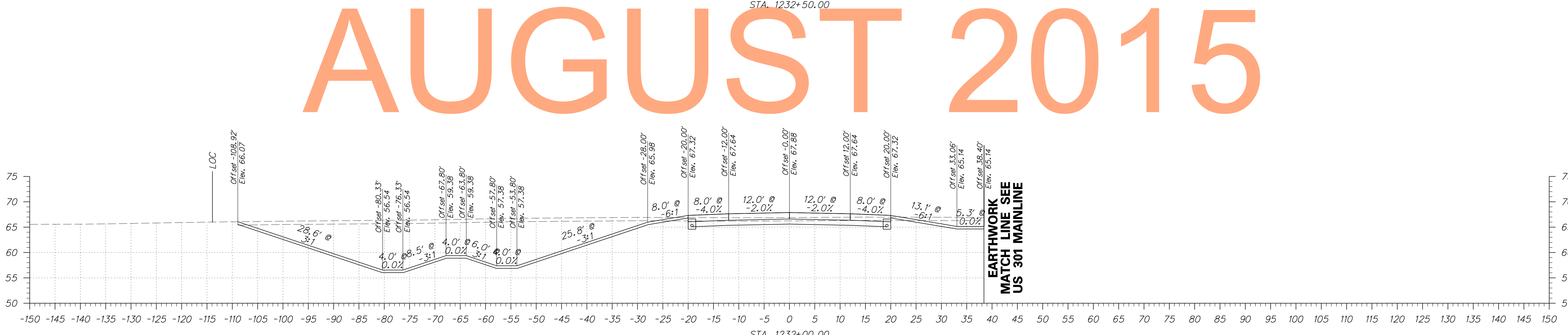
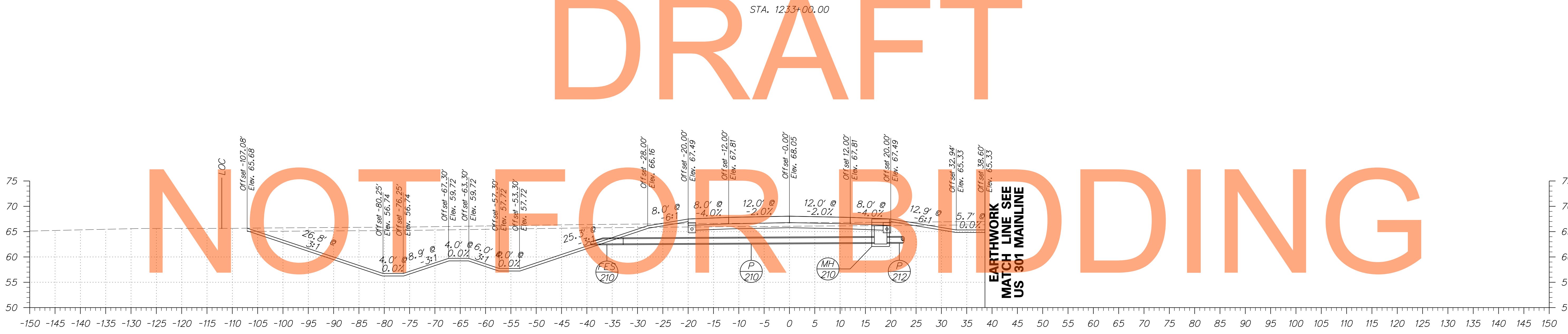
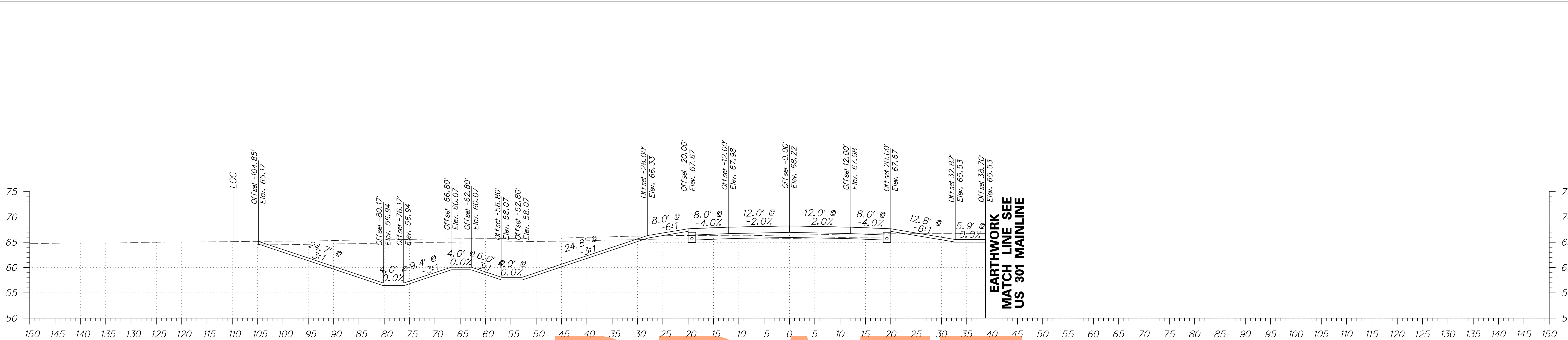

ADDENDUMS / REVISIONS	

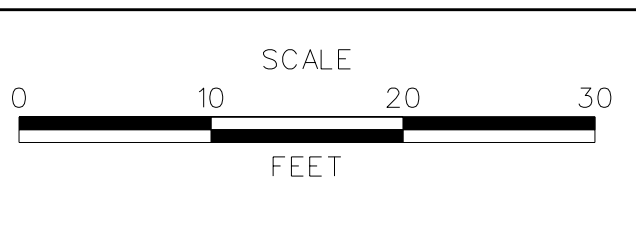

**US 301**  
**MARYLAND STATE LINE**  
**TO LEVELS ROAD**

CONTRACT T200811301	BRIDGE NO. 
COUNTY NEW CASTLE	DESIGNED BY: PB CHECKED BY: RK

**CROSS SECTIONS**  
**WARWICK ROAD**

SHEET NO. 215
TOTAL SHTS. 539

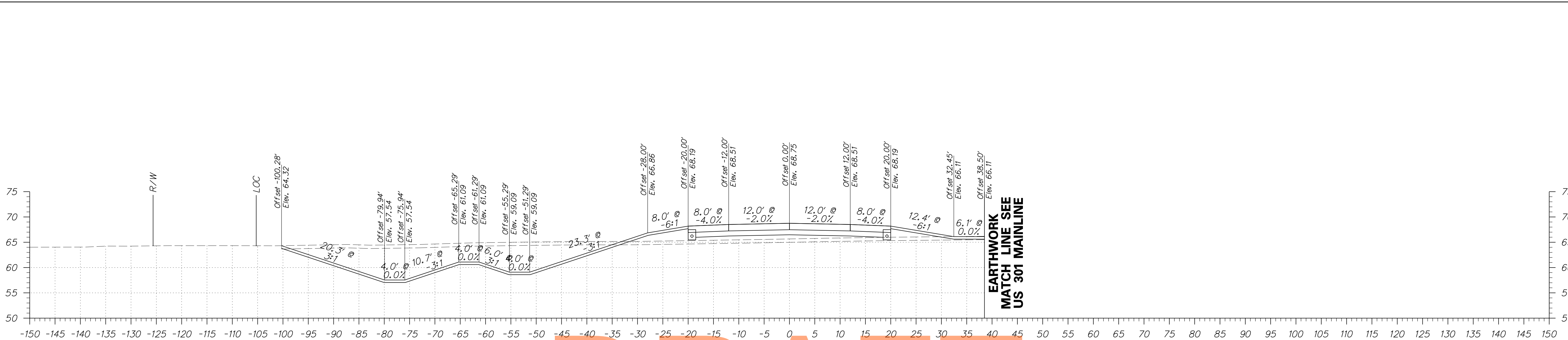

STA. 1234+50.00

EARTHWORK  
MATCH LINE SEE  
US 301 MAINLINE

DRAFT

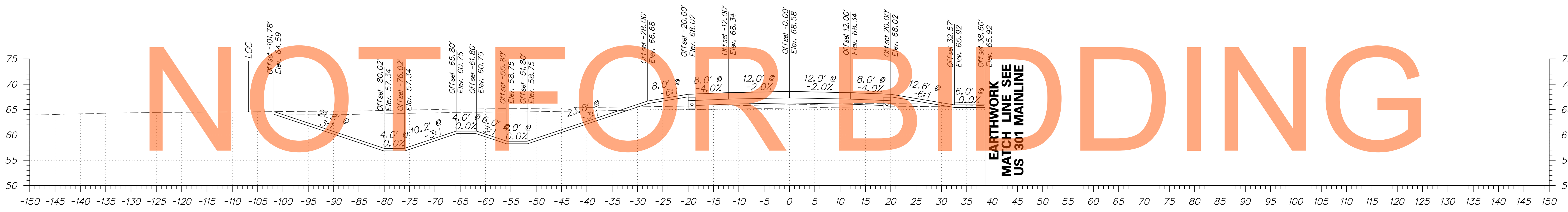

STA. 1234+00.00

EARTHWORK  
MATCH LINE SEE  
US 301 MAINLINE

AUGUST 2015

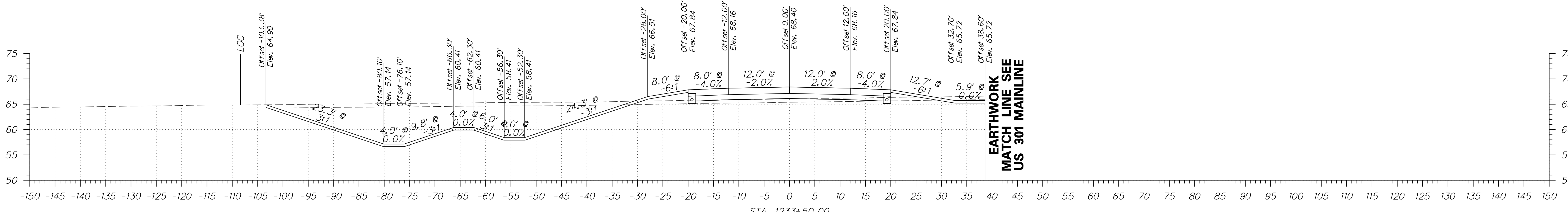

STA. 1233+50.00

EARTHWORK  
MATCH LINE SEE  
US 301 MAINLINE



ADDENDUMS / REVISIONS	

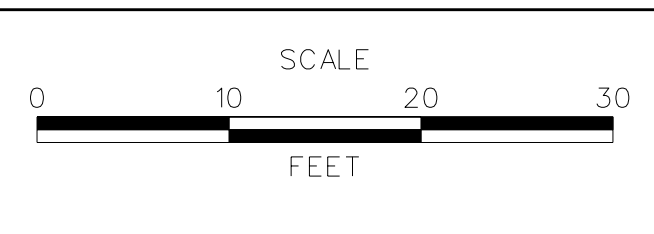

US 301  
MARYLAND STATE LINE  
TO LEVELS ROAD

CONTRACT T200811301	BRIDGE NO.
COUNTY NEW CASTLE	DESIGNED BY: PB CHECKED BY: RK

CROSS SECTIONS WARWICK ROAD	SHEET NO. 216
	TOTAL SHTS. 539



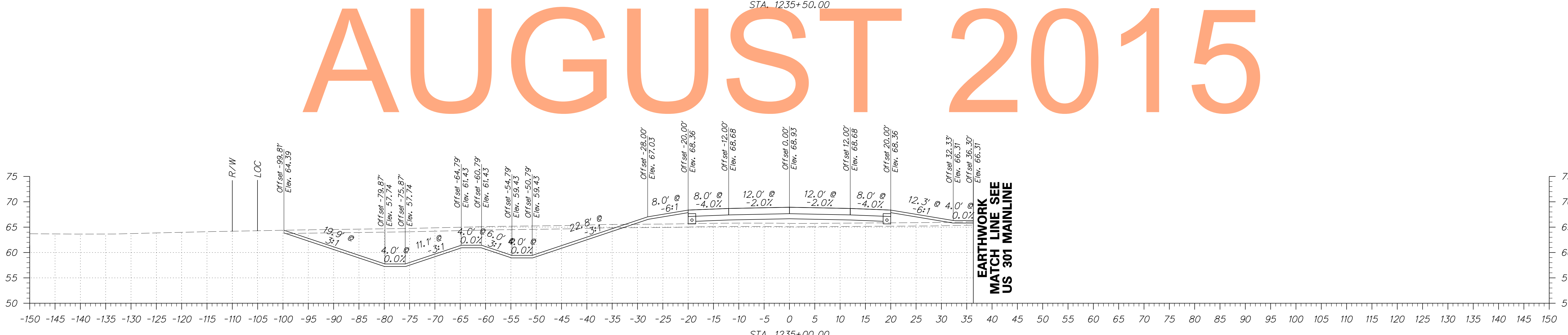
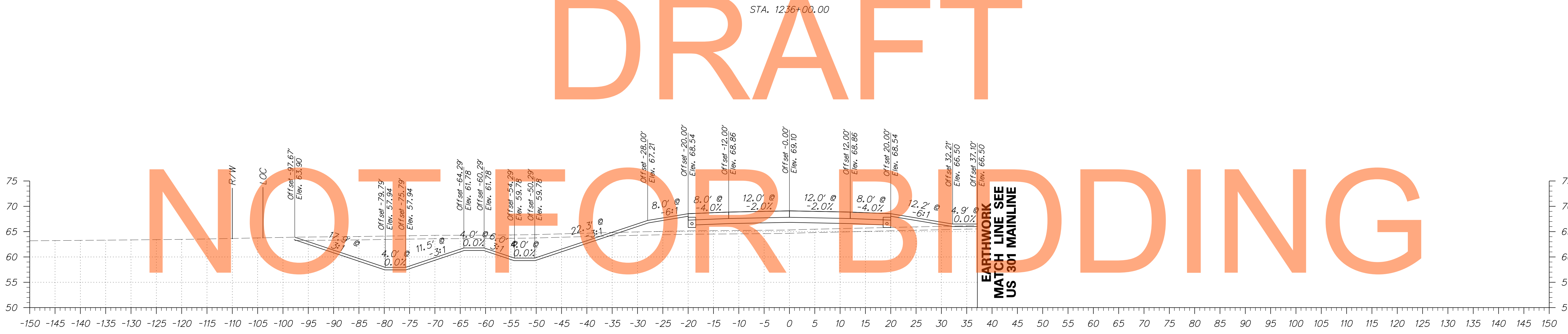
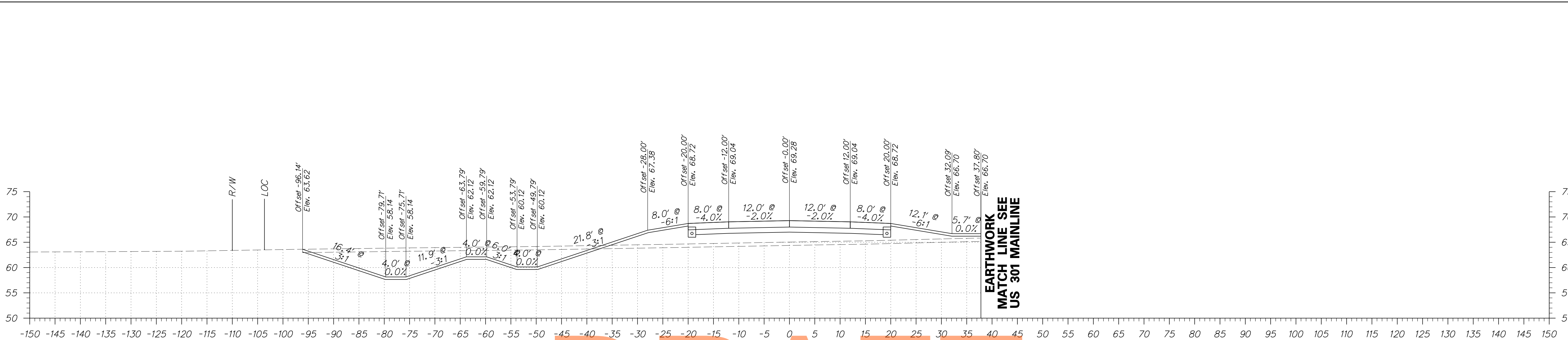

DRAFT

NOT FOR BIDDING

AUGUST 2015

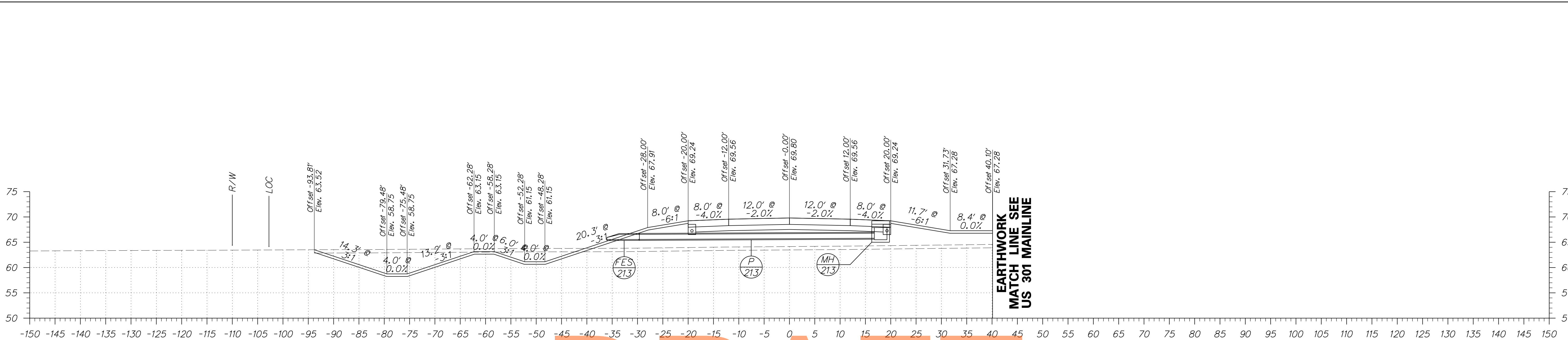

STA. 1237+50.00

DRAFT

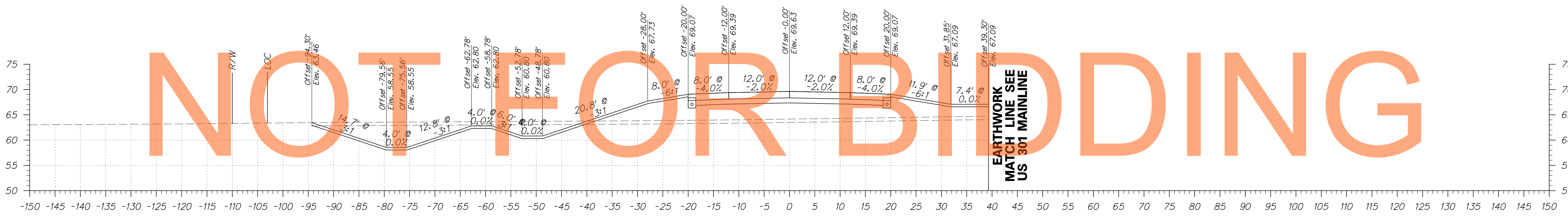

STA. 1237+00.00

AUGUST 2015

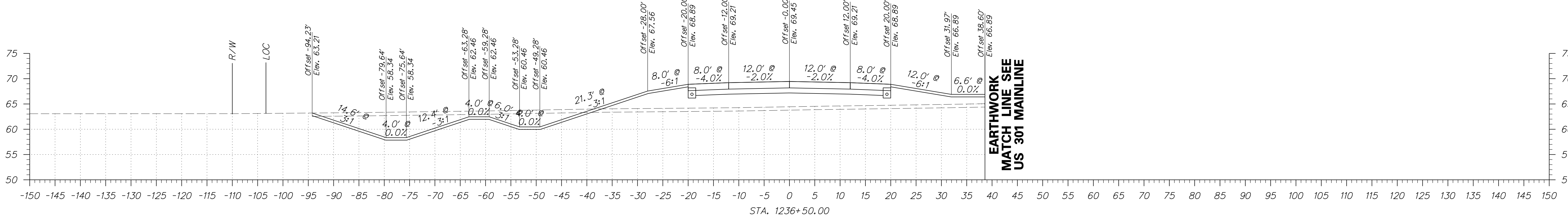

STA. 1236+50.00



ADDENDUMS / REVISIONS	

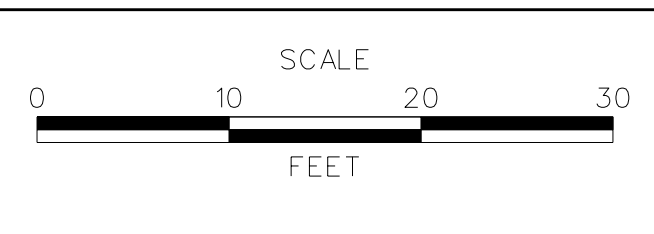

US 301  
MARYLAND STATE LINE  
TO LEVELS ROAD

CONTRACT T200811301	BRIDGE NO.
COUNTY NEW CASTLE	DESIGNED BY: PB
	CHECKED BY: RK

CROSS SECTIONS WARWICK ROAD	SHEET NO. 218
	TOTAL SHTS. 539

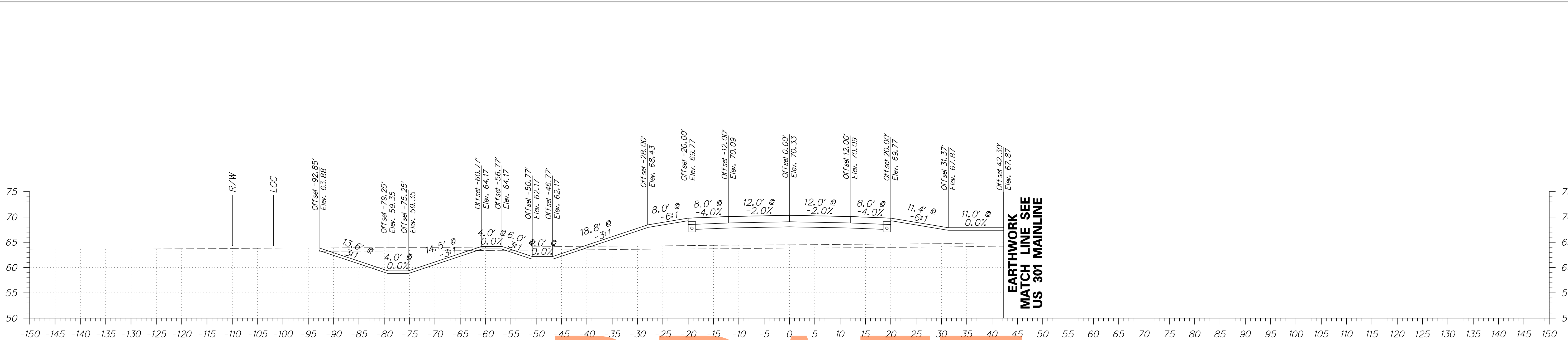

DRAFT

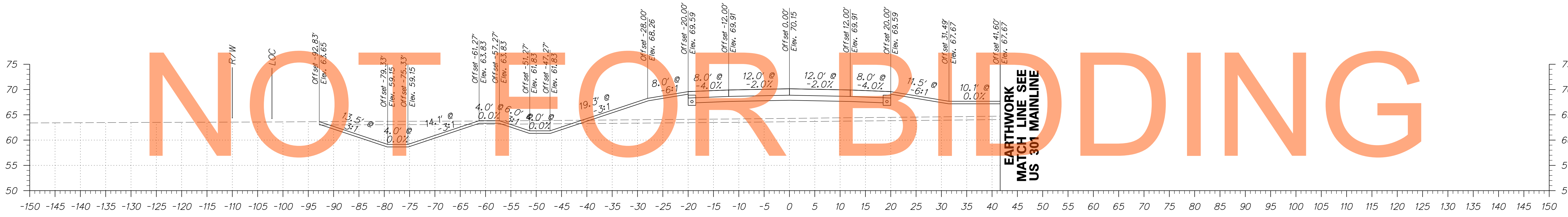

AUGUST 2015

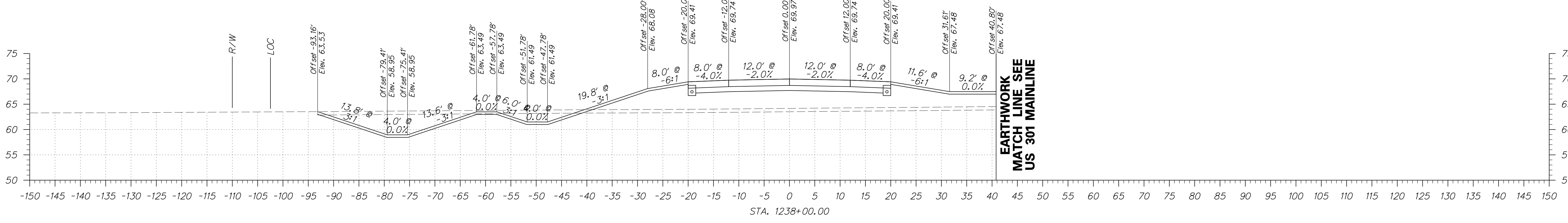

ADDENDUMS / REVISIONS

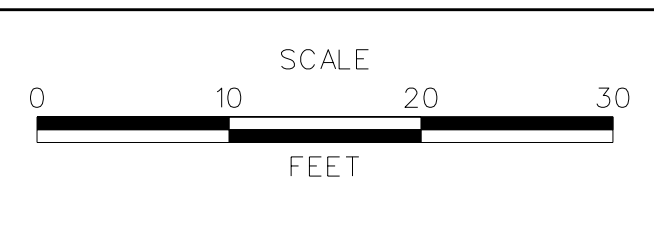

US 301  
MARYLAND STATE LINE  
TO LEVELS ROAD

CONTRACT T200811301	BRIDGE NO.
COUNTY NEW CASTLE	DESIGNED BY: PB
	CHECKED BY: RK

CROSS SECTIONS WARWICK ROAD	SHEET NO. 219
	TOTAL SHTS. 539

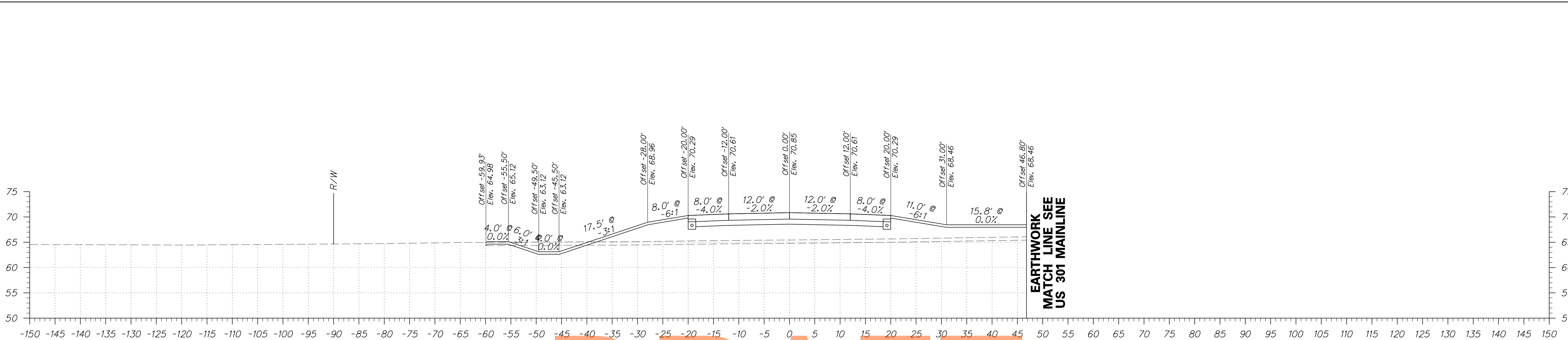

STA. 1240+50.00

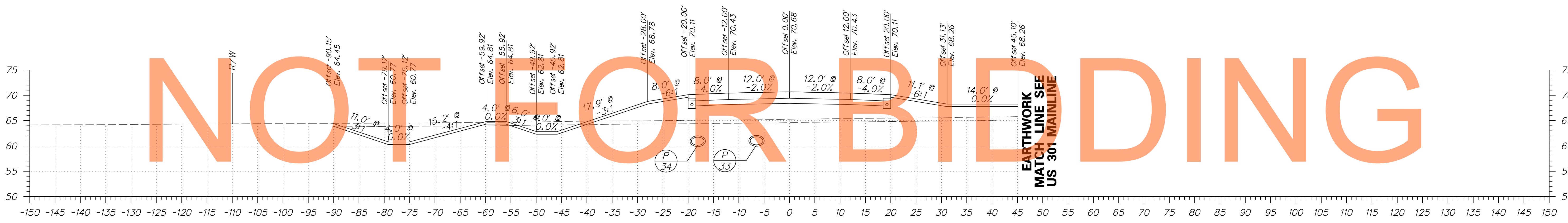

STA. 1240+00.00

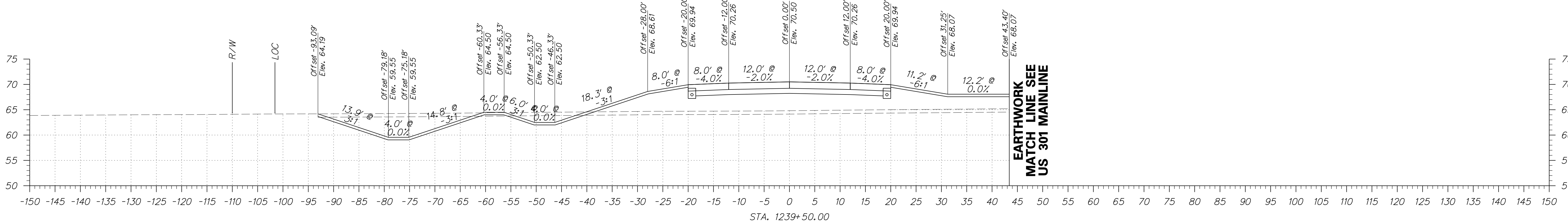

STA. 1239+50.00

DRAFT

NOT FOR BIDDING

AUGUST 2015



ADDENDUMS / REVISIONS	

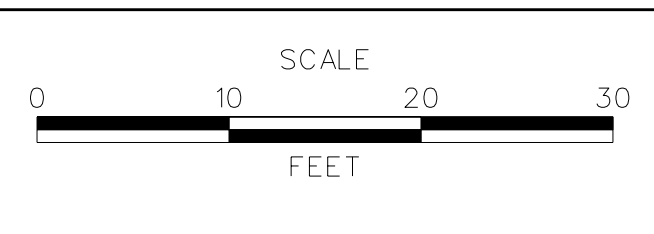

**US 301  
MARYLAND STATE LINE  
TO LEVELS ROAD**

CONTRACT T200811301	BRIDGE NO.
COUNTY NEW CASTLE	DESIGNED BY: PB
	CHECKED BY: RK

<b>CROSS SECTIONS WARWICK ROAD</b>	SHEET NO. 220
	TOTAL SHTS. 539

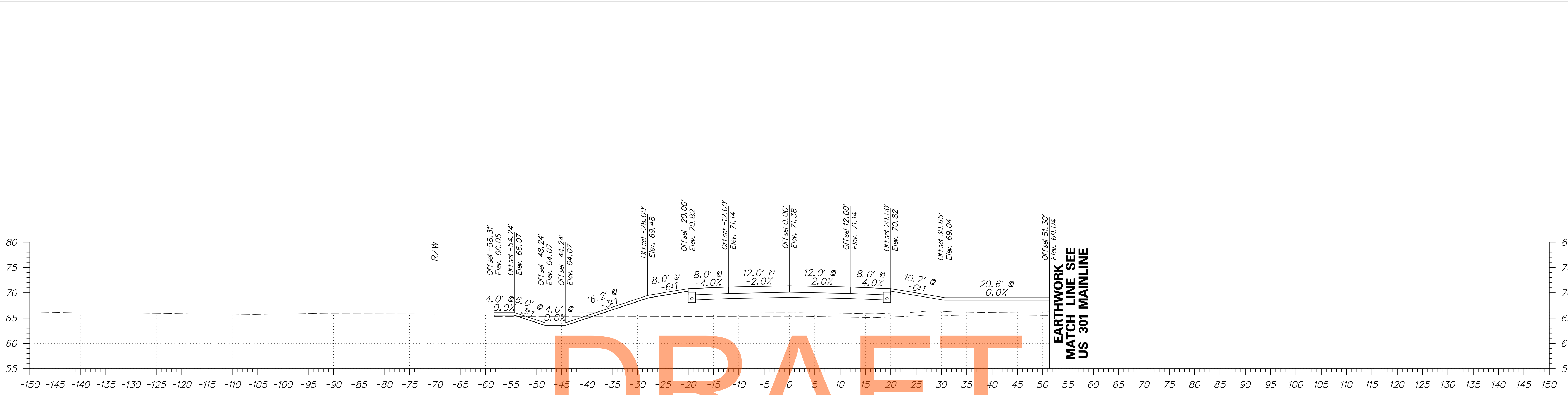

**DRAFT**

**NOT FOR BIDDING**

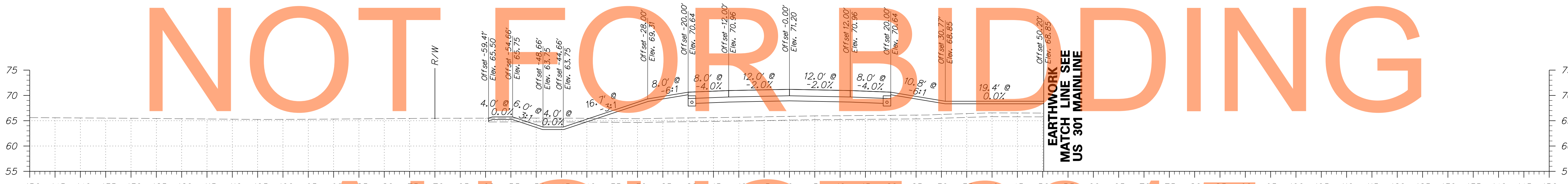

**AUGUST 2015**

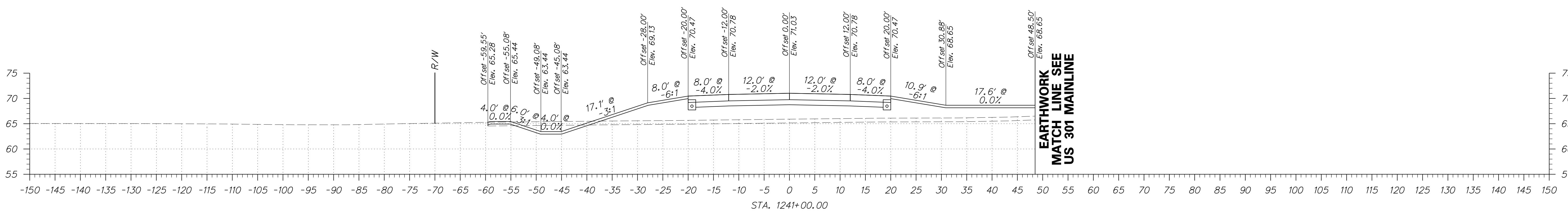

ADDENDUMS / REVISIONS	

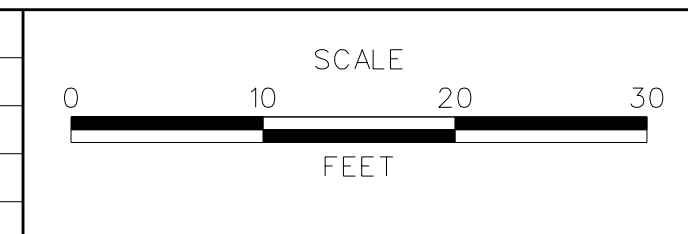

**US 301  
MARYLAND STATE LINE  
TO LEVELS ROAD**

CONTRACT T200811301	BRIDGE NO.
COUNTY NEW CASTLE	DESIGNED BY: PB CHECKED BY: RK

**CROSS SECTIONS  
WARWICK ROAD**

SHEET NO. 221
TOTAL SHTS. 539

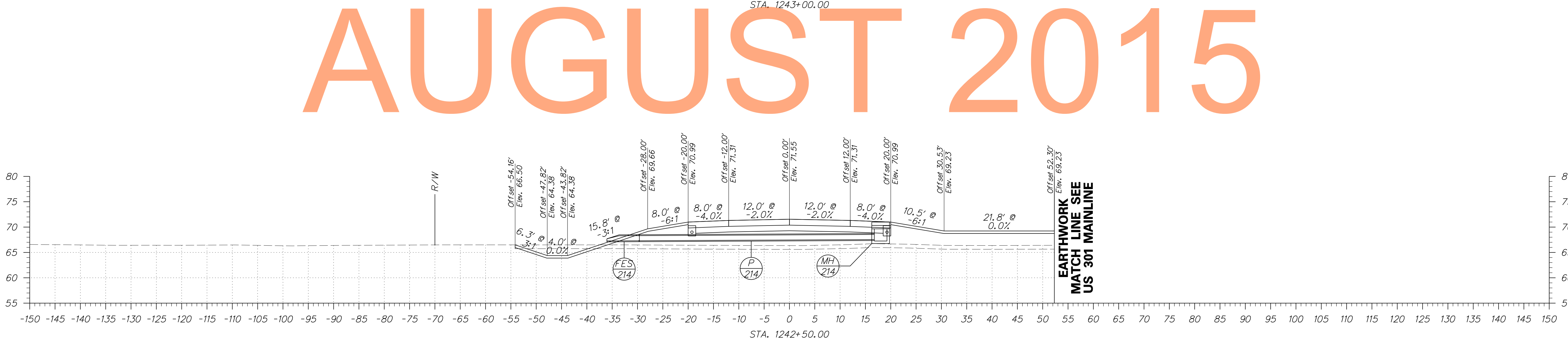
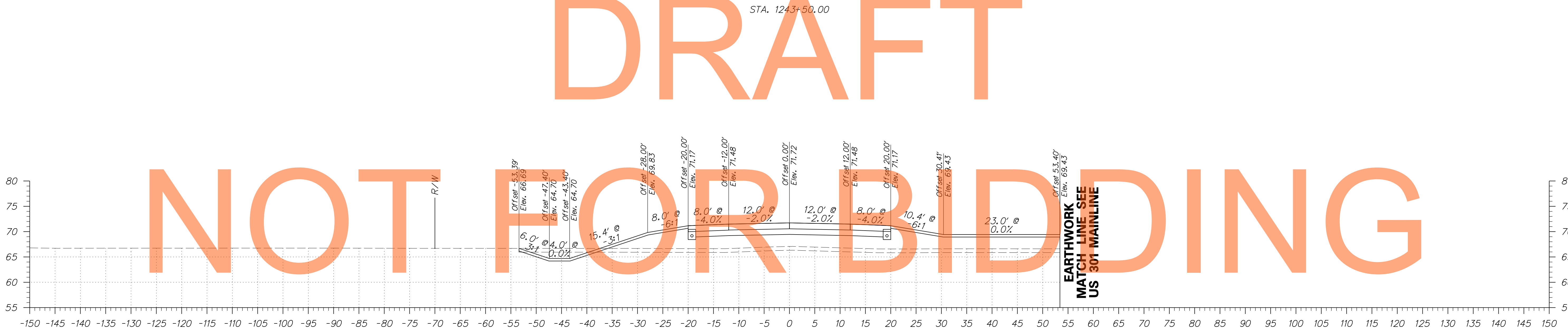
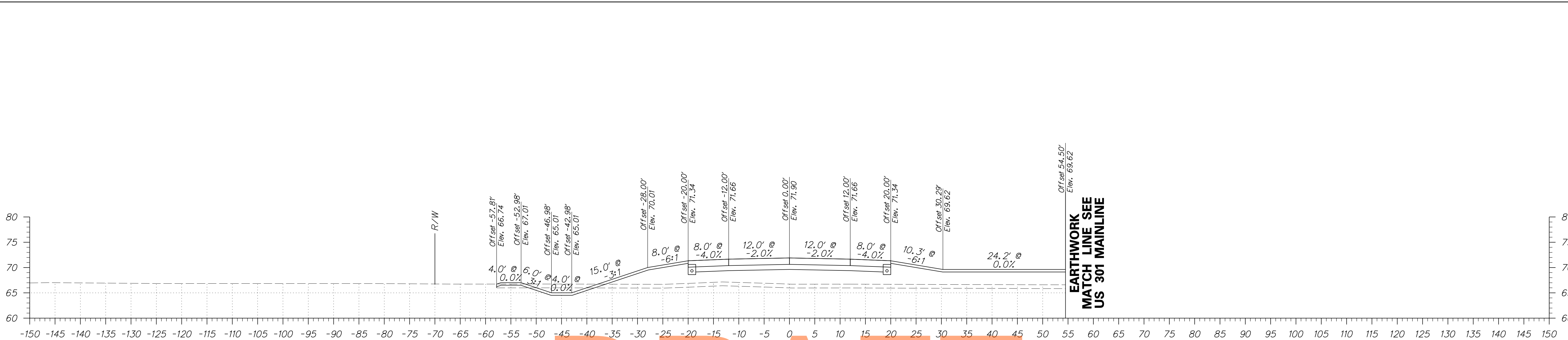

DRAFT

NOT FOR BIDDING

AUGUST 2015

# DRAFT

# NOT FOR BIDDING

# AUGUST 2015

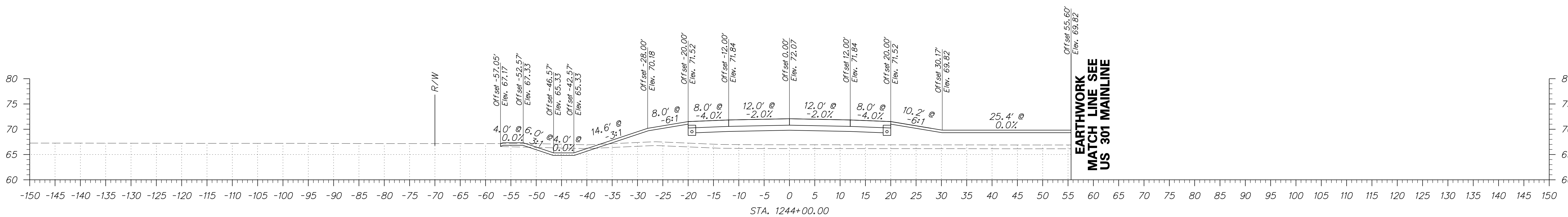
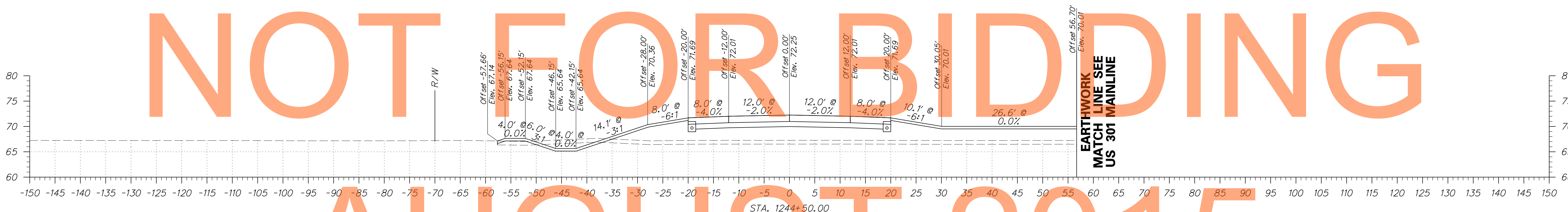
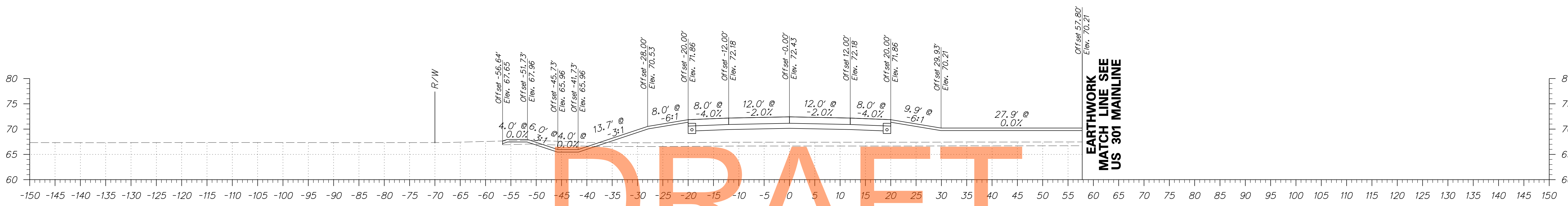

DRAFT

NOT FOR BIDDING

AUGUST 2015

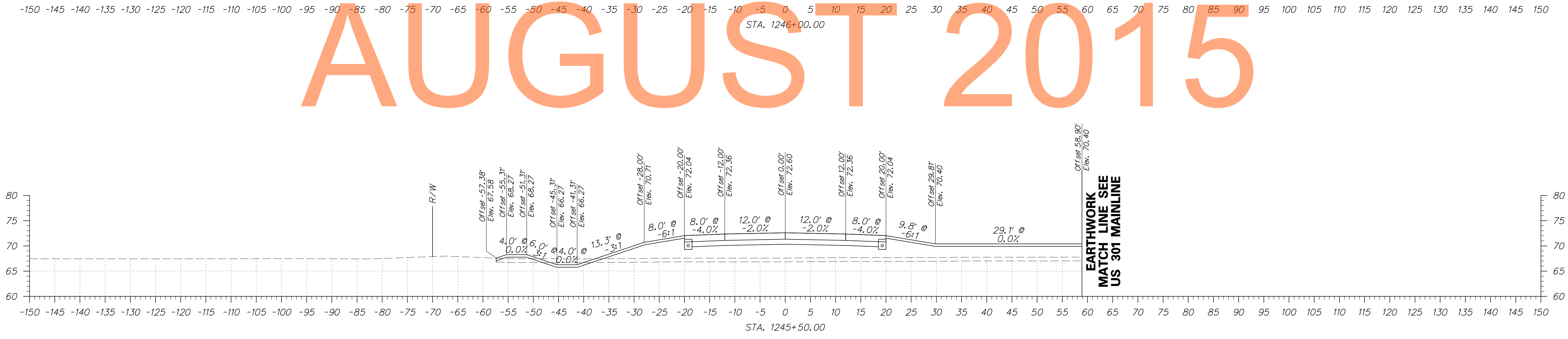
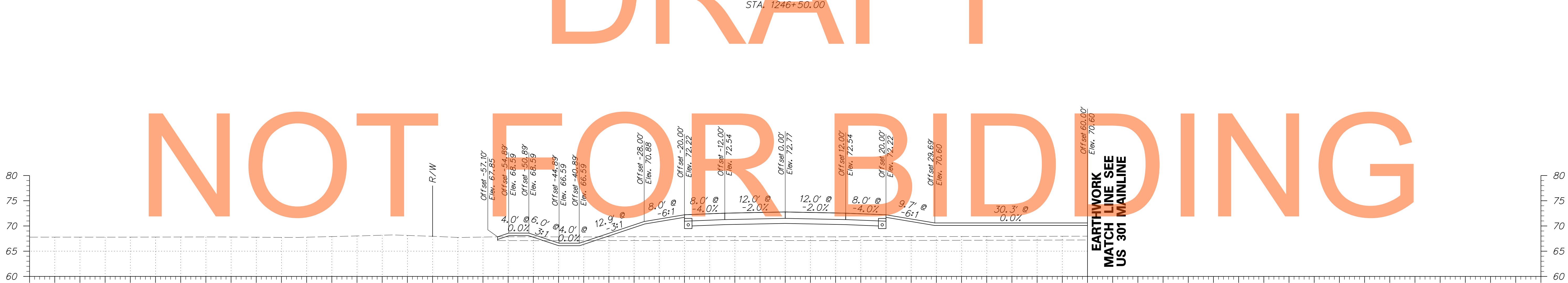
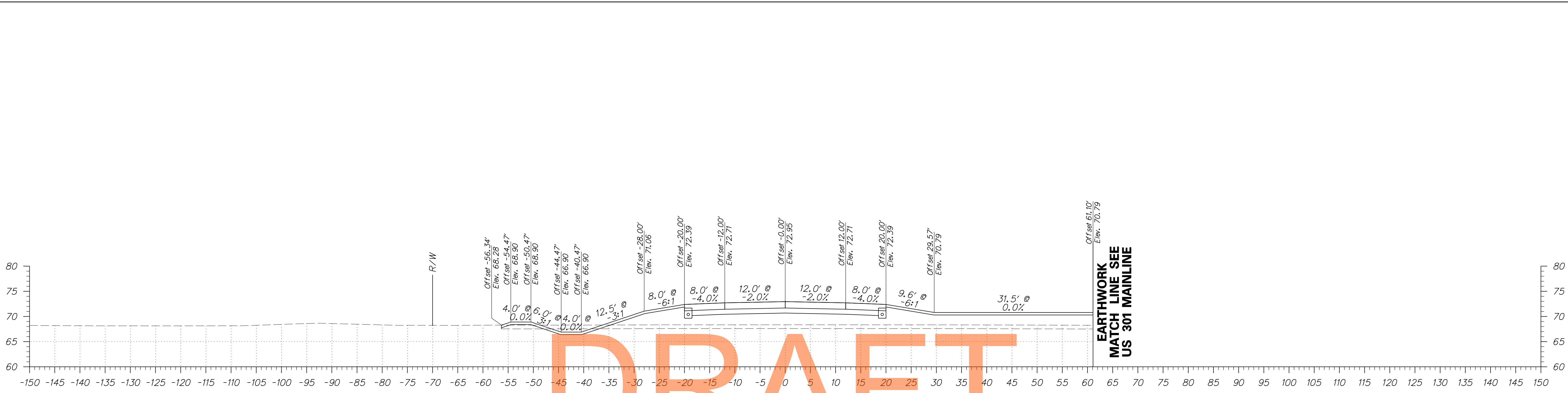



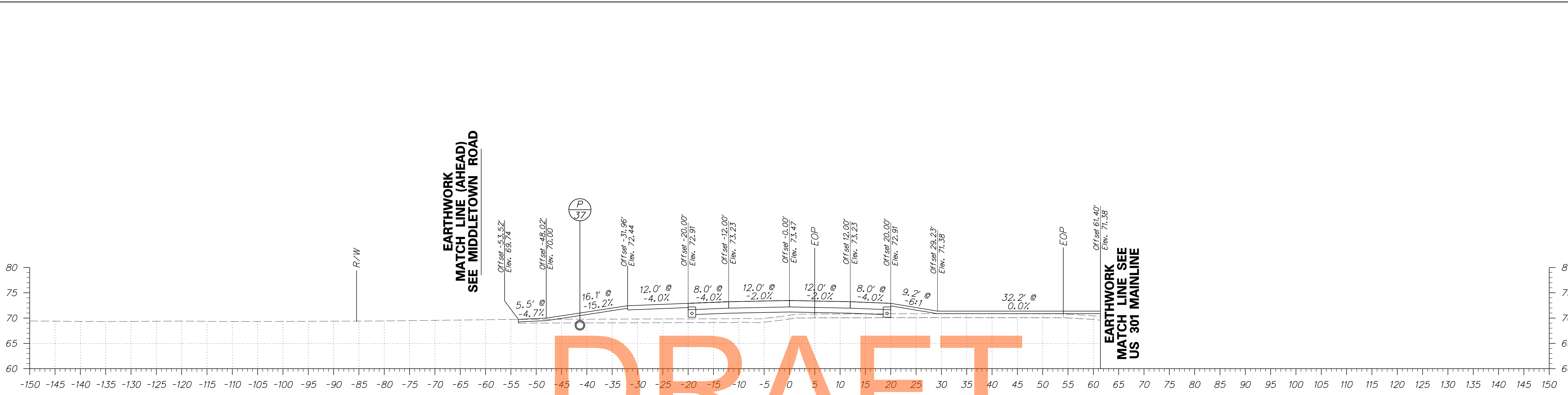

DRAFT

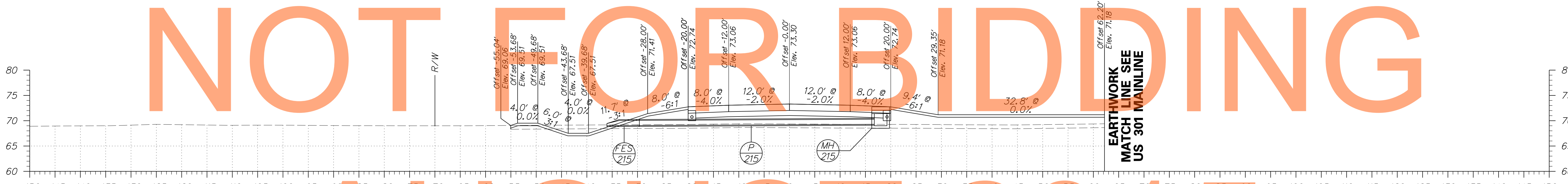

AUGUST 2015

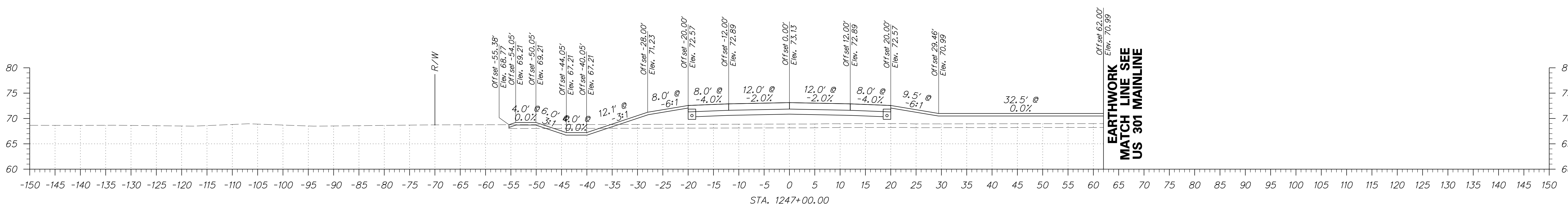

# DRAFT

# NOT FOR BIDDING

# AUGUST 2015

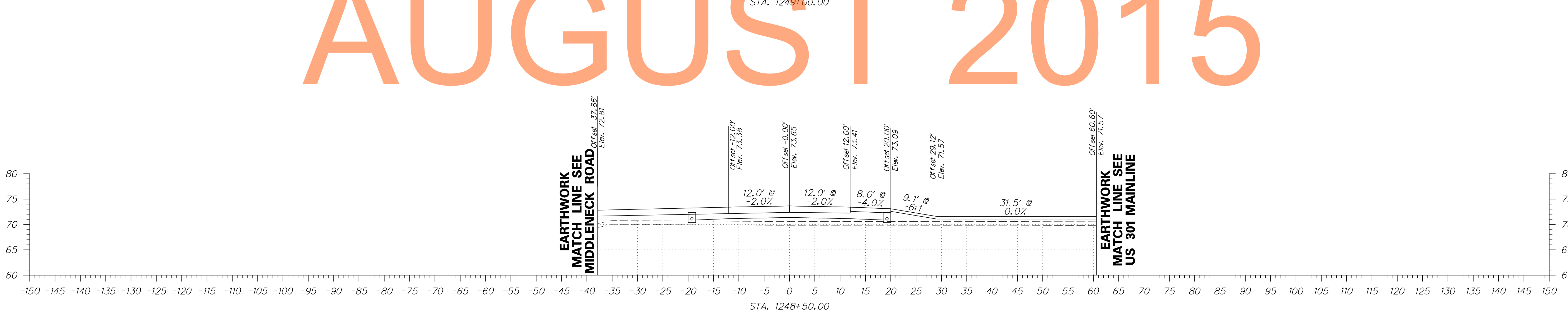
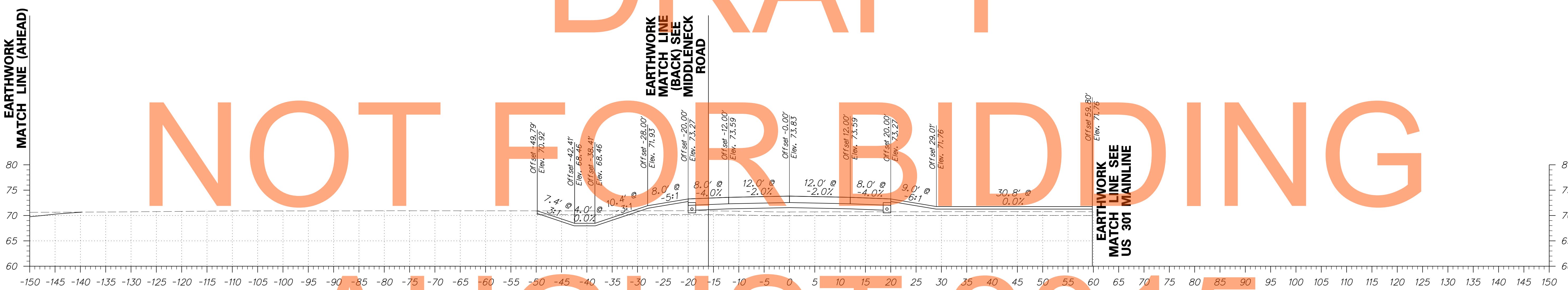
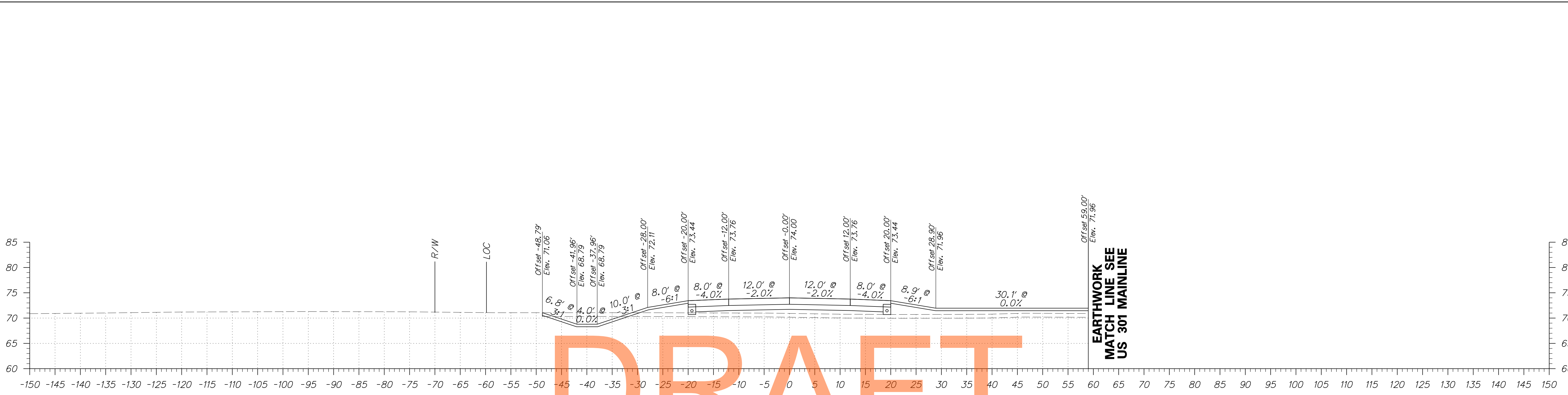

ADDENDUMS / REVISIONS	

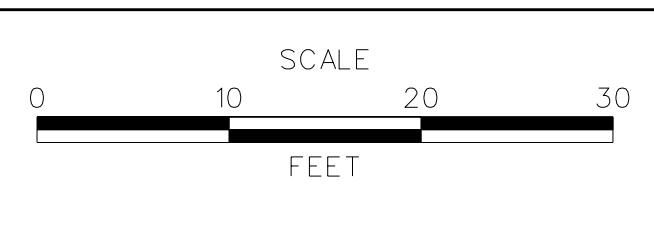

**US 301  
MARYLAND STATE LINE  
TO LEVELS ROAD**

CONTRACT T200811301	BRIDGE NO.
COUNTY NEW CASTLE	DESIGNED BY: PB CHECKED BY: RK

<b>CROSS SECTIONS WARWICK ROAD</b>	SHEET NO. 226
	TOTAL SHTS. 539

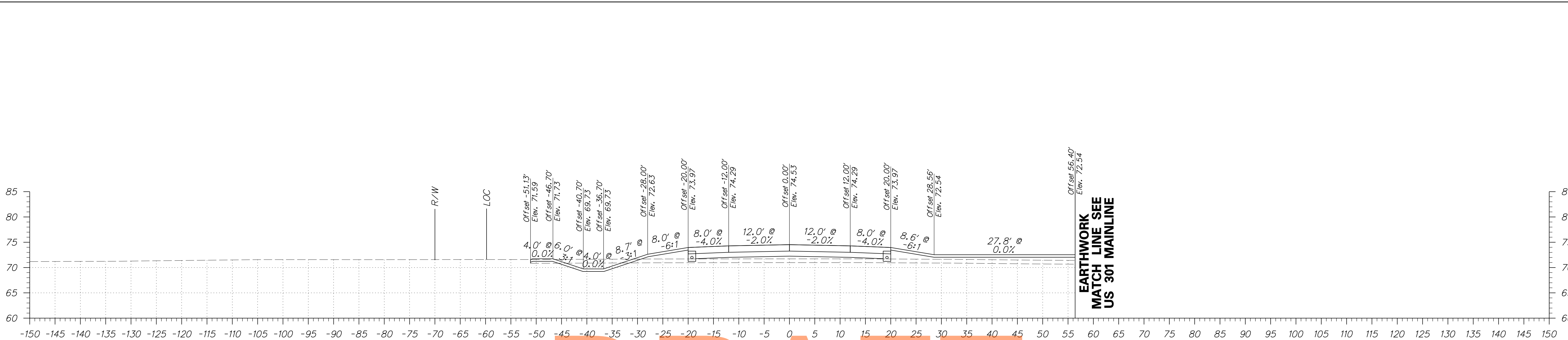

DRAFT

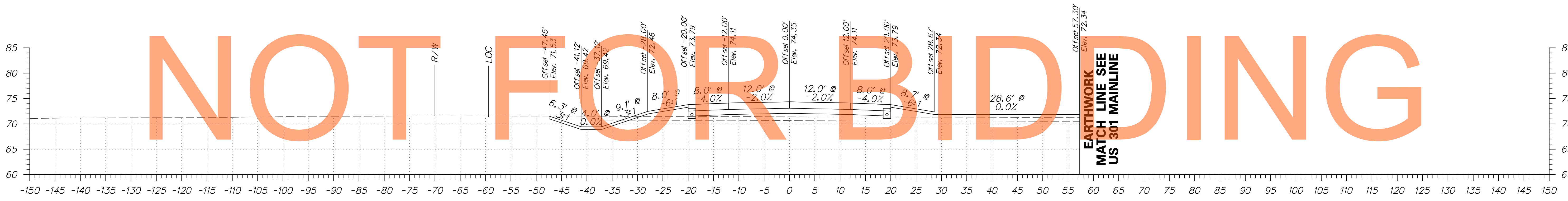

AUGUST 2015

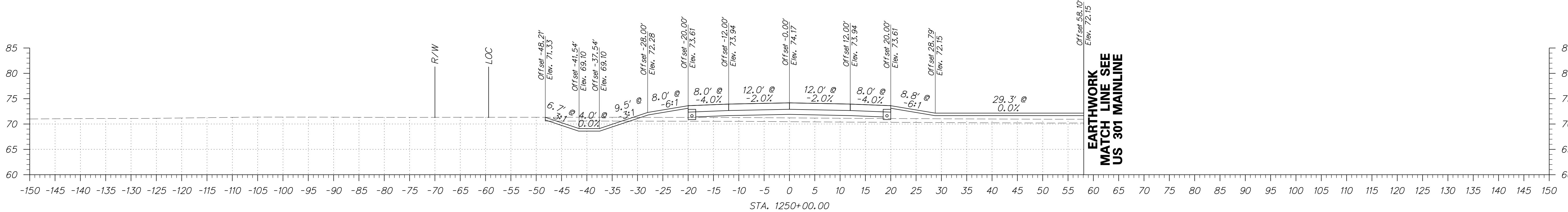

ADDENDUMS / REVISIONS	

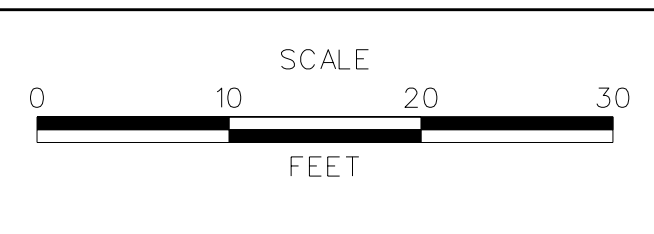

US 301  
MARYLAND STATE LINE  
TO LEVELS ROAD

CONTRACT T200811301	BRIDGE NO.
COUNTY NEW CASTLE	DESIGNED BY: PB CHECKED BY: RK

CROSS SECTIONS WARWICK ROAD	SHEET NO. 227
	TOTAL SHTS. 539

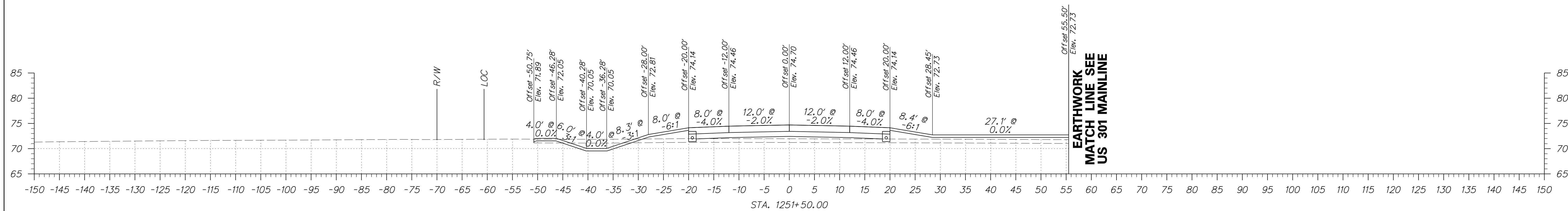
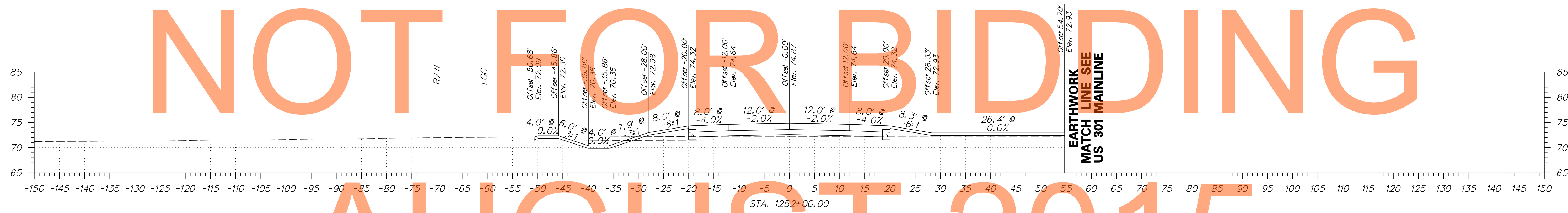
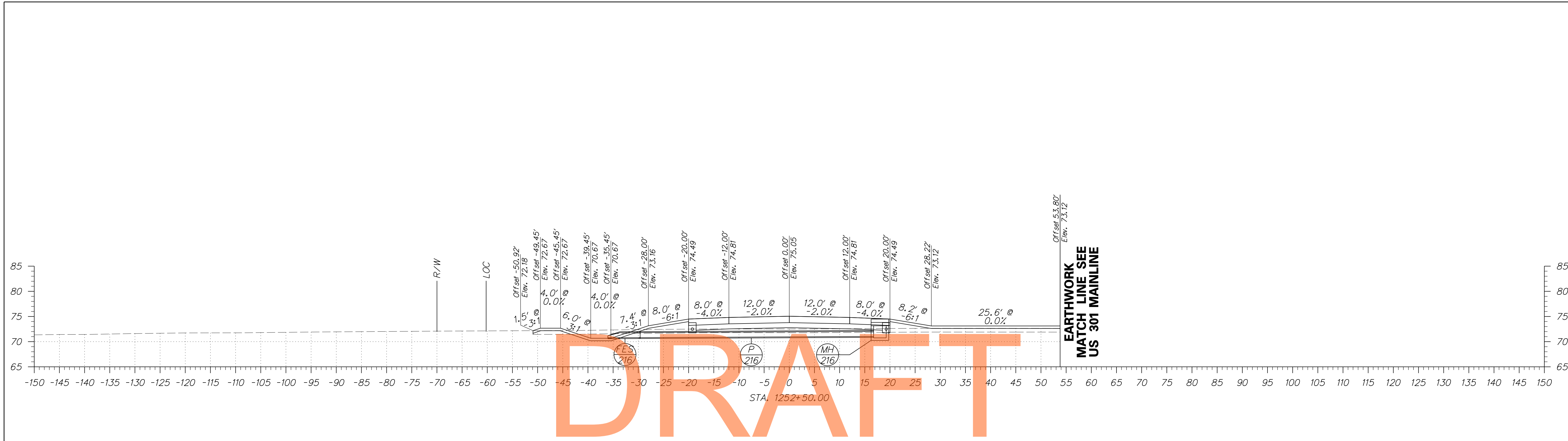

DRAFT

NOT FOR BIDDING

AUGUST 2015

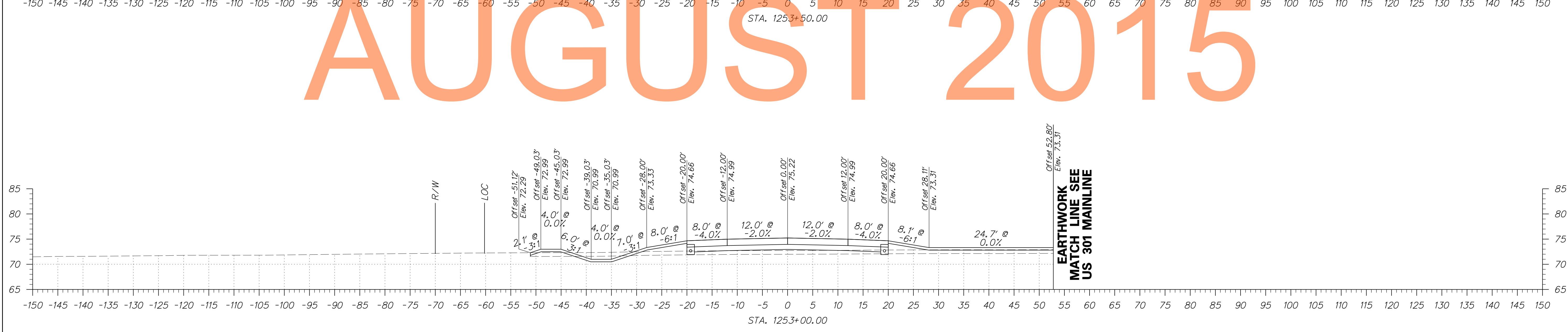
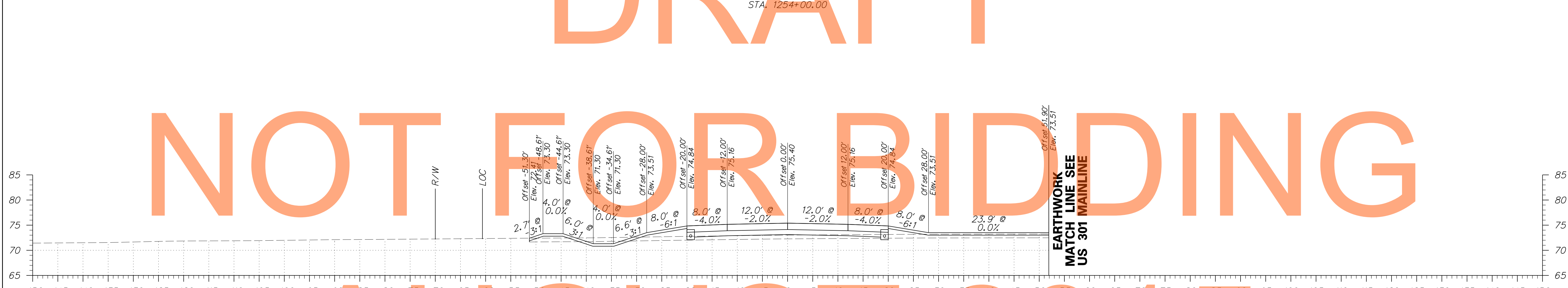
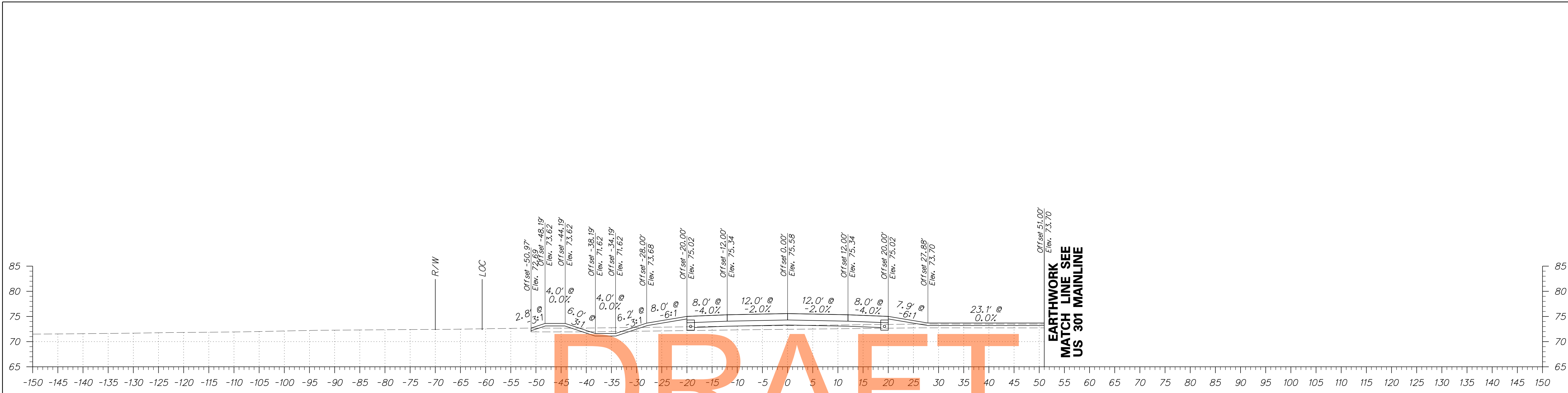

ADDENDUMS / REVISIONS	

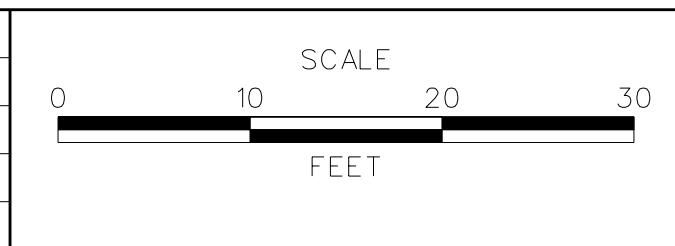

**US 301  
MARYLAND STATE LINE  
TO LEVELS ROAD**

CONTRACT T200811301	BRIDGE NO.
COUNTY NEW CASTLE	DESIGNED BY: PB CHECKED BY: RK

<b>CROSS SECTIONS WARWICK ROAD</b>	SHEET NO. 229
	TOTAL SHTS. 539

# DRAFT

# NOT FOR BIDDING

# AUGUST 2015

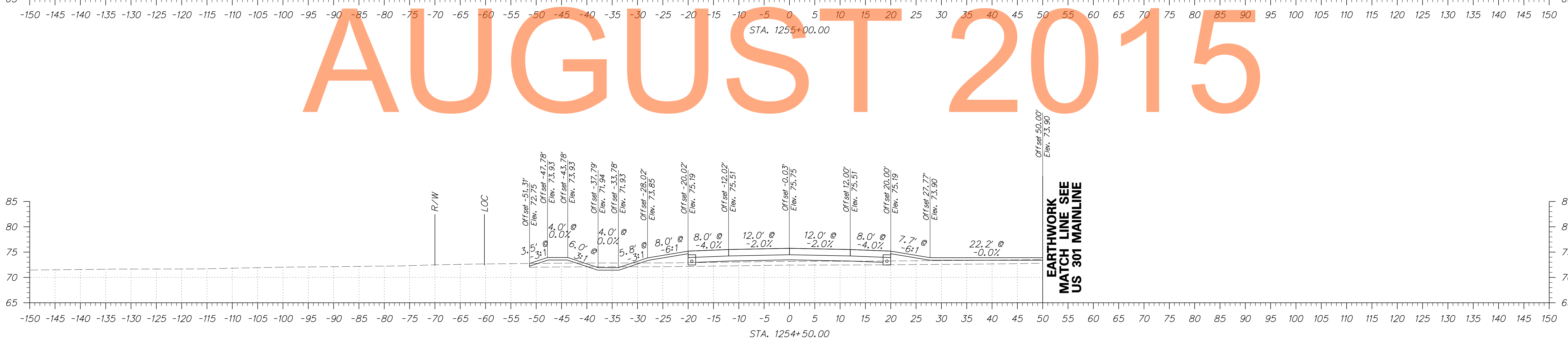
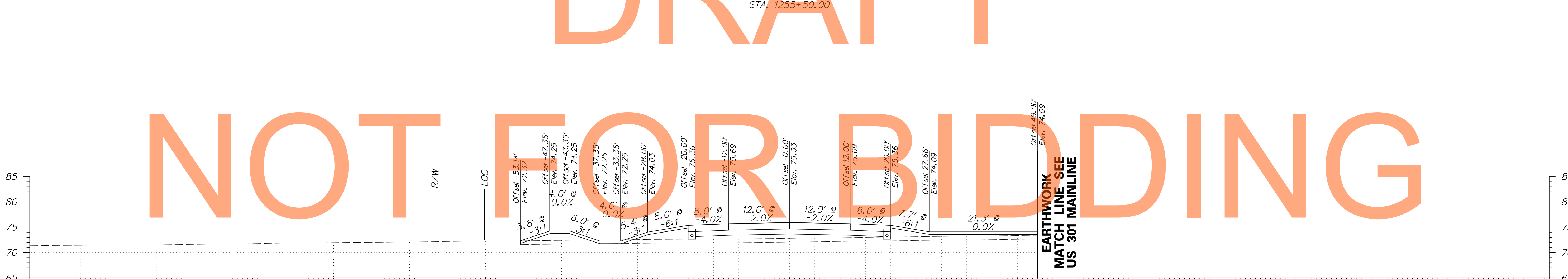
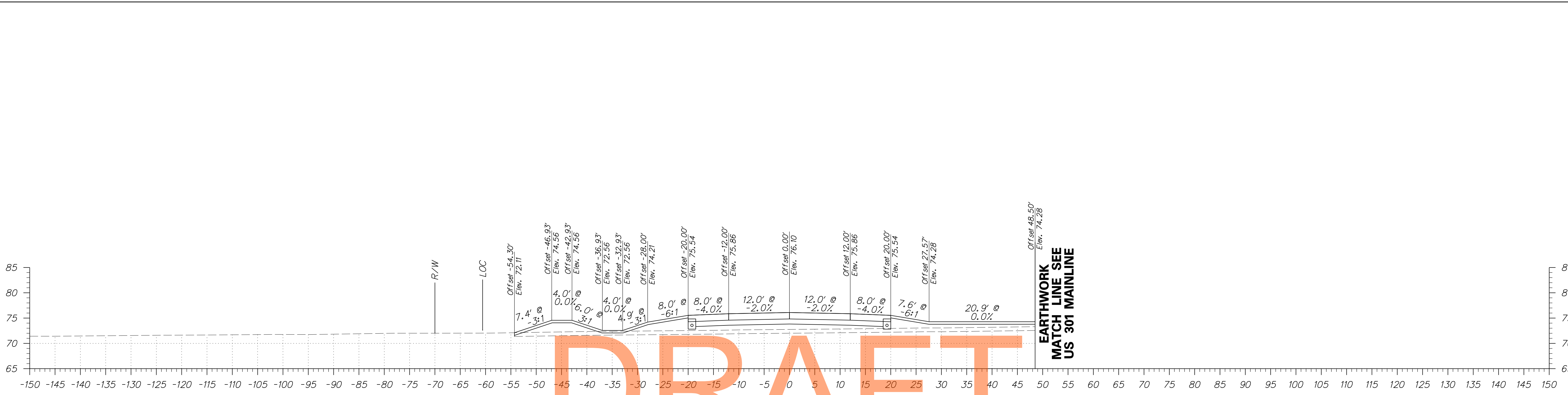

ADDENDUMS / REVISIONS

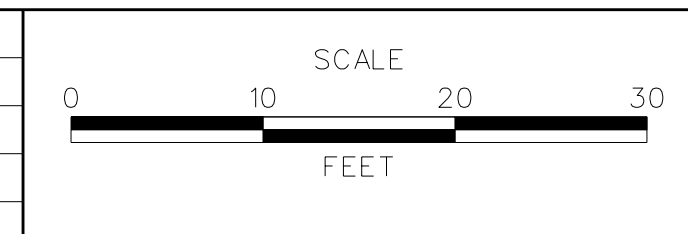

**US 301  
MARYLAND STATE LINE  
TO LEVELS ROAD**

CONTRACT T200811301	BRIDGE NO. 
COUNTY NEW CASTLE	DESIGNED BY: PB CHECKED BY: RK

**CROSS SECTIONS  
WARWICK ROAD**

SHEET NO. 230
TOTAL SHTS. 539

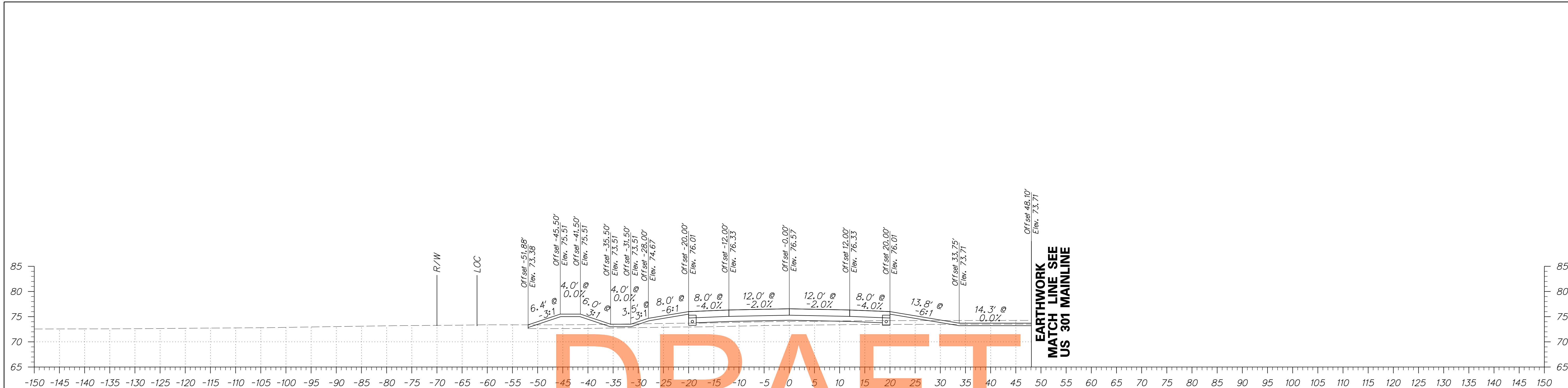

DRAFT

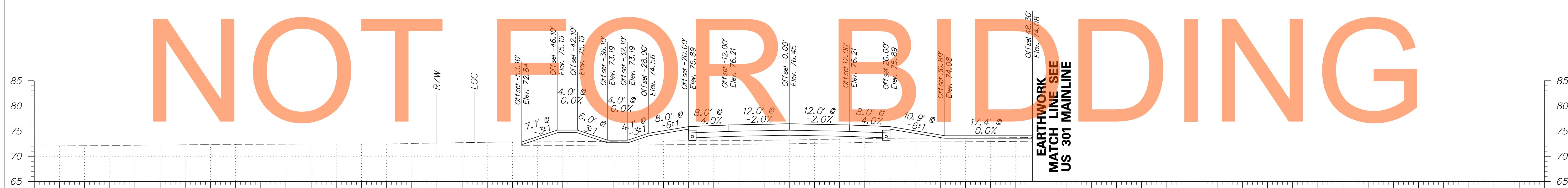

AUGUST 2015

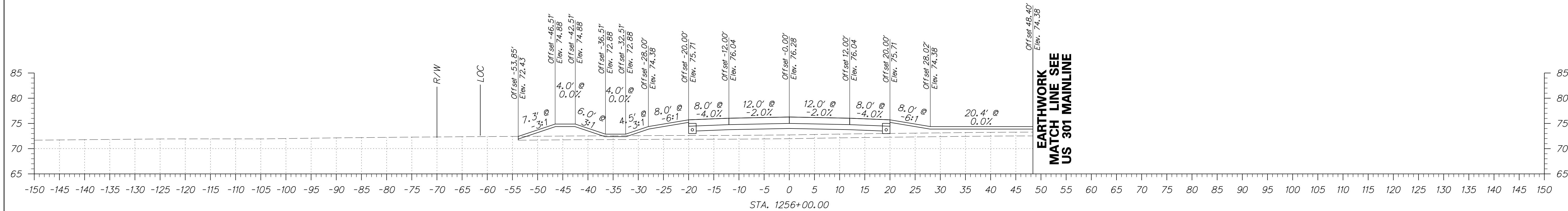

ADDENDUMS / REVISIONS	

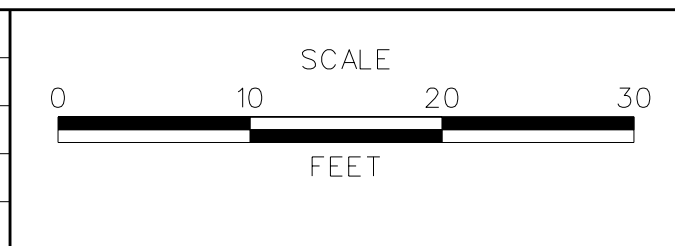

**US 301  
MARYLAND STATE LINE  
TO LEVELS ROAD**

CONTRACT T200811301	BRIDGE NO.
COUNTY NEW CASTLE	DESIGNED BY: PB
	CHECKED BY: RK

<b>CROSS SECTIONS WARWICK ROAD</b>
SHEET NO. 231
TOTAL SHTS. 539

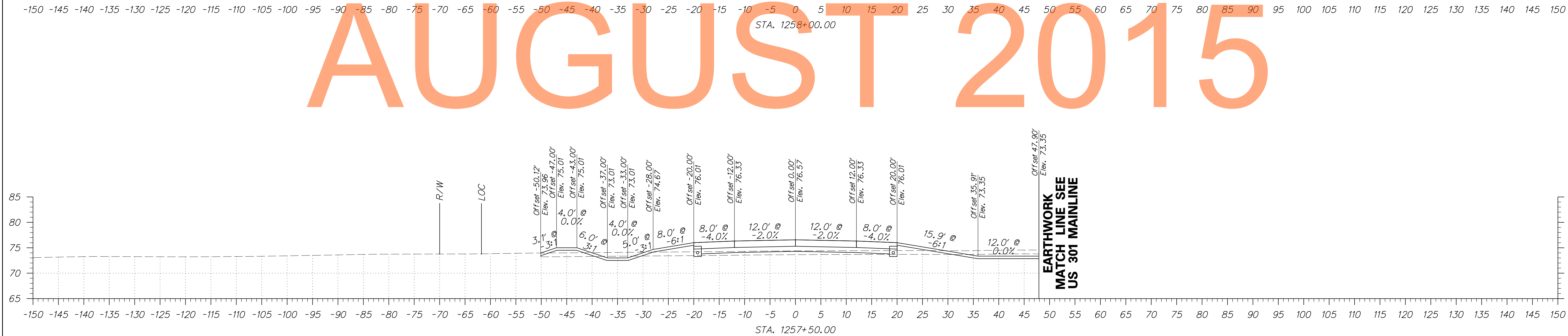
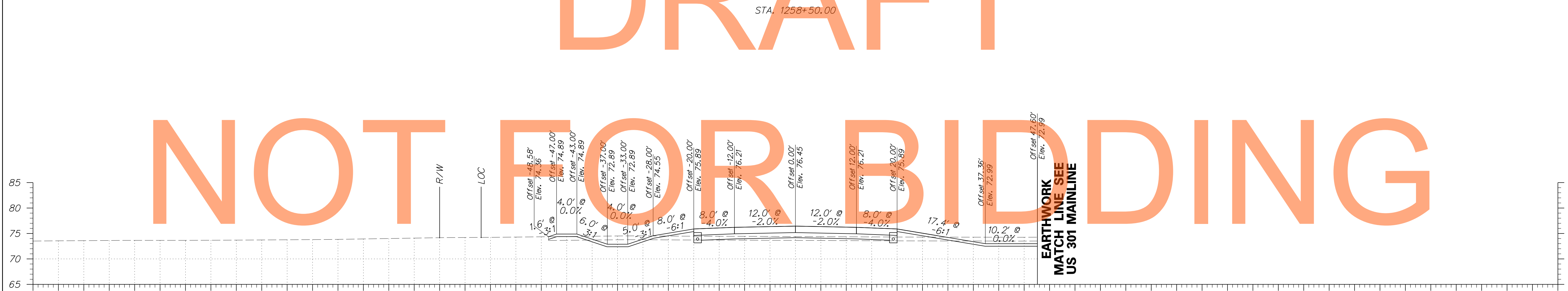
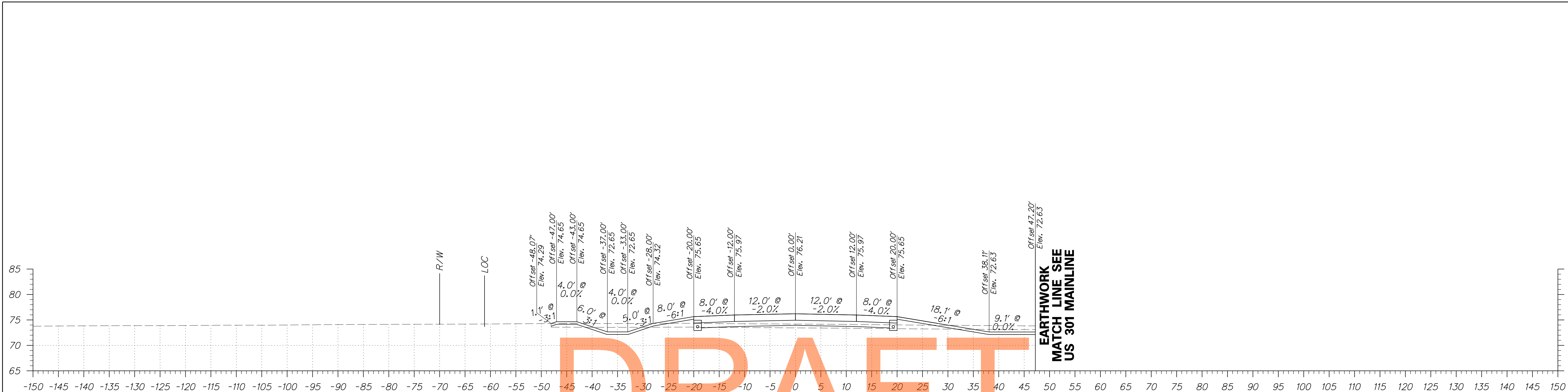



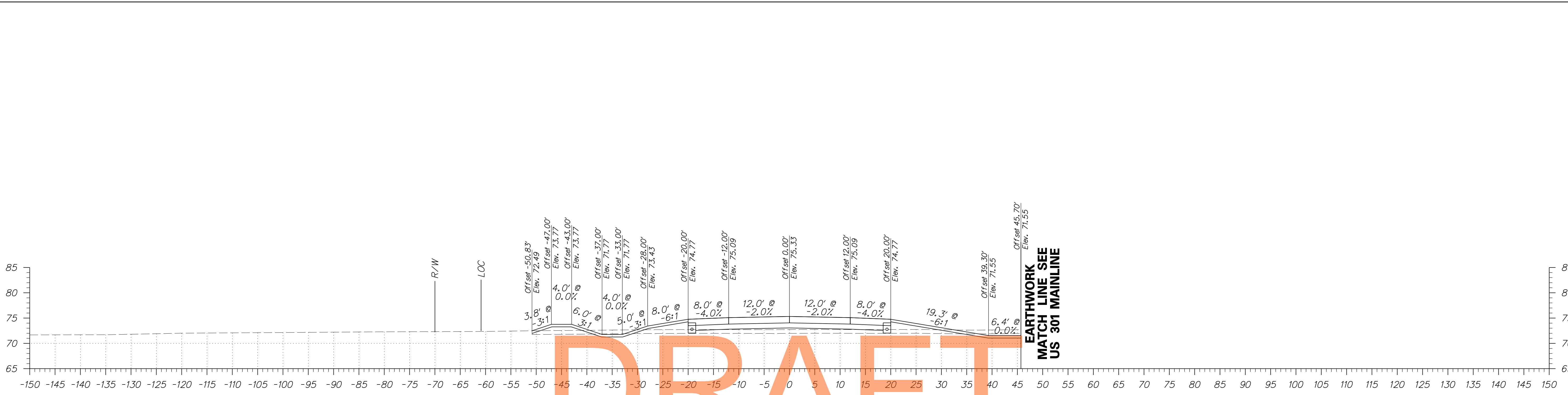

DRAFT

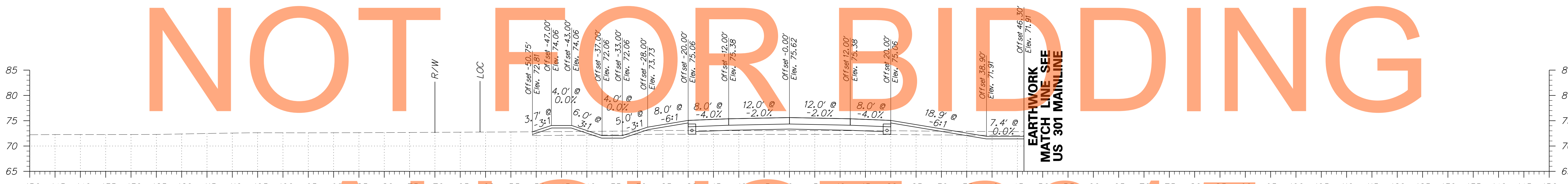

AUGUST 2015

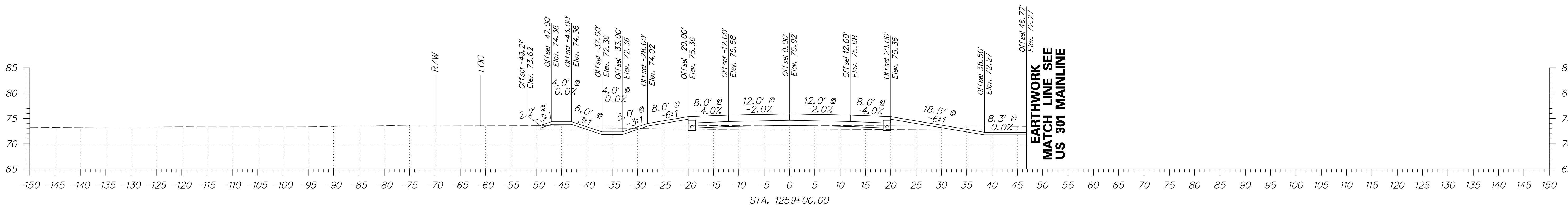

ADDENDUMS / REVISIONS	

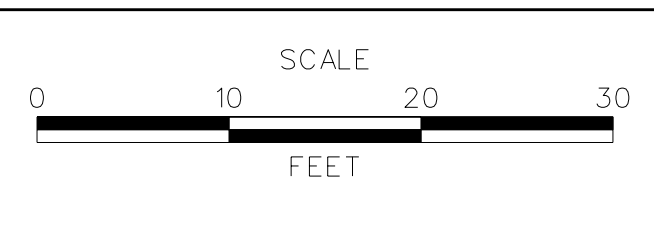

**US 301  
MARYLAND STATE LINE  
TO LEVELS ROAD**

CONTRACT T200811301	BRIDGE NO. 
COUNTY NEW CASTLE	DESIGNED BY: PB CHECKED BY: RK

<b>CROSS SECTIONS WARWICK ROAD</b>	SHEET NO. 233
	TOTAL SHTS. 539

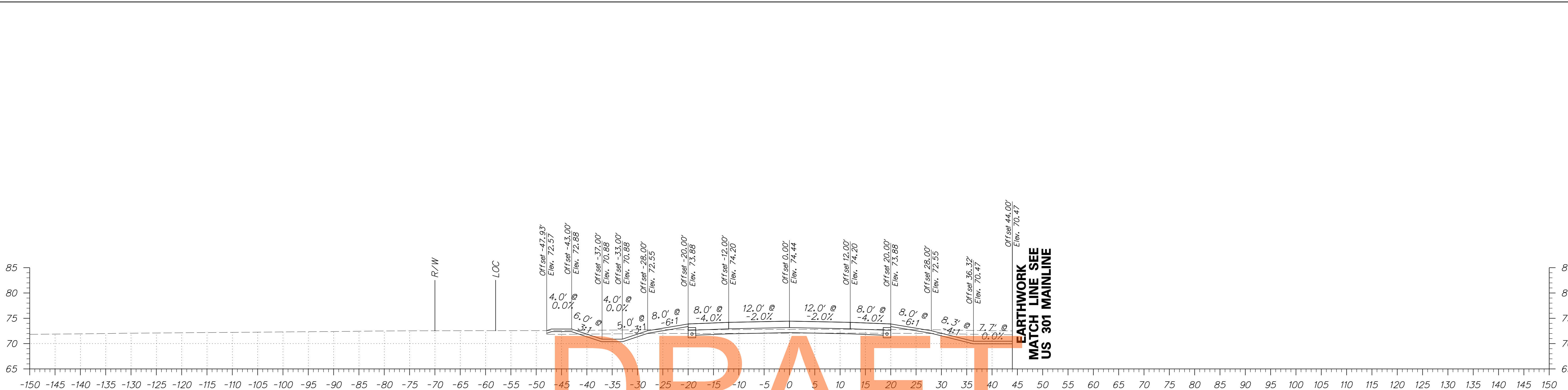

**DRAFT**

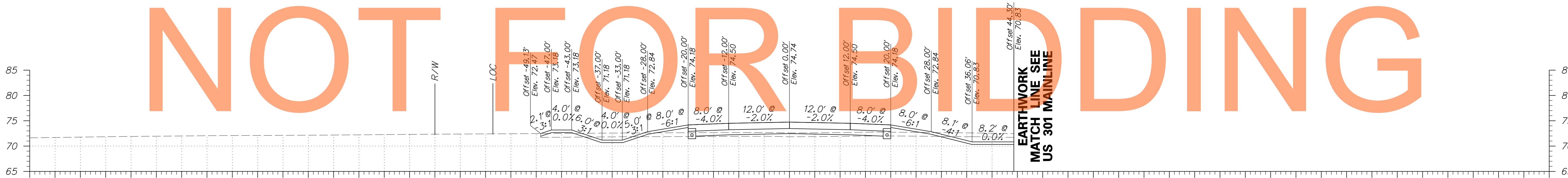

**AUGUST 2015**

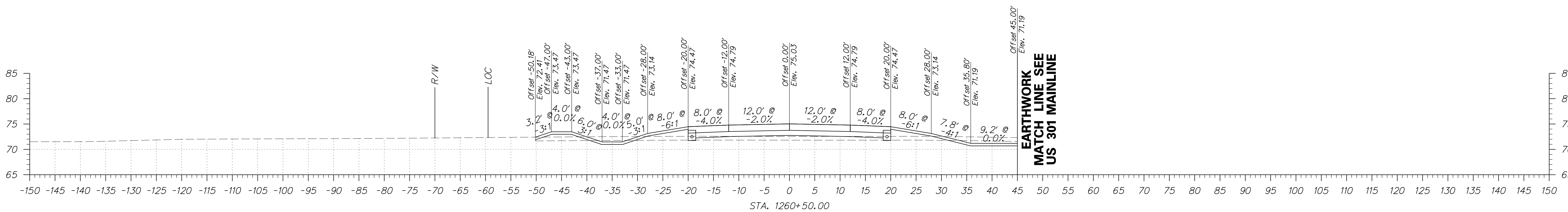

ADDENDUMS / REVISIONS	

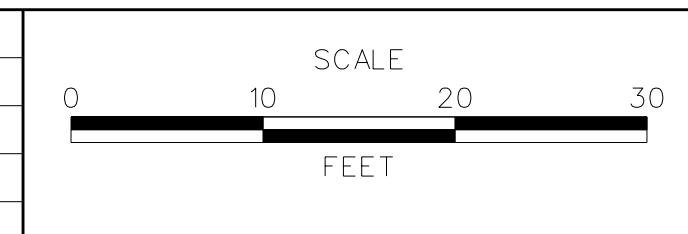

**US 301  
MARYLAND STATE LINE  
TO LEVELS ROAD**

CONTRACT T200811301	BRIDGE NO.
COUNTY NEW CASTLE	DESIGNED BY: PB CHECKED BY: RK

**CROSS SECTIONS  
WARWICK ROAD**

SHEET NO. 234
TOTAL SHTS. 539

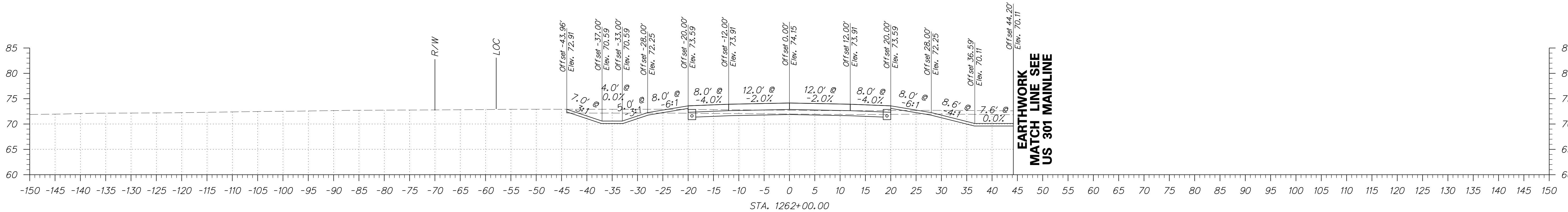
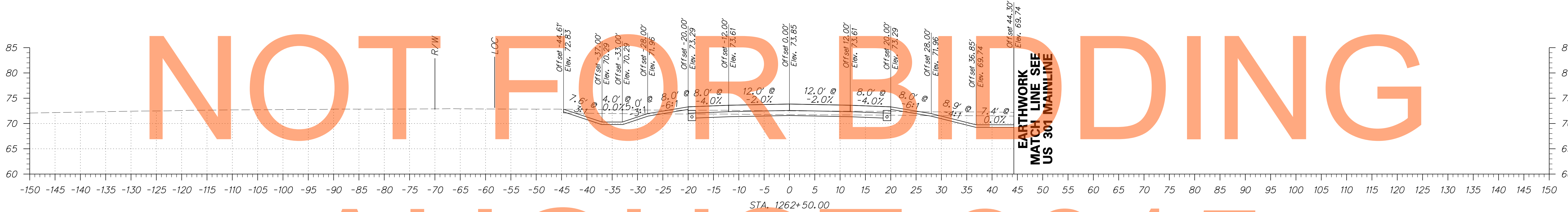
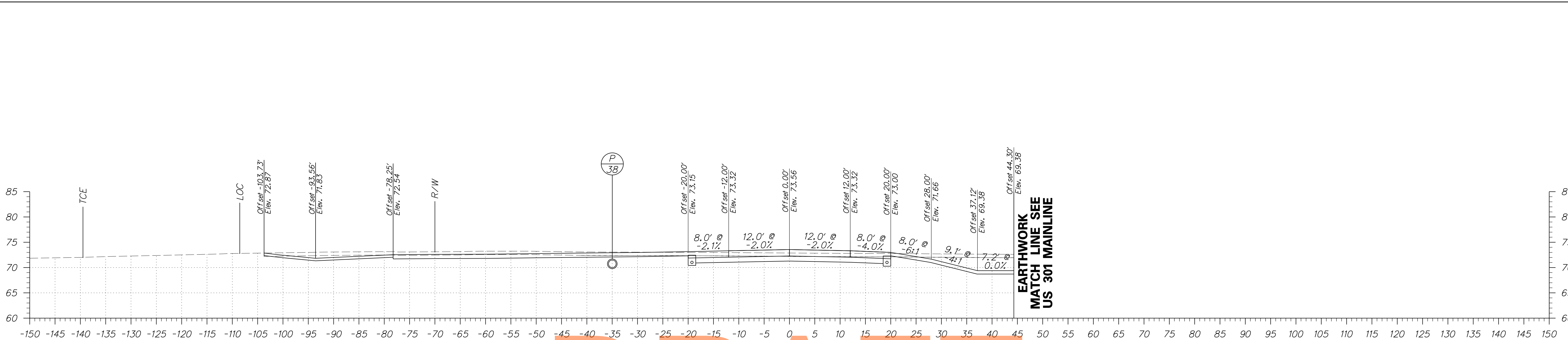

DRAFT

NOT FOR BIDDING

AUGUST 2015

DRAFT

NOT FOR BIDDING

AUGUST 2015

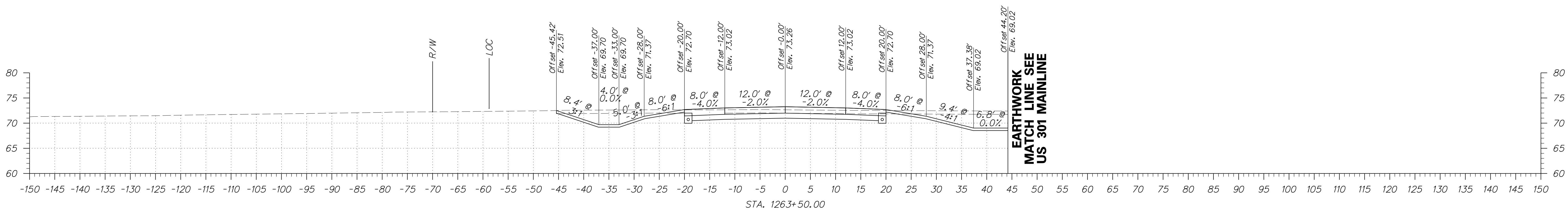
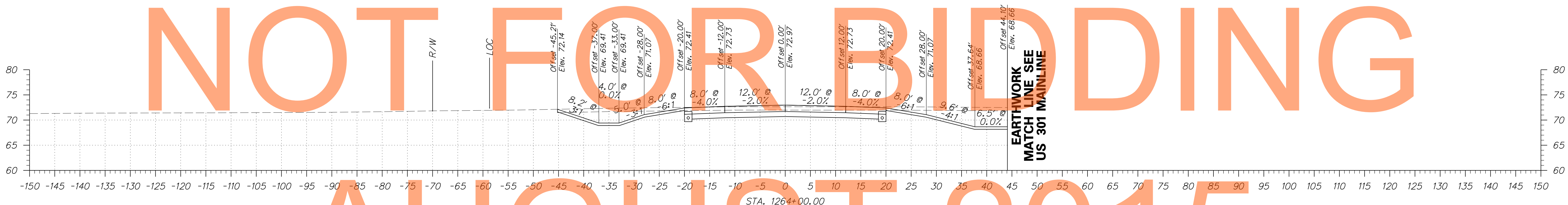
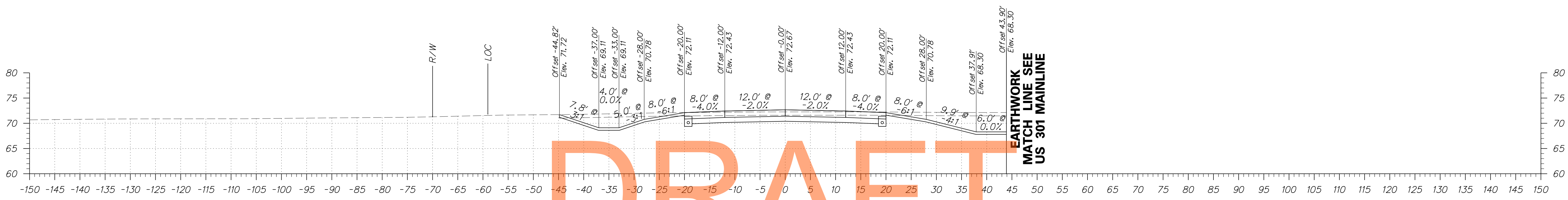

# DRAFT

# NOT FOR BIDDING

# AUGUST 2015

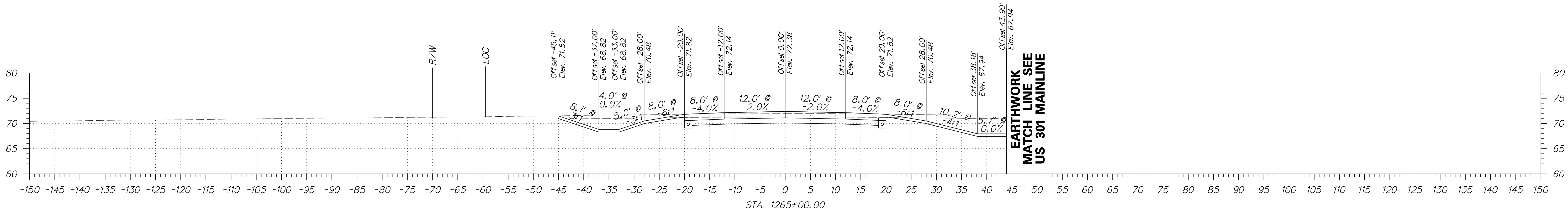
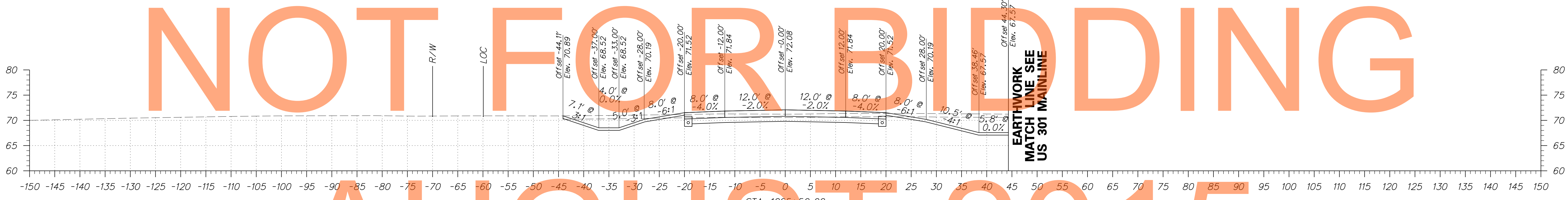
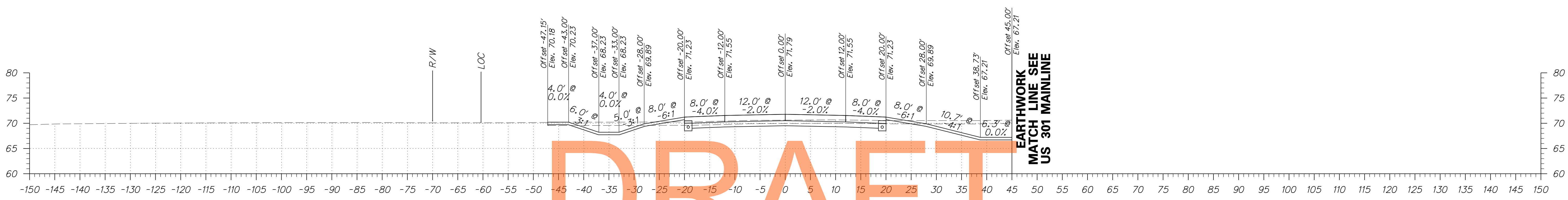

ADDENDUMS / REVISIONS

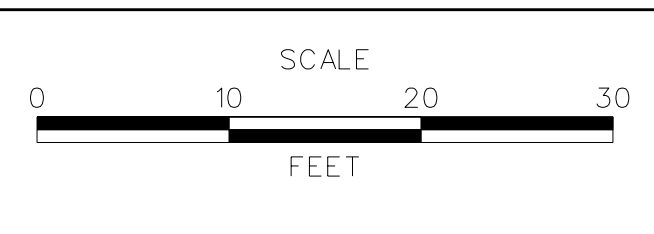

**US 301  
MARYLAND STATE LINE  
TO LEVELS ROAD**

CONTRACT T200811301	BRIDGE NO.
COUNTY NEW CASTLE	DESIGNED BY: PB
	CHECKED BY: RK

<b>CROSS SECTIONS WARWICK ROAD</b>	SHEET NO. 237
	TOTAL SHTS. 539

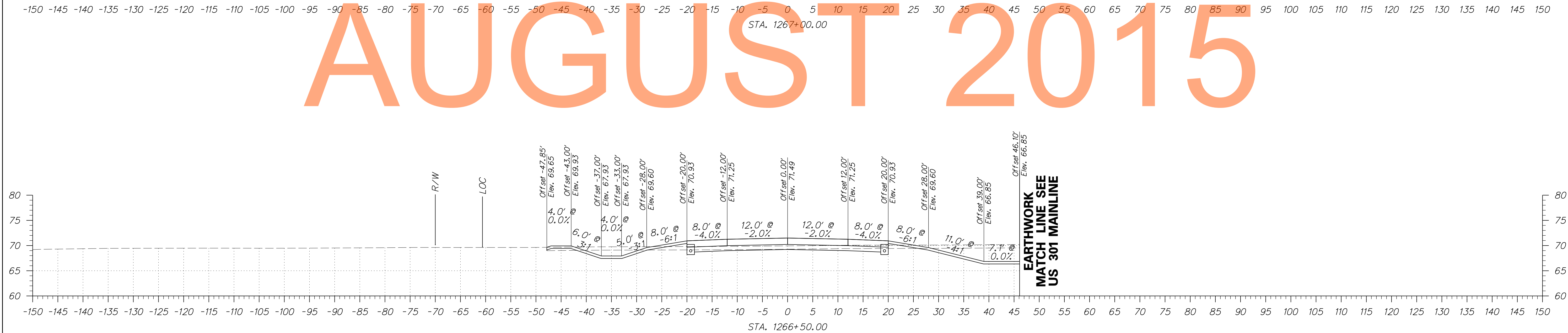
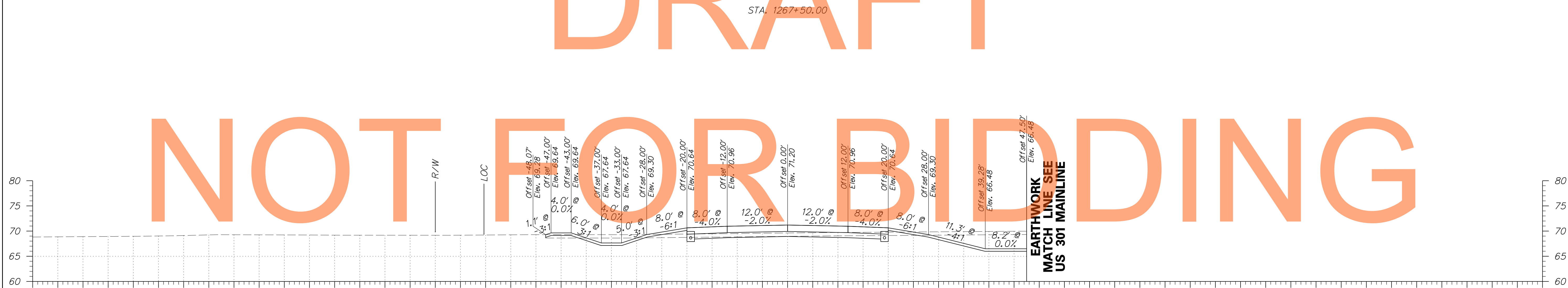
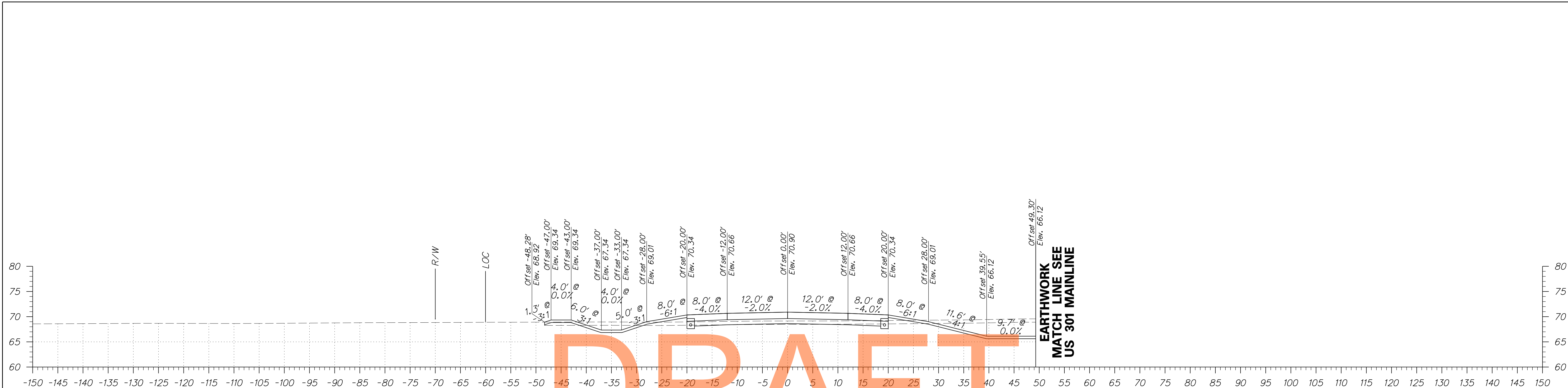

NOT FOR BIDDING

AUGUST 2015

ADDENDUMS / REVISIONS	

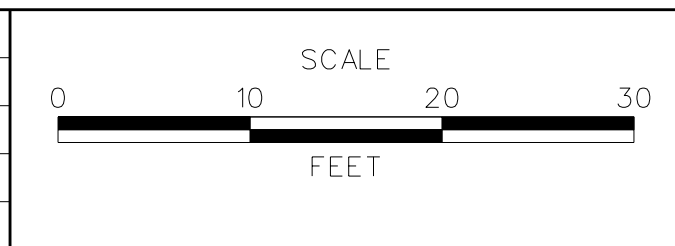

**US 301**  
**MARYLAND STATE LINE**  
**TO LEVELS ROAD**

CONTRACT T200811301	BRIDGE NO.
COUNTY NEW CASTLE	DESIGNED BY: PB
	CHECKED BY: RK

<b>CROSS SECTIONS</b> <b>WARWICK ROAD</b>	SHEET NO. 238
	TOTAL SHTS. 539

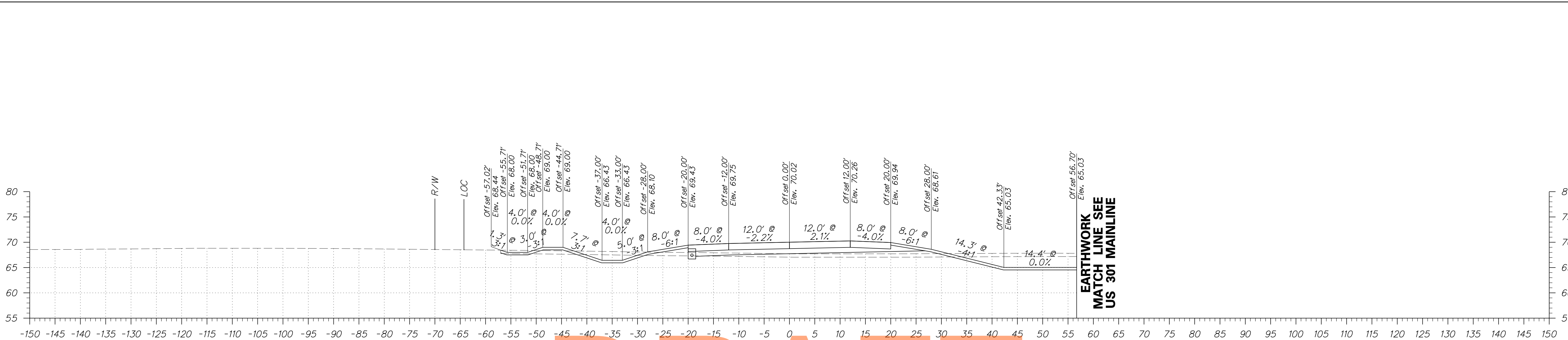

DRAFT

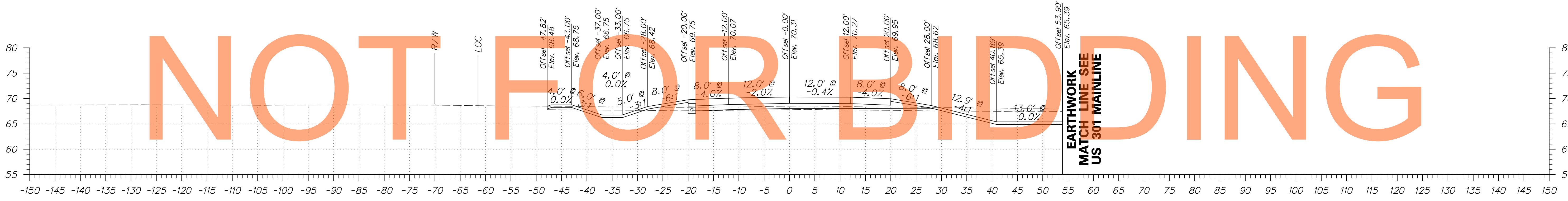

AUGUST 2015

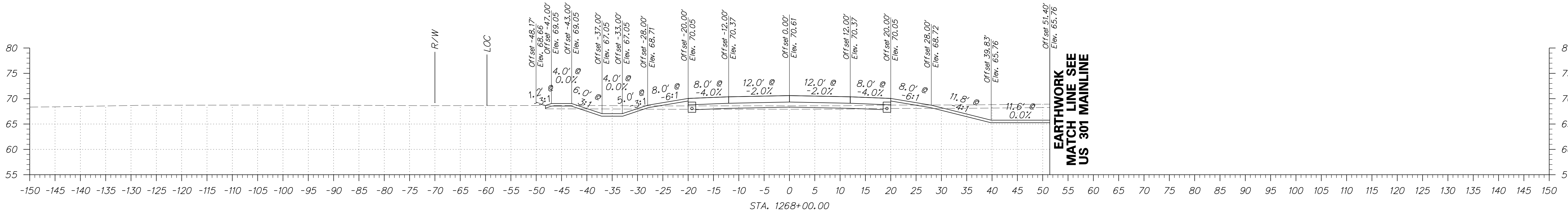

ADDENDUMS / REVISIONS	

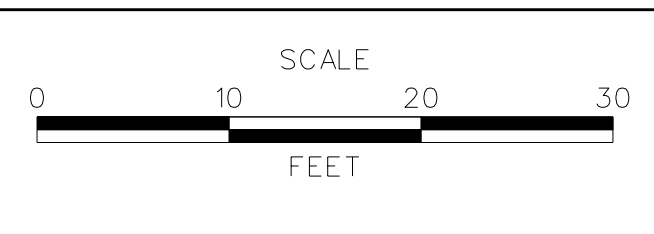

US 301  
MARYLAND STATE LINE  
TO LEVELS ROAD

CONTRACT T200811301	BRIDGE NO.
COUNTY NEW CASTLE	DESIGNED BY: PB CHECKED BY: RK

CROSS SECTIONS WARWICK ROAD	SHEET NO. 239
	TOTAL SHTS. 539

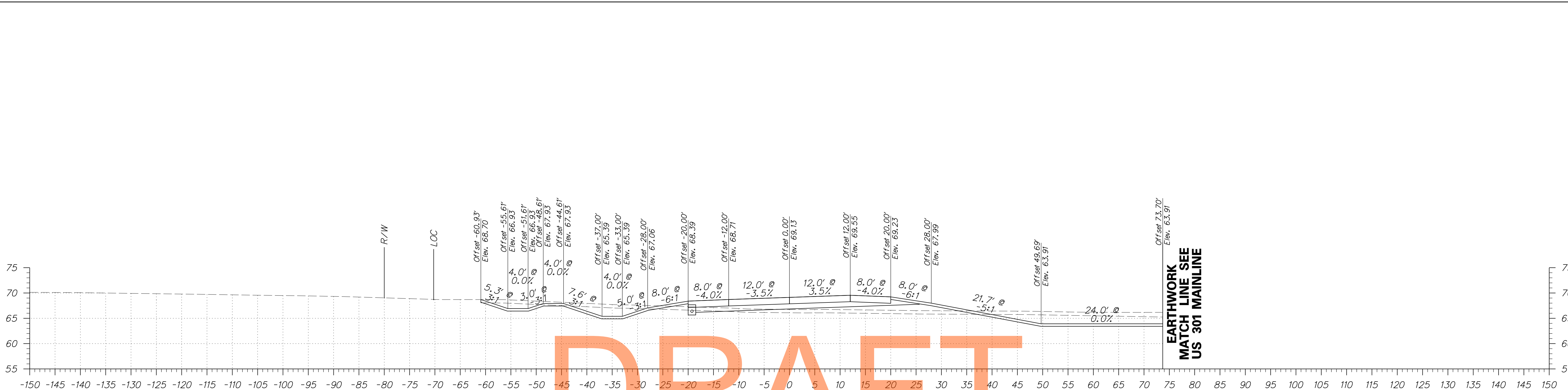

DRAFT

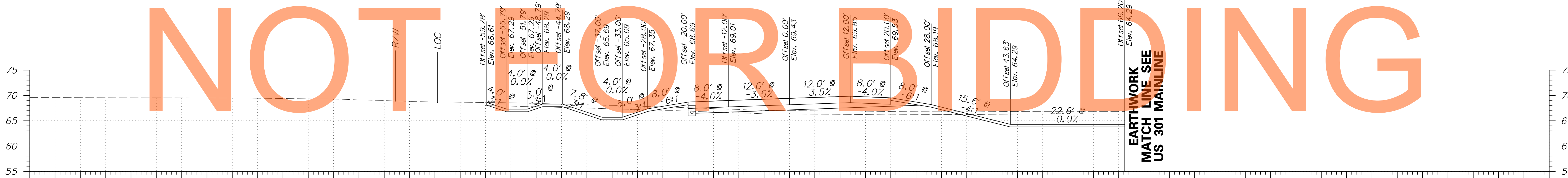

NOT FOR BIDDING

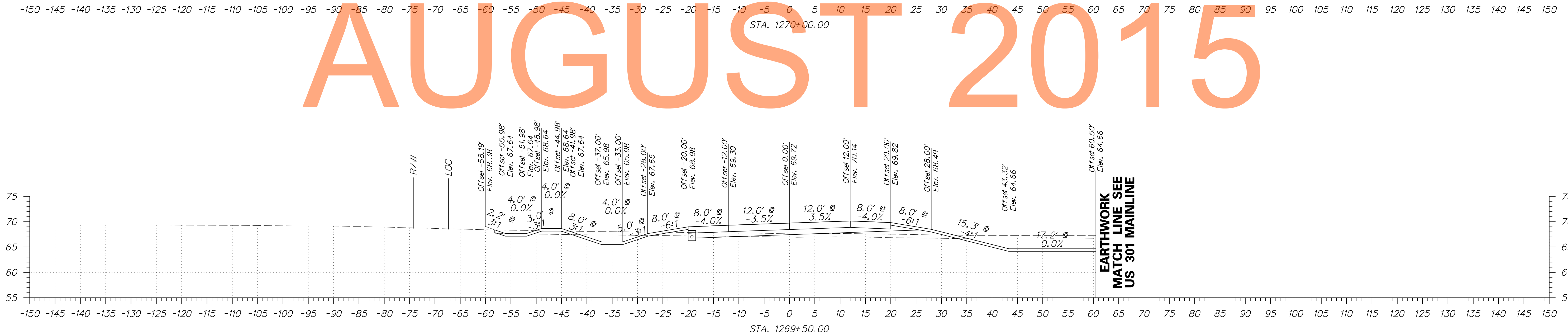

AUGUST 2015



ADDENDUMS / REVISIONS	

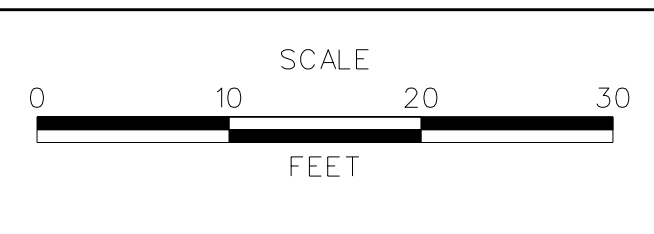

**US 301  
MARYLAND STATE LINE  
TO LEVELS ROAD**

CONTRACT T200811301	BRIDGE NO. 
COUNTY NEW CASTLE	DESIGNED BY: PB CHECKED BY: RK

<b>CROSS SECTIONS WARWICK ROAD</b>	SHEET NO. 240
	TOTAL SHTS. 539



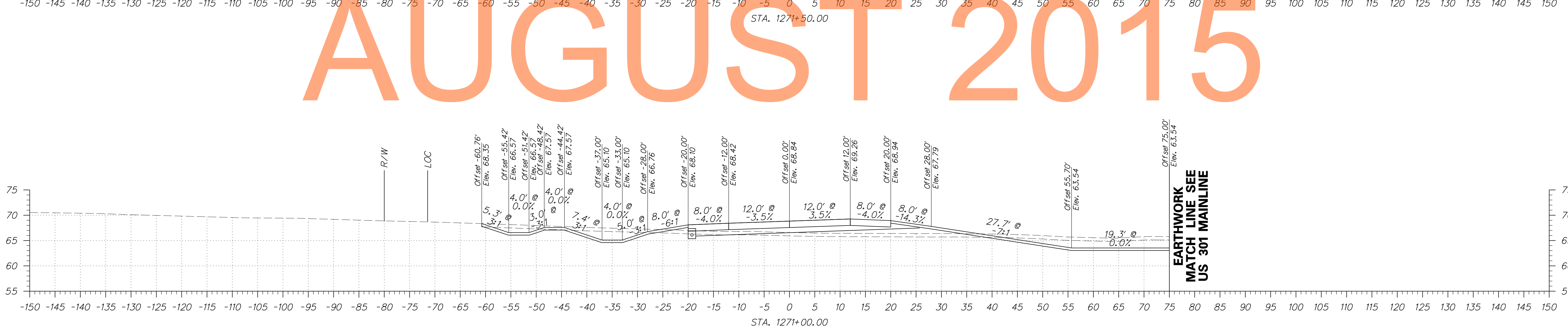
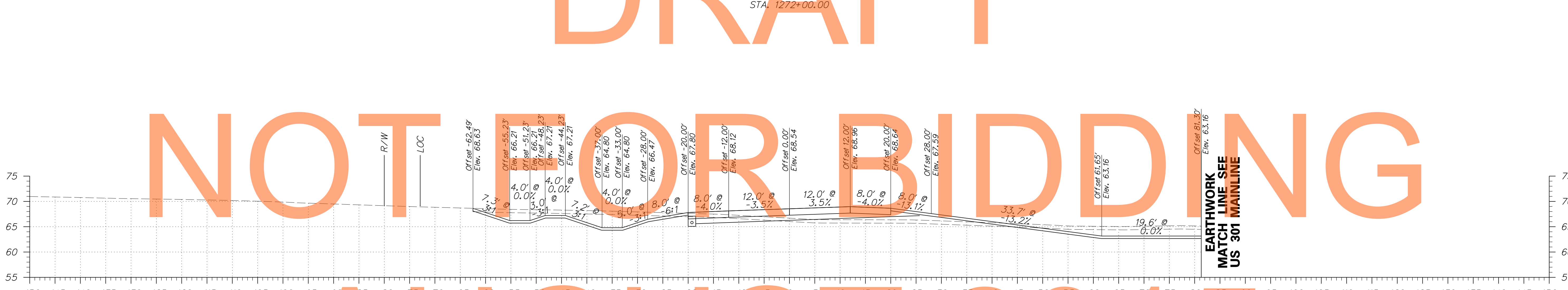
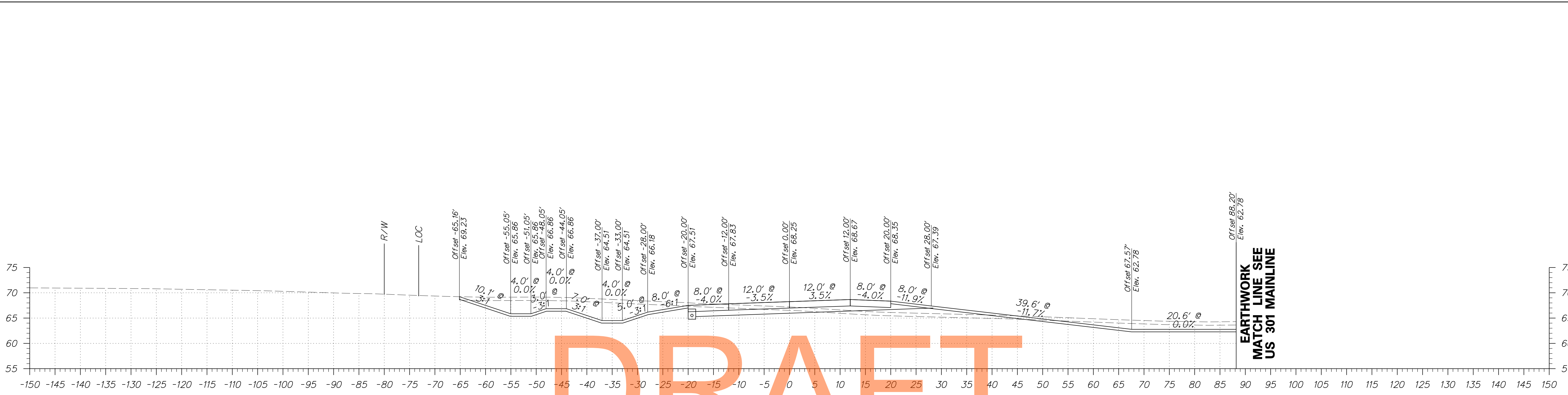

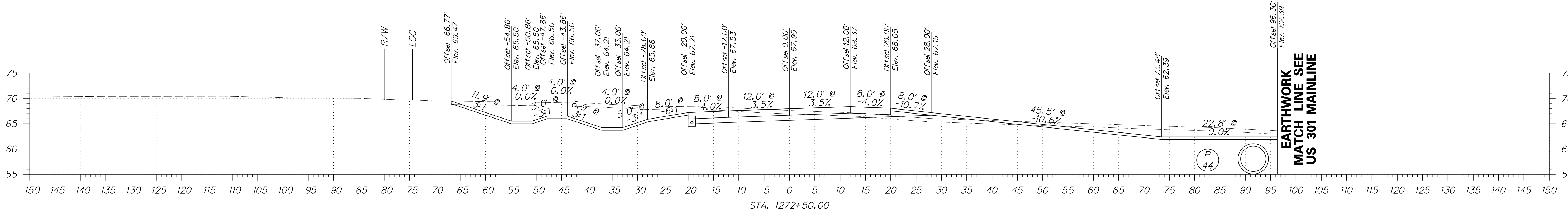
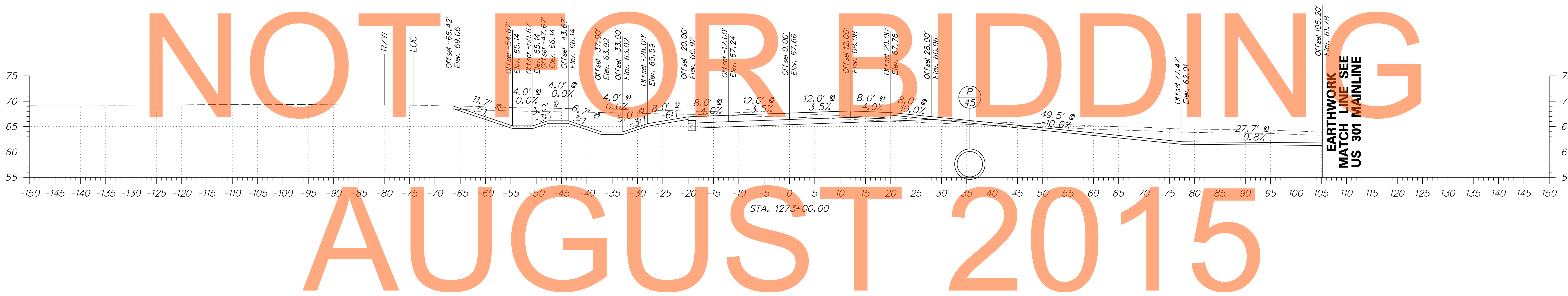
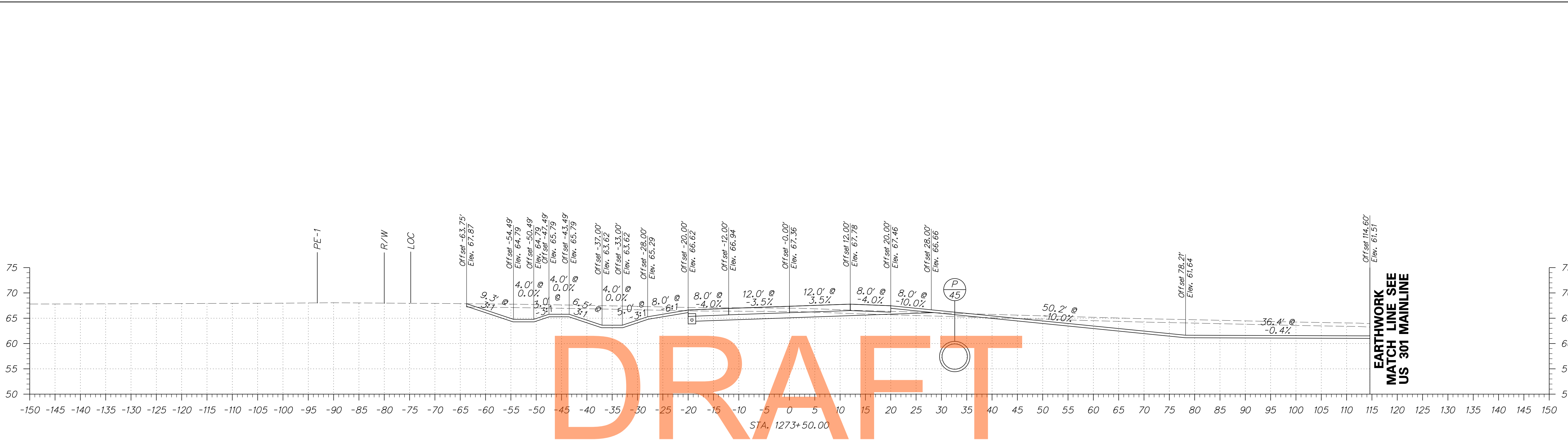

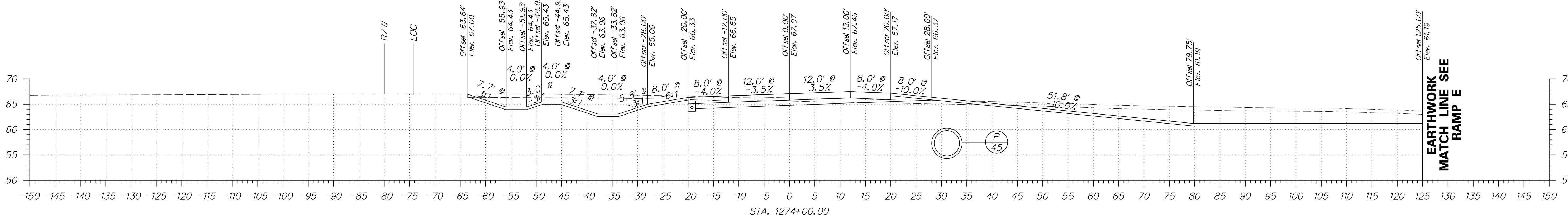
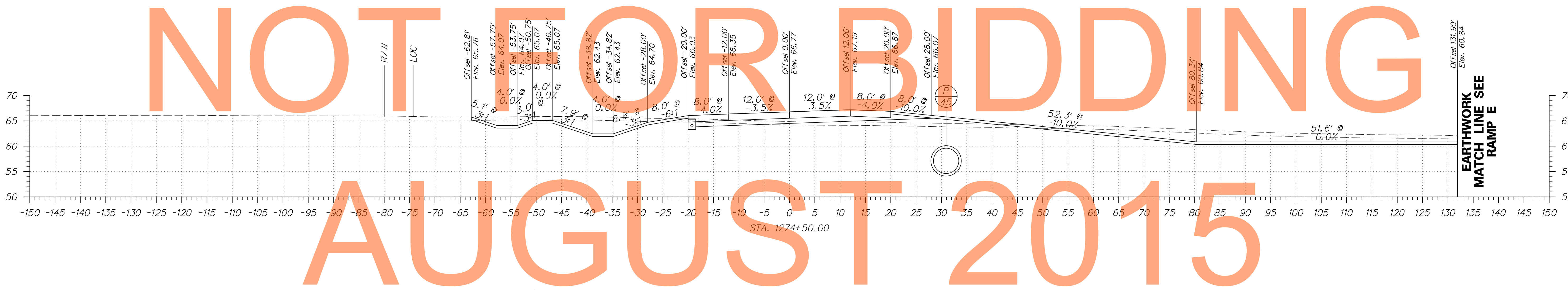
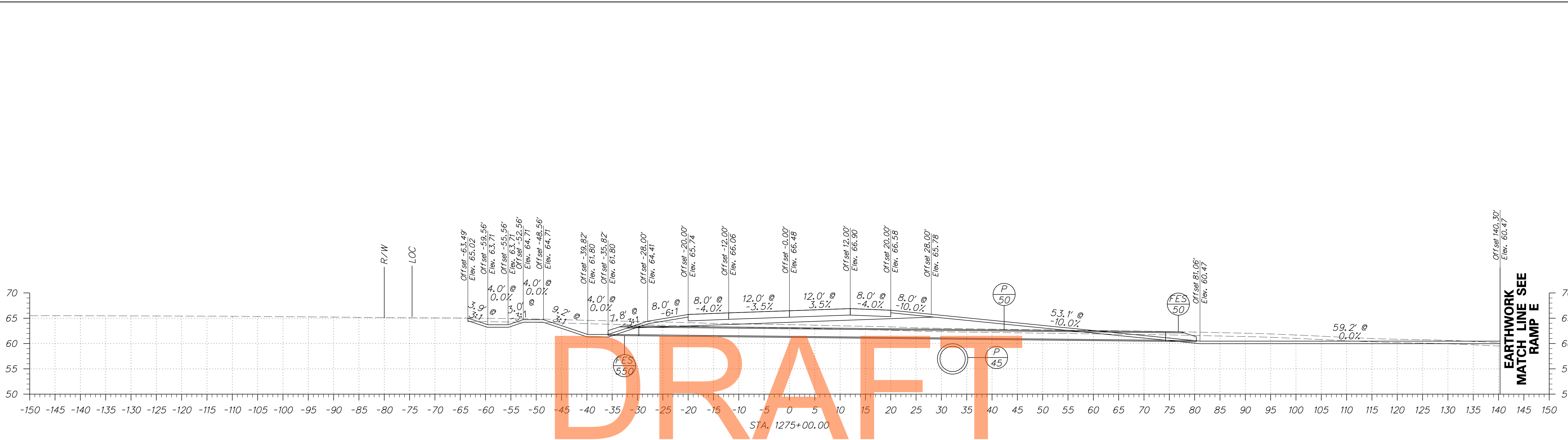

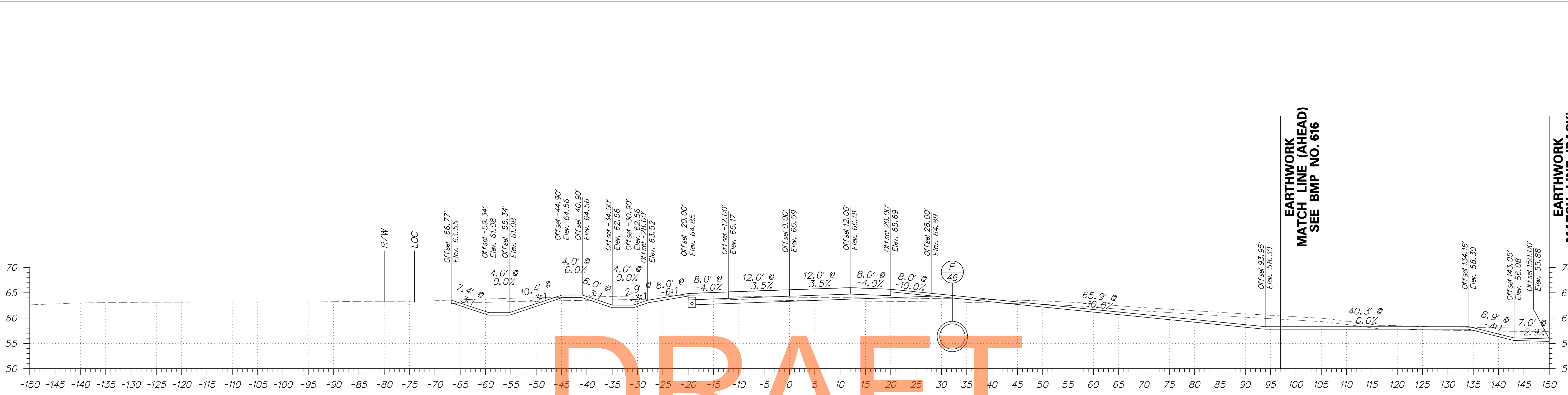

DRAFT

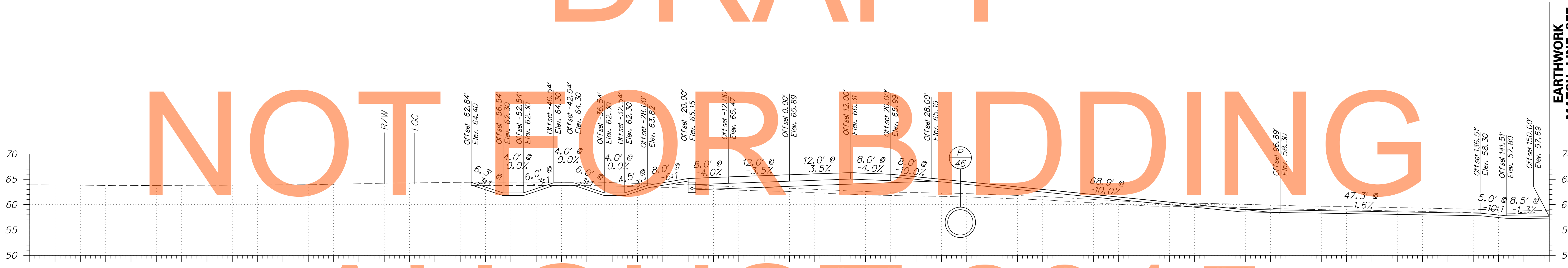

AUGUST 2015

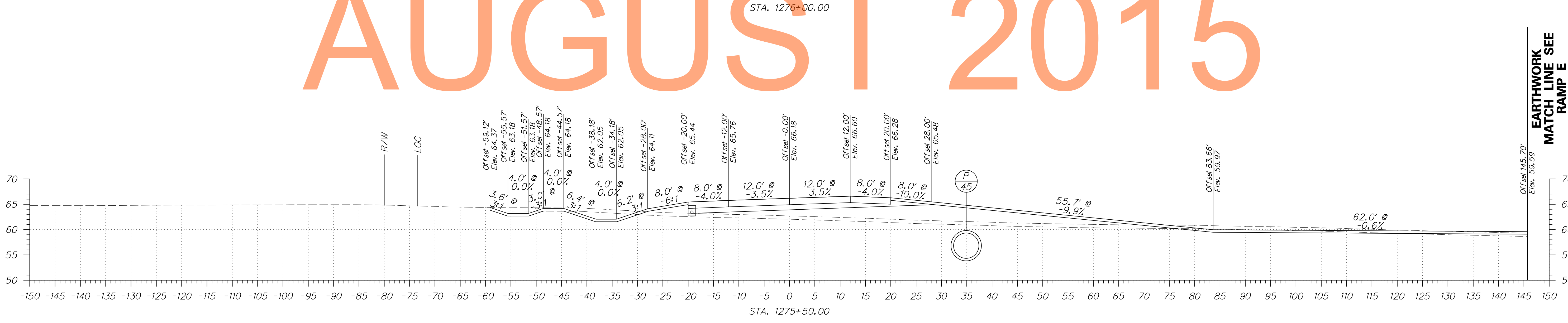

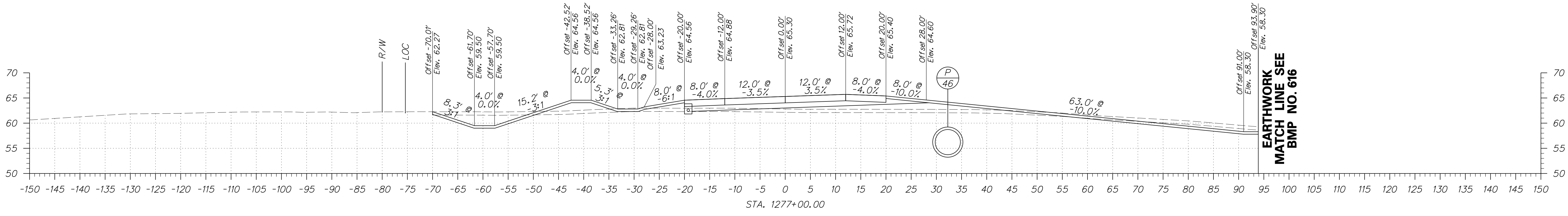
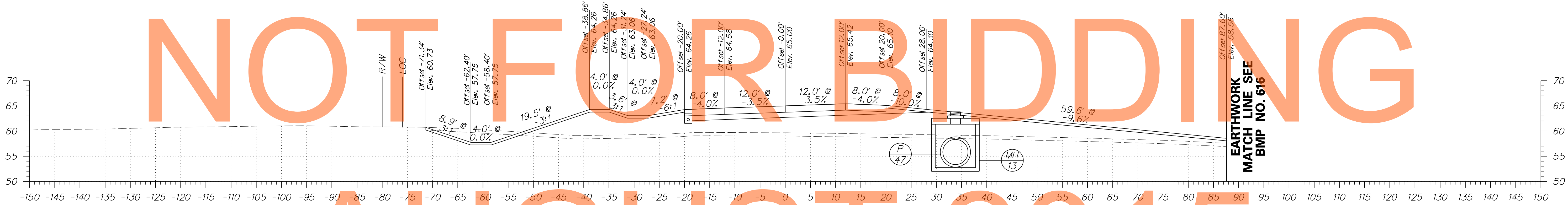
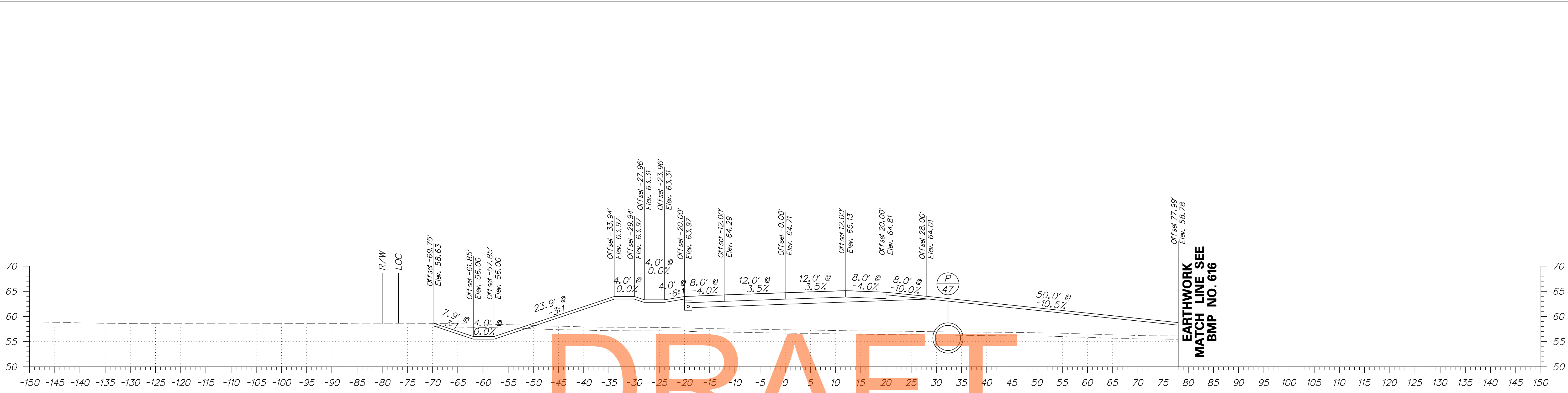

DRAFT

NOT FOR BIDDING

AUGUST 2015

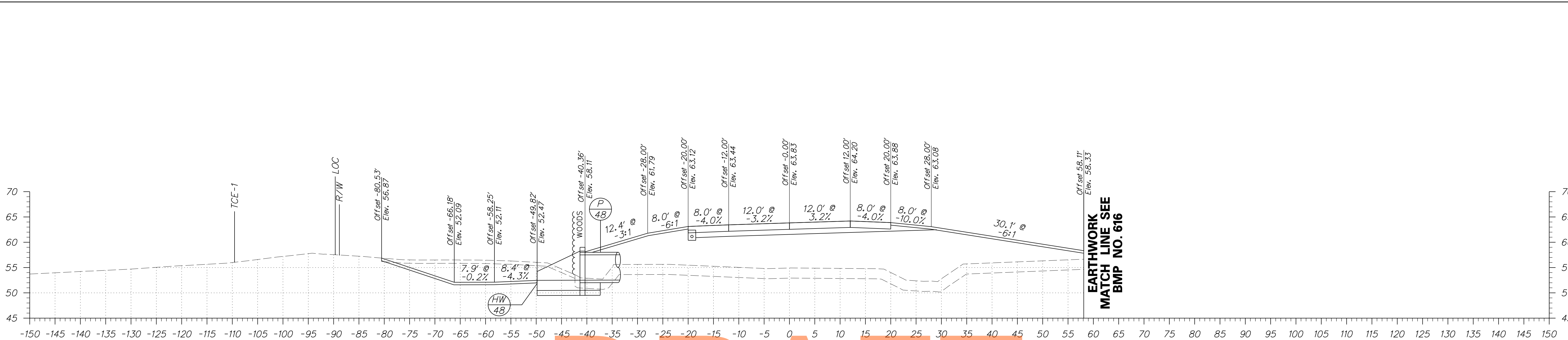

DRAFT

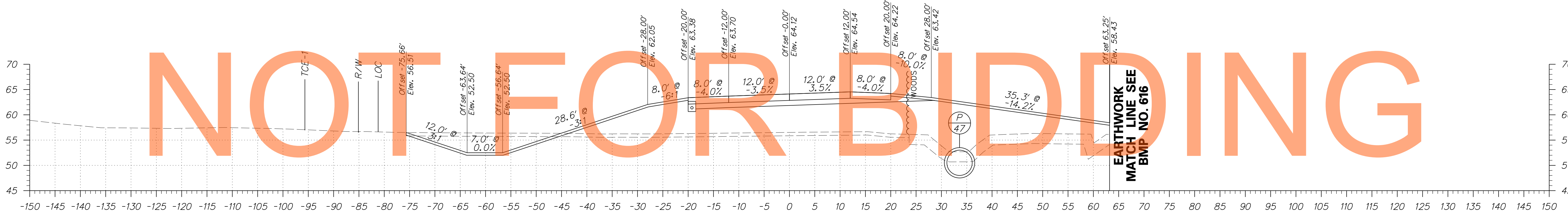

AUGUST 2015

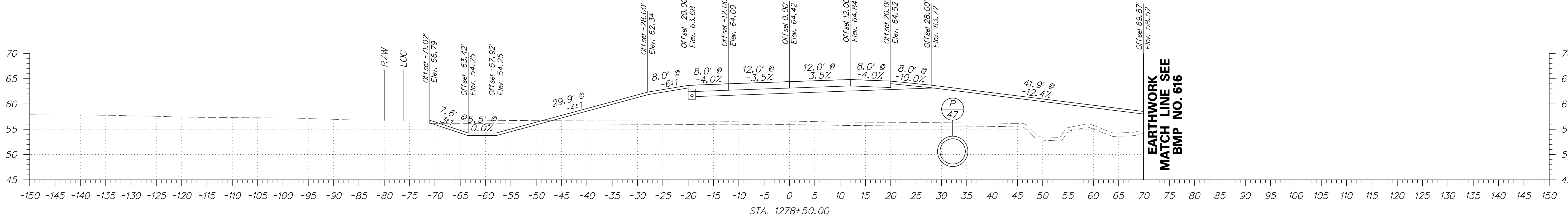

ADDENDUMS / REVISIONS	

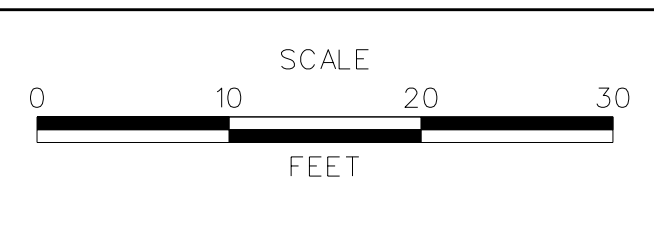

US 301  
MARYLAND STATE LINE  
TO LEVELS ROAD

CONTRACT T200811301	BRIDGE NO.
COUNTY NEW CASTLE	DESIGNED BY: PB CHECKED BY: RK

CROSS SECTIONS WARWICK ROAD	SHEET NO. 246
	TOTAL SHTS. 539

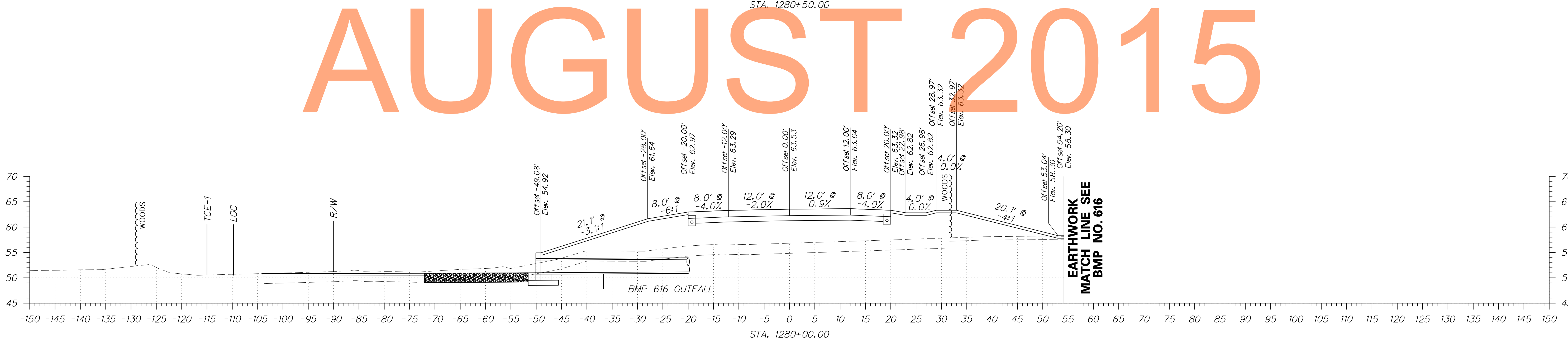
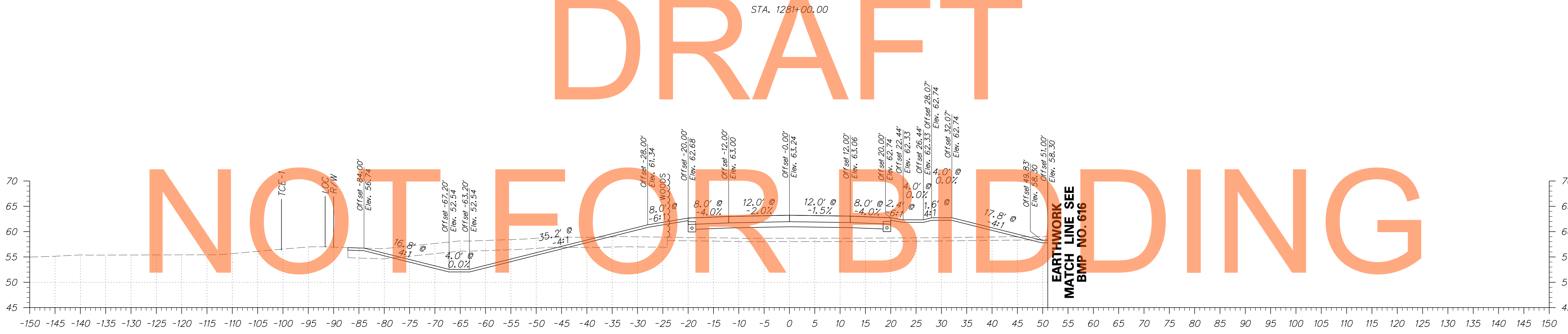
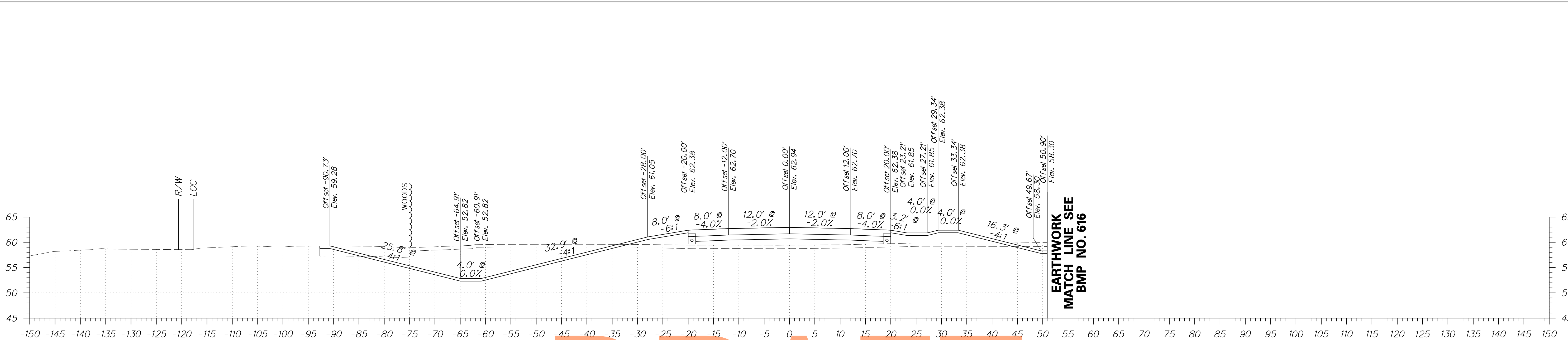

DRAFT

NOT FOR BIDDING

AUGUST 2015

ADDENDUMS / REVISIONS	

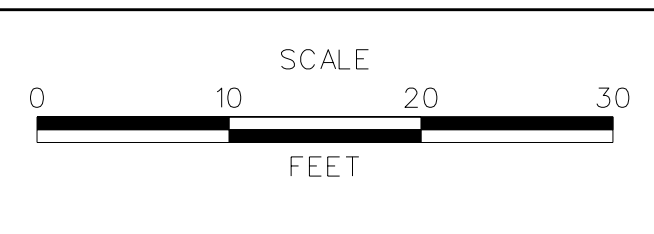

**US 301**  
**MARYLAND STATE LINE**  
**TO LEVELS ROAD**

CONTRACT T200811301	BRIDGE NO. 
COUNTY NEW CASTLE	DESIGNED BY: PB CHECKED BY: RK

<b>CROSS SECTIONS</b> <b>WARWICK ROAD</b>
SHEET NO. 247
TOTAL SHTS. 539

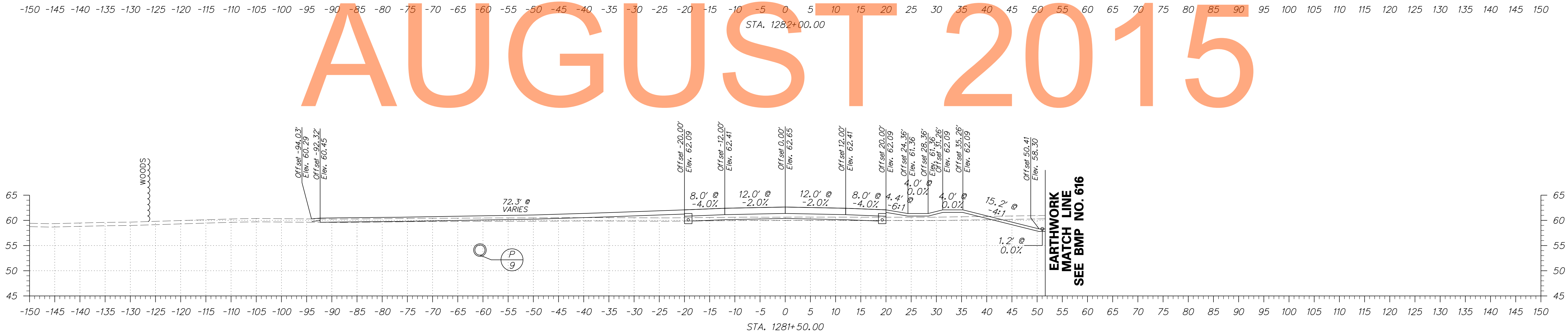
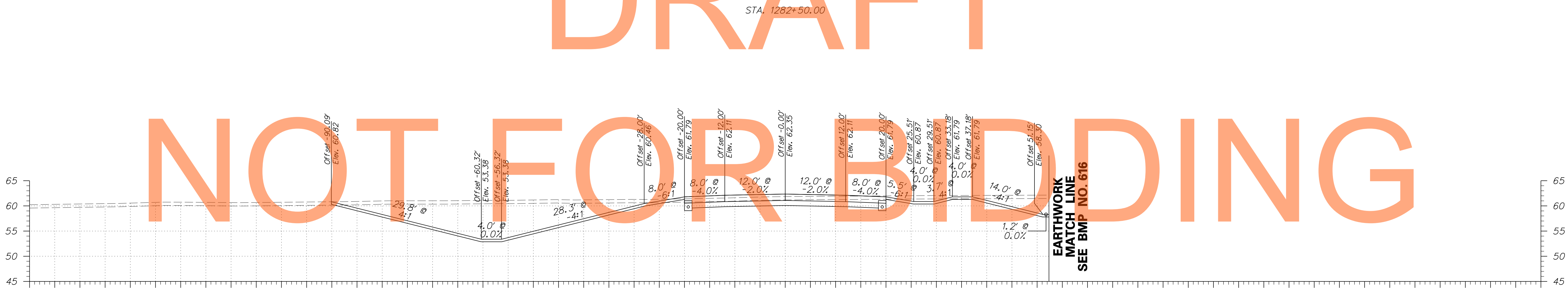
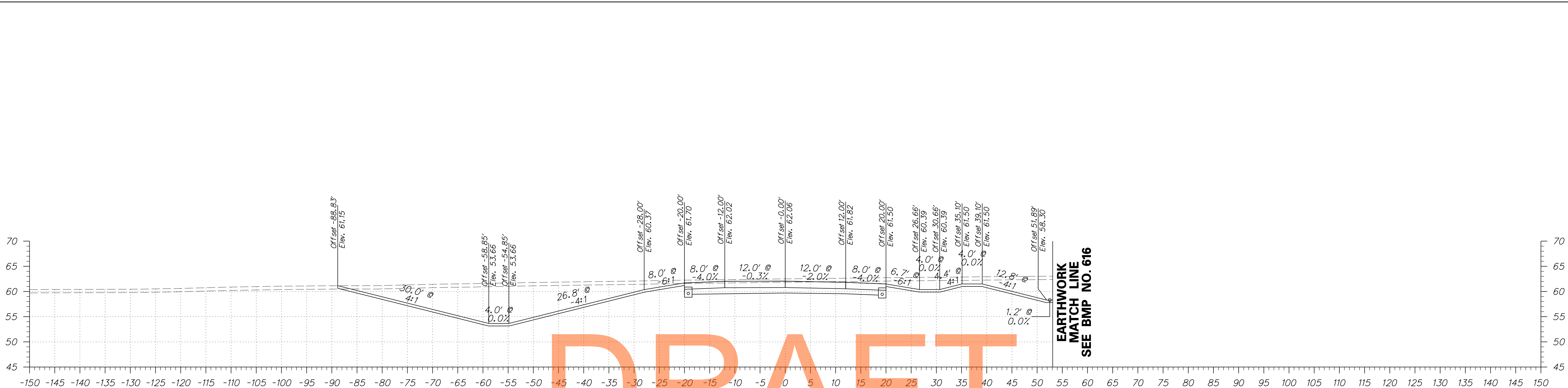

DRAFT

NOT FOR BIDDING

AUGUST 2015



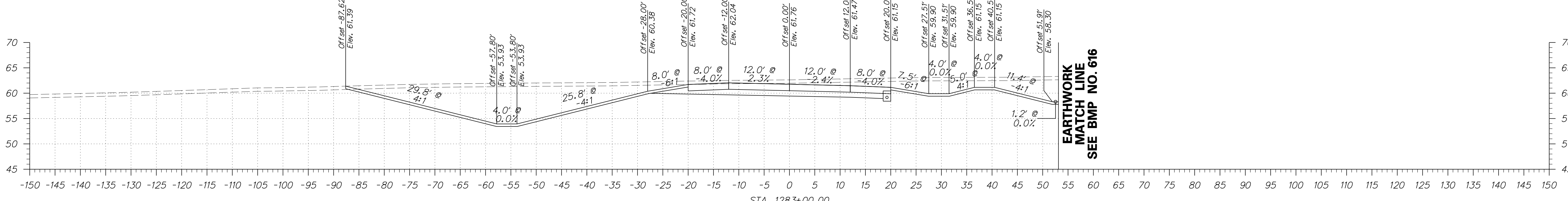
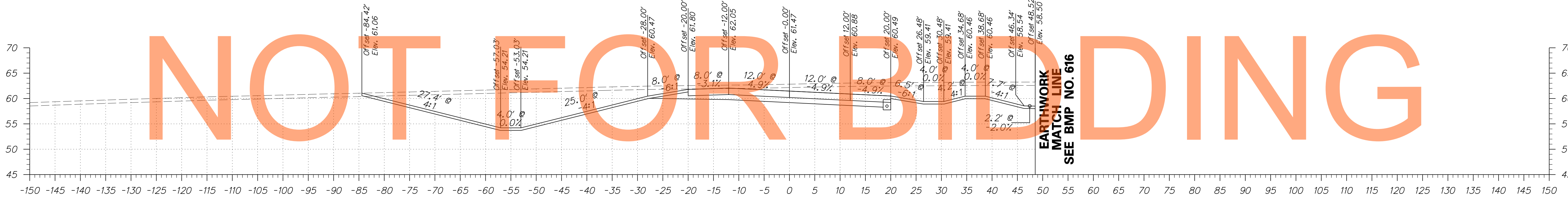
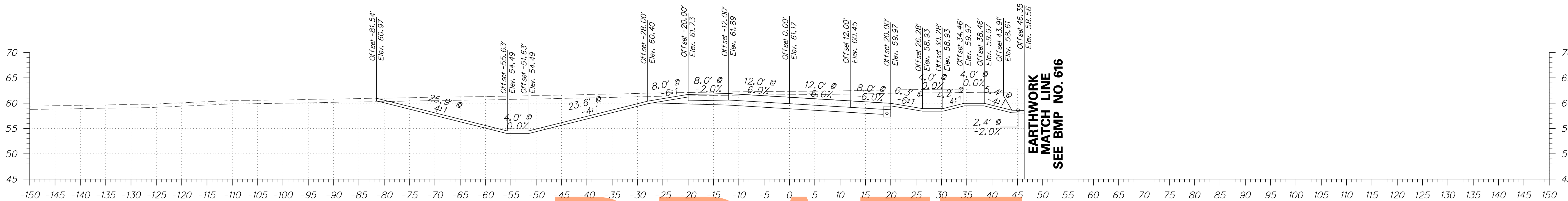

DRAFT

NOT FOR BIDDING

AUGUST 2015



ADDENDUMS / REVISIONS	

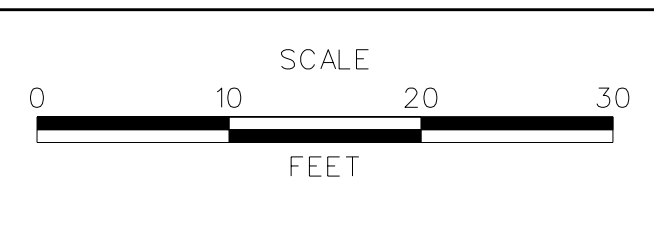

**US 301  
MARYLAND STATE LINE  
TO LEVELS ROAD**

CONTRACT T200811301	BRIDGE NO. 
COUNTY NEW CASTLE	DESIGNED BY: PB CHECKED BY: RK

<b>CROSS SECTIONS WARWICK ROAD</b>	SHEET NO. 249
	TOTAL SHTS. 539

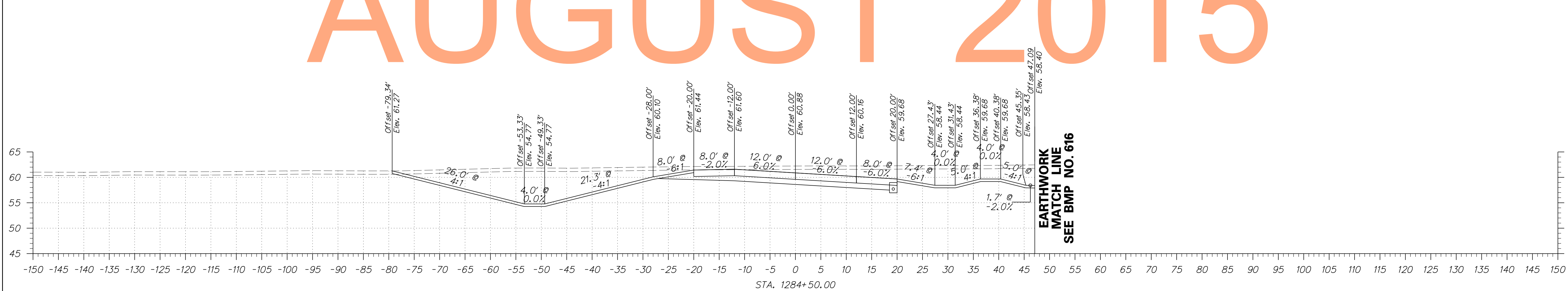
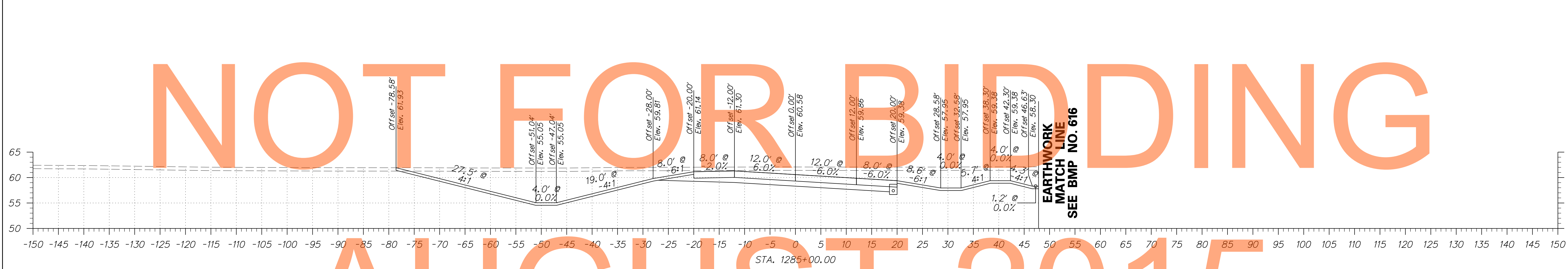
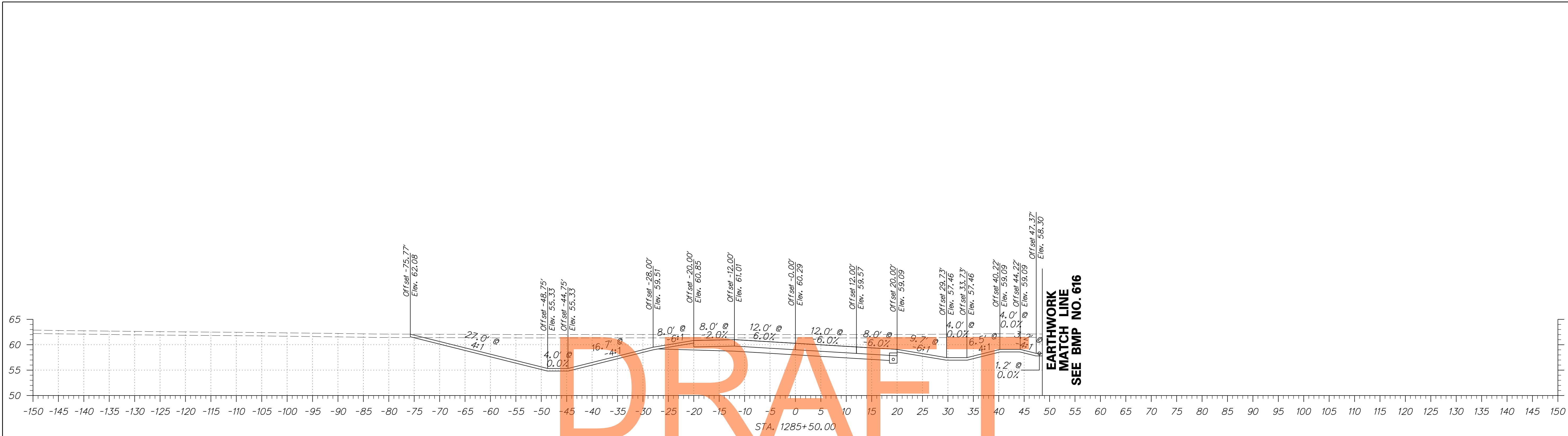

DRAFT

NOT FOR BIDDING

AUGUST 2015

ADDENDUMS / REVISIONS	

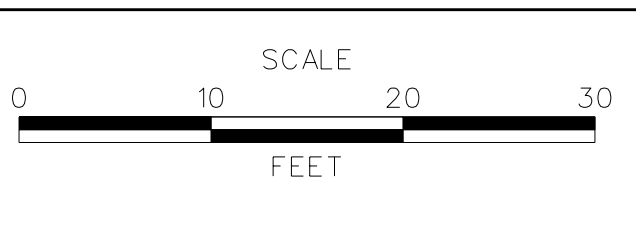

**US 301**  
**MARYLAND STATE LINE**  
**TO LEVELS ROAD**

CONTRACT T200811301	BRIDGE NO.
COUNTY NEW CASTLE	DESIGNED BY: PB
	CHECKED BY: RK

**CROSS SECTIONS**  
**WARWICK ROAD**

SHEET NO.	250
TOTAL SHTS.	539

# DRAFT

# NOT FOR BIDDING

# AUGUST 2015

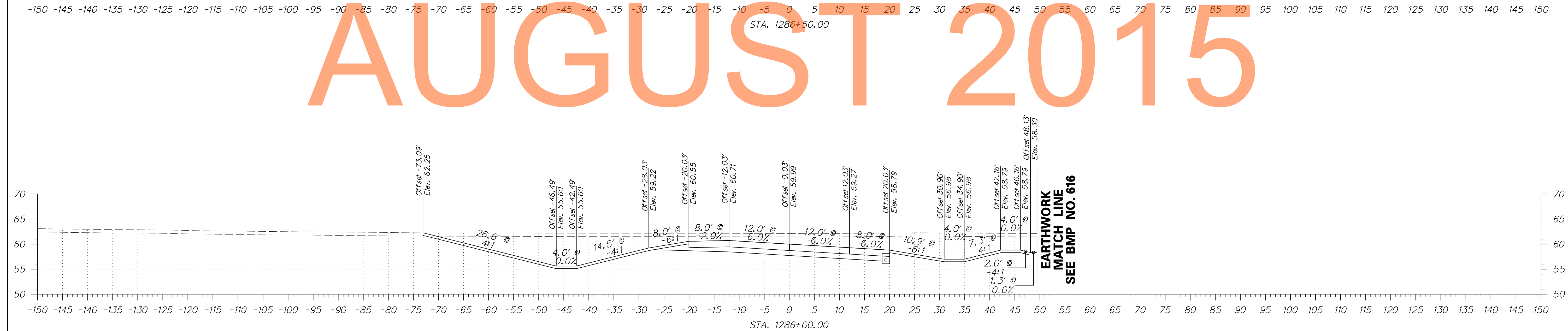
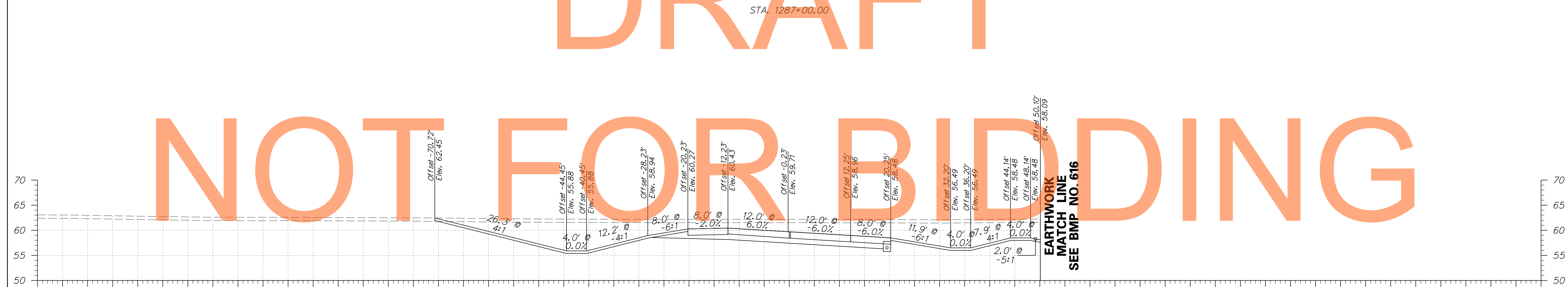
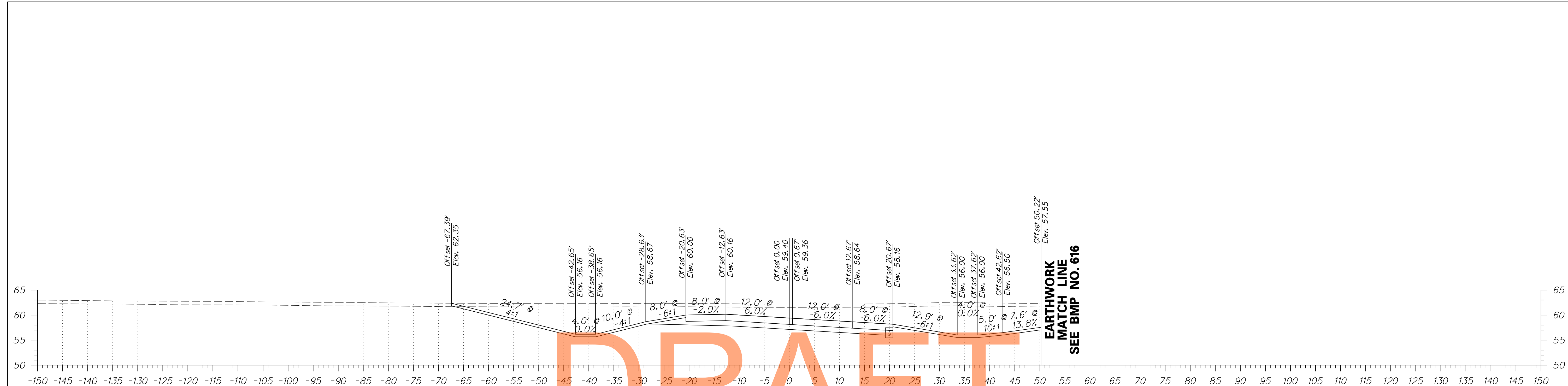

ADDENDUMS / REVISIONS

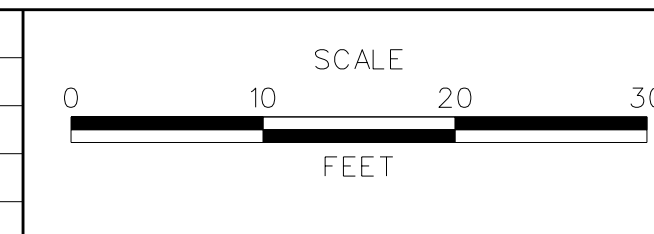

**US 301**  
**MARYLAND STATE LINE**  
**TO LEVELS ROAD**

CONTRACT T200811301	BRIDGE NO.
COUNTY NEW CASTLE	DESIGNED BY: PB CHECKED BY: RK

<b>CROSS SECTIONS</b> <b>WARWICK ROAD</b>	SHEET NO. 251 TOTAL SHTS. 539
--	--

DRAFT

NOT FOR BIDDING

AUGUST 2015

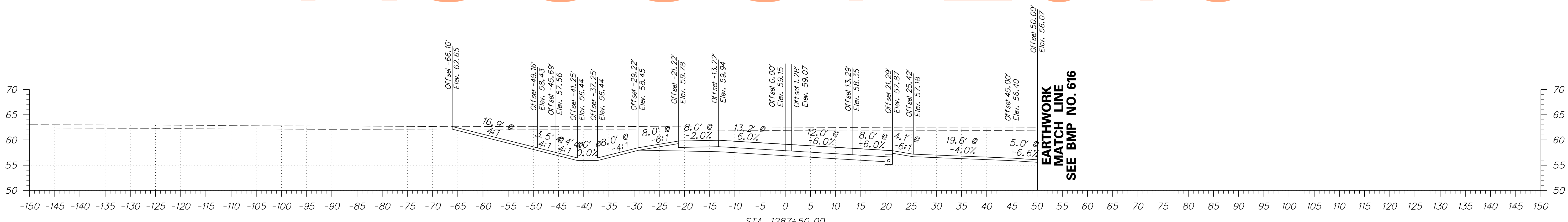
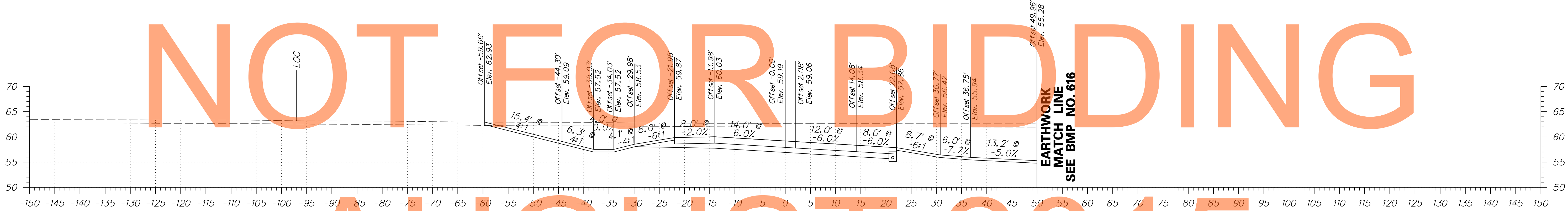
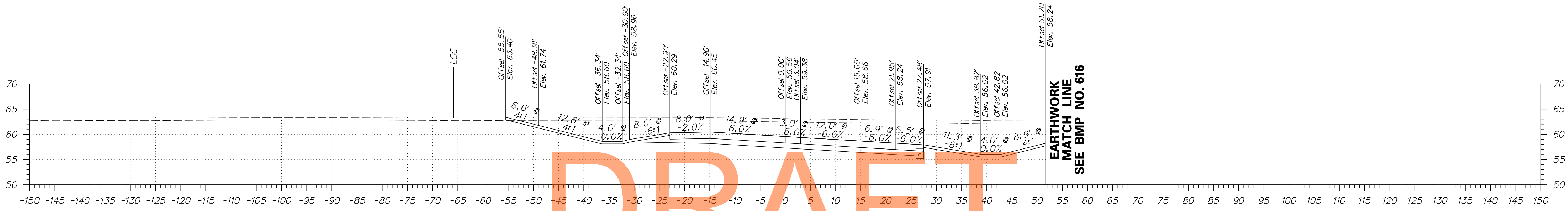

ADDENDUMS / REVISIONS	

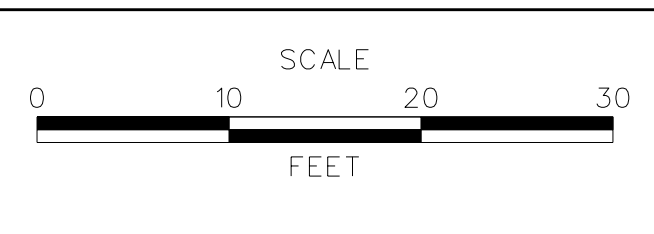

US 301  
MARYLAND STATE LINE  
TO LEVELS ROAD

CONTRACT T200811301	BRIDGE NO.
COUNTY NEW CASTLE	DESIGNED BY: PB CHECKED BY: RK

CROSS SECTIONS WARWICK ROAD	SHEET NO. 252
	TOTAL SHTS. 539

# DRAFT

# NOT FOR BIDDING

# AUGUST 2015

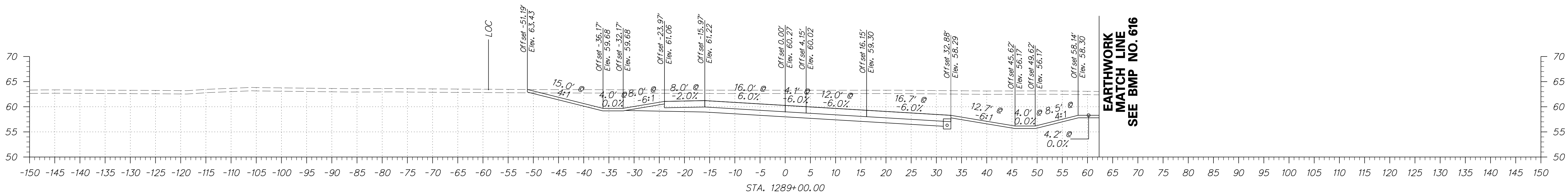
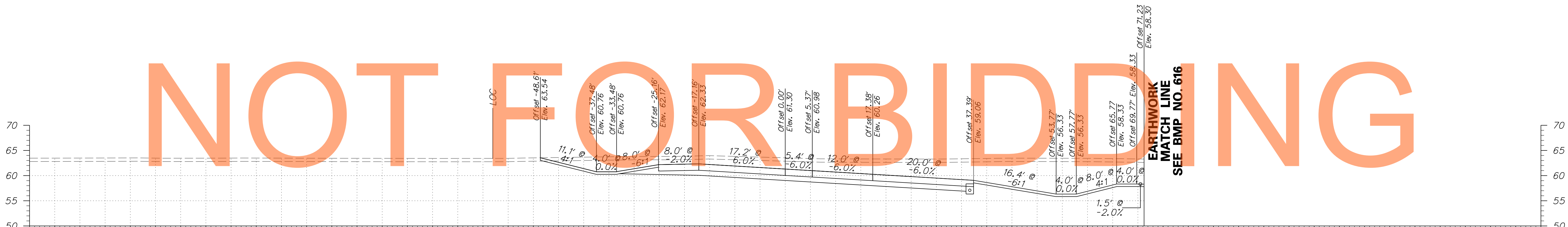
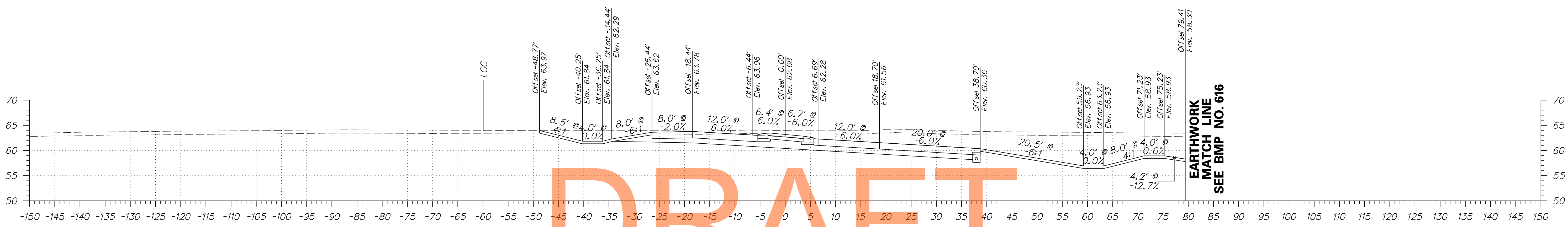

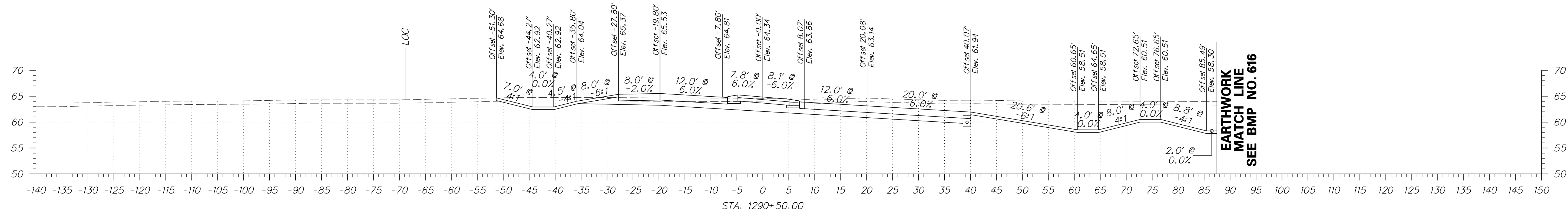
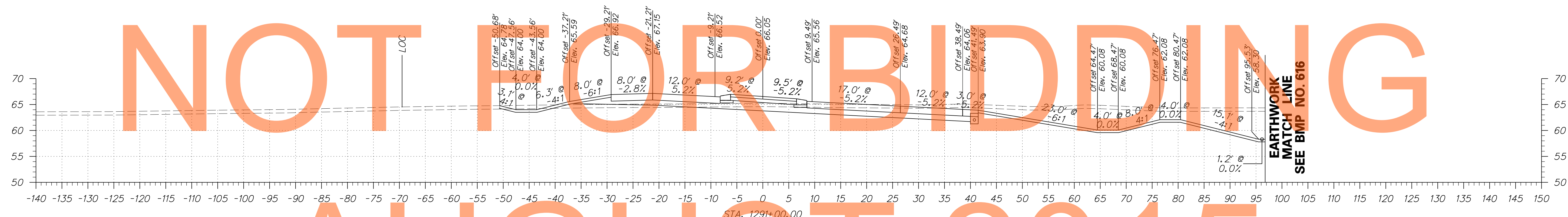
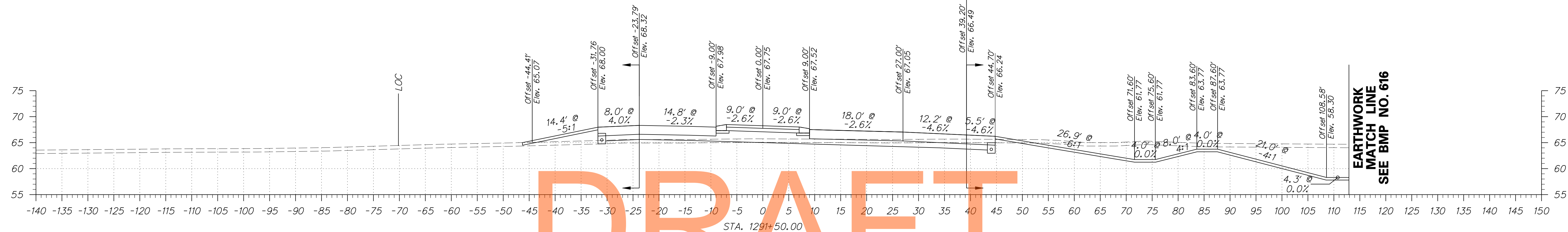

DRAFT

NOT FOR BIDDING

AUGUST 2015

# DRAFT

# NOT FOR BIDDING

# AUGUST 2015

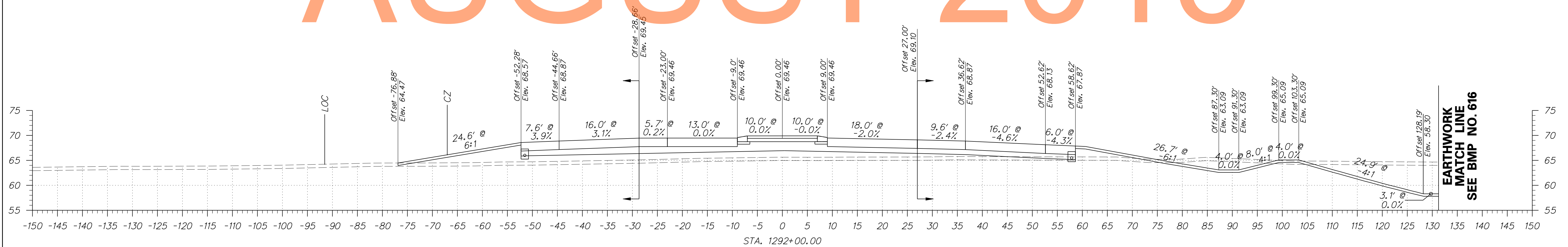

# DRAFT

# NOT FOR BIDDING

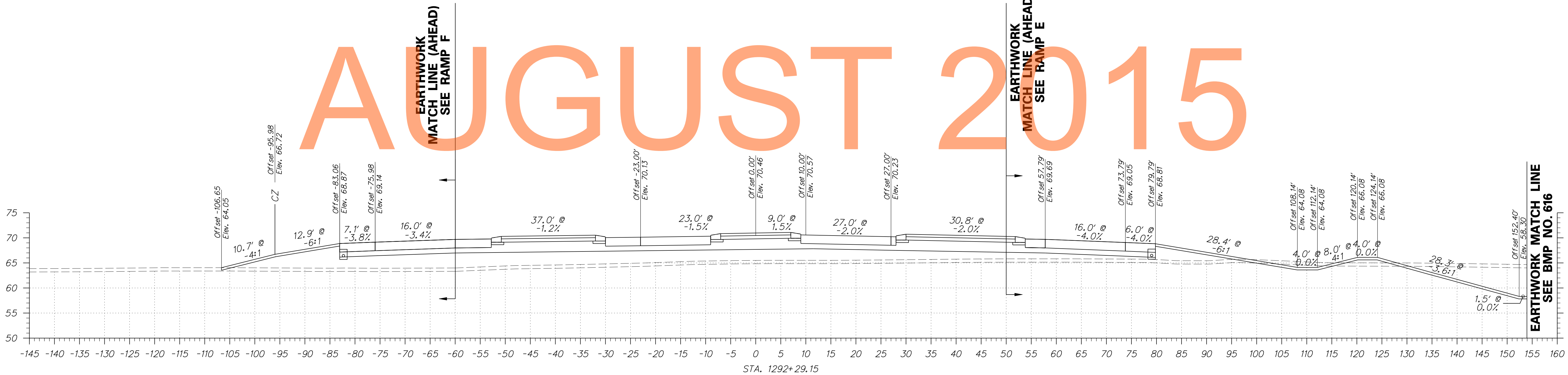
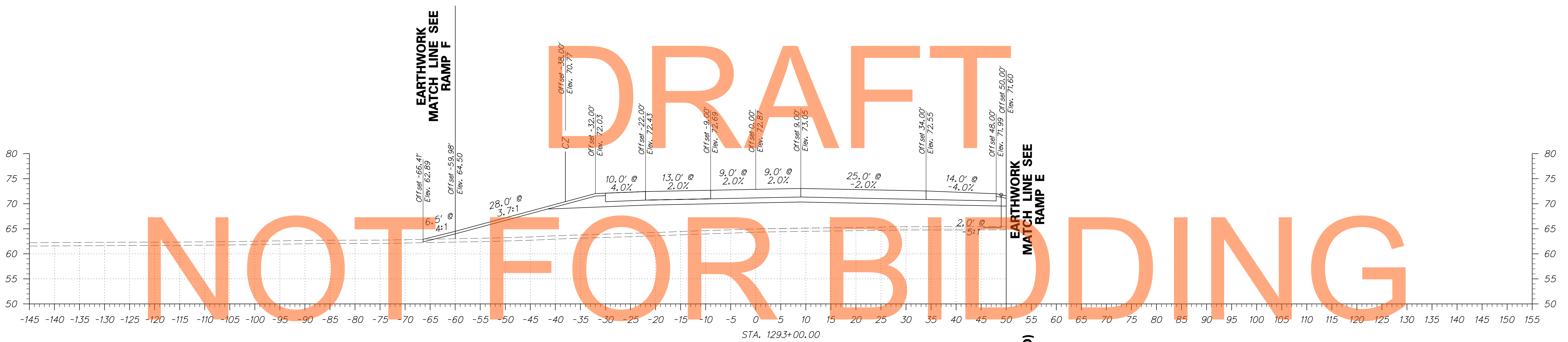



# DRAFT

# NOT FOR BIDDING

# AUGUST 2015

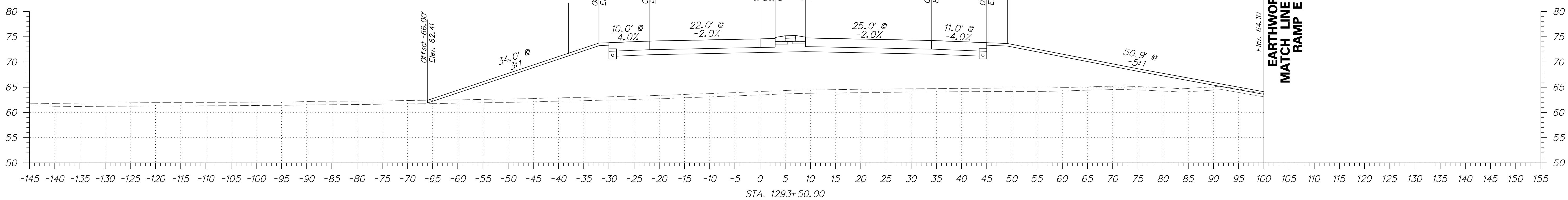
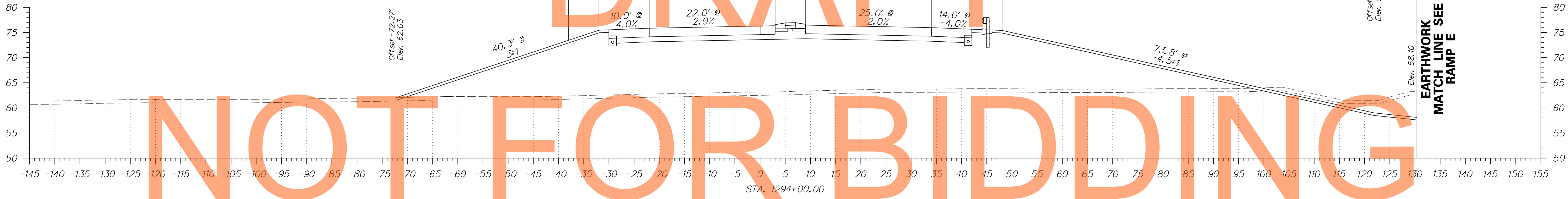

<p><b>DELAWARE</b> DEPARTMENT OF TRANSPORTATION</p>	ADDENDUMS / REVISIONS		<p>SCALE</p> <p>FEET</p>	<p><b>US 301</b> <b>MARYLAND STATE LINE</b> <b>TO LEVELS ROAD</b></p>		CONTRACT	BRIDGE NO.	<p><b>CROSS SECTIONS</b> <b>LEVELS ROAD</b></p>	SHEET NO.	
						T200811301			DESIGNED BY: PB	257
						COUNTY			CHECKED BY: RK	TOTAL SHTS.
						NEW CASTLE				539

# DRAFT

# NOT FOR BIDDING

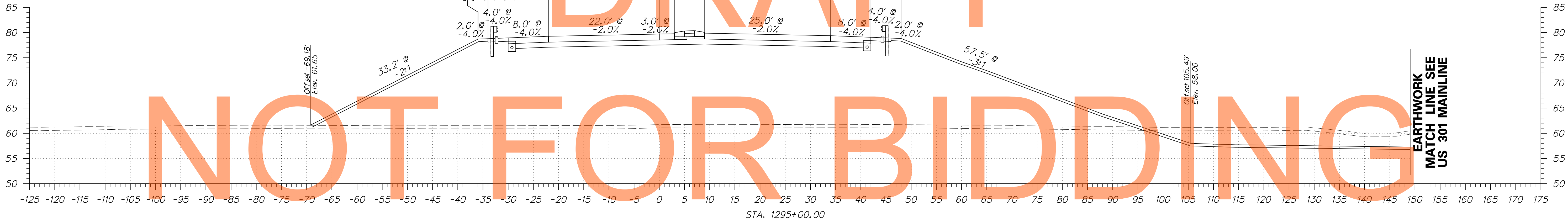

# AUGUST 2015

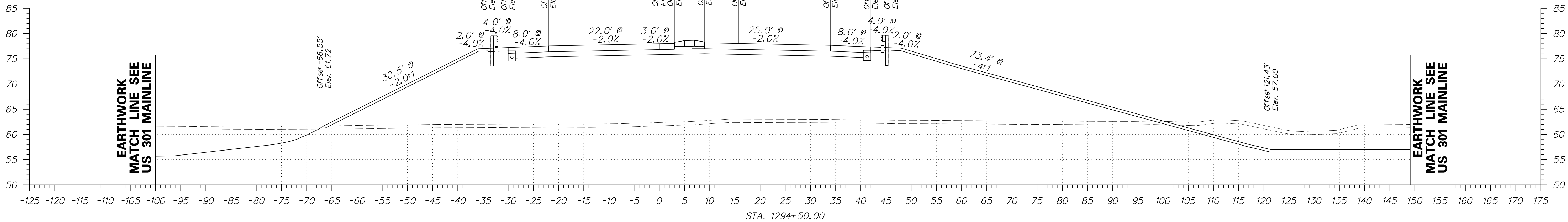

ADDENDUMS / REVISIONS	

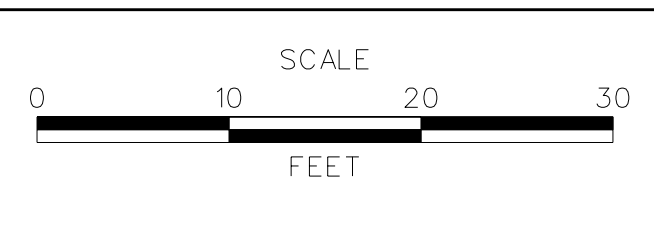

CONTRACT T200811301	BRIDGE NO.
COUNTY NEW CASTLE	DESIGNED BY: PB
	CHECKED BY: RK

DRAFT

NOT FOR BIDDING

AUGUST 2015

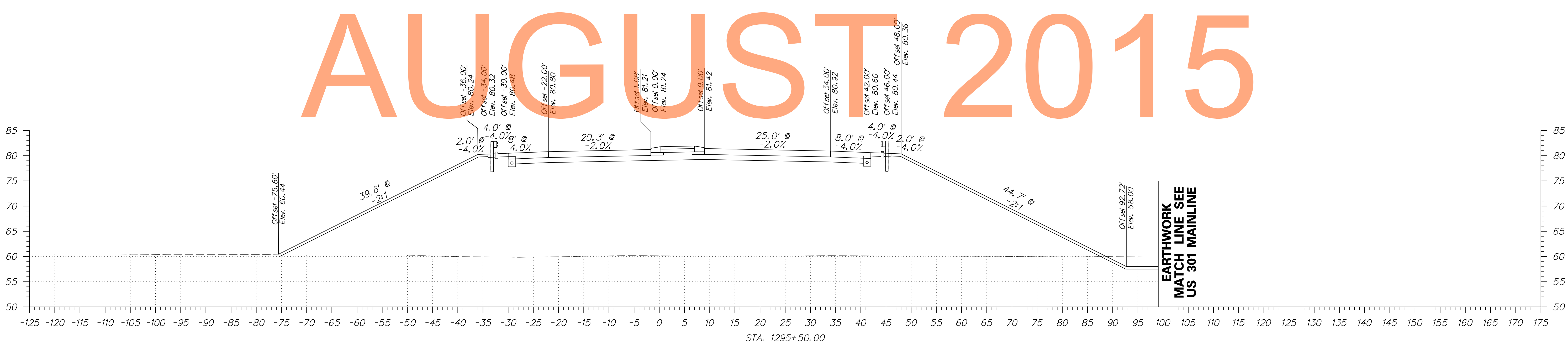
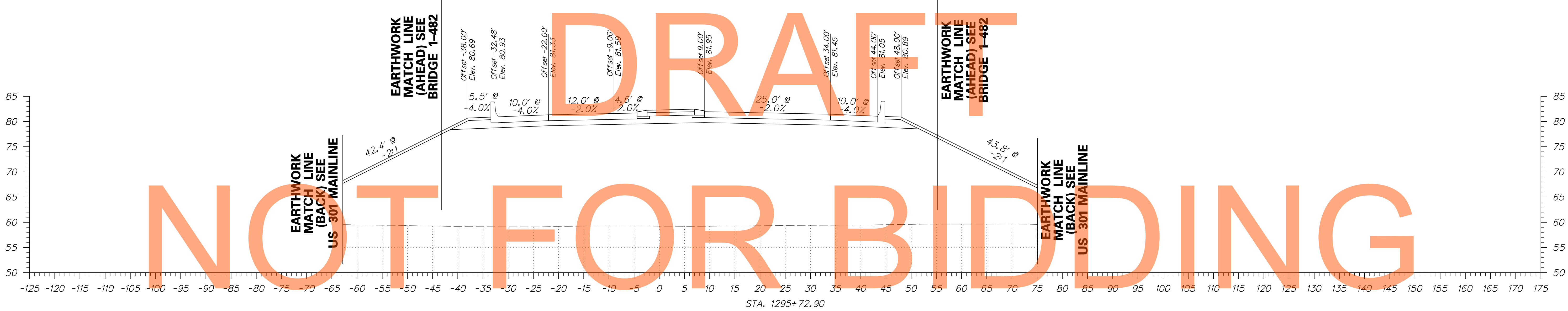

DRAFT

NOT FOR BIDDING

AUGUST 2015

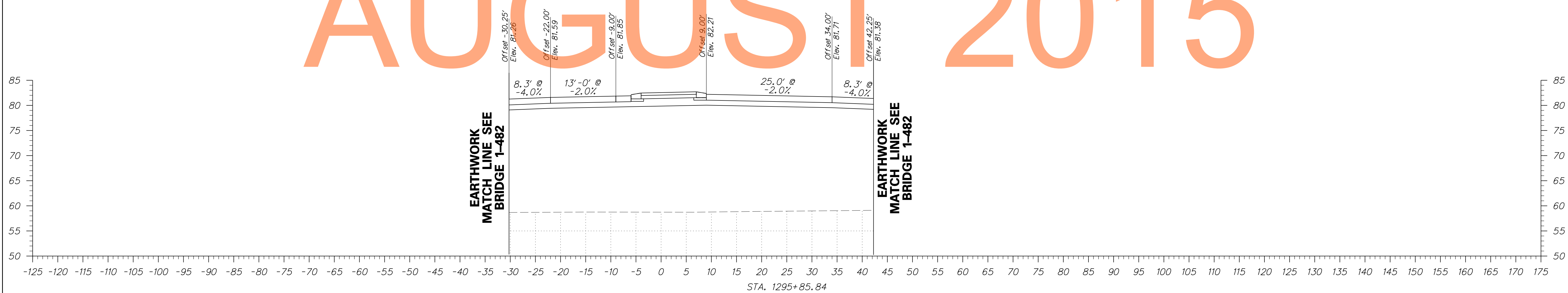
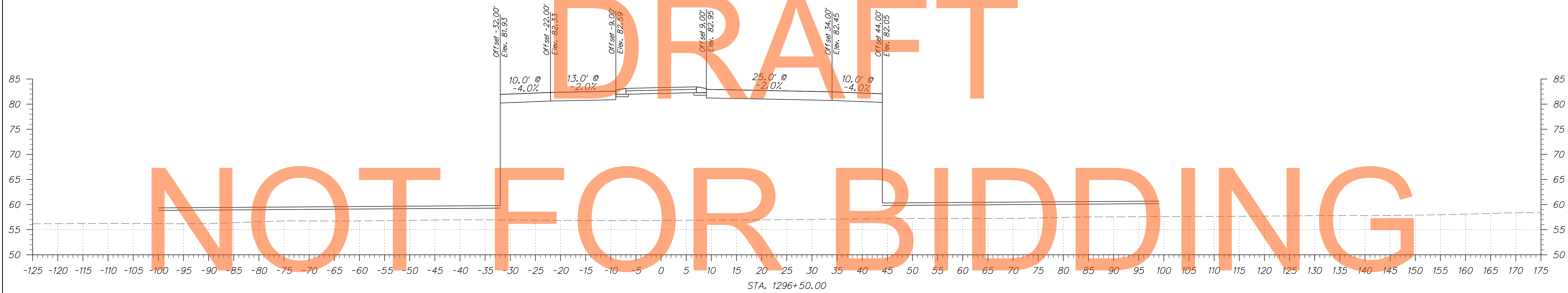

DRAFT

NOT FOR BIDDING

AUGUST 2015

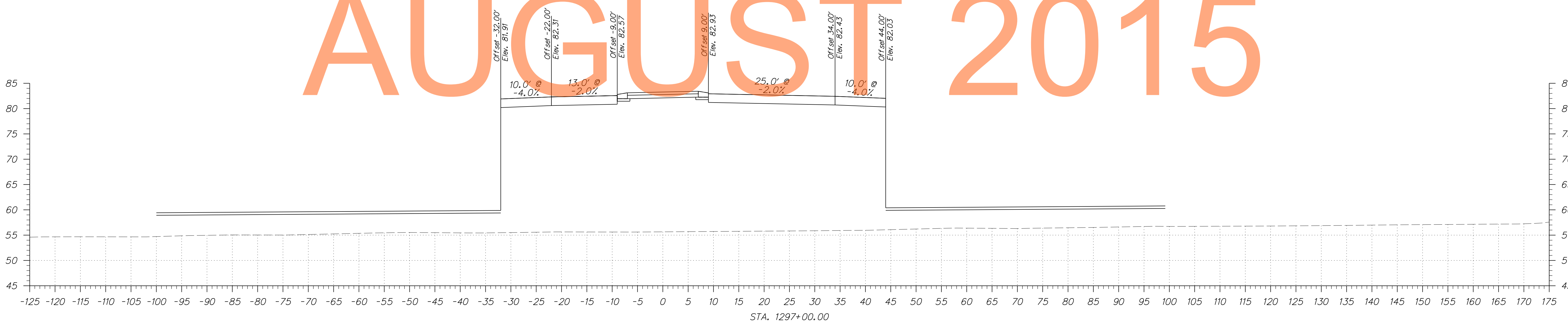
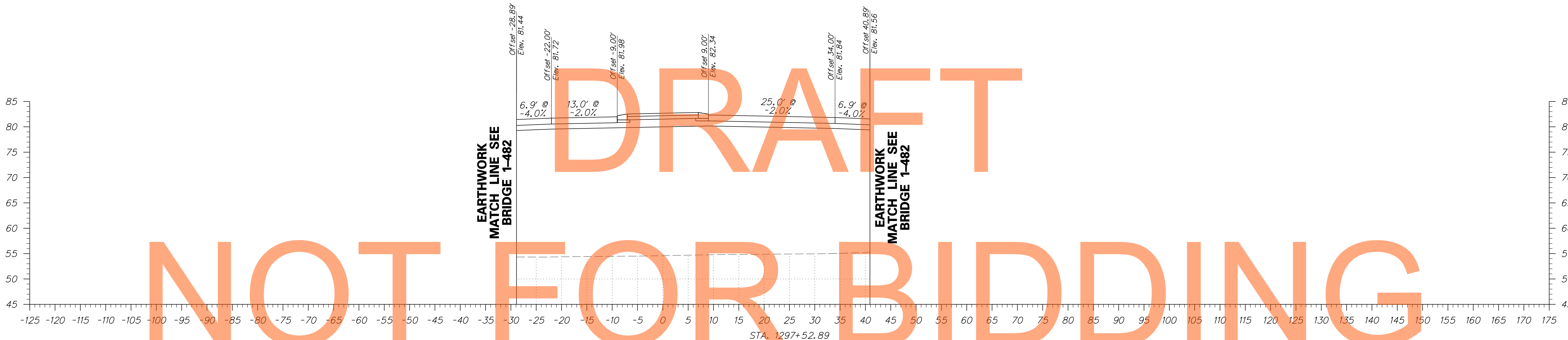

ADDENDUMS / REVISIONS	

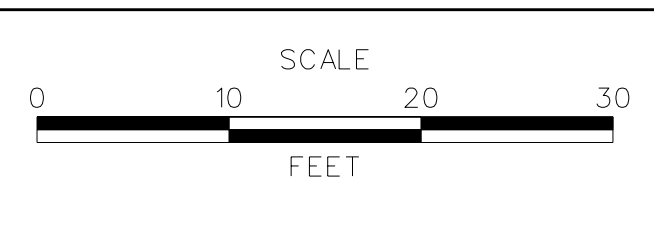

CONTRACT	BRIDGE NO.
T200811301	
COUNTY	DESIGNED BY: PB
NEW CASTLE	CHECKED BY: RK

DRAFT

NOT FOR BIDDING

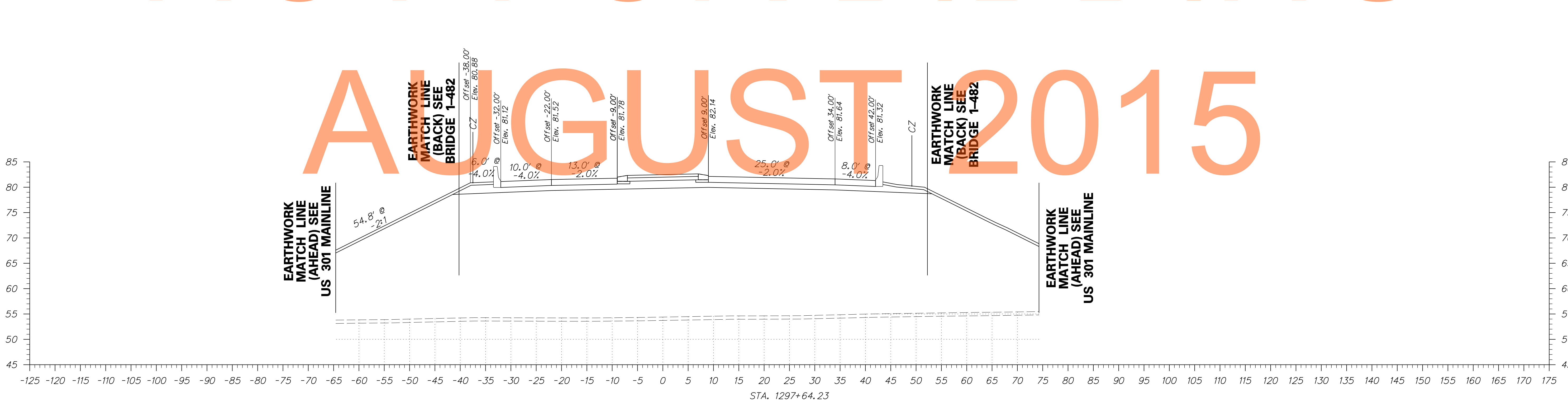
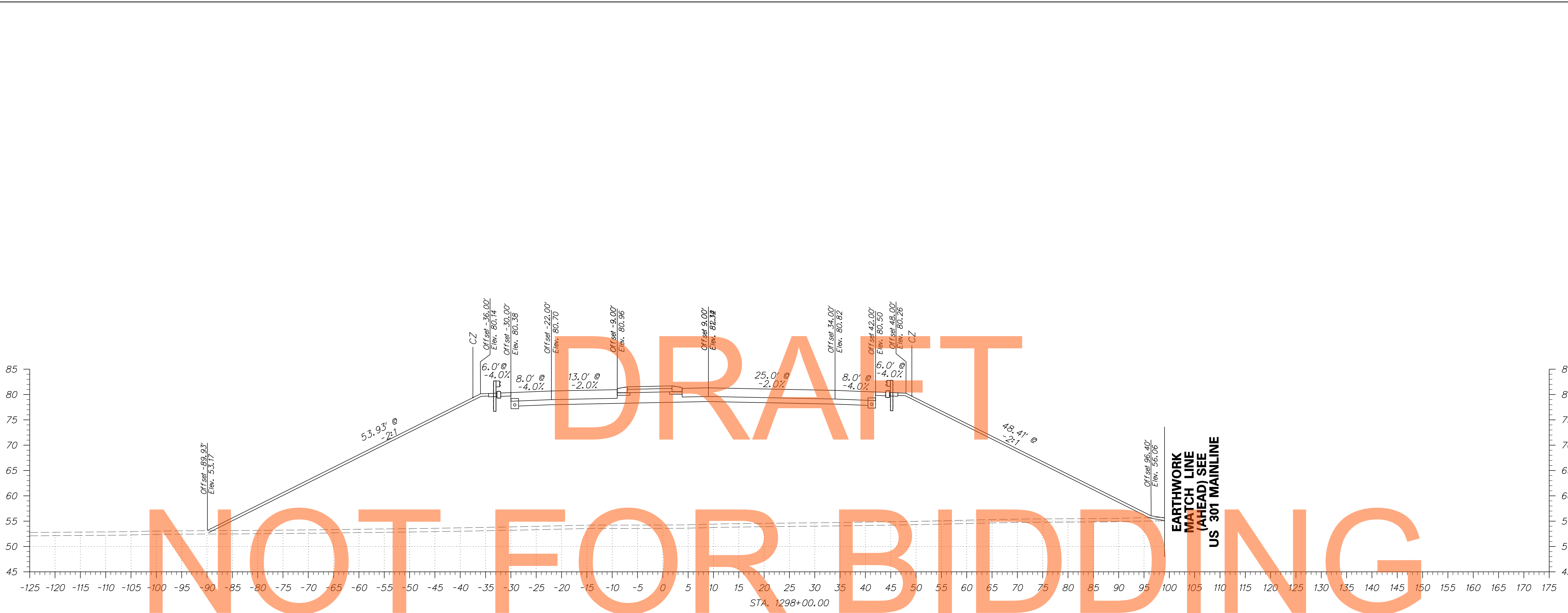

ADDENDUMS / REVISIONS	

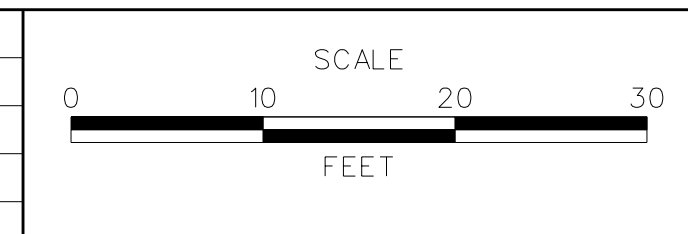

**US 301  
MARYLAND STATE LINE  
TO LEVELS ROAD**

CONTRACT T200811301	BRIDGE NO.
COUNTY NEW CASTLE	DESIGNED BY: PB
	CHECKED BY: RK

<b>CROSS SECTIONS LEVELS ROAD</b>	SHEET NO. 262
	TOTAL SHTS. 539

# DRAFT

# NOT FOR BIDDING

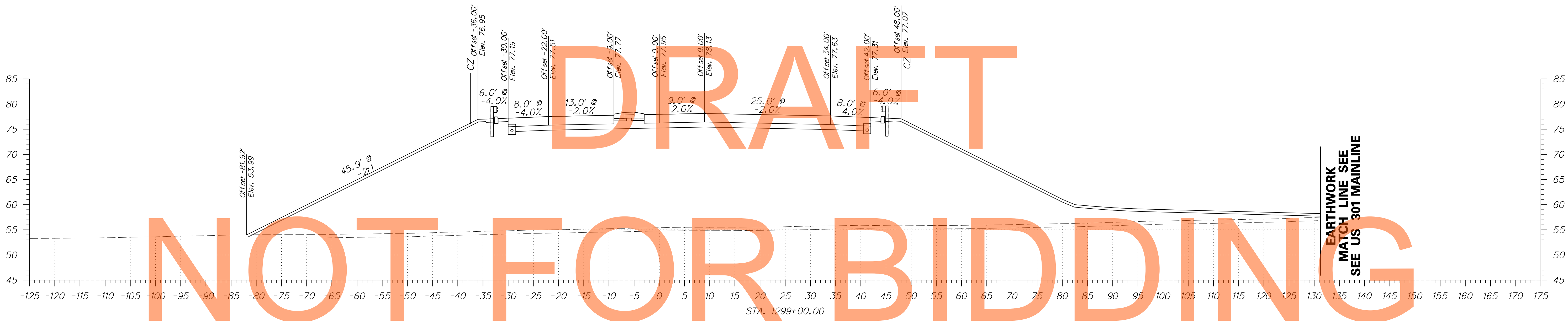

# AUGUST 2015

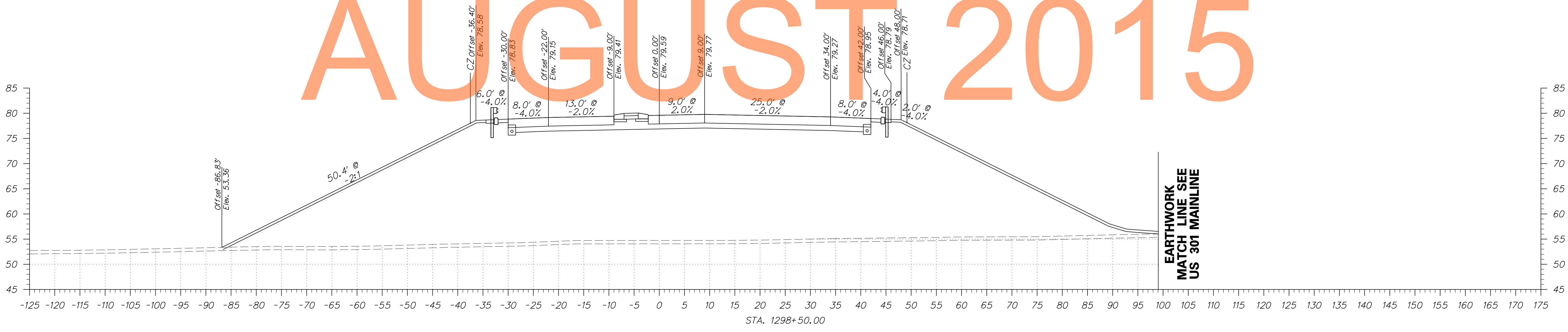

ADDENDUMS / REVISIONS	

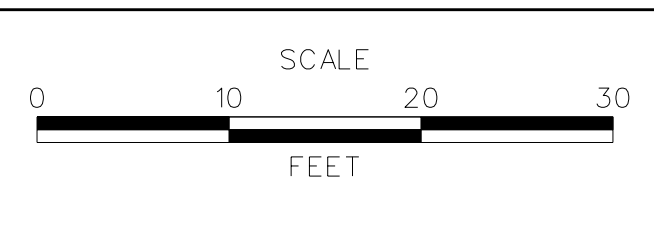

**US 301  
MARYLAND STATE LINE  
TO LEVELS ROAD**

CONTRACT T200811301	BRIDGE NO.
COUNTY NEW CASTLE	DESIGNED BY: PB
	CHECKED BY: RK

<b>CROSS SECTIONS LEVELS ROAD</b>	SHEET NO. 263
	TOTAL SHTS. 539

DRAFT

NOT FOR BIDDING

AUGUST 2015

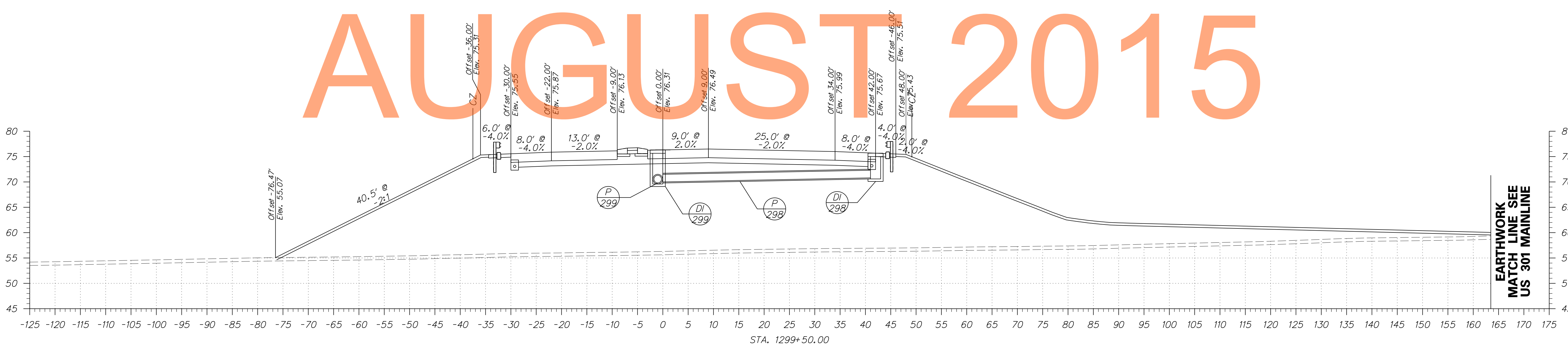
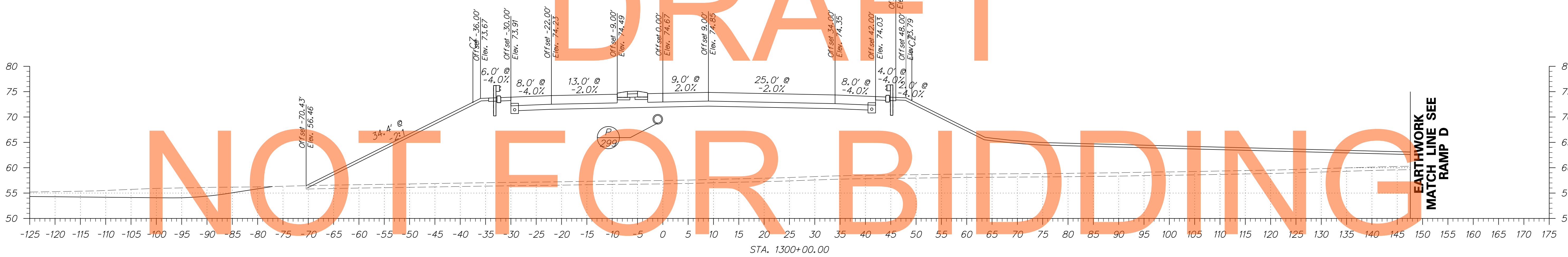

ADDENDUMS / REVISIONS	

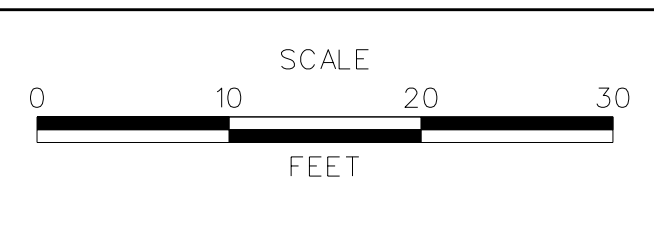

**US 301**  
**MARYLAND STATE LINE**  
**TO LEVELS ROAD**

CONTRACT T200811301	BRIDGE NO. 
COUNTY NEW CASTLE	DESIGNED BY: 
	CHECKED BY: 

**CROSS SECTIONS**  
**LEVELS ROAD**

SHEET NO. 264
TOTAL SHTS. 539



EARTHWORK  
MATCH LINE  
(AHEAD)  
SEE RAMP C

EARTHWORK  
MATCH LINE  
(BACK)  
SEE RAMP C

EARTHWORK  
MATCH LINE  
(BACK)  
SEE RAMP D

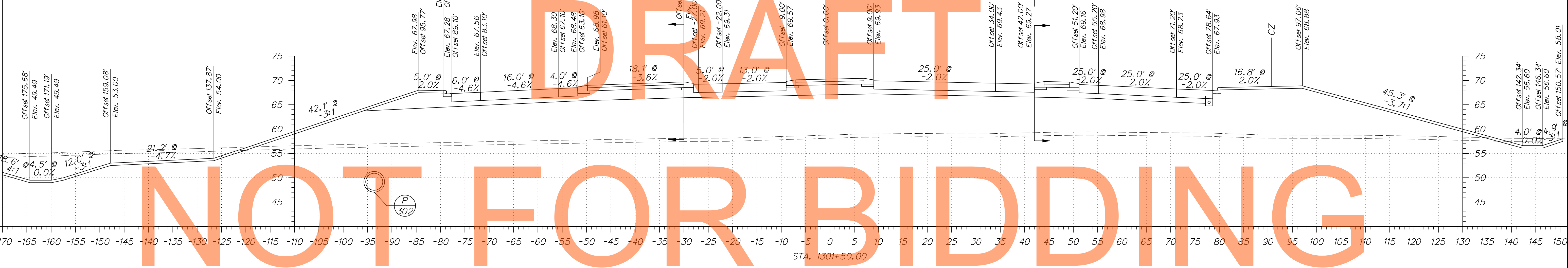

NOT FOR BIDDING

AUGUST 2015

EARTHWORK  
MATCH LINE  
(AHEAD)  
SEE RAMP C

EARTHWORK  
MATCH LINE  
(AHEAD)  
SEE RAMP D

EARTHWORK  
MATCH LINE  
(BACK)  
SEE RAMP D

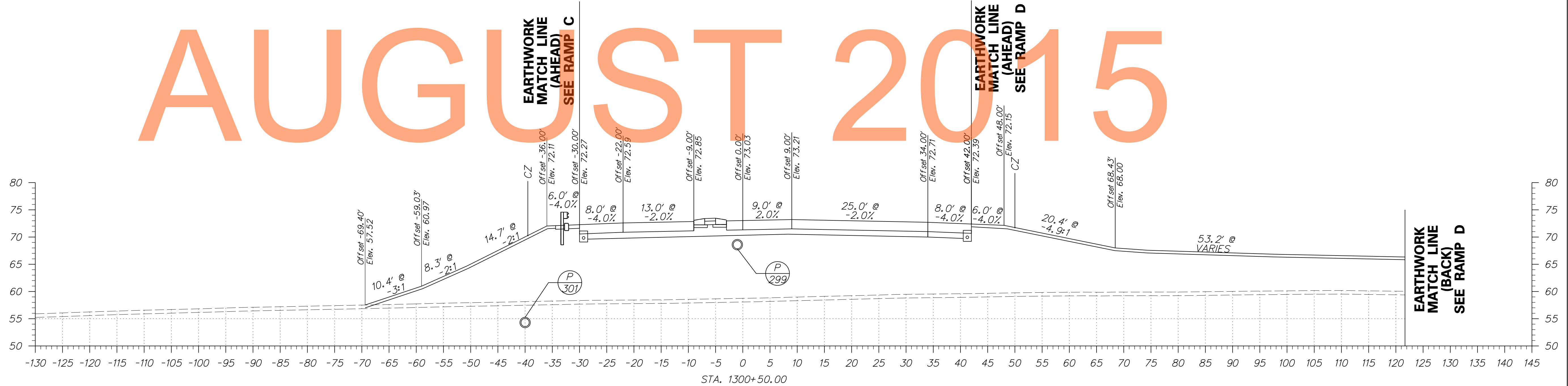

DRAFT

NOT FOR BIDDING

AUGUST 2015

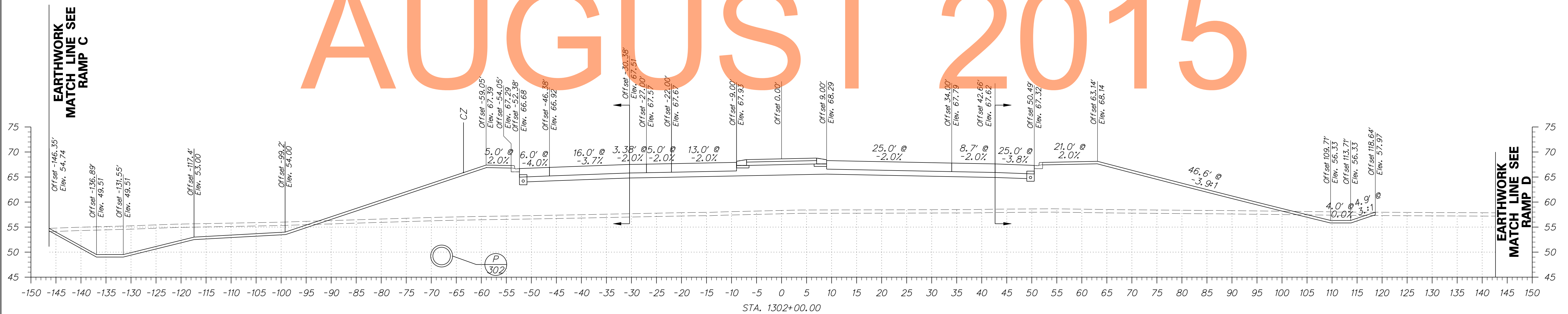
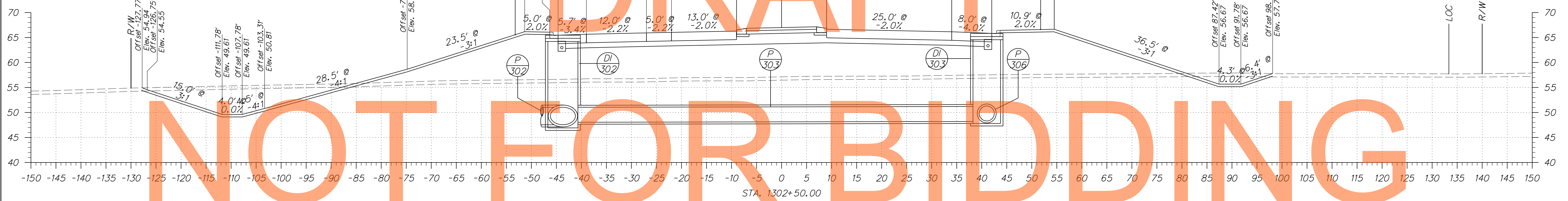

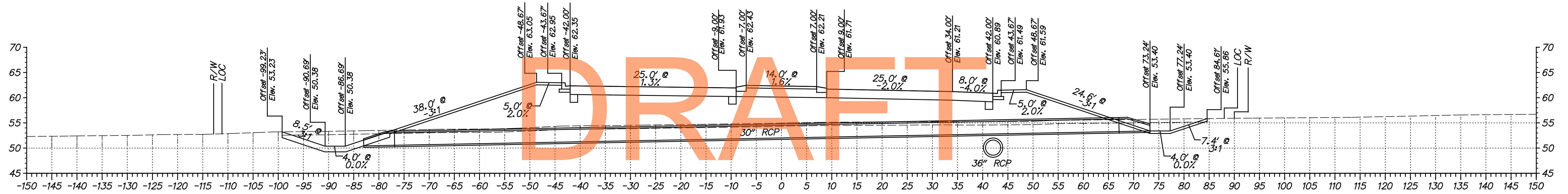

STATION 1304+00

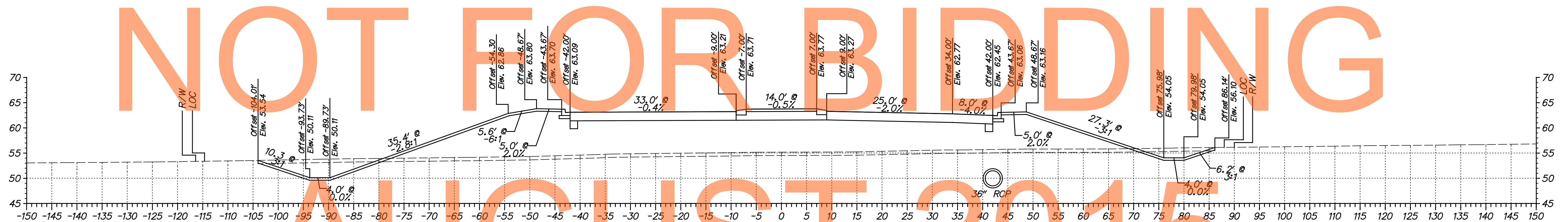

STATION 1303+50

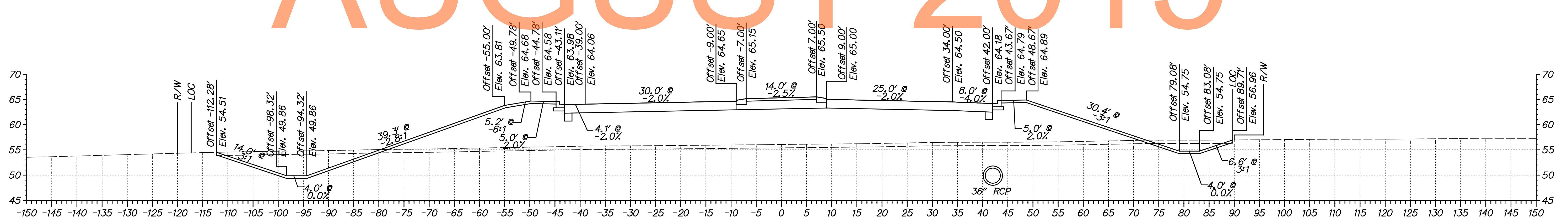

STATION 1303+00

ADDENDUMS / REVISIONS	

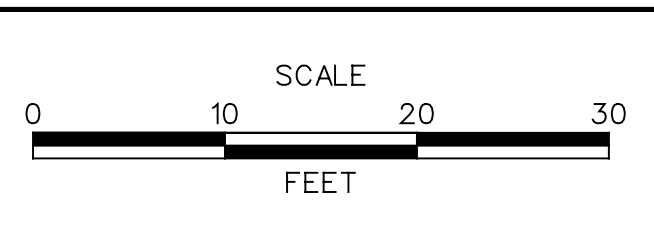

CONTRACT T200811301	BRIDGE NO.
COUNTY NEW CASTLE	DESIGNED BY: MAG/TAM
	CHECKED BY: PAH

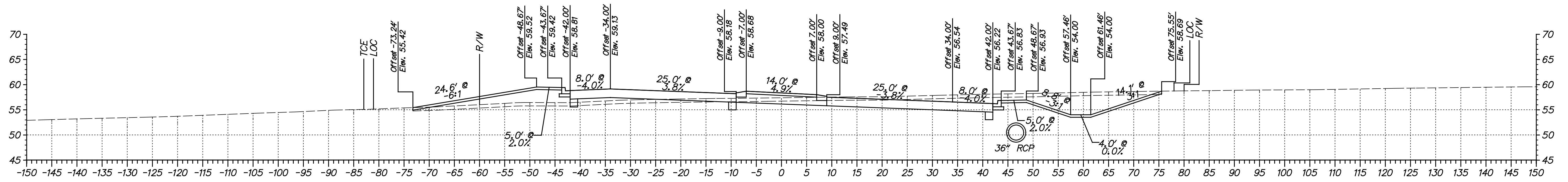

STATION 1306+00

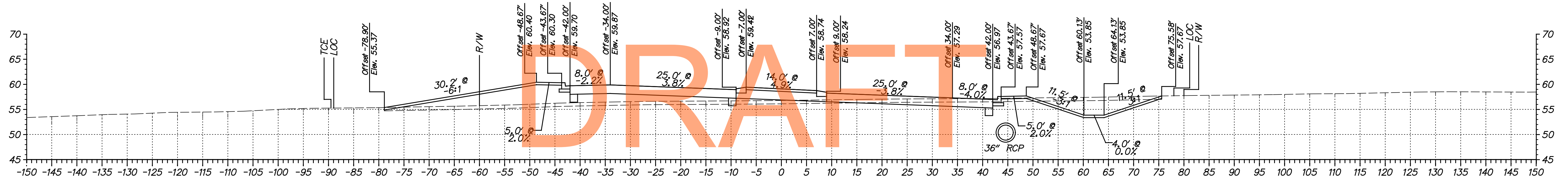

STATION 1305+50

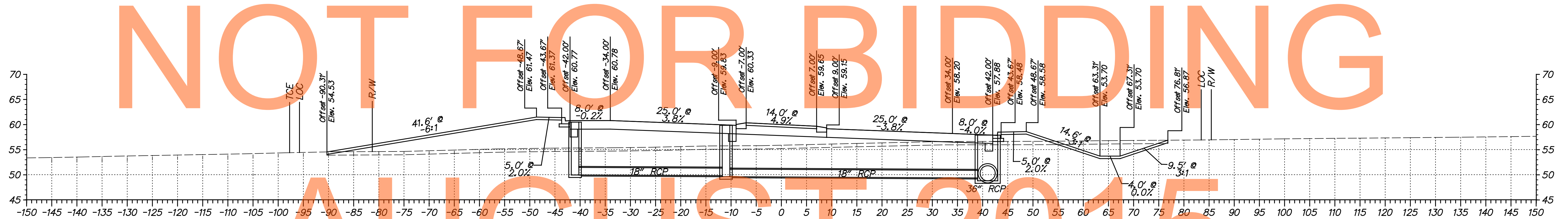

STATION 1305+00

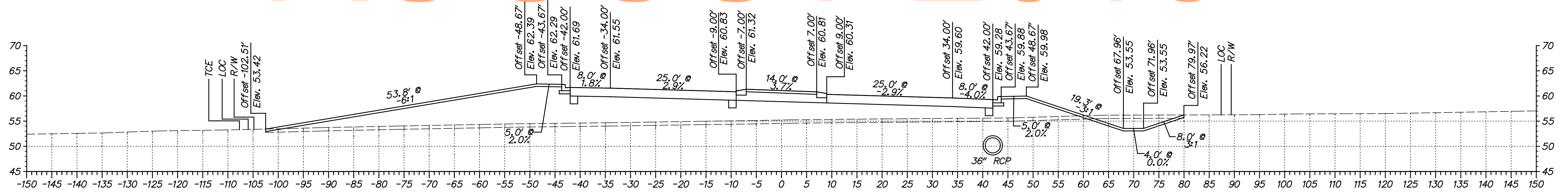

STATION 1304+50

NOT FOR BIDDING  
AUGUST 2015



ADDENDUMS / REVISIONS

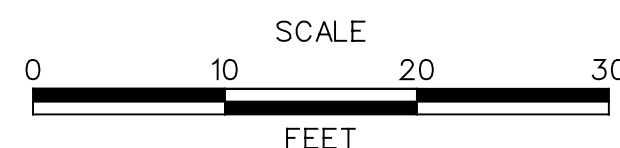

**US 301  
MARYLAND STATE LINE  
TO LEVELS ROAD**

CONTRACT T200811301	BRIDGE NO.
COUNTY NEW CASTLE	DESIGNED BY: MAG/TAM
	CHECKED BY: PAH

**CROSS SECTIONS  
LEVELS ROAD**

SHEET NO. 268
TOTAL SHTS. 539

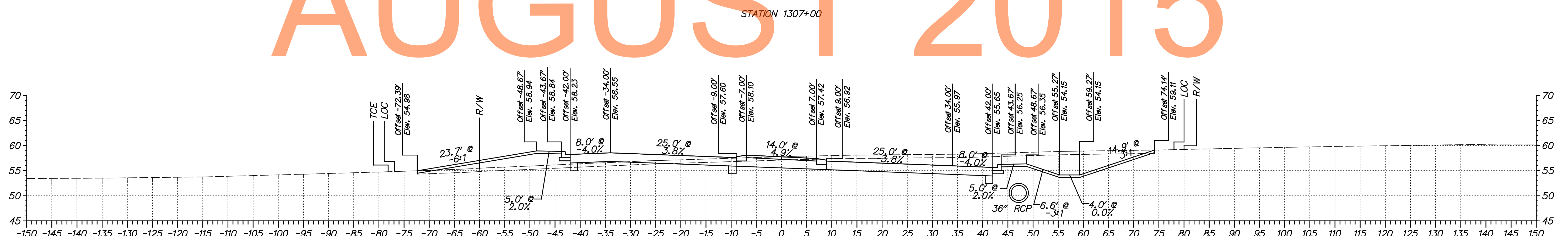
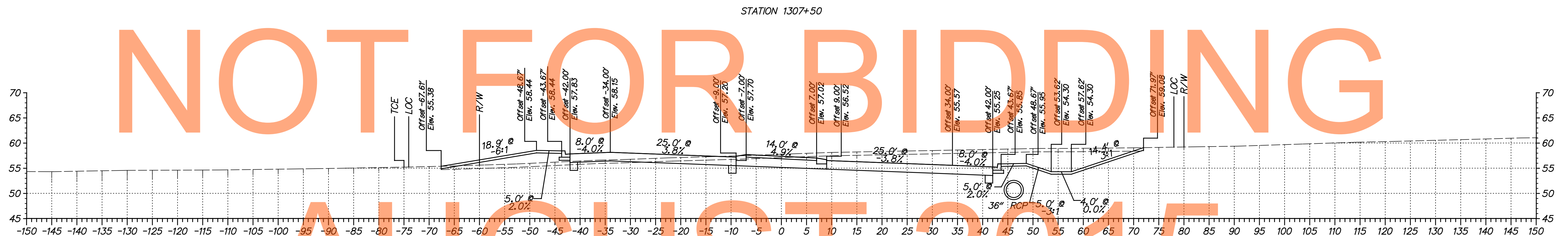
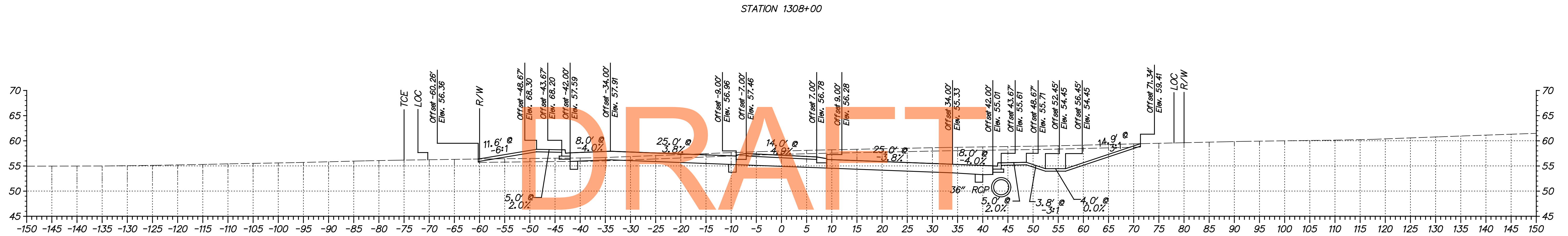
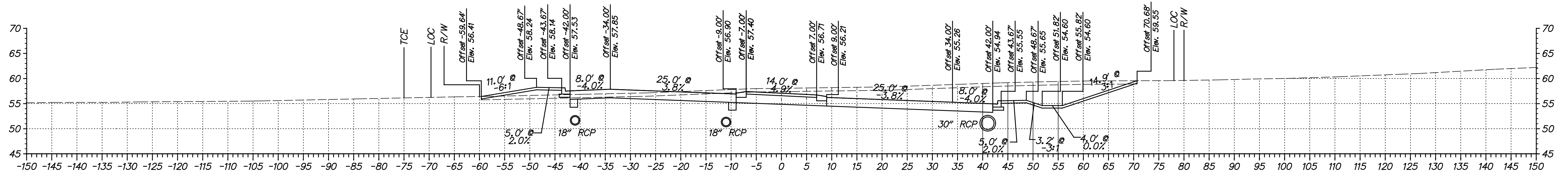

DRAFT

NOT FOR BIDDING

AUGUST 2015

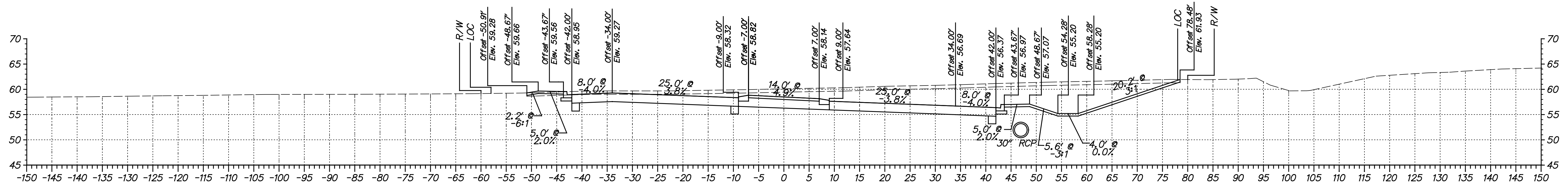

STATION 1310+00

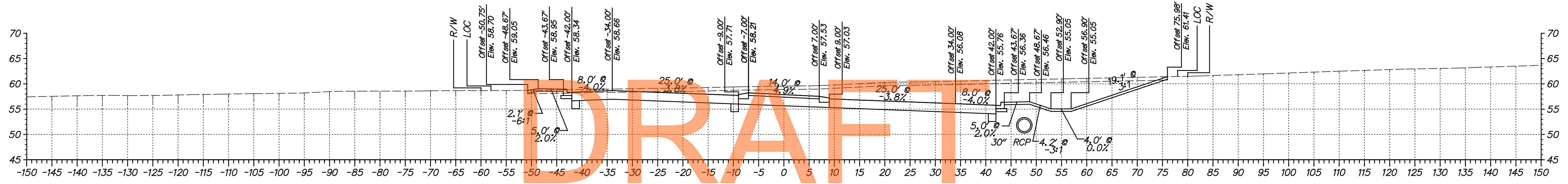

STATION 1309+50

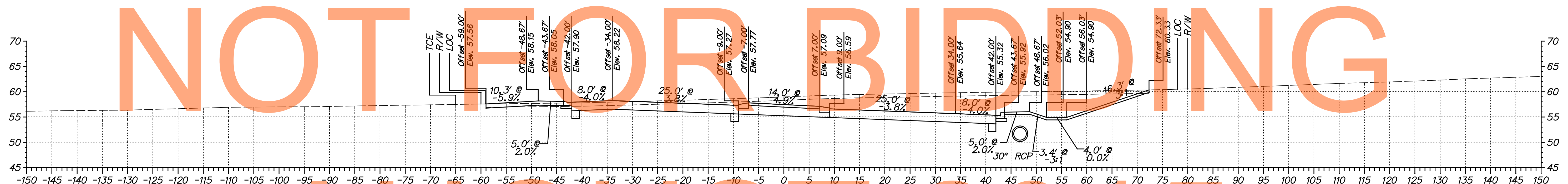

STATION 1309+00

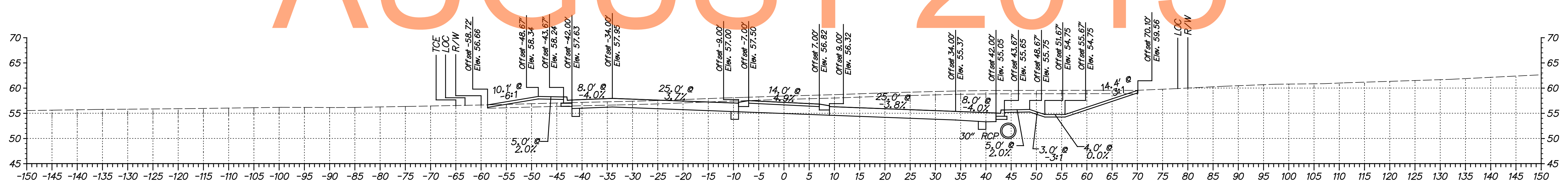

STATION 1308+50

NOT FOR BIDDING  
AUGUST 2015

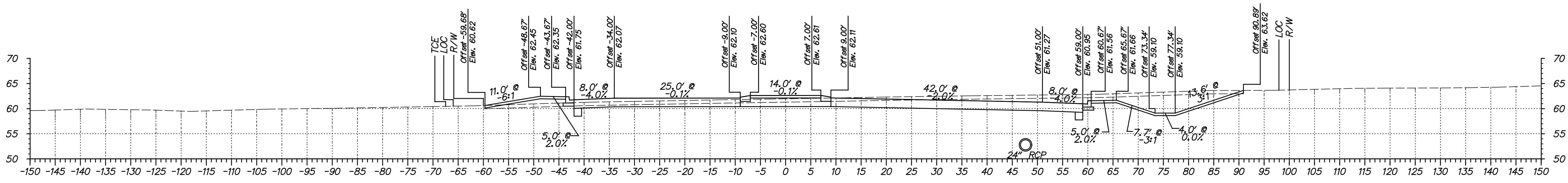

STATION 1312+00

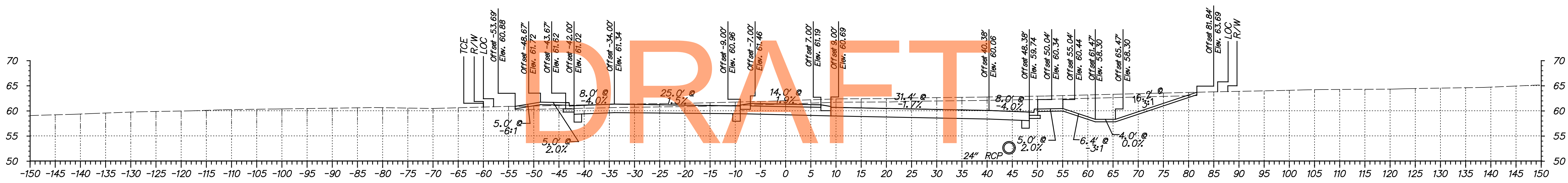

STATION 1311+50

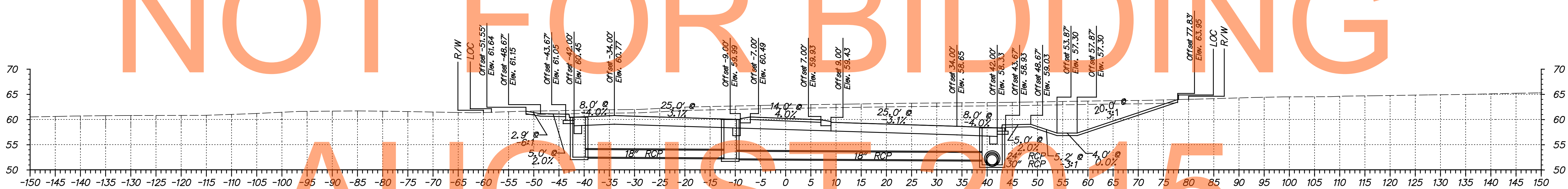

STATION 1311+00

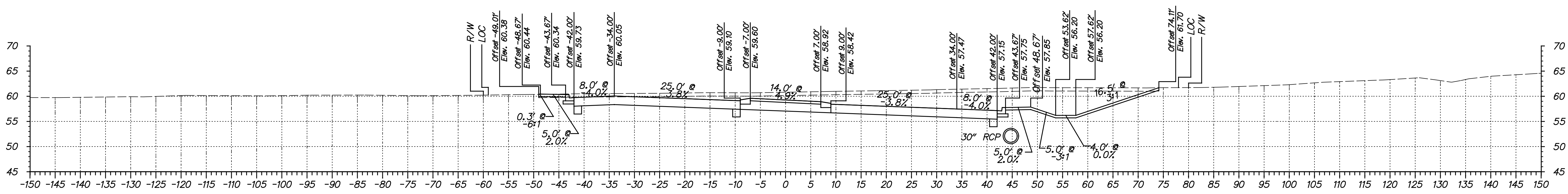

STATION 1310+50

DRAFT

NOT FOR BIDDING

AUGUST 2015

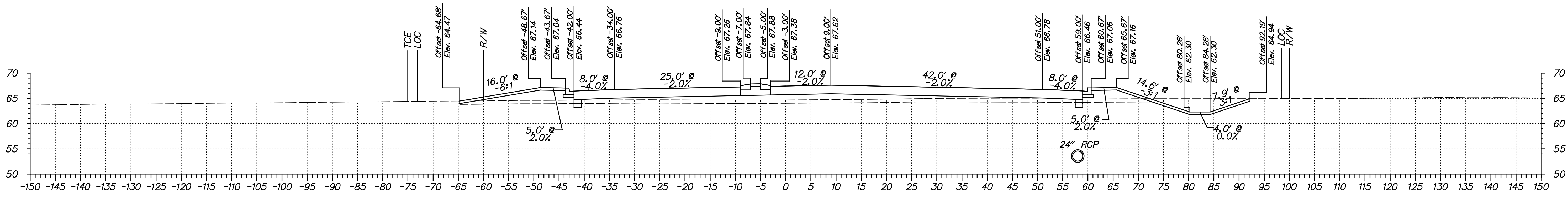

STATION 1314+00

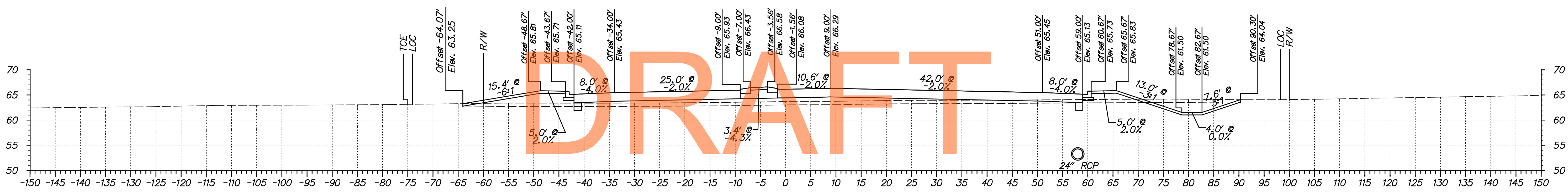

STATION 1313+50

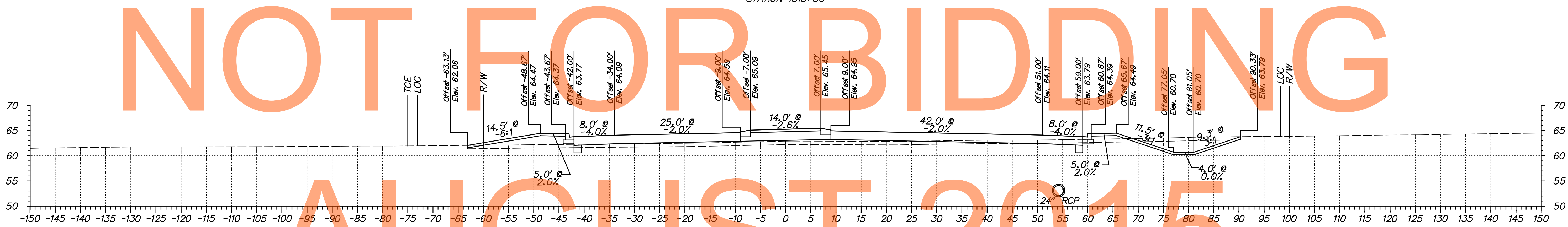

STATION 1313+00

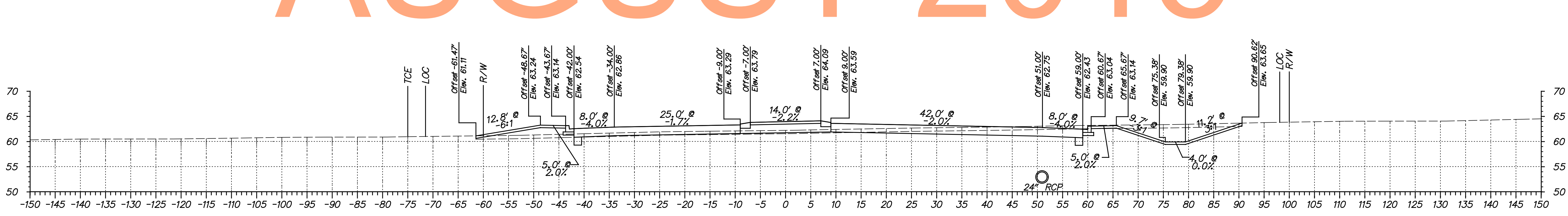

STATION 1312+50

DRAFT

NOT FOR BIDDING

AUGUST 2015

ADDENDUMS / REVISIONS	

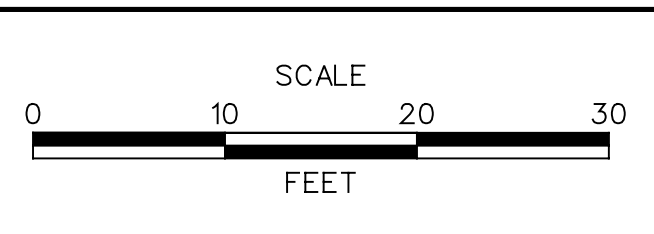

CONTRACT T200811301	BRIDGE NO.
COUNTY NEW CASTLE	DESIGNED BY: MAG/TAM
	CHECKED BY: PAH



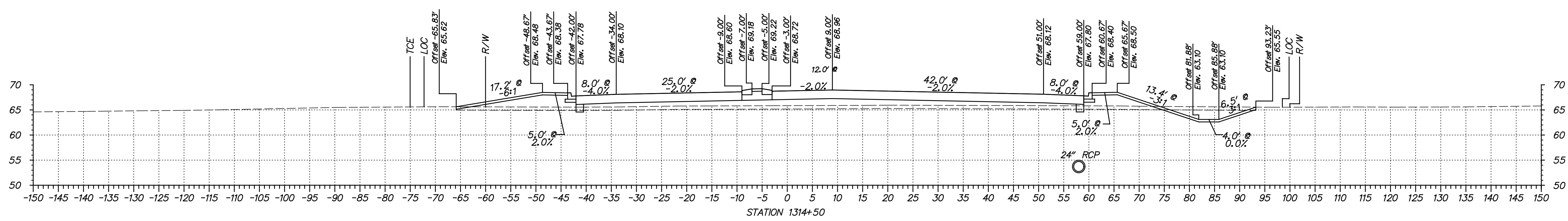
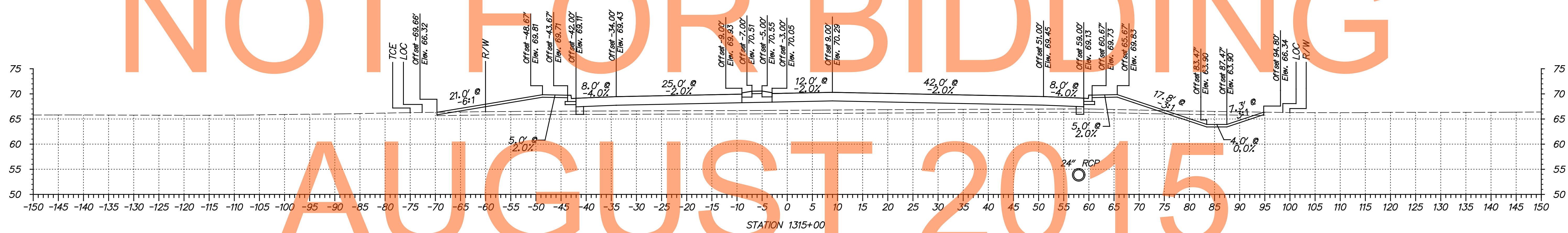
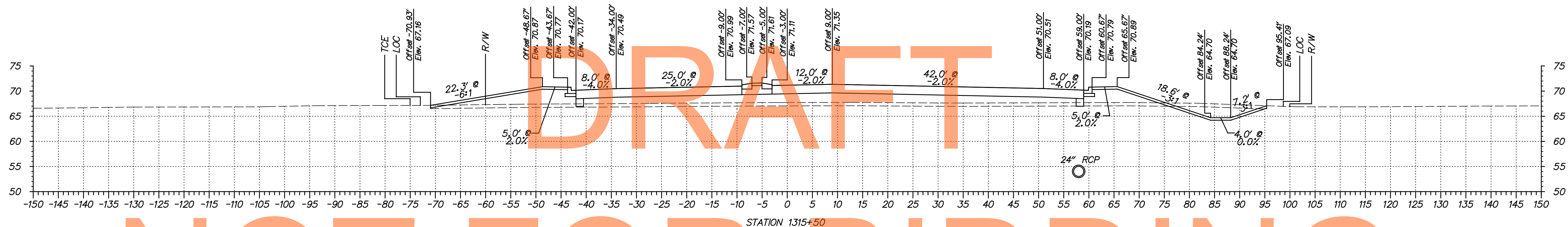
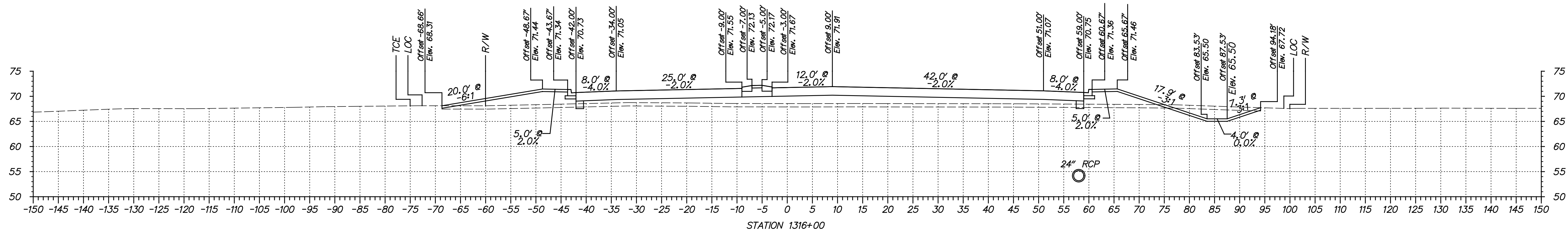

NOT FOR BIDDING  
AUGUST 2015

ADDENDUMS / REVISIONS	

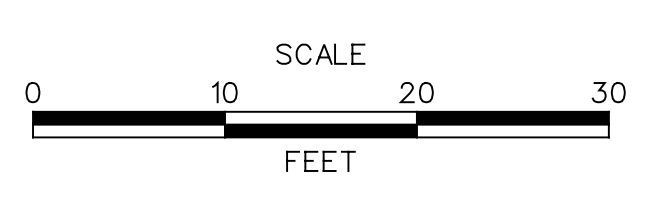

CONTRACT T200811301	BRIDGE NO.
COUNTY NEW CASTLE	DESIGNED BY: MAG/TAM
	CHECKED BY: PAH

<b>CROSS SECTIONS</b> <b>LEVELS ROAD</b>	SHEET NO. 273
	TOTAL SHTS. 539

# DRAFT

# NOT FOR BIDDING

# AUGUST 2015

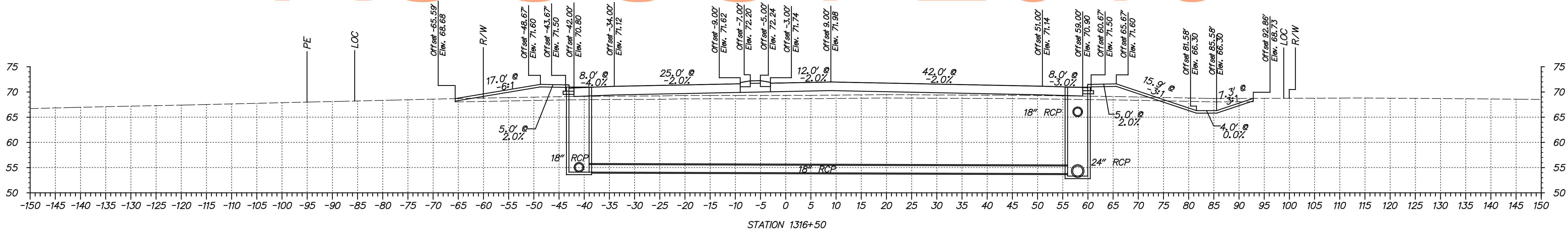
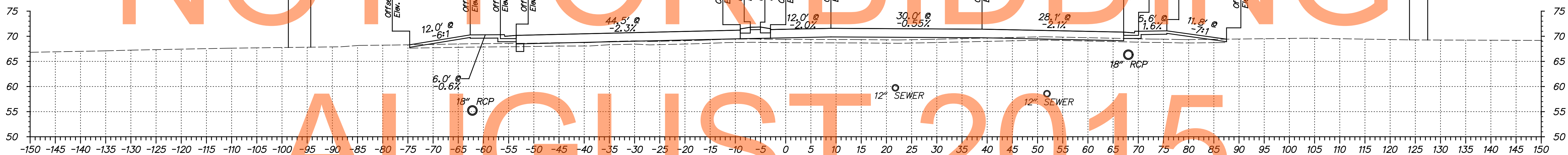

ADDENDUMS / REVISIONS	

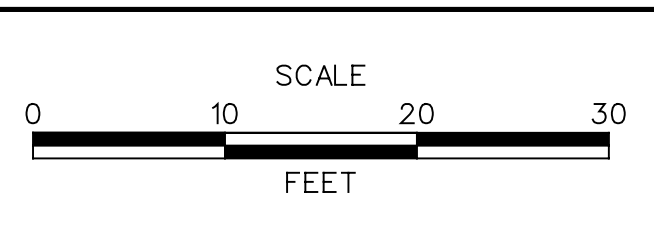

CONTRACT T200811301	BRIDGE NO.
COUNTY NEW CASTLE	DESIGNED BY: MAG/TAM
	CHECKED BY: PAH

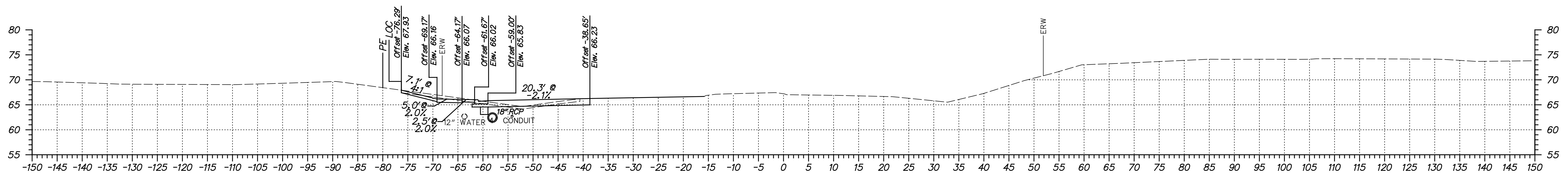

STATION 662+00

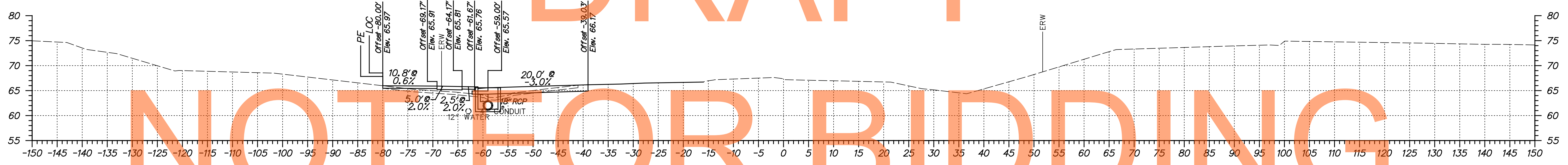

STATION 661+50

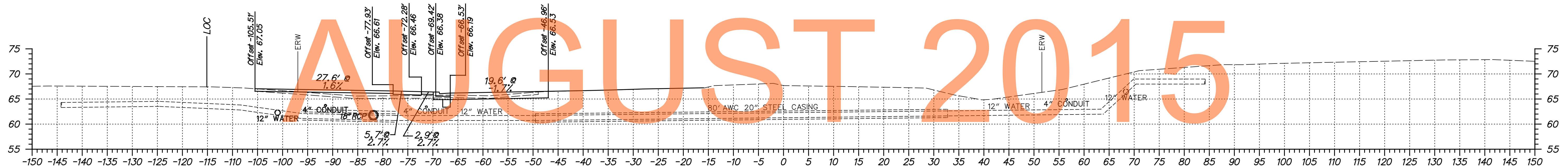

STATION 661+00

DRAFT  
NOT FOR BIDDING  
AUGUST 2015



ADDENDUMS / REVISIONS	

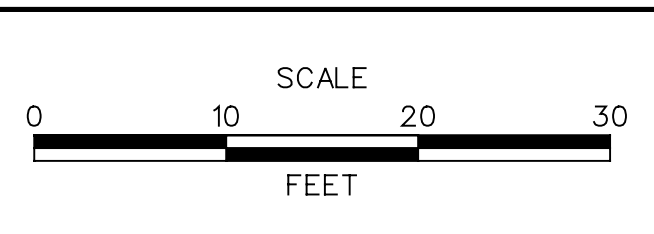

**US 301  
MARYLAND STATE LINE  
TO LEVELS ROAD**

CONTRACT T200811301	BRIDGE NO.
COUNTY NEW CASTLE	DESIGNED BY: MAG/TAM
	CHECKED BY: PAH

**CROSS SECTIONS  
EXISTING LEVELS ROAD**

SHEET NO. 275
TOTAL SHTS. 539

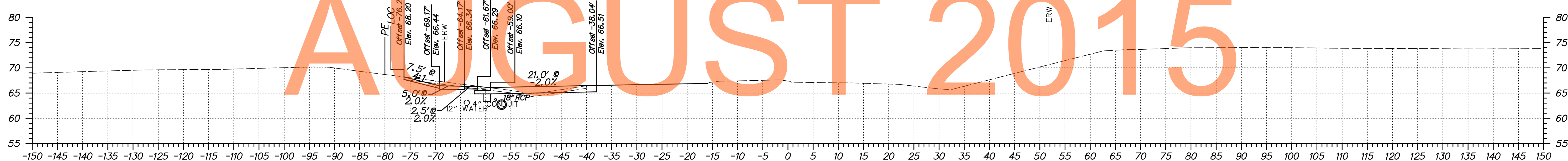
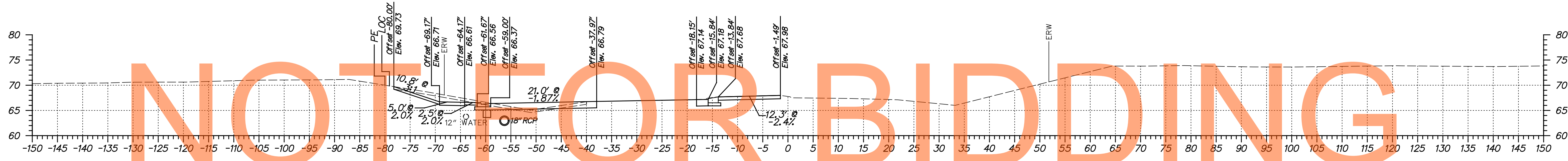
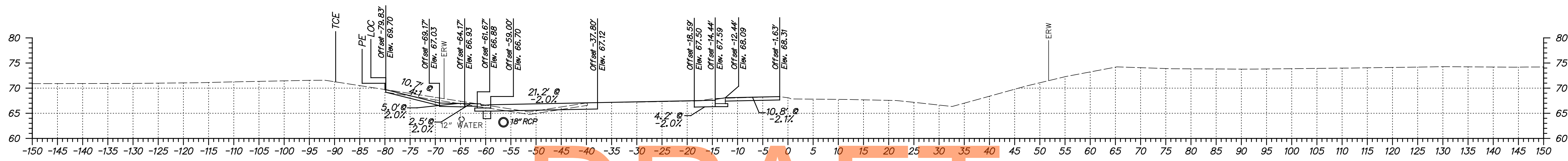

DRAFT  
NOT FOR BIDDING  
AUGUST 2015

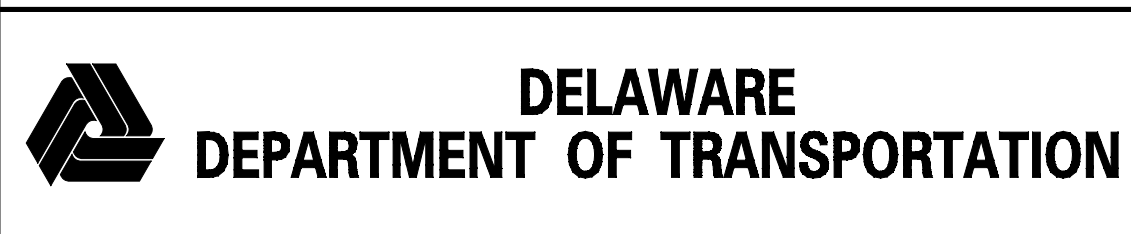

ADDENDUMS / REVISIONS

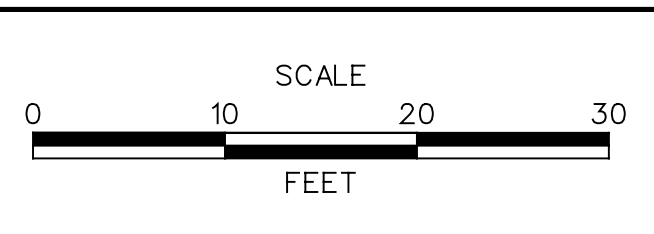

**US 301**  
**MARYLAND STATE LINE**  
**TO LEVELS ROAD**

CONTRACT T200811301	BRIDGE NO. 	DESIGNED BY: MAG/TAM
COUNTY NEW CASTLE		CHECKED BY: PAH

**CROSS SECTIONS**  
**EXISTING LEVELS ROAD**

SHEET NO. 276	TOTAL SHTS. 539
------------------	--------------------

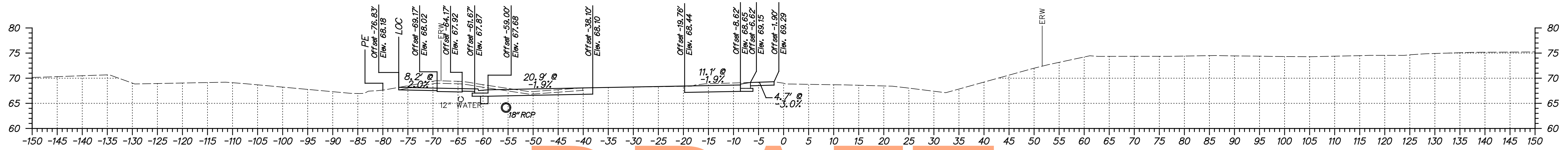

STATION 665+00

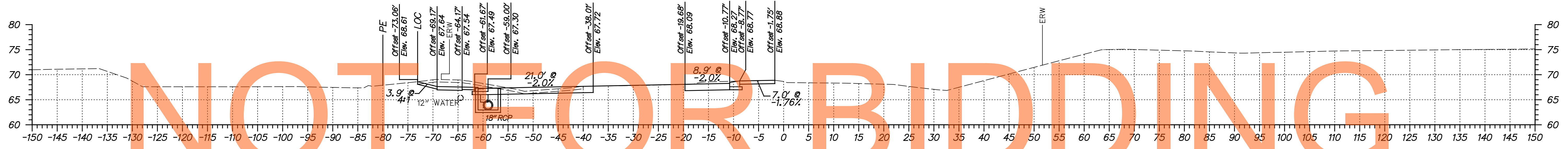

STATION 664+50

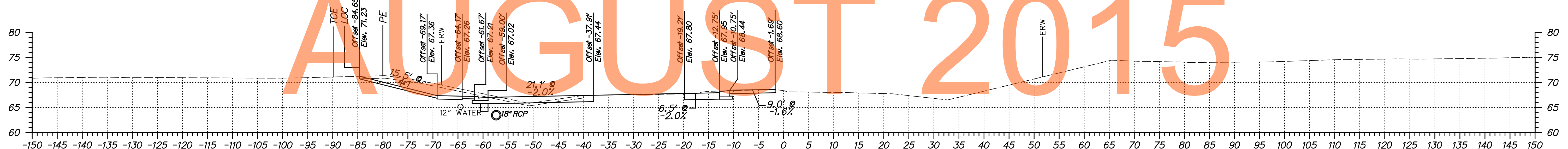

STATION 664+00



ADDENDUMS / REVISIONS

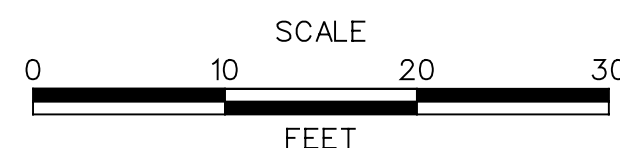

US 301  
MARYLAND STATE LINE  
TO LEVELS ROAD

CONTRACT	BRIDGE NO.
T200811301	
COUNTY	DESIGNED BY: MAG/TAM
NEW CASTLE	CHECKED BY: PAH

CROSS SECTIONS  
EXISTING LEVELS ROAD

SHEET NO.
277
TOTAL SHTS.
539

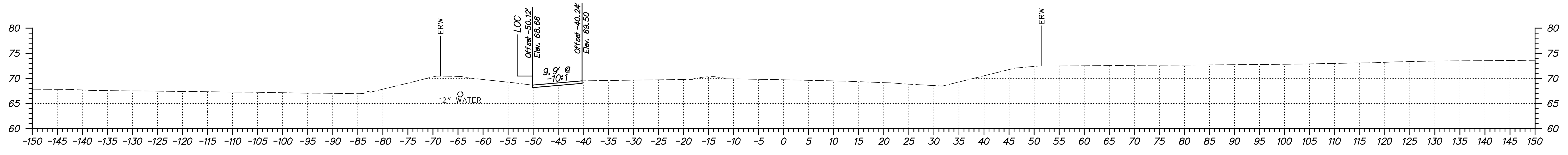

STATION 666+50

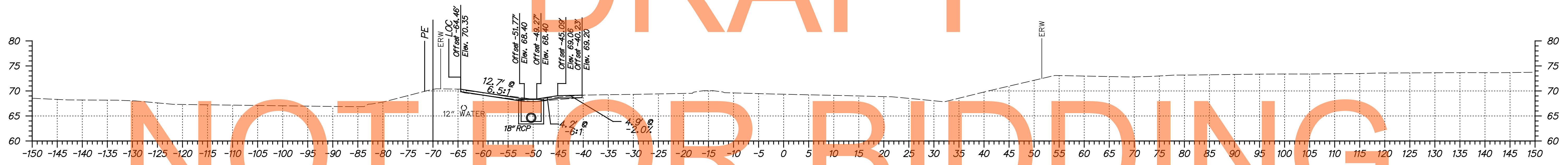

STATION 666+00

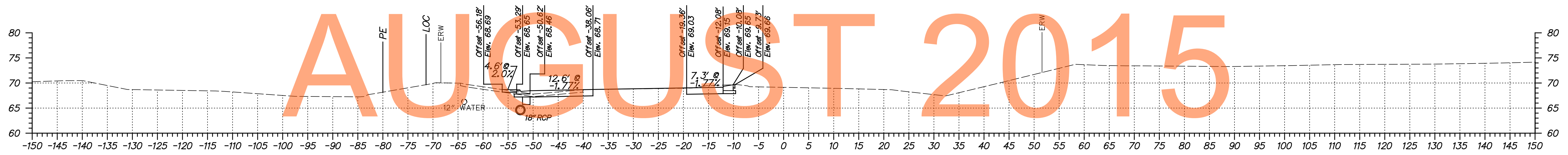

STATION 665+50

DRAFT  
NOT FOR BIDDING  
AUGUST 2015



ADDENDUMS / REVISIONS	

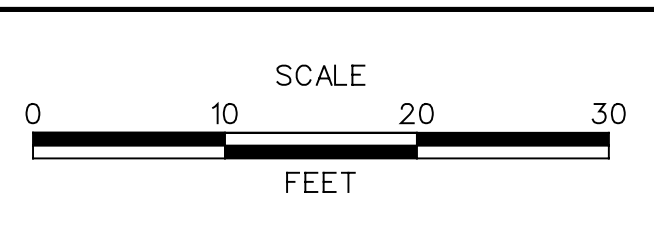

**US 301  
MARYLAND STATE LINE  
TO LEVELS ROAD**

CONTRACT T200811301	BRIDGE NO.
COUNTY NEW CASTLE	DESIGNED BY: MAG/TAM
	CHECKED BY: PAH

**CROSS SECTIONS  
EXISTING LEVELS ROAD**

SHEET NO. 278
TOTAL SHTS. 539

DRAFT

NOT FOR BIDDING

AUGUST 2015

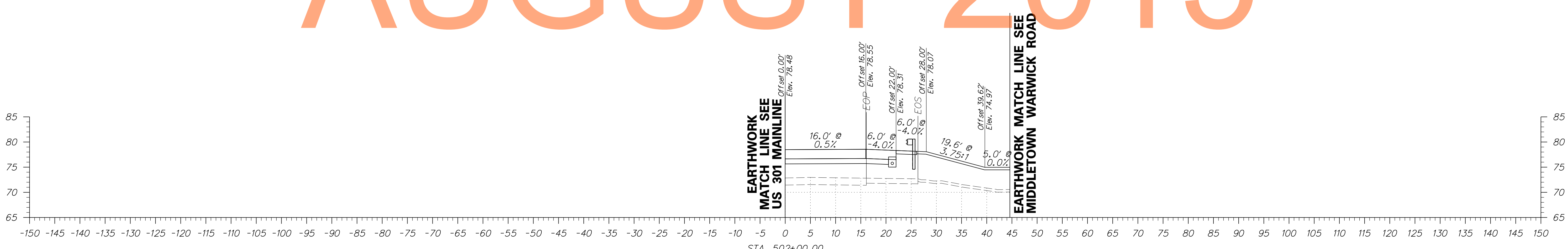
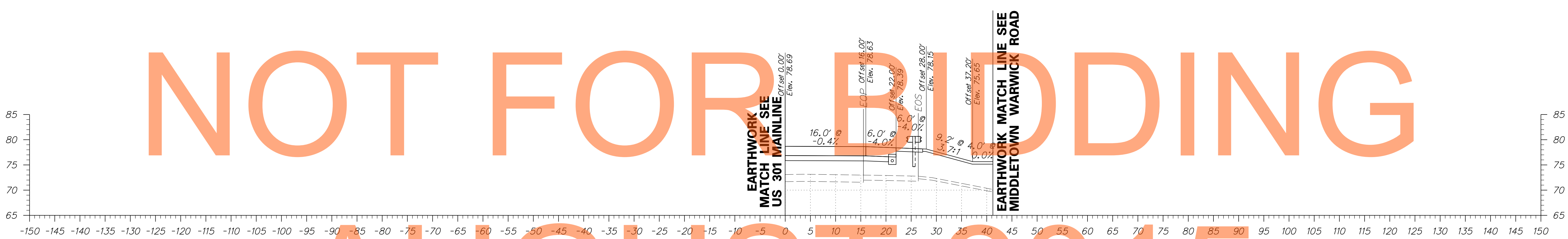
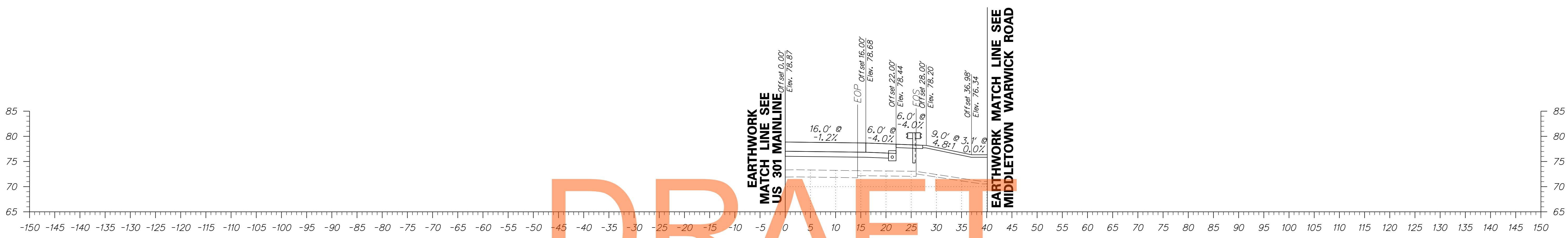

DRAFT

NOT FOR BIDDING

AUGUST 2015

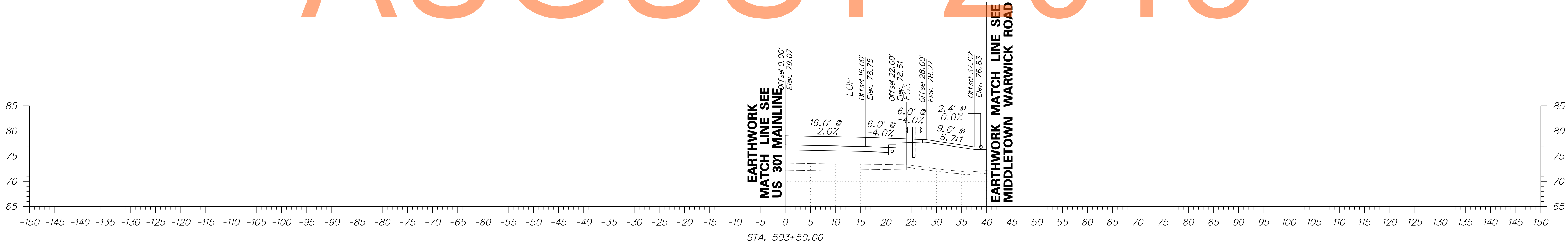
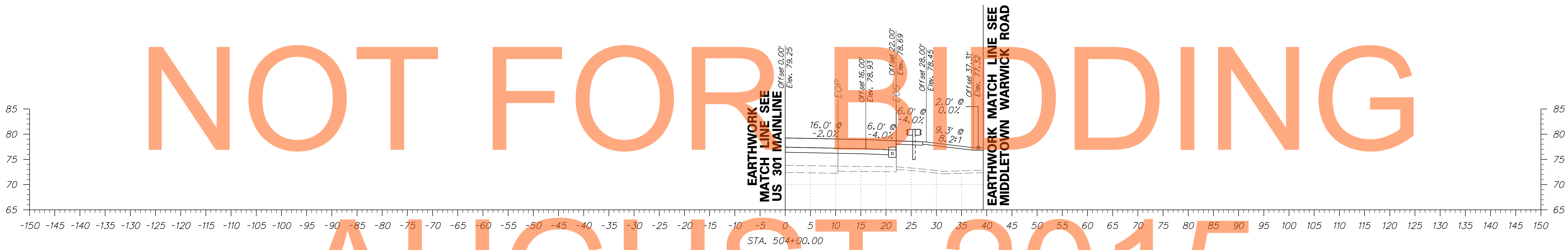
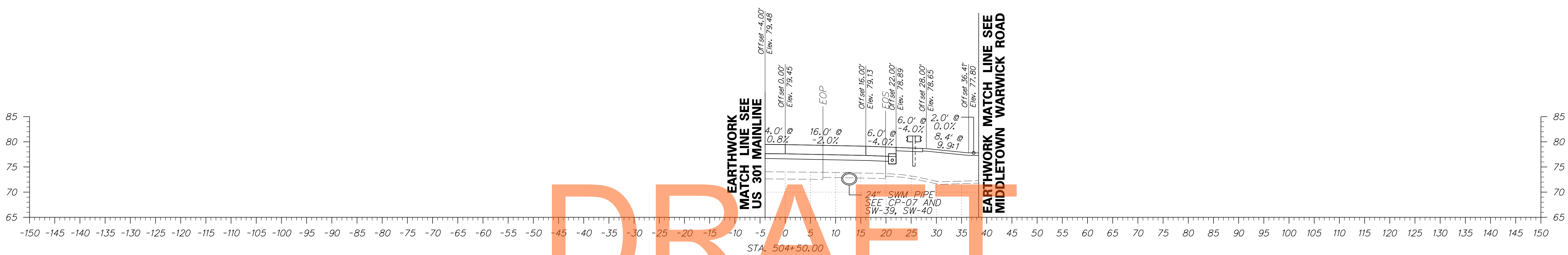



DRAFT

NOT FOR BIDDING

AUGUST 2015

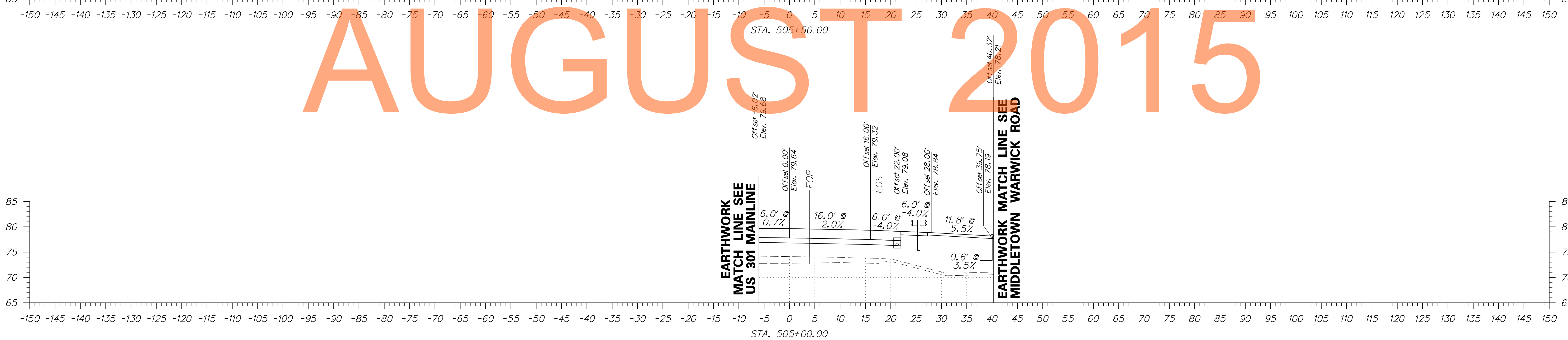
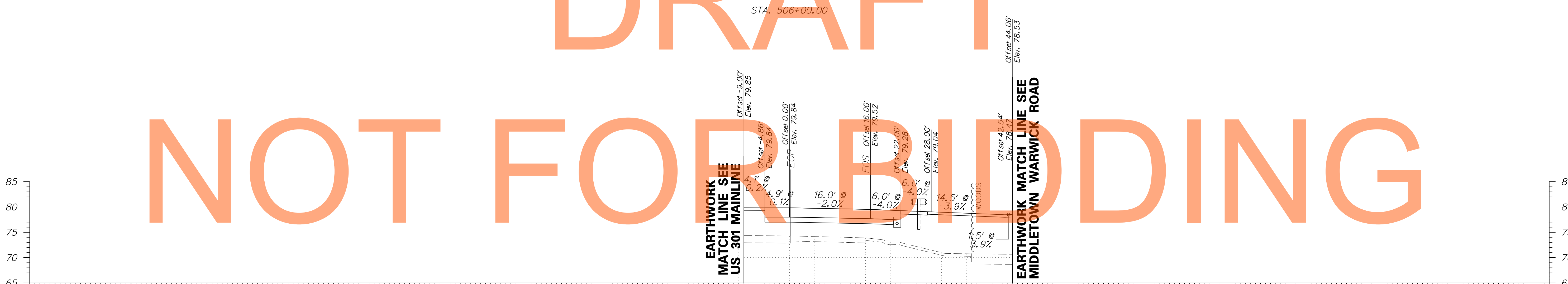
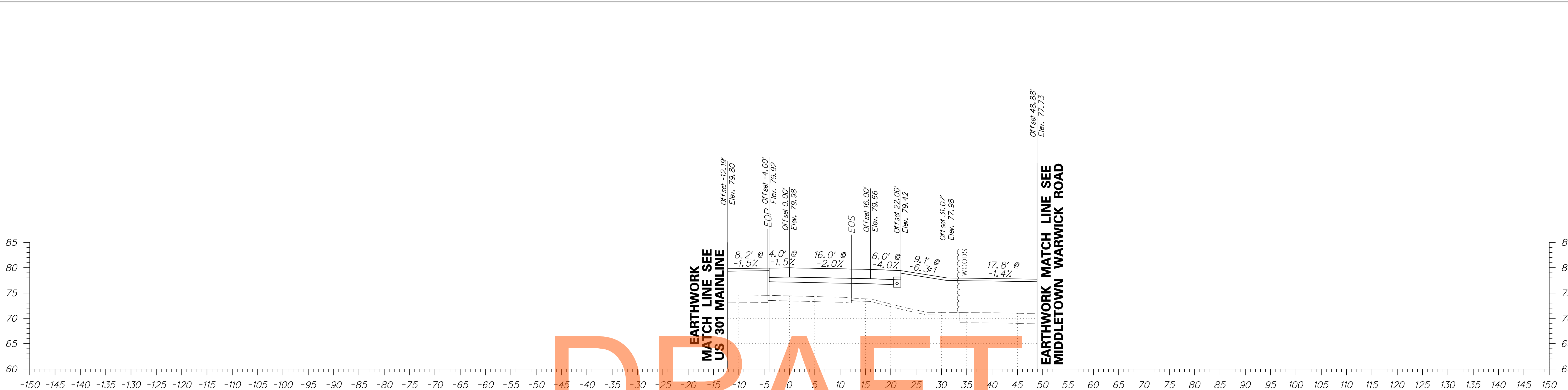

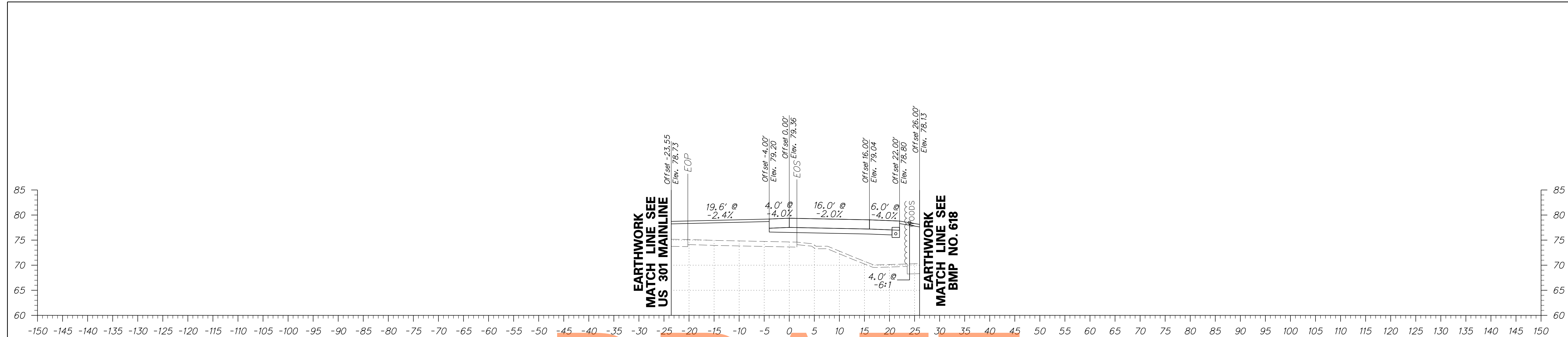

DRAFT

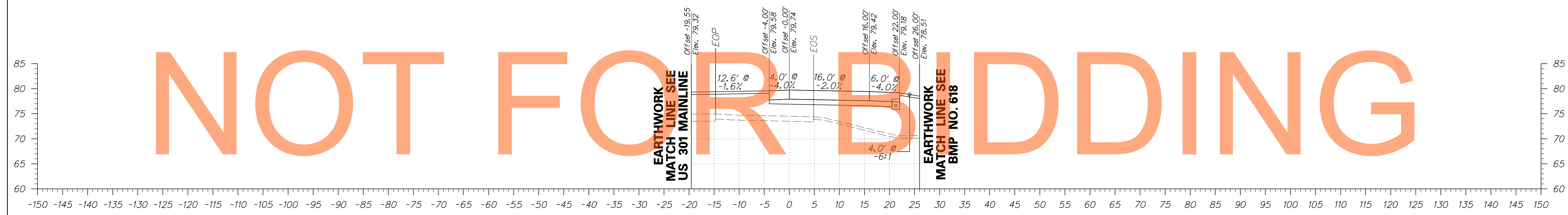

NOT FOR BIDDING

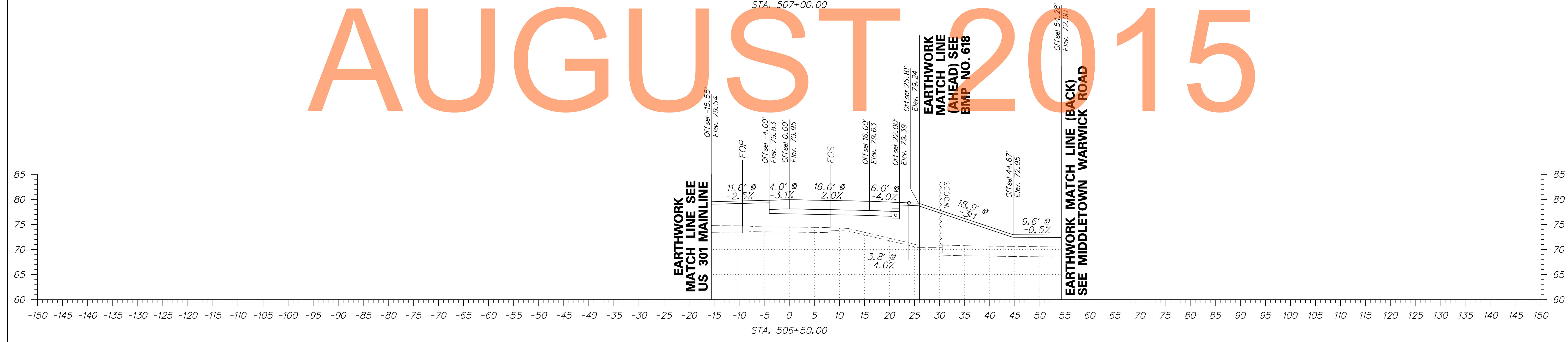

AUGUST 2015



ADDENDUMS / REVISIONS	

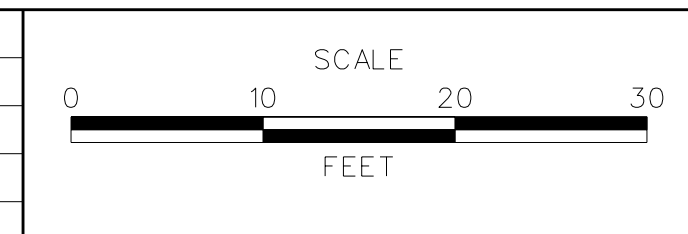

**US 301  
MARYLAND STATE LINE  
TO LEVELS ROAD**

CONTRACT T200811301	BRIDGE NO.
COUNTY NEW CASTLE	DESIGNED BY: JEG
	CHECKED BY: MFM

<b>CROSS SECTIONS RAMP A</b>	SHEET NO. 282
	TOTAL SHTS. 539

DRAFT

NOT FOR BIDDING

AUGUST 2015

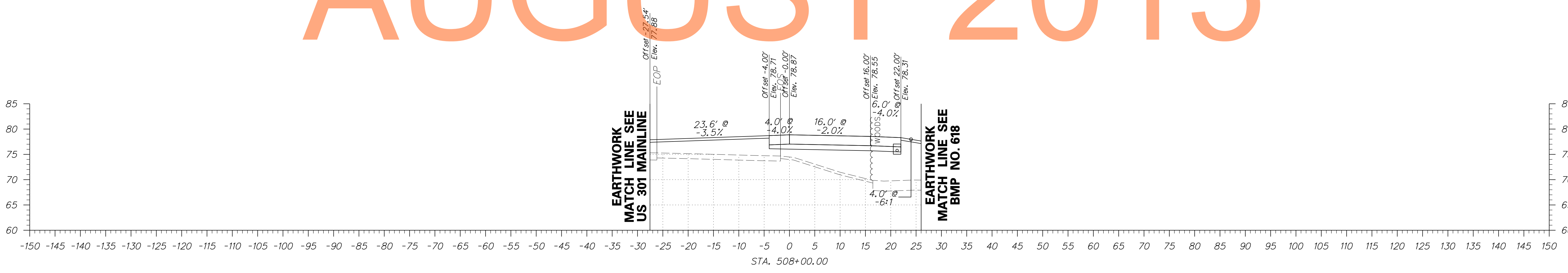
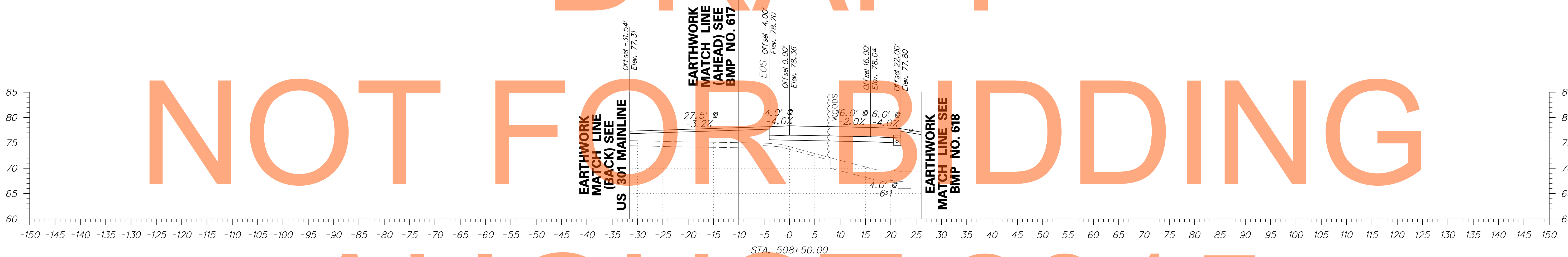
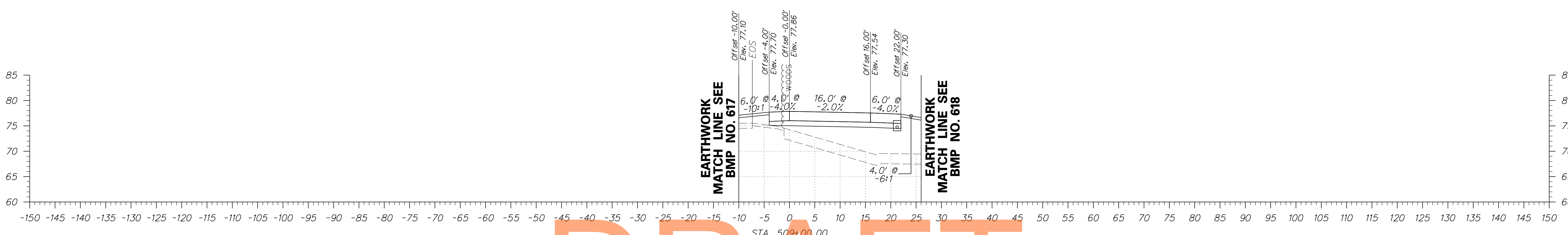

ADDENDUMS / REVISIONS	

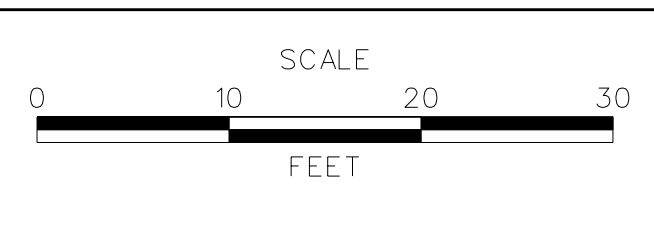

**US 301  
MARYLAND STATE LINE  
TO LEVELS ROAD**

CONTRACT T200811301	BRIDGE NO.
COUNTY NEW CASTLE	DESIGNED BY: JEG
	CHECKED BY: MFM

<b>CROSS SECTIONS RAMP A</b>	SHEET NO. 283
	TOTAL SHTS. 539

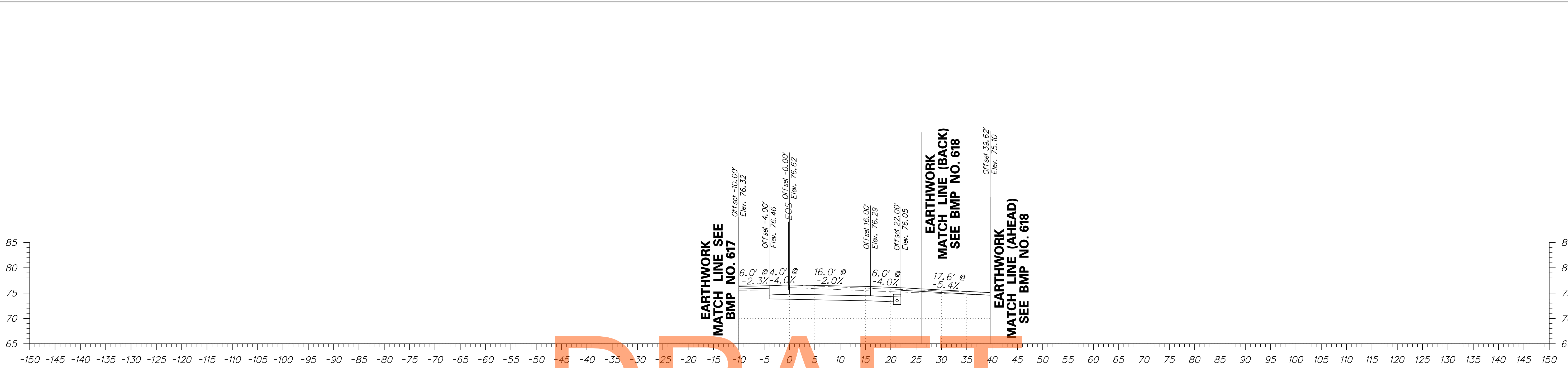

DRAFT

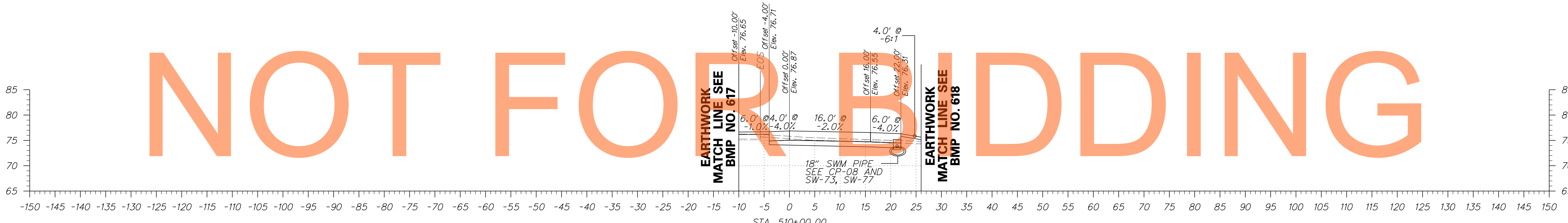

NOT FOR BIDDING

AUGUST 2015

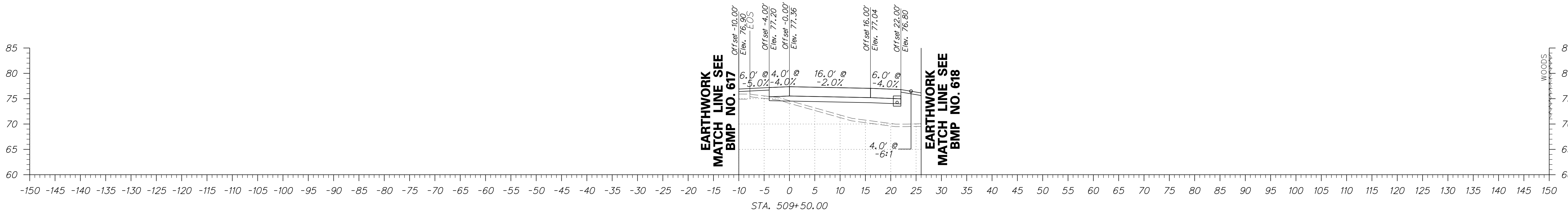

ADDENDUMS / REVISIONS	

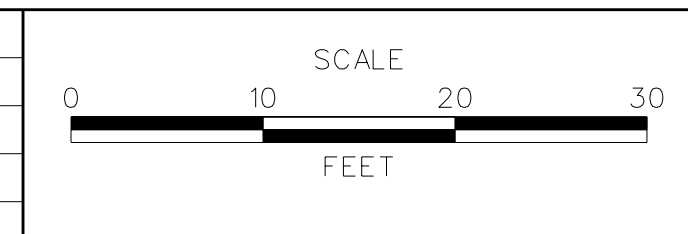

**US 301  
MARYLAND STATE LINE  
TO LEVELS ROAD**

CONTRACT T200811301	BRIDGE NO. 
COUNTY NEW CASTLE	DESIGNED BY: JEG CHECKED BY: MFM

<b>CROSS SECTIONS RAMP A</b>	SHEET NO. 284
	TOTAL SHTS. 539

# DRAFT

# NOT FOR BIDDING

# AUGUST 2015

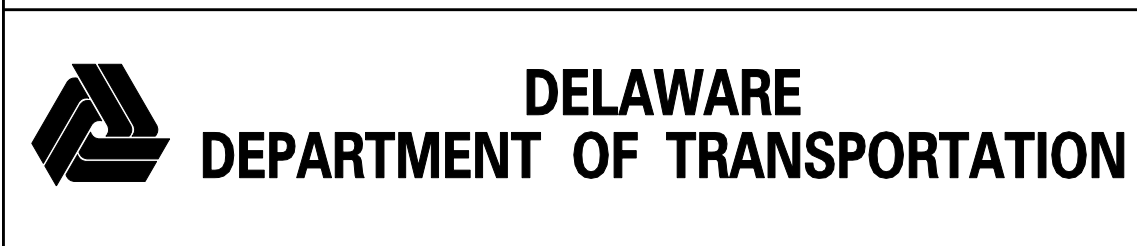
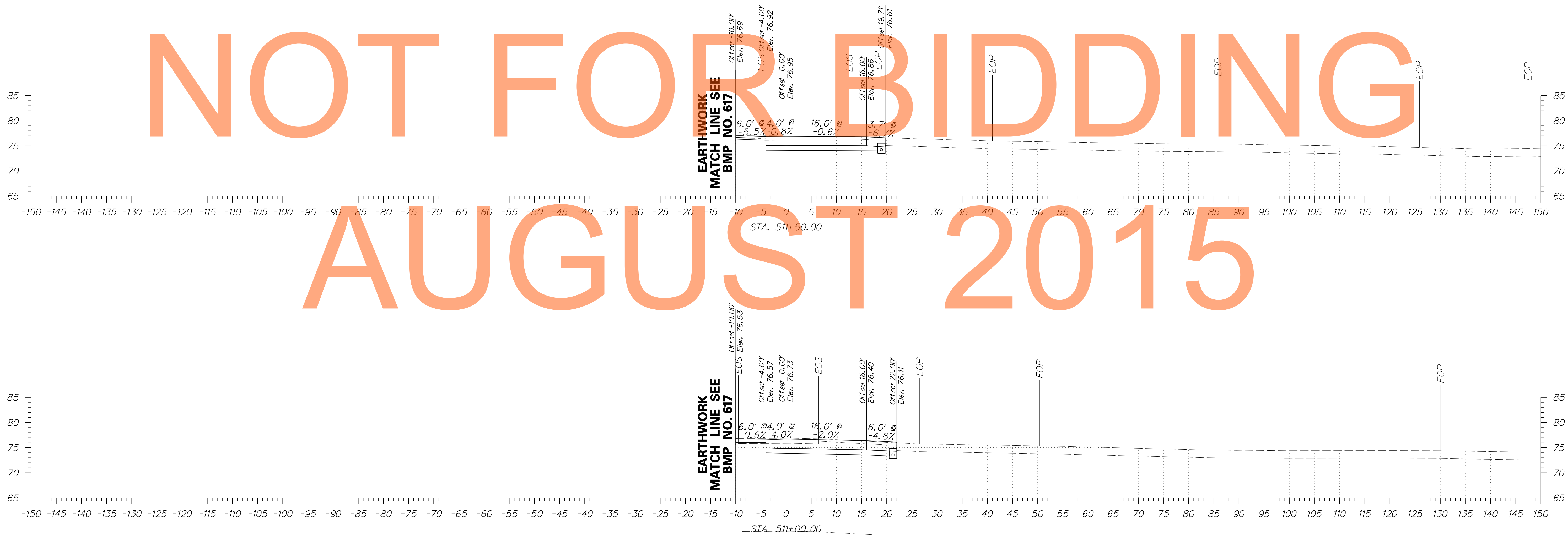

ADDENDUMS / REVISIONS	

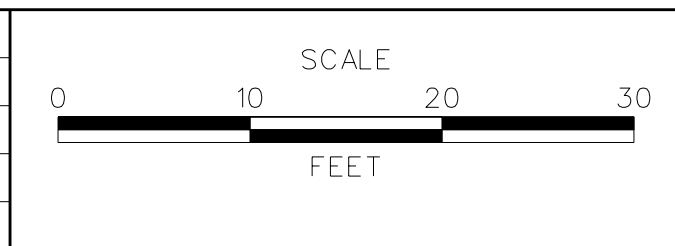

**US 301  
MARYLAND STATE LINE  
TO LEVELS ROAD**

CONTRACT T200811301	BRIDGE NO.
COUNTY NEW CASTLE	DESIGNED BY: JEG
	CHECKED BY: MFM

<b>CROSS SECTIONS RAMP A</b>	SHEET NO. 285
	TOTAL SHTS. 539

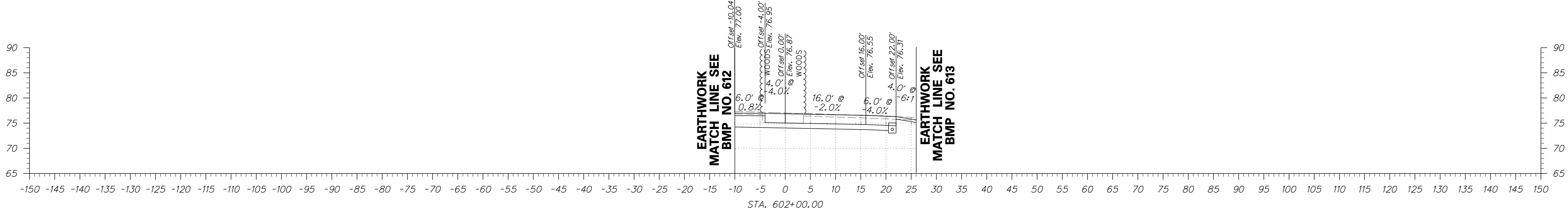
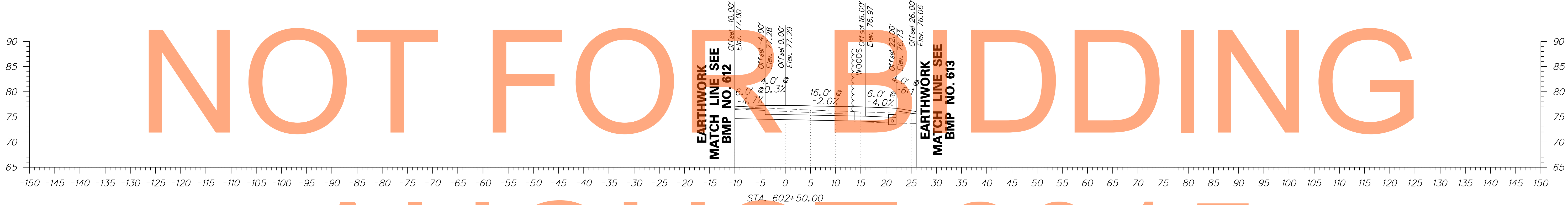
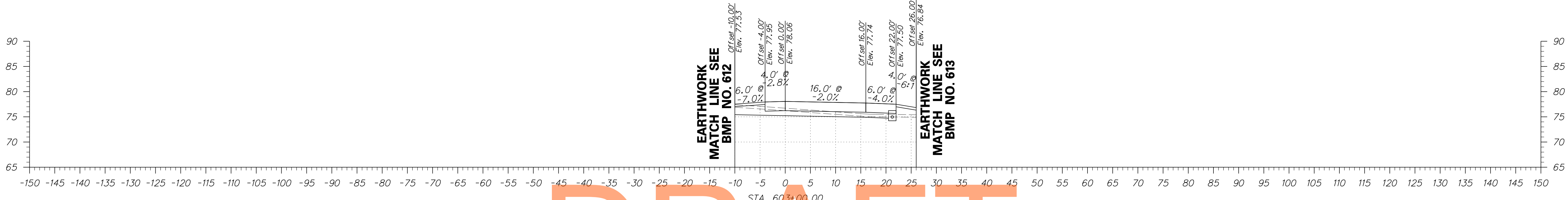

DRAFT

NOT FOR BIDDING

AUGUST 2015

ADDENDUMS / REVISIONS	

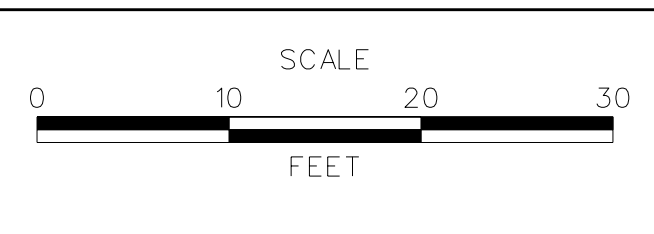

**US 301**  
**MARYLAND STATE LINE**  
**TO LEVELS ROAD**

CONTRACT T200811301	BRIDGE NO. 
COUNTY NEW CASTLE	DESIGNED BY: JEG
	CHECKED BY: MFM

<b>CROSS SECTIONS</b> <b>RAMP B</b>	SHEET NO. 286
	TOTAL SHTS. 539

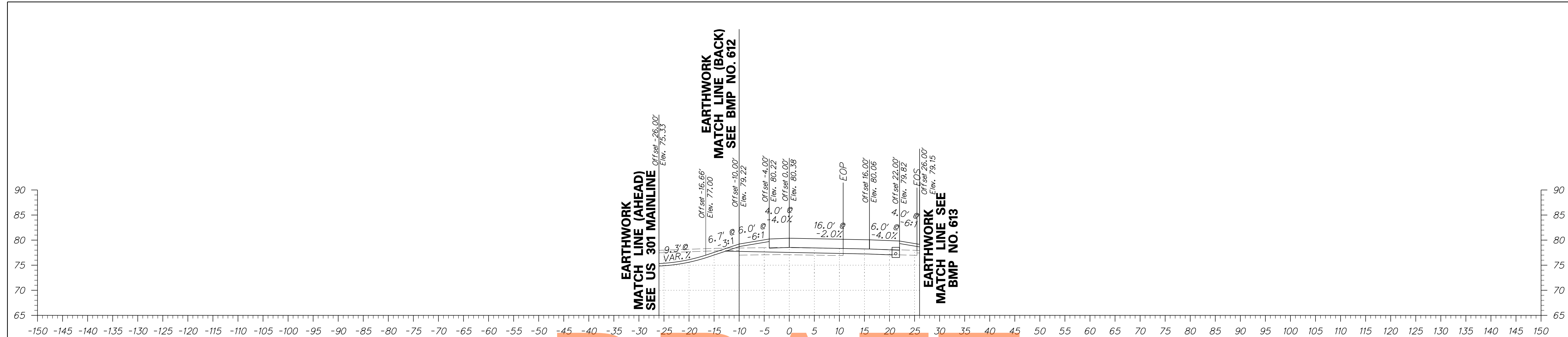

DRAFT

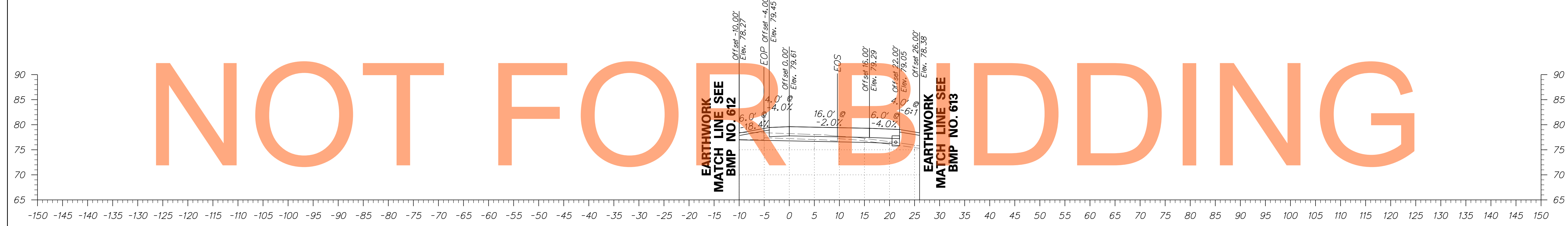

AUGUST 2015

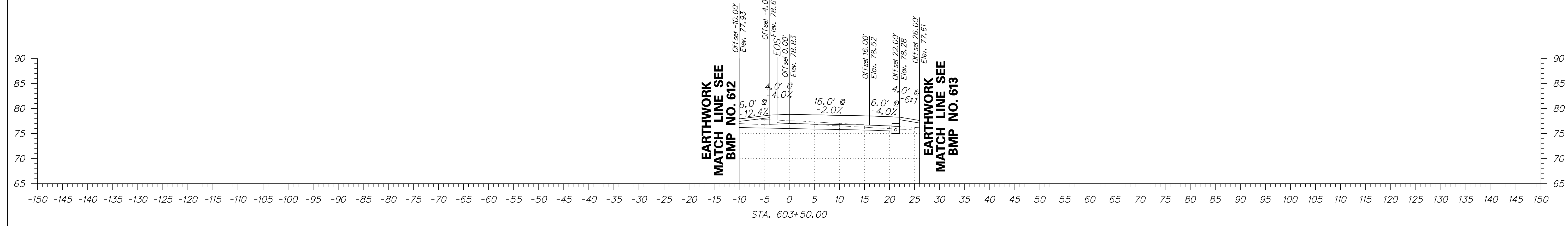

ADDENDUMS / REVISIONS	

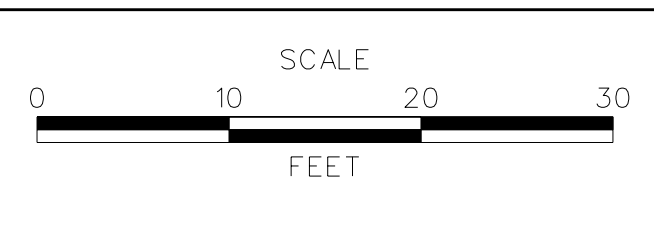

**US 301 MARYLAND STATE LINE TO LEVELS ROAD**

CONTRACT T200811301	BRIDGE NO. 
COUNTY NEW CASTLE	DESIGNED BY: JEG CHECKED BY: MFM

<b>CROSS SECTIONS RAMP B</b>	SHEET NO. 287
	TOTAL SHTS. 539

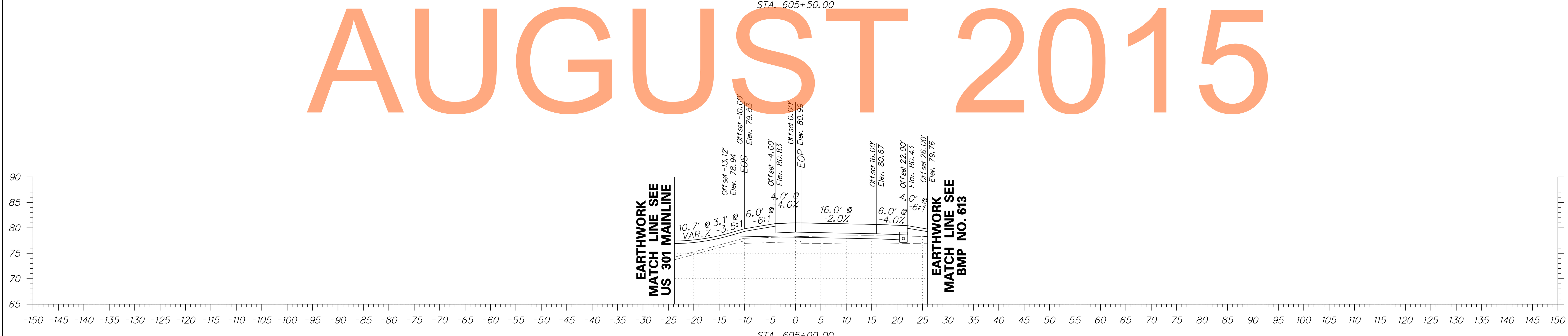
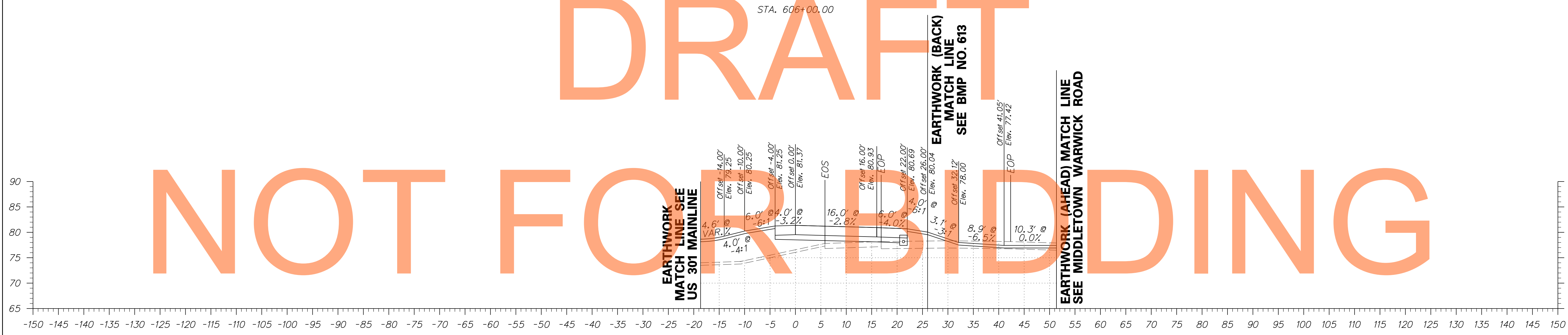
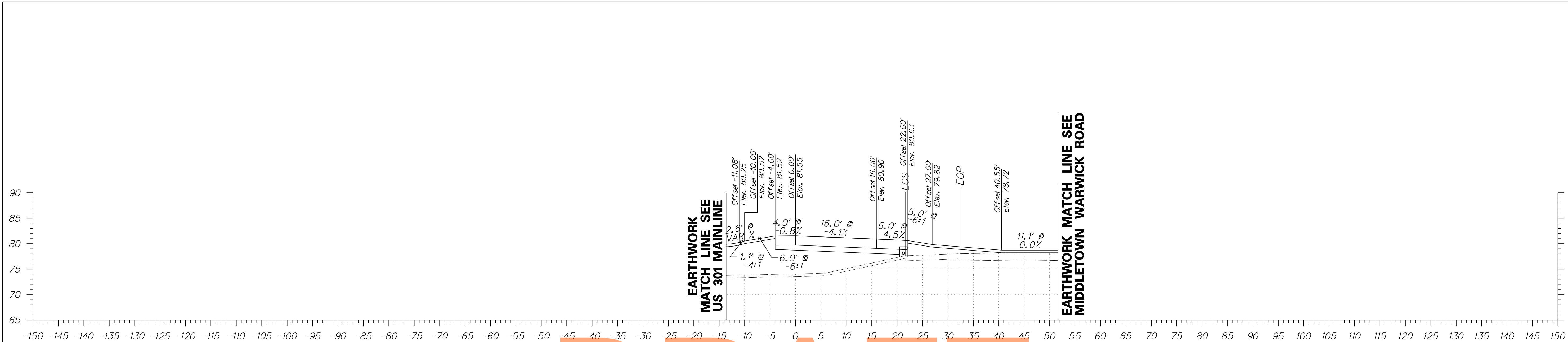

DRAFT

NOT FOR BIDDING

AUGUST 2015



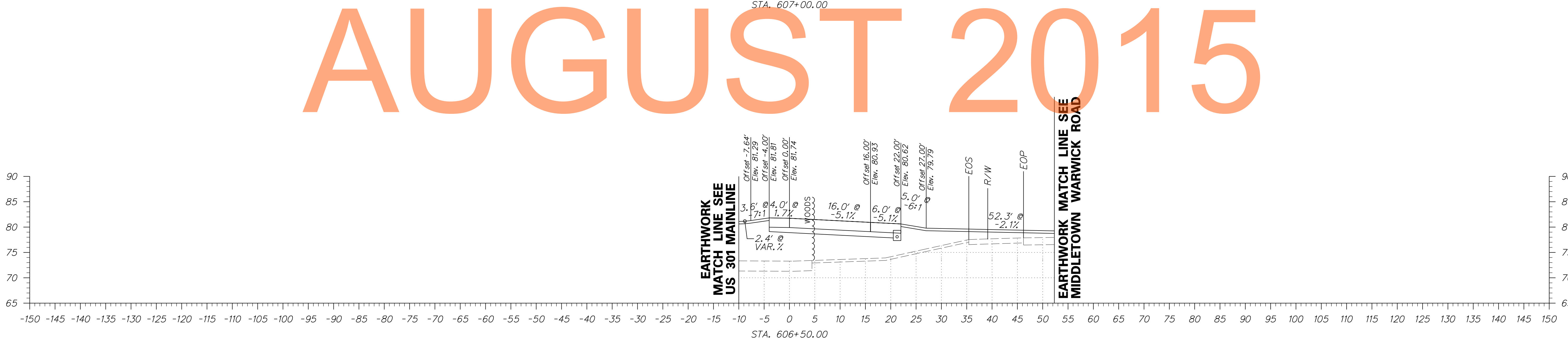
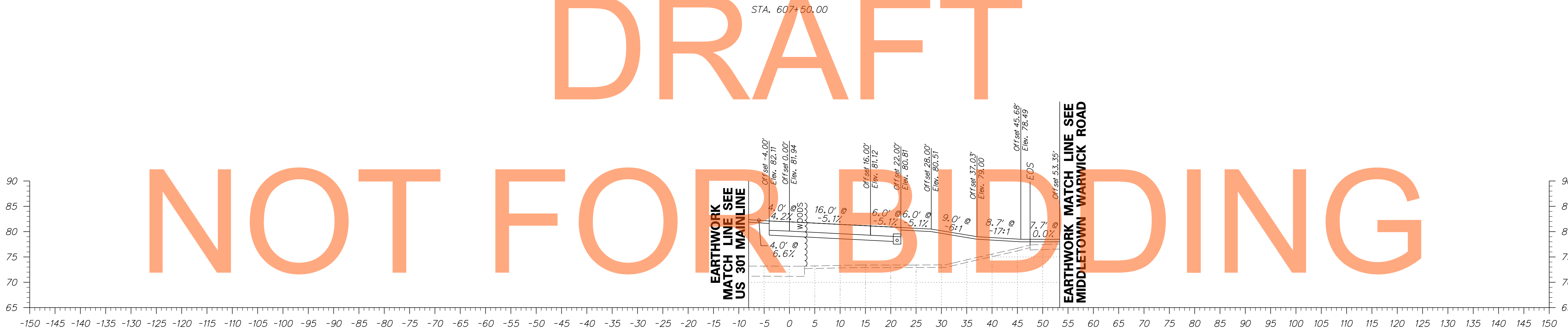
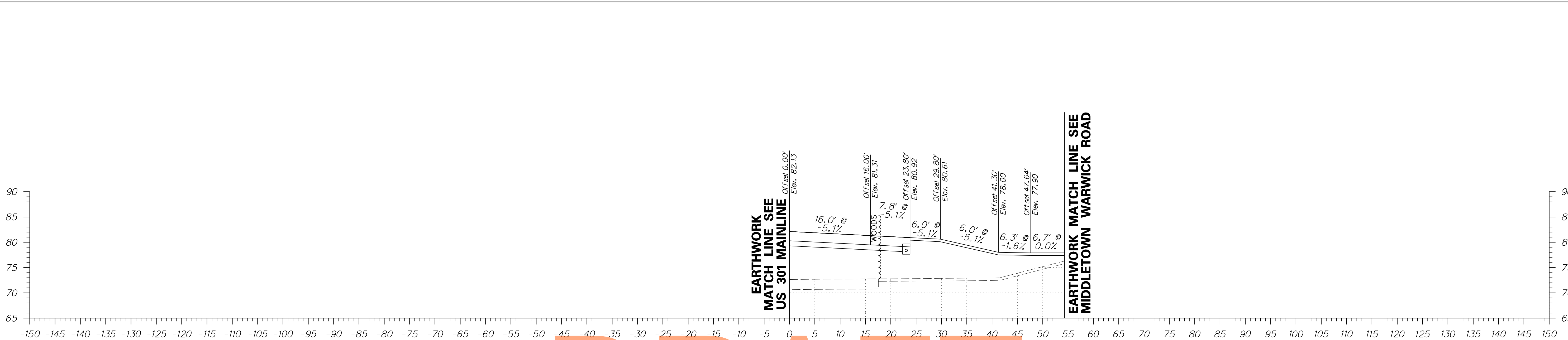

DRAFT

NOT FOR BIDDING

AUGUST 2015

<b>DELAWARE DEPARTMENT OF TRANSPORTATION</b>	ADDENDUMS / REVISIONS	<p>SCALE</p> <p>FEET</p>	<b>US 301 MARYLAND STATE LINE TO LEVELS ROAD</b>		CONTRACT T200811301	BRIDGE NO. 	<b>CROSS SECTIONS RAMP B</b>	SHEET NO. 289
					COUNTY NEW CASTLE	DESIGNED BY: JEG		TOTAL SHTS. 539
						CHECKED BY: MFM		

# DRAFT

# NOT FOR BIDDING

# AUGUST 2015

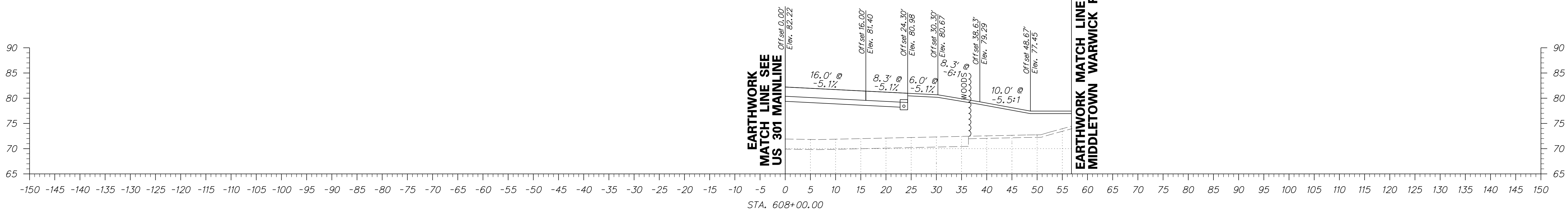
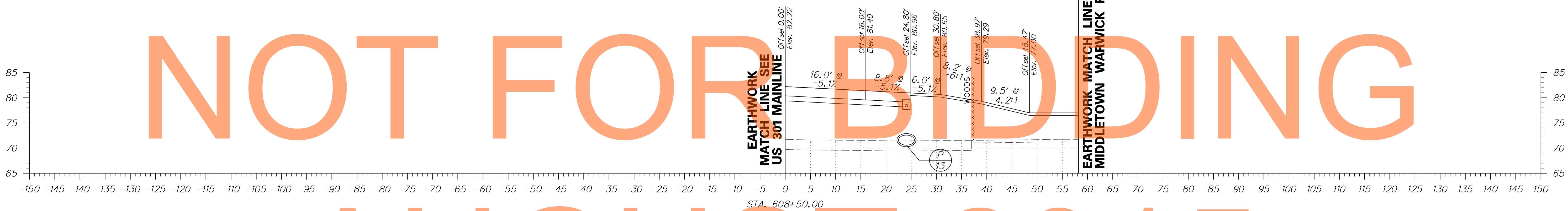

ADDENDUMS / REVISIONS	

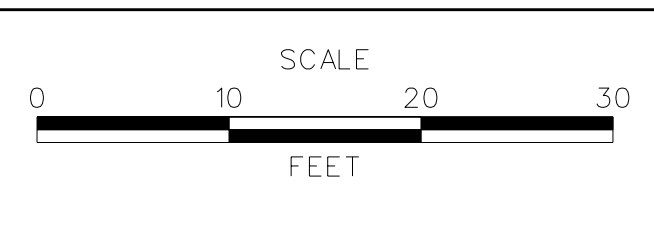

**US 301  
MARYLAND STATE LINE  
TO LEVELS ROAD**

CONTRACT T200811301	BRIDGE NO.
COUNTY NEW CASTLE	DESIGNED BY: JEG
	CHECKED BY: MFM

<b>CROSS SECTIONS RAMP B</b>	SHEET NO. 290
	TOTAL SHTS. 539

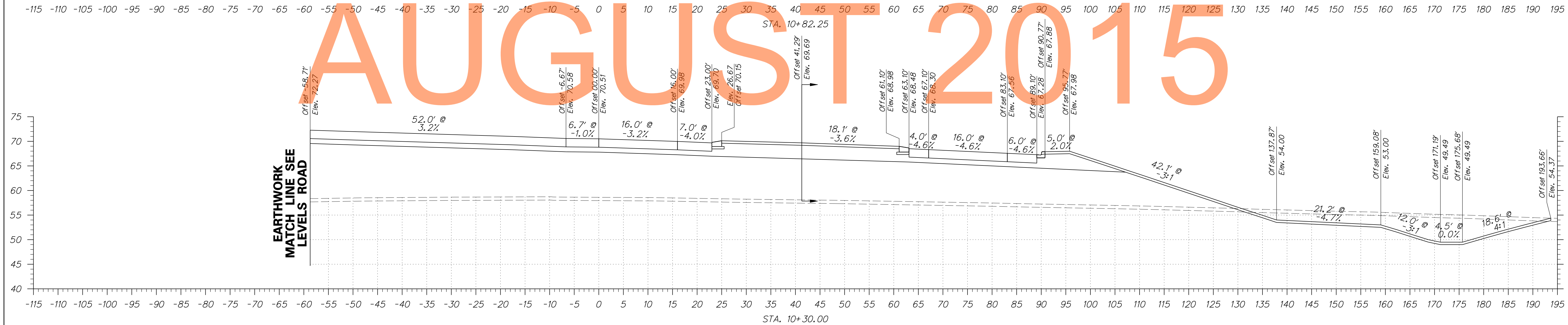
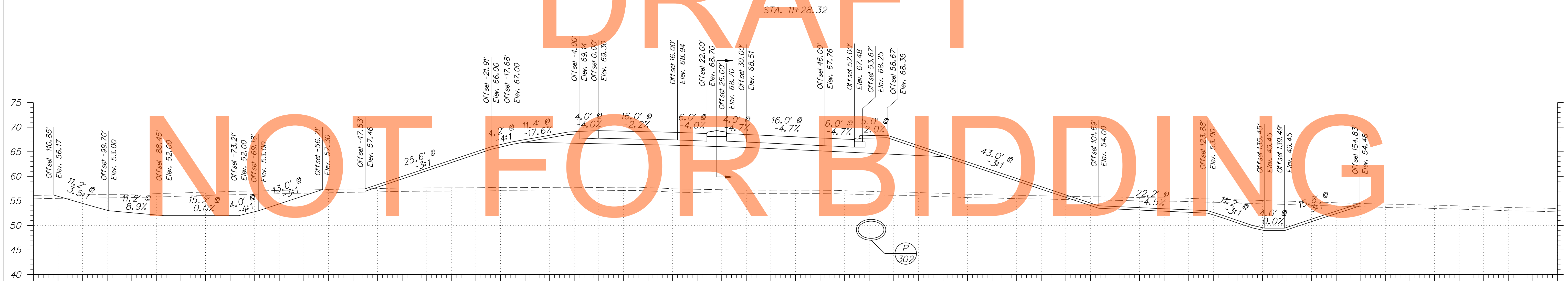
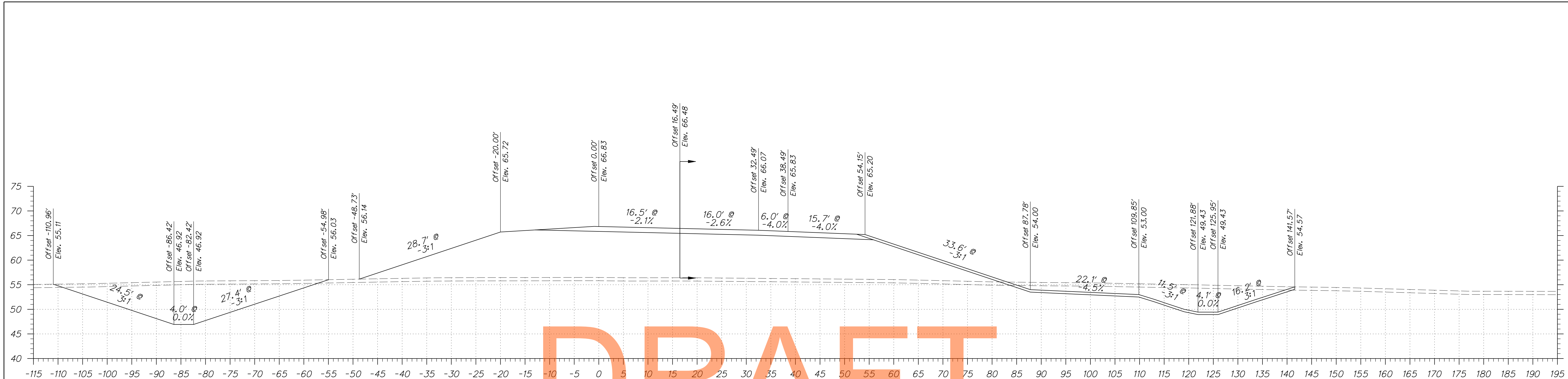

DRAFT  
NOT FOR BIDDING  
AUGUST 2015

ADDENDUMS / REVISIONS	

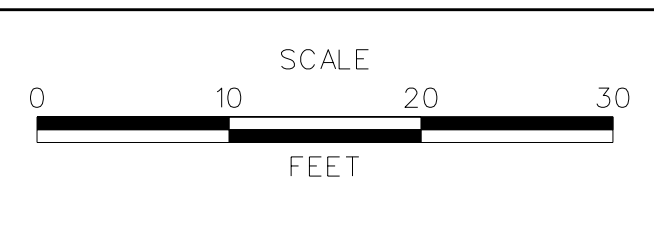

**US 301**  
**MARYLAND STATE LINE**  
**TO LEVELS ROAD**

CONTRACT T200811301	BRIDGE NO.
COUNTY NEW CASTLE	DESIGNED BY: JEG
	CHECKED BY: MFM

**CROSS SECTIONS**  
**RAMP C**

SHEET NO. 291
TOTAL SHTS. 539

# DRAFT

# NOT FOR BIDDING

# AUGUST 2015

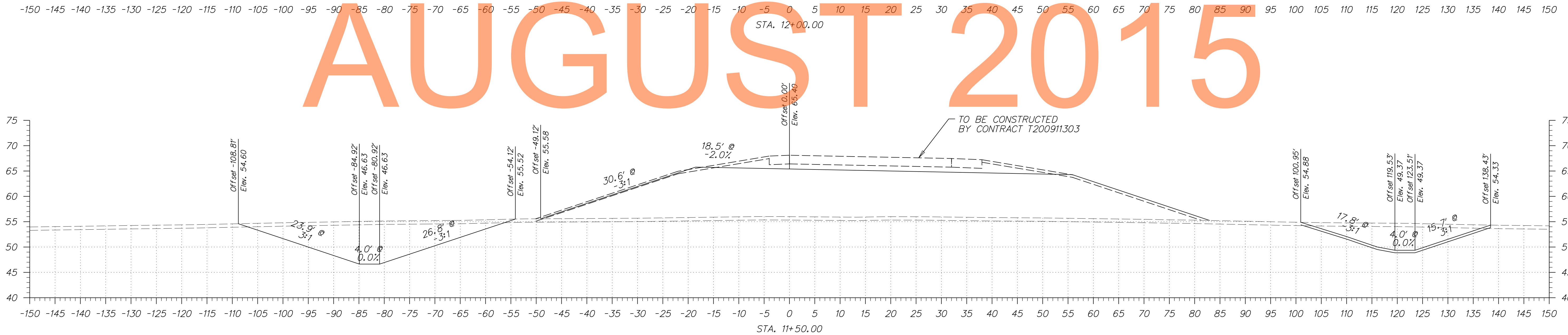
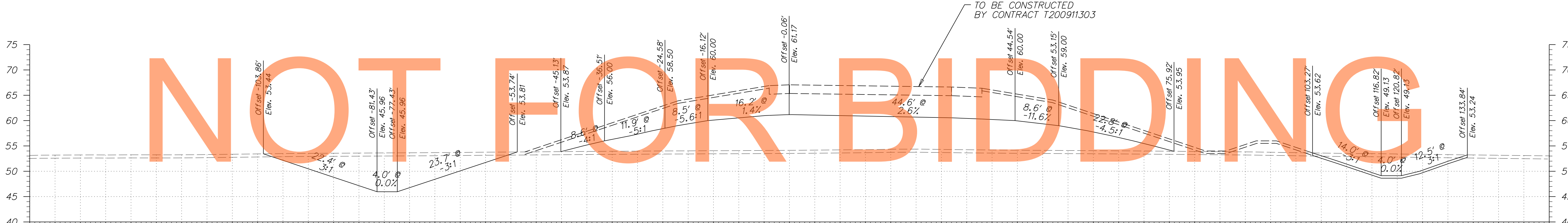
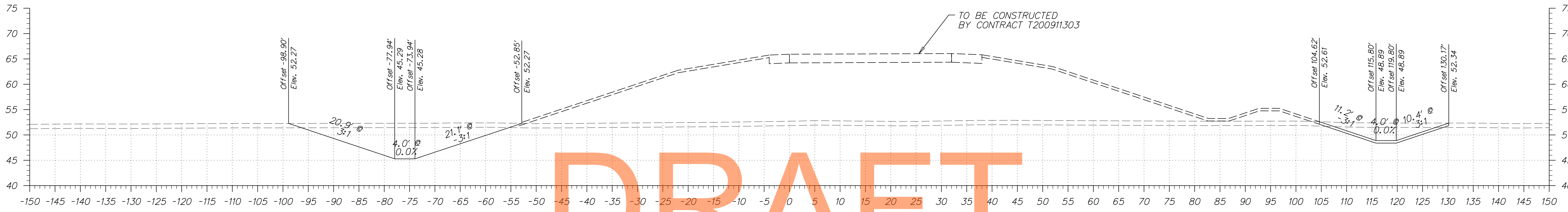

ADDENDUMS / REVISIONS	

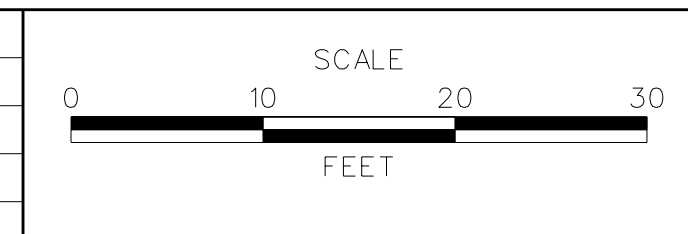

**US 301  
MARYLAND STATE LINE  
TO LEVELS ROAD**

CONTRACT T200811301	BRIDGE NO.
COUNTY NEW CASTLE	DESIGNED BY: JEG
	CHECKED BY: MFM

<b>CROSS SECTIONS RAMP C</b>	SHEET NO. 292
	TOTAL SHTS. 539

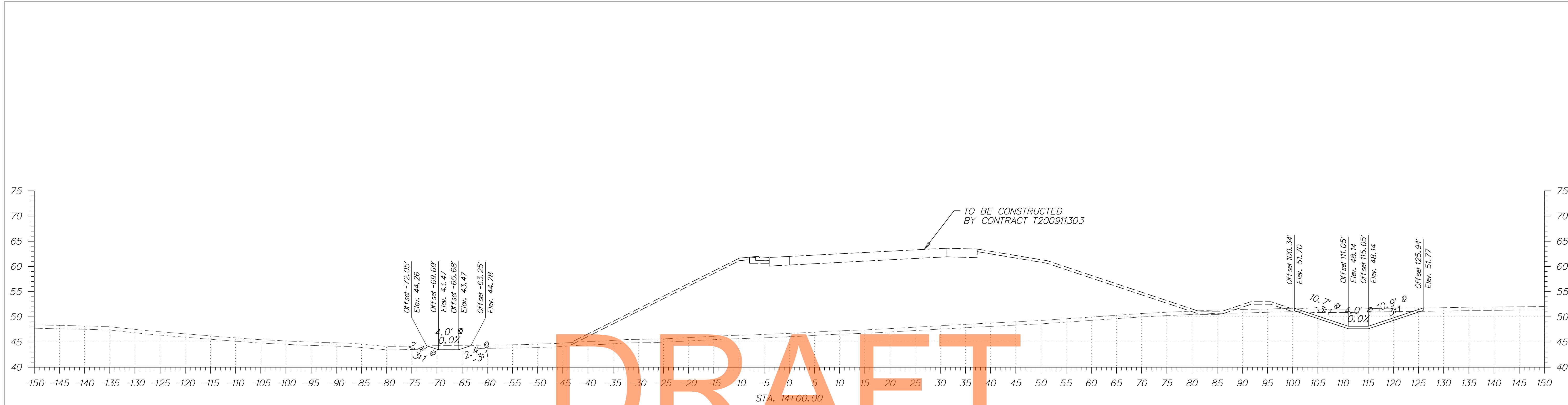

DRAFT

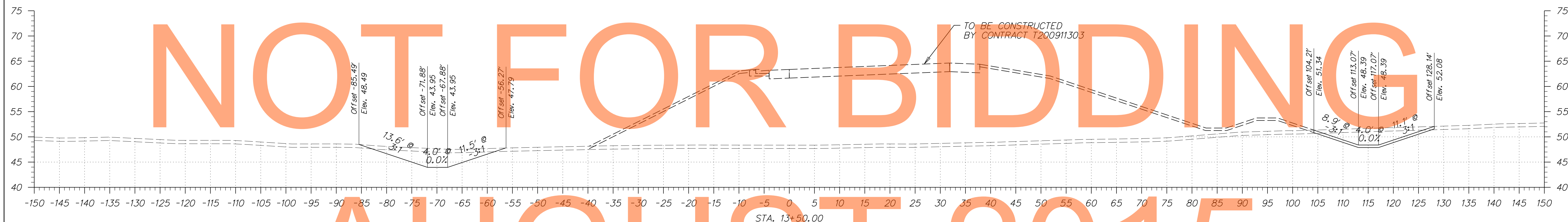

NOT FOR BIDDING

AUGUST 2015

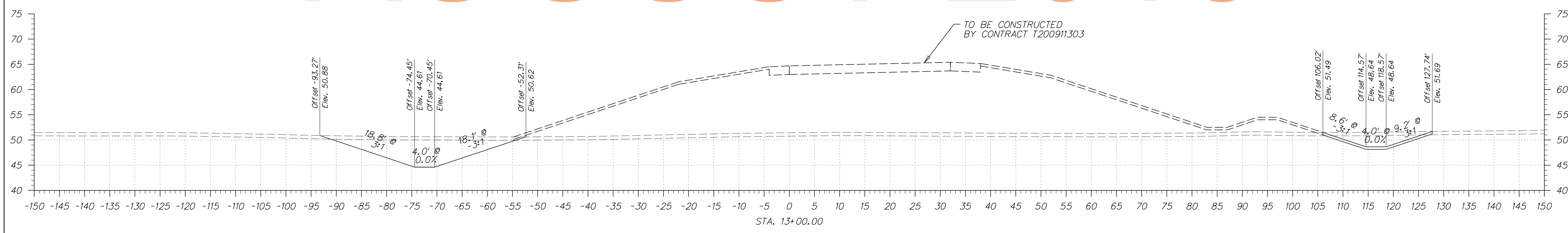

ADDENDUMS / REVISIONS

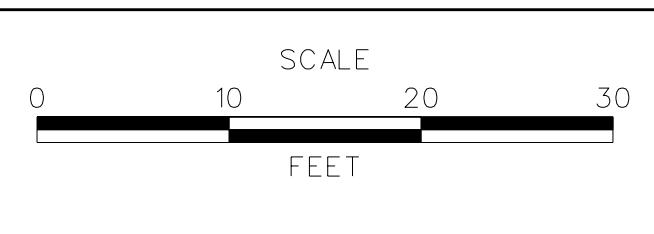

US 301  
MARYLAND STATE LINE  
TO LEVELS ROAD

CONTRACT T200811301	BRIDGE NO.
COUNTY NEW CASTLE	DESIGNED BY: JEG
	CHECKED BY: MFM

CROSS SECTIONS RAMP C	SHEET NO. 293
	TOTAL SHTS. 539

# DRAFT

# NOT FOR BIDDING

# AUGUST 2015

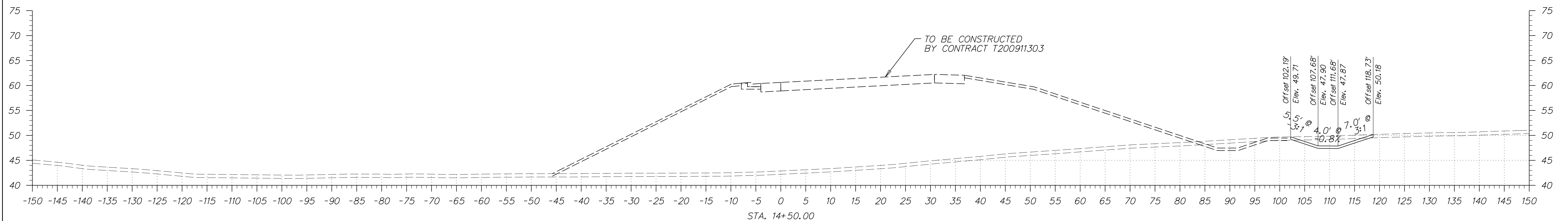

ADDENDUMS / REVISIONS

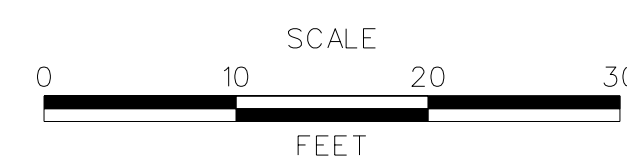



**US 301**  
**MARYLAND STATE LINE**  
**TO LEVELS ROAD**

CONTRACT T200811301	BRIDGE NO. 
COUNTY NEW CASTLE	DESIGNED BY: JEG CHECKED BY: MFM

**CROSS SECTIONS**  
**RAMP C**

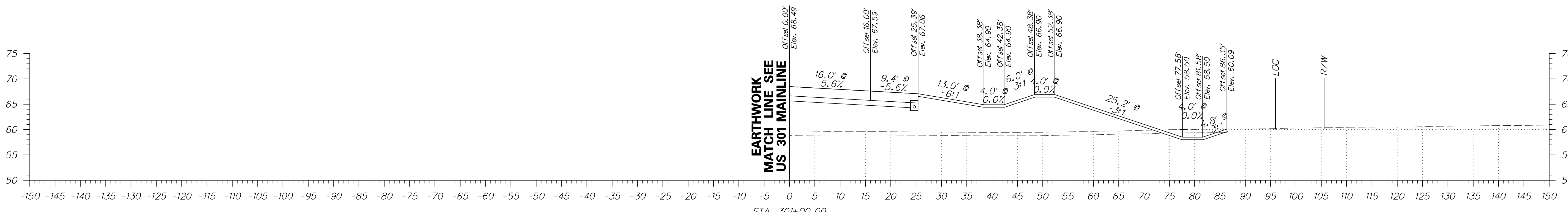
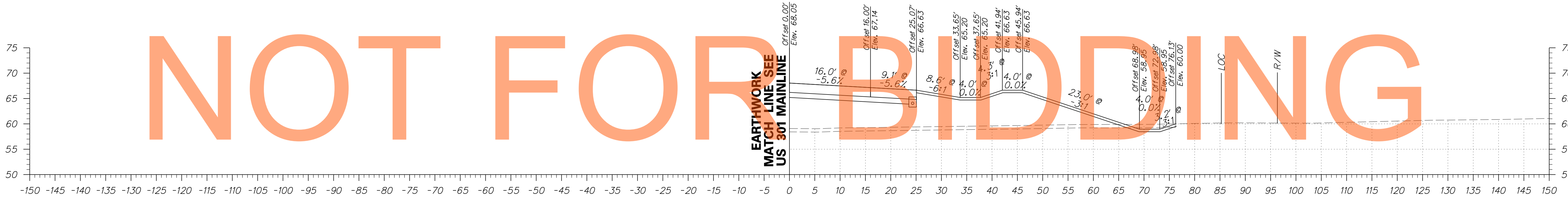
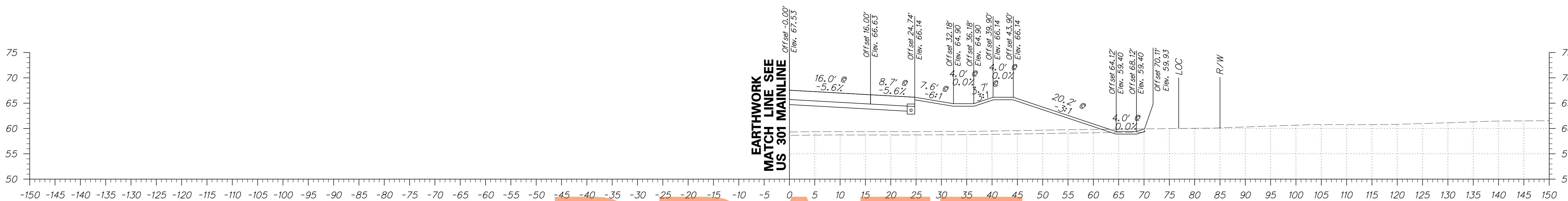
SHEET NO. 294
TOTAL SHTS. 539



DRAFT  
NOT FOR BIDDING  
AUGUST 2015

ADDENDUMS / REVISIONS	

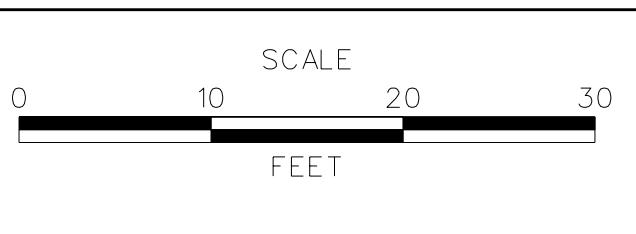

**US 301**  
**MARYLAND STATE LINE**  
**TO LEVELS ROAD**

CONTRACT T200811301	BRIDGE NO.
COUNTY NEW CASTLE	DESIGNED BY: JEG
	CHECKED BY: MFM

<b>CROSS SECTIONS</b> <b>RAMP D</b>	SHEET NO. 295
	TOTAL SHTS. 539

DRAFT

NOT FOR BIDDING

AUGUST 2015

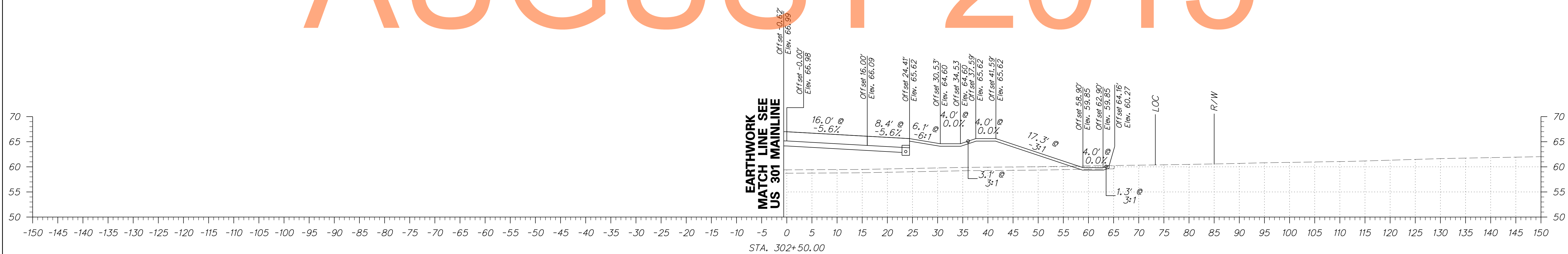
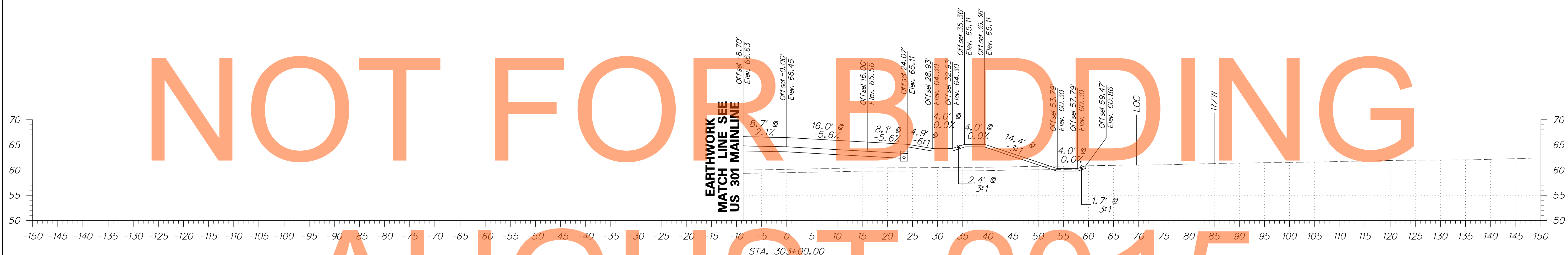
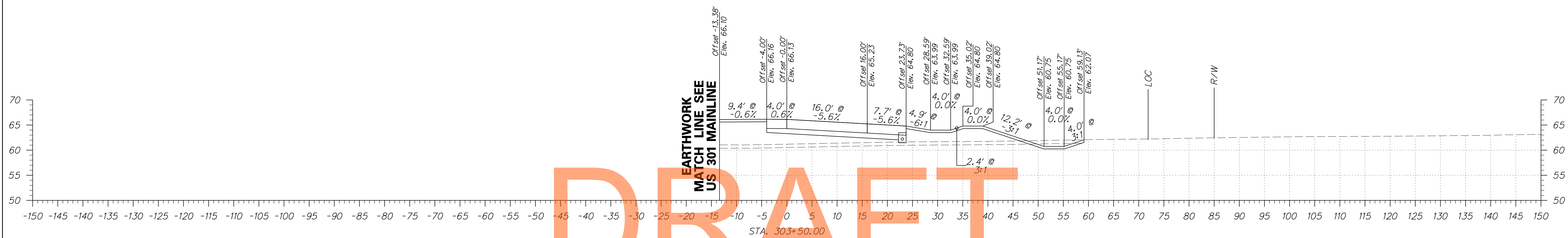



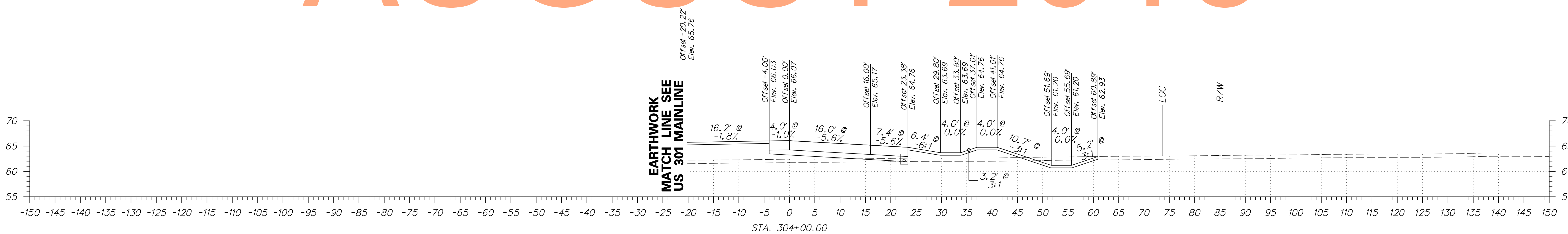
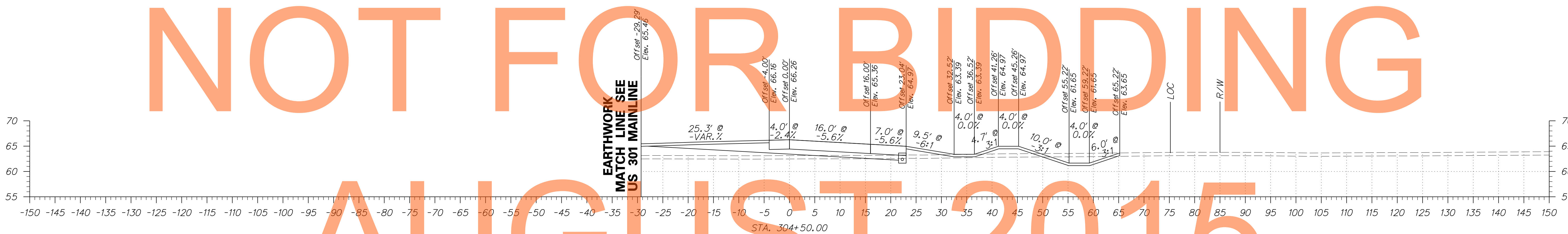
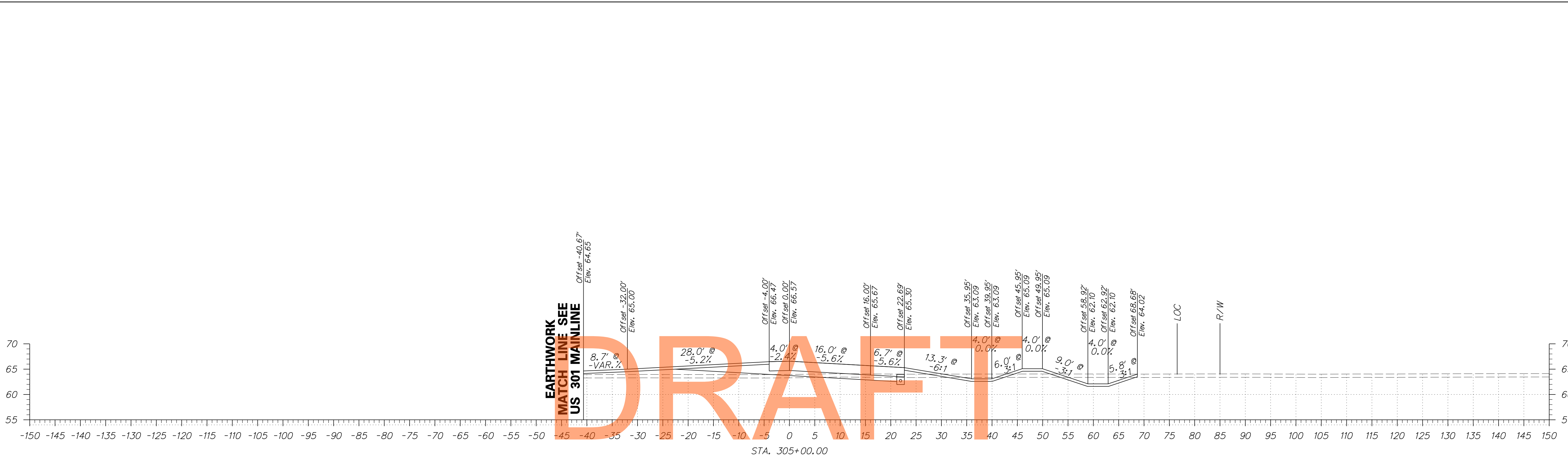

DRAFT

NOT FOR BIDDING

AUGUST 2015

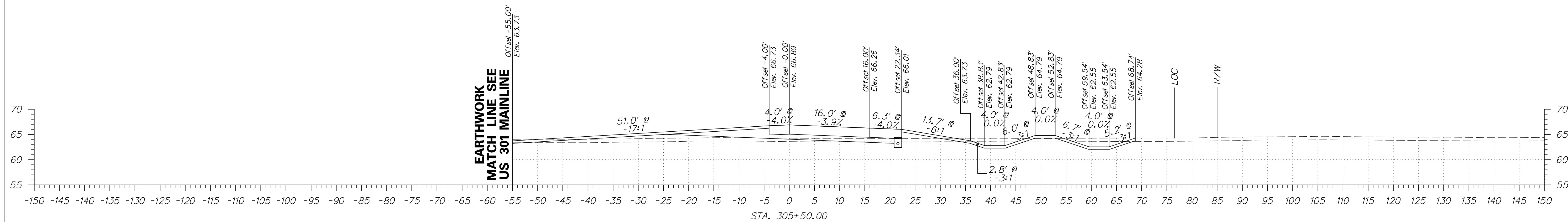
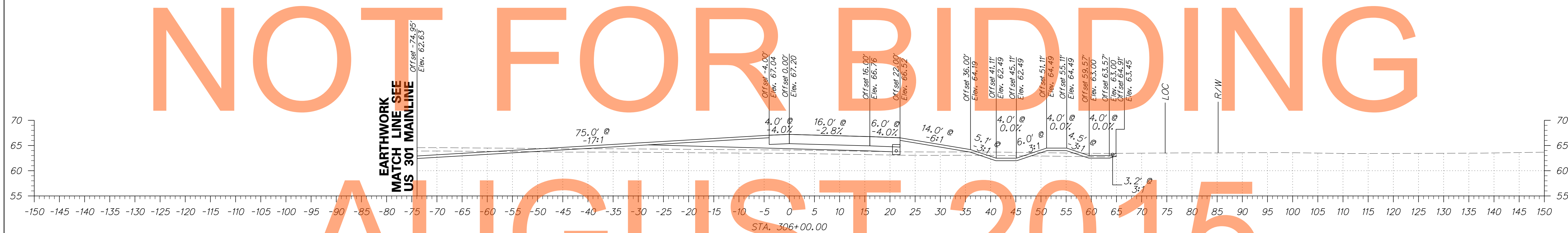
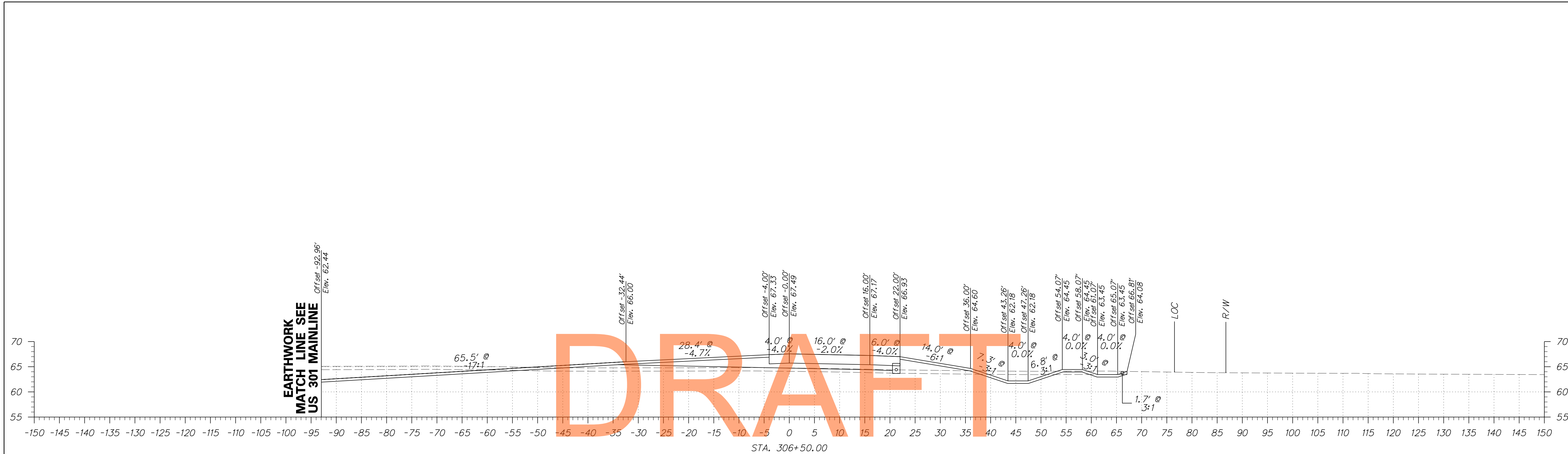

DRAFT

NOT FOR BIDDING

AUGUST 2015

EARTHWORK MATCH  
LINE - SEE US 301 MAINLINE

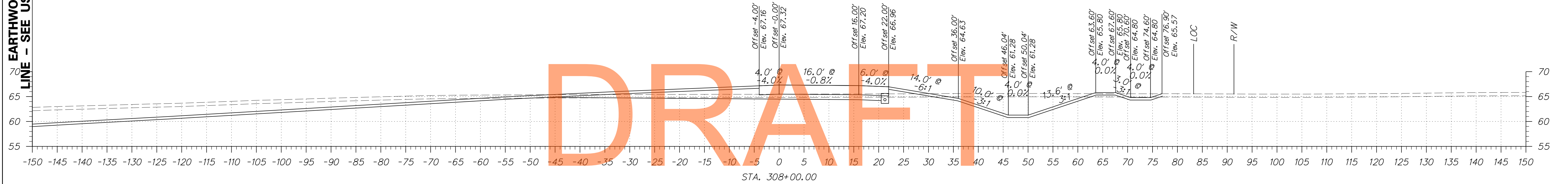

# DRAFT

EARTHWORK MATCH  
LINE SEE  
US 301 MAINLINE

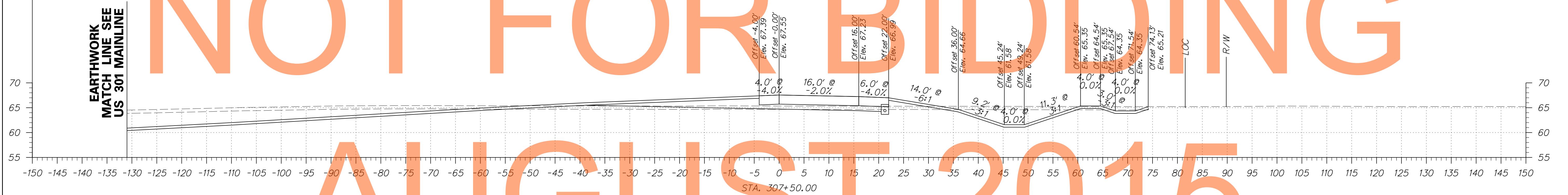

# AUGUST 2015

EARTHWORK MATCH  
LINE SEE  
US 301 MAINLINE

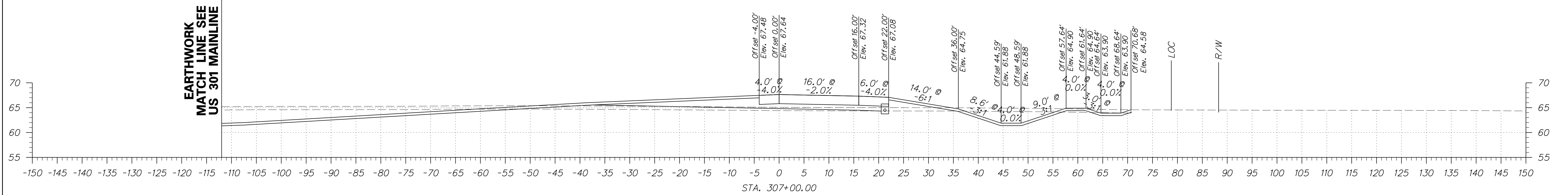

ADDENDUMS / REVISIONS

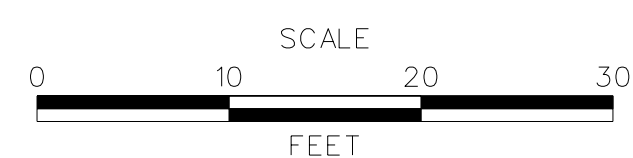

US 301  
MARYLAND STATE LINE  
TO LEVELS ROAD

CONTRACT	BRIDGE NO.
T200811301	
COUNTY	DESIGNED BY: JEG
NEW CASTLE	CHECKED BY: MFM

CROSS SECTIONS  
RAMP D

SHEET NO.
299
TOTAL SHTS.
539

EARTHWORK MATCH  
LINE - SEE US 301 MAINLINE

EARTHWORK MATCH  
LINE - SEE US 301 MAINLINE

EARTHWORK MATCH  
LINE - SEE US 301 MAINLINE

DRAFT

NOT FOR BIDDING

AUGUST 2015

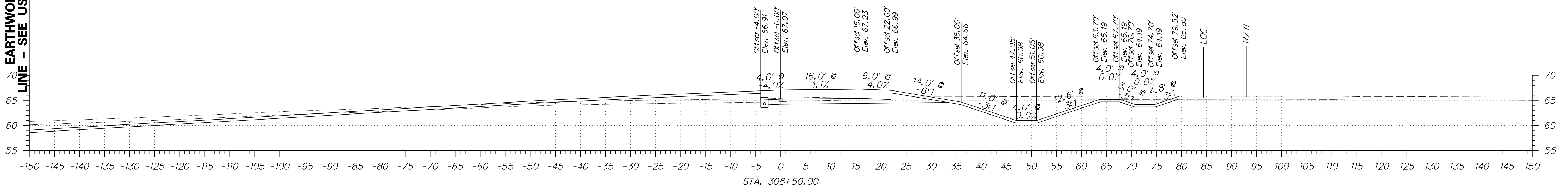
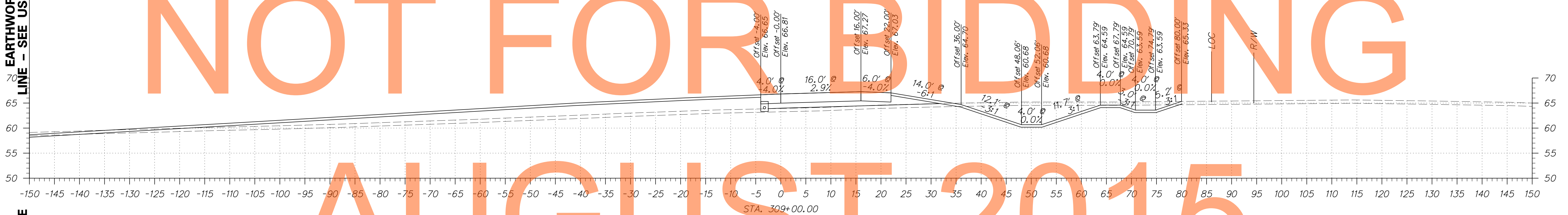
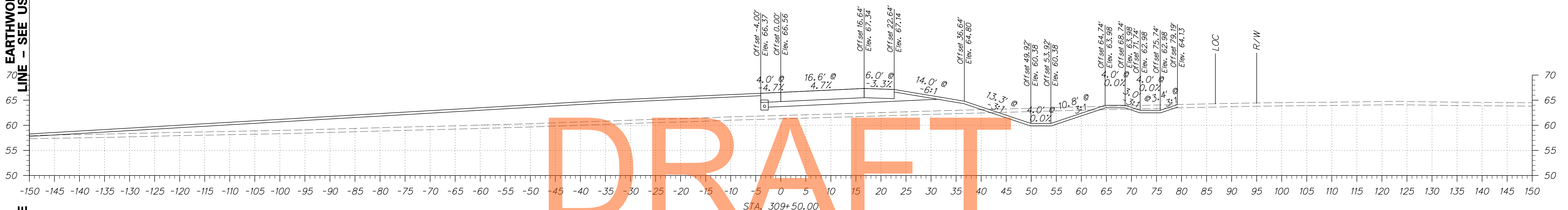

ADDENDUMS / REVISIONS	

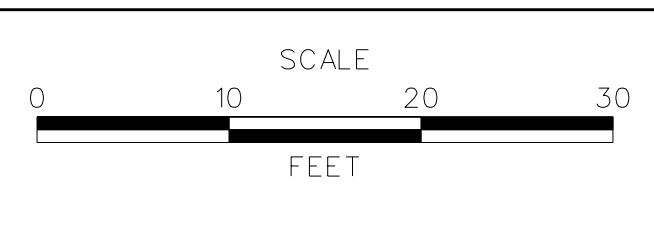

**US 301  
MARYLAND STATE LINE  
TO LEVELS ROAD**

CONTRACT T200811301	BRIDGE NO.
COUNTY NEW CASTLE	DESIGNED BY: JEG
	CHECKED BY: MFM

<b>CROSS SECTIONS RAMP D</b>	SHEET NO. 300
	TOTAL SHTS. 539