

NOT FOR BIDDING
AUGUST 2015

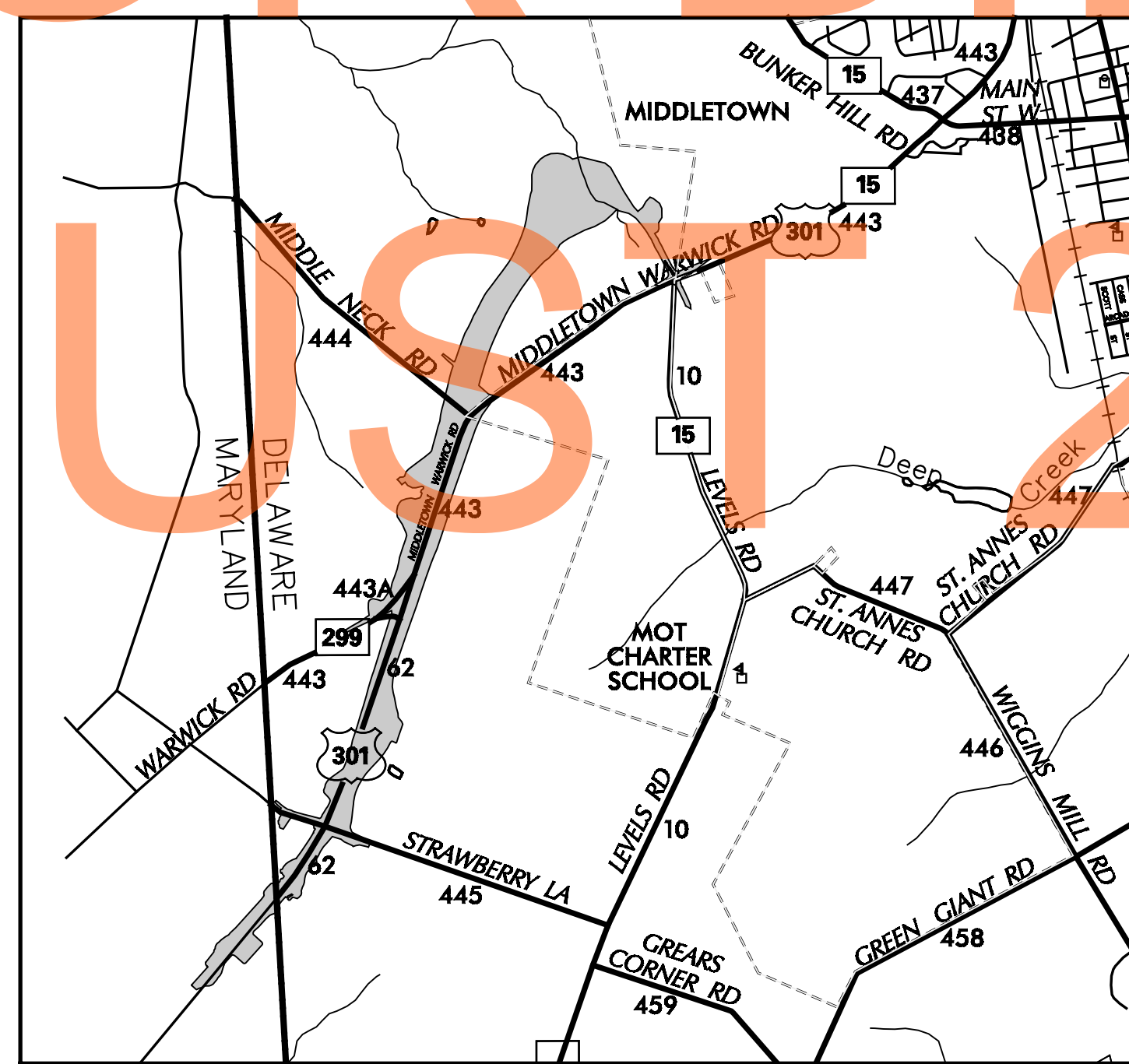

PROJECT VICINITY MAP
NOT TO SCALE

ADDENDUMS / REVISIONS	

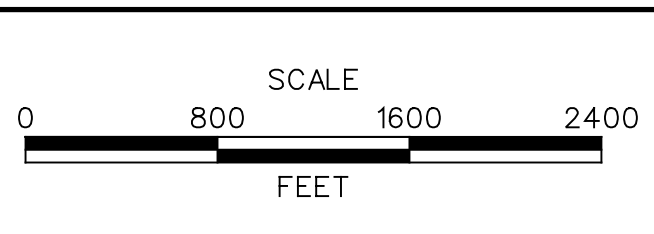

CONTRACT T200811301	BRIDGE NO.
COUNTY NEW CASTLE	DESIGNED BY: MAG/TAM
	CHECKED BY: PAH

SOILS LEGEND

A-3 SAND	A-2-7 CLAYEY SAND	A-7-4 SILTY CLAY
A-2 SAND & FINES	A-7-2 SANDY CLAY	A-7 CLAY
A-2-4 SILTY SAND	A-4 SILT	A-6 COLLOIDAL CLAY
A-4-2 SANDY SILT	A-4-7 CLAYEY SILT	A-5 MICA, DIATOMS

PLAN LOCATION OF SOIL BORINGS

BORING TARGETS AND PROFILES SCALE:
HORIZONTAL - NONE
VERTICAL - SEE PROFILE SHEETS

AO-ABOVE OPTIMUM
SAT-SATURATED
LIQ-LIQUEFIED

LL-LIQUID LIMIT (%)
PI-PLASTICITY INDEX (%)
NP-NON-PLASTIC
MDD-MAXIMUM DRY DENSITY (pcf)
OMC-OPTIMUM MOISTURE CONTENT (%)
USC-UNIFIED SOIL CLASSIFICATION
USDA-UNITED STATES DEPARTMENT OF AGRICULTURE CLASSIFICATION

TS-TOPSOIL
RM-ROOT MAT
BC-BITUMINOUS CONCRETE
SB-STONE BASE
PCC-PORTLAND CEMENT CONCRETE
RPPSA - ROCK PENETRATED BY POWER SOIL AUGER

w/GR-WITH GRAVEL
w/RF-WITH ROCK FRAGMENTS

NOTES:
SOIL SYMBOLS DENOTE MSMT CLASSIFICATIONS
ALL DIMENSIONS, DEPTHS AND ELEVATIONS ARE NOTED IN FEET
AN ASTERISK AT THE TOP DEPTH OF STRATA INDICATES THAT STRATA WAS VISUALLY CLASSIFIED BY DRILLER
MDD & OMC PER A.A.S.H.T.O. DESIGNATION T-180
N PER A.A.S.H.T.O. DESIGNATION T-206

UNLESS OTHERWISE NOTED ON PLANS, ALL SOIL SURVEY BORINGS FOR ROADWAY CONSTRUCTION WERE LEFT OPEN FOR 24 HOURS WITH NO EXCESS MOISTURE OR FREE WATER ENCOUNTERED DURING TIME OF SOIL SURVEY (insert date of soil investigation)

EXAMPLE SOIL BORING PROFILE

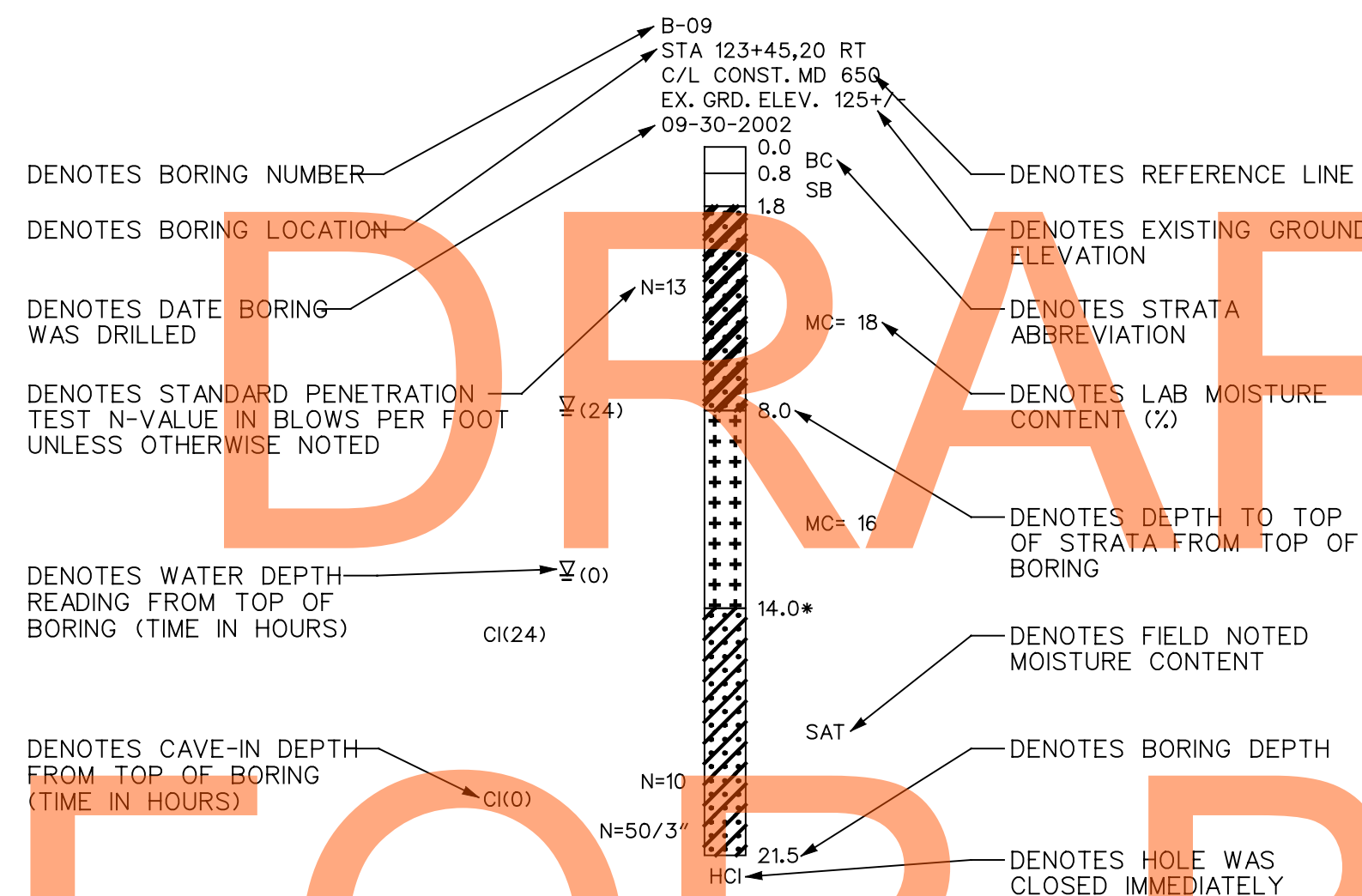

BORING NUMBER	SAMPLE DEPTH	LL	PI	USDA	USC	MDD	OMC	REMARKS
B-09	1.8 - 8.0	18	NP	SANDY LOAM	-	-	-	w/GR
B-09	8.0 - 14.0	41	22	SILTY CLAY LOAM	CL	121	12	-

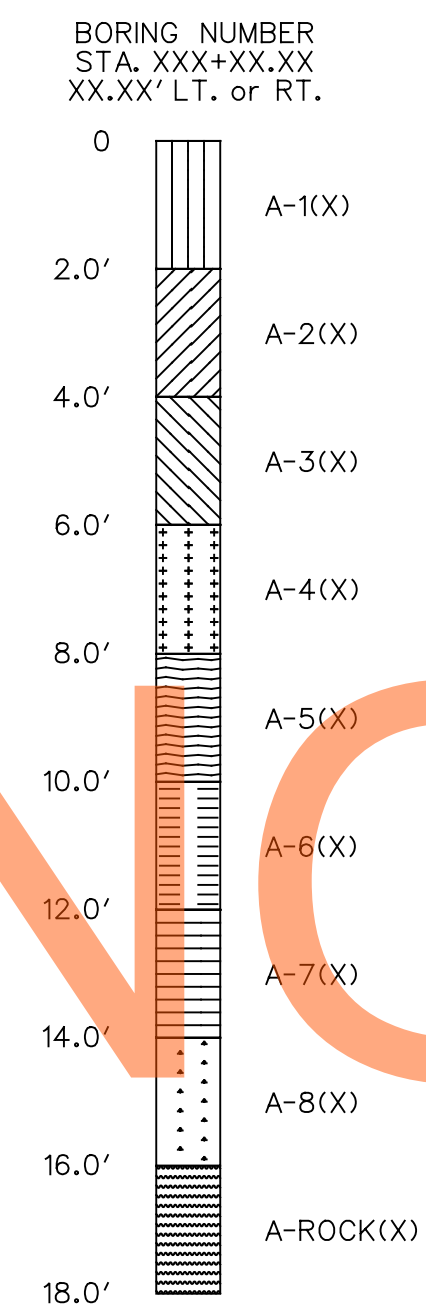

MDSHA BORING LEGEND

DELDOT BORING LEGEND

NOT FOR BIDDING

AUGUST 2015

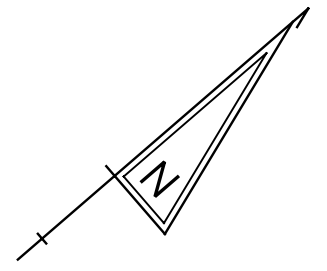

**BEGIN
CONTRACT T200811301
STATION 102+95**

US 301 CONSTRUCTION

SS3-11-01 AND SS3-12-01 ARE LOCATED ADJACENT TO NB 301 SOUTH OF CURRENT PROJECT MAPPING APPROXIMATELY 1500' AND 500' SOUTH OF THE MAINLINE WEIGH IN MOTION SCALE, RESPECTIVELY. SEE MATRIX FOR N/E INFORMATION.

DRAFT

NOT FOR BIDDING

AUGUST 2015

MATCHLINE STA. 120+00

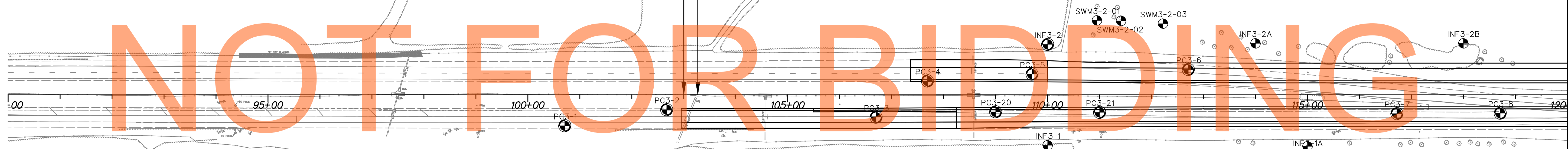

ADDENDUMS / REVISIONS	

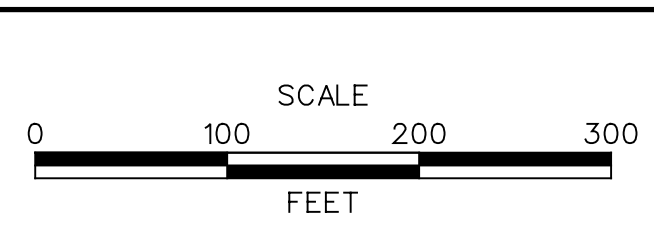

CONTRACT T200811301	BRIDGE NO.
COUNTY NEW CASTLE	DESIGNED BY: MAG/TAM
	CHECKED BY: PAH

DRAFT

NOT FOR BIDDING

AUGUST 2015

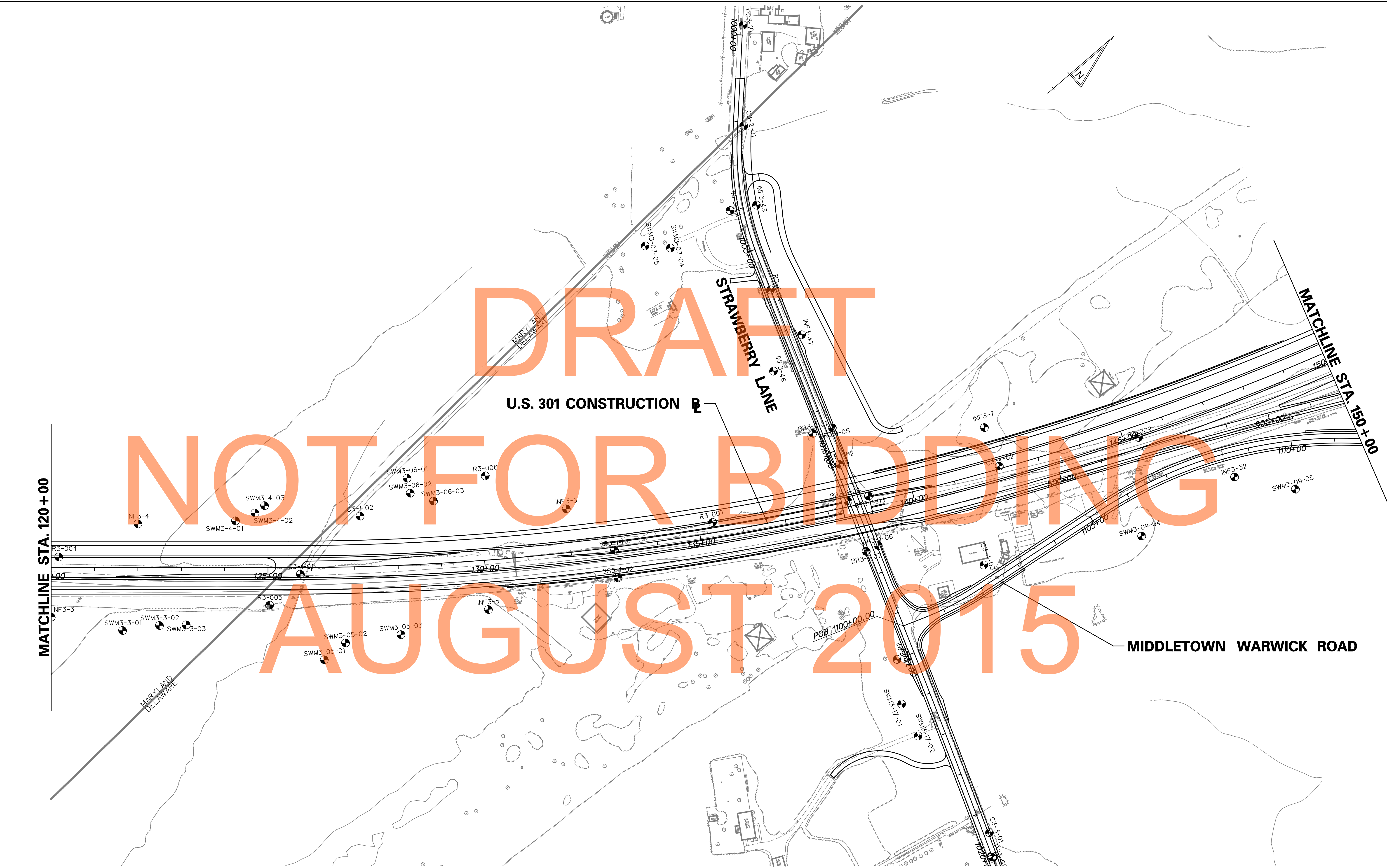

ADDENDUMS / REVISIONS	

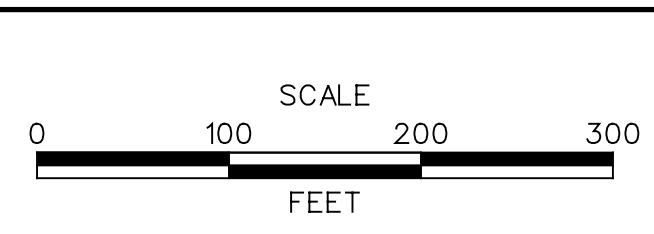

CONTRACT T200811301	BRIDGE NO.
COUNTY NEW CASTLE	DESIGNED BY: MAG/TAM
	CHECKED BY: PAH

BORING LOCATIONS	SHEET NO.
	4
BORING LOCATIONS	TOTAL SHTS.
	9

DRAFT
U.S. 301 CONSTRUCTION

NOT FOR BIDDING
AUGUST 2015

MATCHLINE STA. 150+00

MATCHLINE STA. 180+00

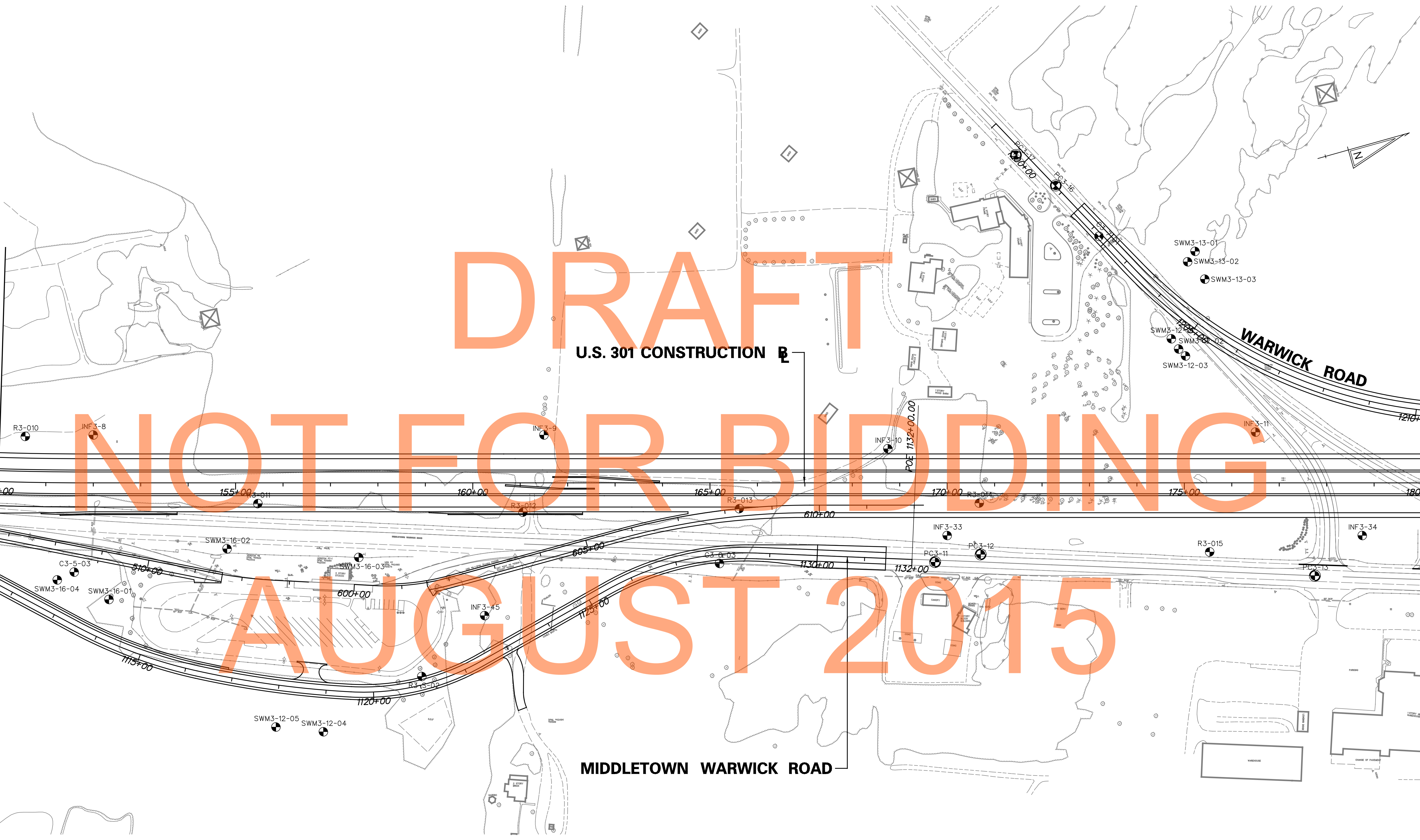

ADDENDUMS / REVISIONS	

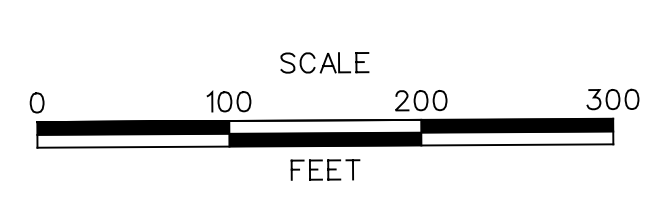

CONTRACT T200811301	BRIDGE NO.
COUNTY NEW CASTLE	DESIGNED BY: MAG/TAM
	CHECKED BY: PAH

BORING LOCATIONS	SHEET NO. 5
	TOTAL SHTS. 9

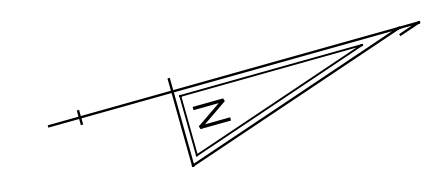

DRAFT

NOT FOR BIDDING

AUGUST 2015

U.S. 301 CONSTRUCTION

WARWICK ROAD

MIDDLETOWN WARWICK ROAD

MATCHLINE STA. 180 + 00

MATCHLINE STA. 210 + 00



ADDENDUMS / REVISIONS	

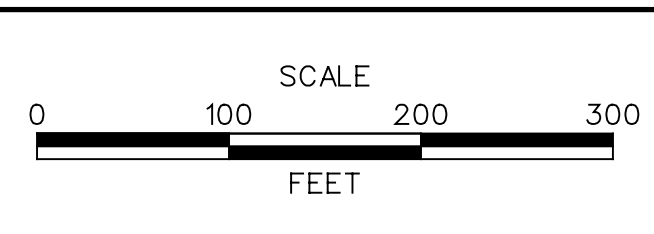

US 301
MARYLAND STATE LINE
TO LEVELS ROAD

CONTRACT T200811301	BRIDGE NO.
COUNTY NEW CASTLE	DESIGNED BY: MAG/TAM
	CHECKED BY: PAH

BORING LOCATIONS	SHEET NO. 6
	TOTAL SHTS. 9

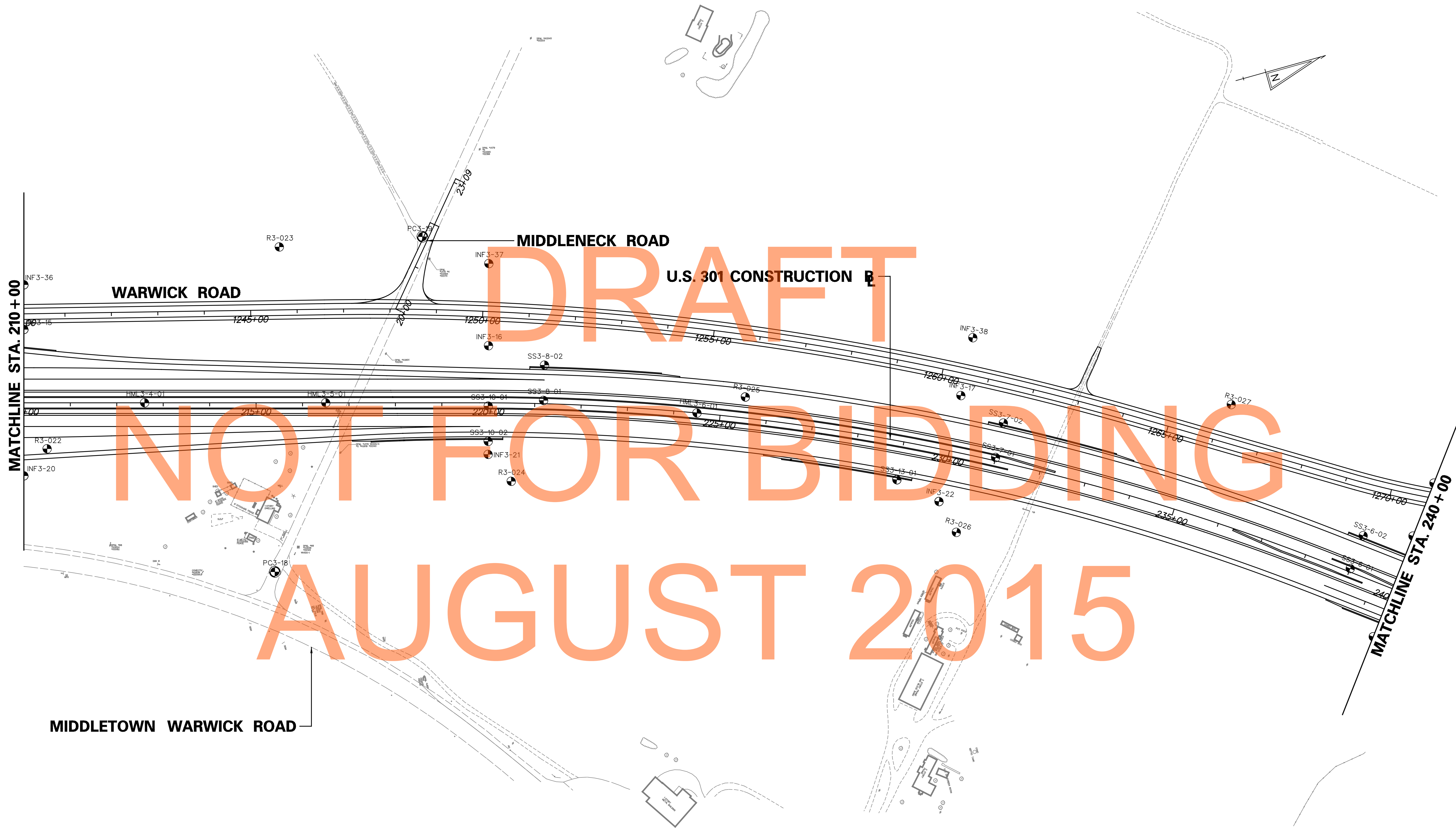

ADDENDUMS / REVISIONS	

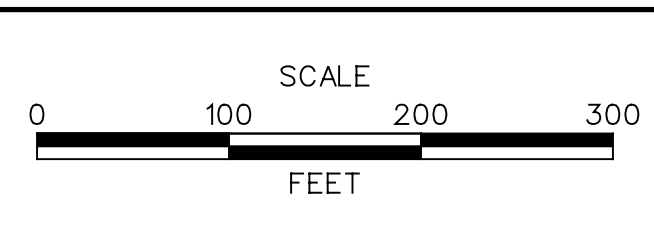

US 301
MARYLAND STATE LINE
TO LEVELS ROAD

CONTRACT T200811301	BRIDGE NO.
COUNTY NEW CASTLE	DESIGNED BY: MAG/TAM
	CHECKED BY: PAH

BORING LOCATIONS

SHEET NO. 7
TOTAL SHTS. 9

DRAFT
NOT FOR BIDDING
AUGUST 2015

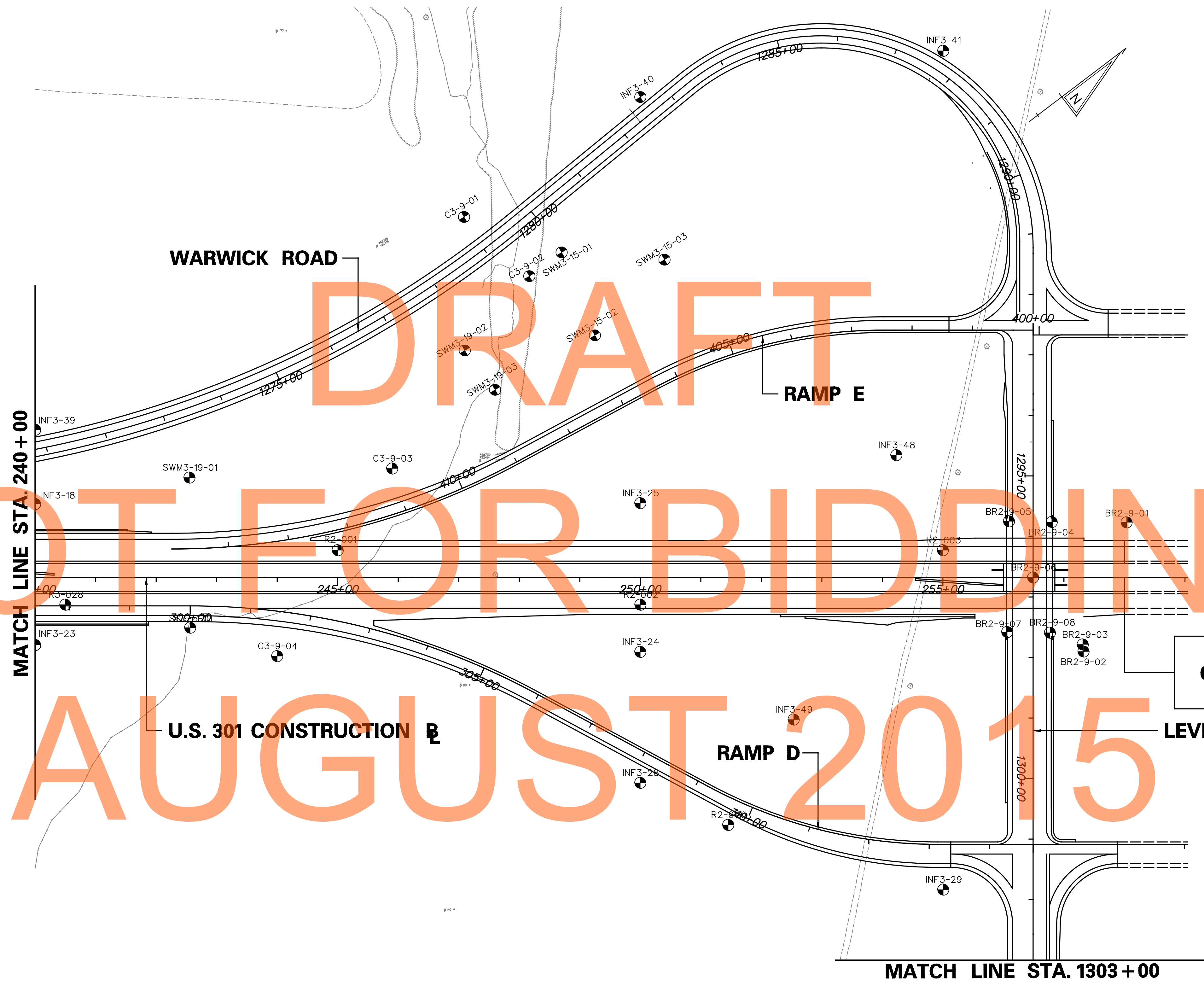

END
CONTRACT T200811301
STATION 258+00

ADDENDUMS / REVISIONS

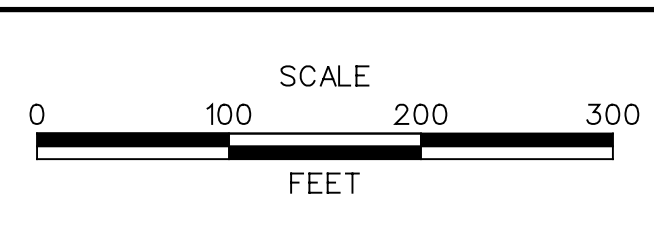

US 301
MARYLAND STATE LINE
TO LEVELS ROAD

CONTRACT T200811301	BRIDGE NO.
COUNTY NEW CASTLE	DESIGNED BY: MAG/TAM CHECKED BY: PAH

BORING LOCATIONS

SHEET NO. 8
TOTAL SHTS. 9

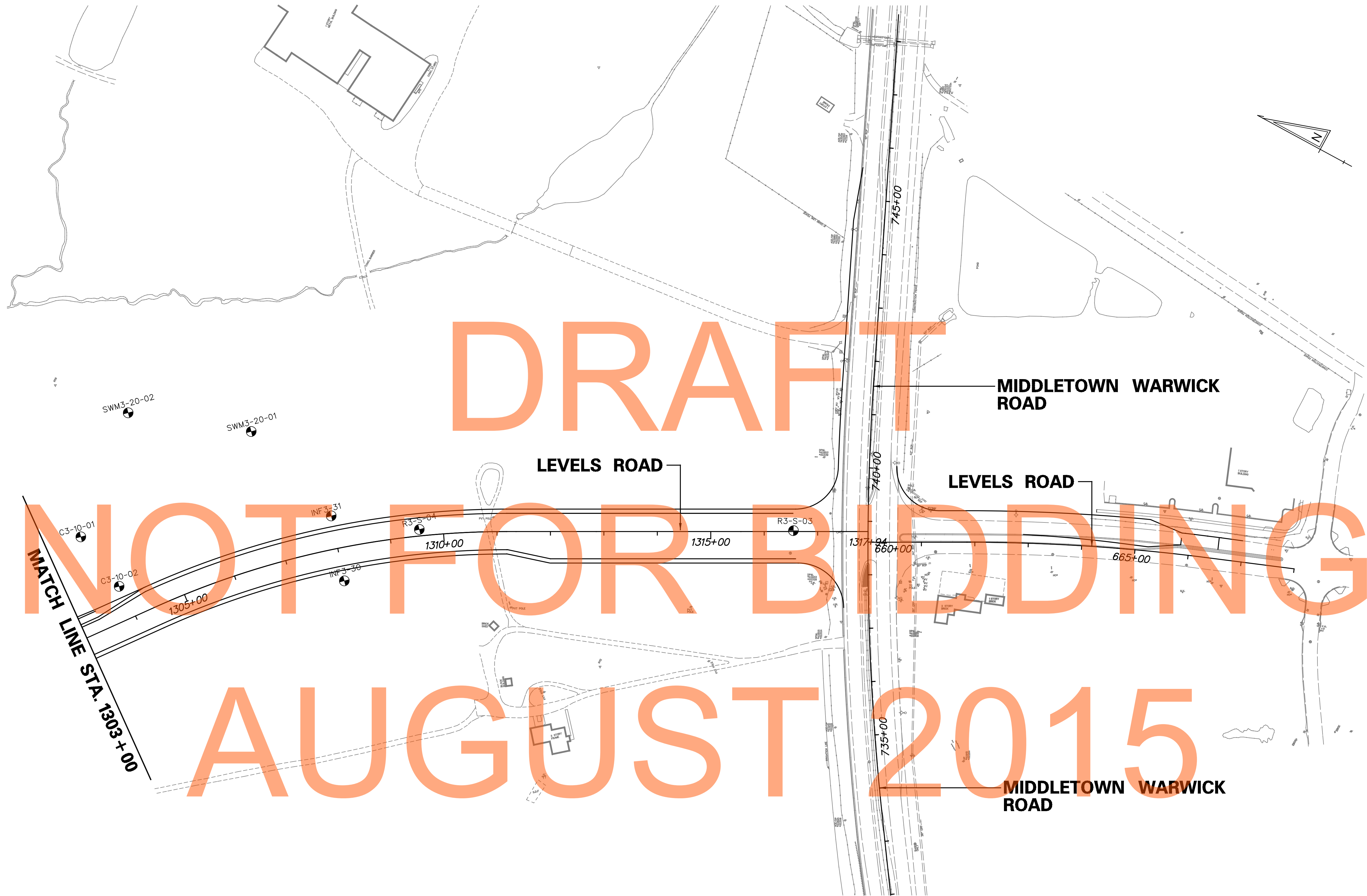

DRAFT
NOT FOR BIDDING
AUGUST 2015

ADDENDUMS / REVISIONS	

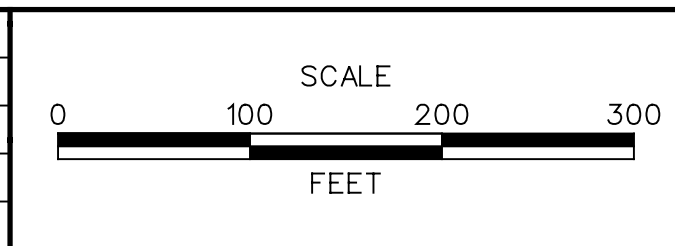

US 301
MARYLAND STATE LINE
TO LEVELS ROAD

CONTRACT T200811301	BRIDGE NO.
COUNTY NEW CASTLE	DESIGNED BY: MAG/TAM
	CHECKED BY: PAH

BORING LOCATIONS	SHEET NO.
	TOTAL SHTS.
	9

9
9